

Integrating the Healthcare Enterprise



5

**IHE Radiation Oncology (RO)
Technical Framework**

10

**Volume 1
IHE RO TF-1
Profiles**

15

20

**Revision 2.0 - Final Text
April 7, 2020**

25

Please verify you have the most recent version of this document, which is published [here](#).

CONTENTS

	1	Introduction.....	4
		1.1 Introduction to IHE.....	4
30		1.2 Introduction to IHE Radiation Oncology Domain (RO)	4
		1.3 Intended Audience	4
		1.4 Prerequisites and Reference Material	5
		1.4.1 Actor Descriptions.....	5
		1.4.2 Transaction Descriptions	5
35		1.4.3 IHE Integration Statements.....	5
		1.5 Overview of Technical Framework Volume 1	5
		1.6 Comment Process.....	6
		1.7 Copyright Licenses	6
		1.7.1 Copyright of Base Standards	6
40		1.8 Trademark.....	7
		1.9 Disclaimer Regarding Patent Rights.....	7
		1.10 History of Document Changes.....	8
	2	Radiation Oncology Integration Profiles	9
		2.1 Dependencies among Integration Profiles	9
45		2.2 Integration Profiles Overview.....	10
		2.2.1 This section is reserved.....	11
		2.2.2 This section is reserved.....	11
	3	Basic Radiation Therapy Objects Integration Profile II (BRTO-II)	12
		3.1 Actors / Transactions	12
50		3.1.1 Actor Descriptions and Actor Profile Requirements.....	14
		3.2 Basic RT Objects Integration Profile Options	15
		3.3 BRTO II Required Actor Groupings.....	15
		3.4 BRTO II Overview	15
		3.4.1 Concepts	15
55		3.4.2 Use Cases.....	16
		3.5 BRTO II Security Considerations.....	19
		3.6 BRTO II Cross Profile Considerations	19
	4	Multimodality Image Registration for Radiation Oncology 2018 (MMRO-III) Profile	20
		4.1 Actors / Transactions	20
60		4.1.1 Actor Descriptions and Actor Profile Requirements.....	22
		4.2 MMRO-III Actor Options.....	23
		4.3 MMRO-III Actor Required Groupings.....	24
		4.4 MMRO-III Overview.....	24
		4.4.1 Concepts	24
65		4.4.2 Use Cases.....	28
		4.5 MMRO-III Security Considerations	32
		4.6 MMRO-III Cross Profile Considerations.....	32
	5	Treatment Planning – Plan Content Integration (TPPC) Profile.....	33

	5.1 Actors / Transactions	33
70	5.1.1 Actor Descriptions and Actor Profile Requirements.....	37
	5.2 TPPC Transaction Options.....	37
	5.2.1 Producer / Consumer Transaction Groupings.....	40
	5.3 TPPC Actor Required Groupings.....	40
	5.4 TPPC Overview	40
75	5.4.1 Concepts	41
	5.4.2 Use Cases	43
	5.5 TPPC Security Considerations.....	44
	5.6 TPPC Cross Profile Considerations	45
	Appendices.....	46
80	Appendix A – Actor Descriptions.....	46
	Appendix B – Transactions.....	50
	IHE Glossary.....	55
	Radiation Oncology Glossary Terms	55

85

1 Introduction

This document, Volume 1 of the IHE Radiation Oncology (RO) Technical Framework, describes the clinical use cases, actors, content module, and transaction requirements for the Radiation Oncology profiles.

90 1.1 Introduction to IHE

Integrating the Healthcare Enterprise (IHE) is an international initiative to promote the use of standards to achieve interoperability among health information technology (HIT) systems and effective use of electronic health records (EHRs). IHE provides a forum for care providers, HIT experts and other stakeholders in several clinical and operational domains to reach consensus on standards-based solutions to critical interoperability issues.

95 The primary output of IHE is system implementation guides, called IHE profiles. IHE publishes each profile through a well-defined process of public review and Trial Implementation and gathers profiles that have reached Final Text status into an IHE Technical Framework, of which this volume is a part.

100 For general information regarding IHE, refer to www.ihe.net. It is strongly recommended that, prior to reading this volume, the reader familiarizes themselves with the concepts defined in the [IHE Technical Frameworks General Introduction](#).

1.2 Introduction to IHE Radiation Oncology Domain (RO)

105 In support of IHE aims, The American Association of Physicists in Medicine American Society for Radiology Oncology (AAPM) supports a multi-society Task Force and the IHE Radiation Oncology Planning and Technical Committees to undertake an initiative to promote seamless connectivity and integration of radiotherapy equipment and the patient health information systems.

110 The Task Force will include members from ASTRO, RSNA, AAPM, the American College of Radiology (ACR) and the Medical Imaging and Technology Alliance (MITA). In addition, members of the International community have also been invited to participate in IHE-RO Planning and Technical Committees. The IHE-RO Task Force, in close collaboration with radiotherapy product manufacturers, will oversee development of appropriate integration profiles for radiation therapy and setup a demonstration of seamless communication among the full array of radiotherapy products.

1.3 Intended Audience

The intended audience of IHE Technical Frameworks Volume 1 (Profiles) is:

- Those interested in integrating healthcare information systems and workflows
- IT departments of healthcare institutions
- 120 • Technical staff of vendors participating in the IHE initiative

1.4 Prerequisites and Reference Material

For more general information regarding IHE, refer to www.ihe.net. It is strongly recommended that, prior to reading this volume, the reader familiarizes themselves with the concepts defined in the *[IHE Technical Frameworks General Introduction](#)*.

125 Additional reference material available includes:

1.4.1 Actor Descriptions

Actors are information systems or components of information systems that produce, manage, or act on information associated with operational activities in the enterprise.

A list of Radiation Oncology actors is available in [Appendix A](#) of this RO Volume 1 document

130 A list of actors defined for all other domains and their brief descriptions can be found as [Appendix A](#) to the *IHE Technical Frameworks General Introduction*.

1.4.2 Transaction Descriptions

Transactions are interactions between actors that transfer the required information through standards-based messages.

135 A list of Radiation Oncology transactions is available in [Appendix B](#) of this RO Volume 1 document.

A list of transactions defined for all other domains, their transactions numbers, and a brief description can be found as [Appendix B](#) to the *IHE Technical Frameworks General Introduction*.

1.4.3 IHE Integration Statements

140 IHE Integration Statements provide a consistent way to document high level IHE implementation status in products between vendors and users.

The instructions and template for IHE Integration Statements can be found as [Appendix F](#) to the *IHE Technical Frameworks General Introduction*.

145 IHE also provides the IHE Product Registry (http://www.ihe.net/IHE_Product_Registry) as a resource for vendors and purchasers of HIT systems to communicate about the IHE compliance of such systems. Vendors can use the Product Registry to generate and register Integration Statements.

1.5 Overview of Technical Framework Volume 1

Volume 1 is comprised of several distinct sections:

- 150
- Section 1 provides background and reference material.
 - Section 2 presents the conventions used in this volume to define the profiles.
 - Sections 3 and beyond define Radiation Oncology profiles, actors, and requirements in detail.

The appendices in Volume 1 provide clarification of uses cases or other details.

155 A glossary of terms and acronyms used in the IHE Technical Framework is provided in
[Appendix D](#) to the *IHE Technical Frameworks General Introduction*.
Radiation Oncology Glossary terms are available in this document [here](#).

1.6 Comment Process

160 AAPM welcomes comments on this document and the IHE-RO initiative. They should be
submitted at http://www.ihe.net/Radiation_Oncology_Public_Comments or to:

Jill I. Moton, MBA
Program Manager
American Association of Physicists in Medicine (AAPM)
1631 Prince Street
165 Alexandria, VA 22314 jill@aapm.org

1.7 Copyright Licenses

170 IHE International hereby grants to each Member Organization, and to any other user of these
documents, an irrevocable, worldwide, perpetual, royalty-free, nontransferable, nonexclusive,
non-sublicensable license under its copyrights in any IHE profiles and Technical Framework
documents, as well as any additional copyrighted materials that will be owned by IHE
International and will be made available for use by Member Organizations, to reproduce and
distribute (in any and all print, electronic or other means of reproduction, storage or
transmission) such IHE Technical Documents.

175 The licenses covered by this Copyright License are only to those copyrights owned or controlled
by IHE International itself. If parts of the Technical Framework are included in products that also
include materials owned or controlled by other parties, licenses to use those products are beyond
the scope of this IHE document and would have to be obtained from that other party.

1.7.1 Copyright of Base Standards

180 IHE technical documents refer to and make use of a number of standards developed and
published by several standards development organizations. All rights for their respective base
standards are reserved by these organizations. This agreement does not supersede any copyright
provisions applicable to such base standards. Copyright license information for frequently
referenced base standards is provided below.

1.7.1.1 DICOM (Digital Imaging and Communications in Medicine)

185 DICOM[®] is the registered trademark of the National Electrical Manufacturers Association for its
standards publications relating to digital communications of medical information.

1.7.1.2 HL7 (Health Level Seven)

HL7[®], Health Level Seven[®], CDA[®], FHIR[®], and the FHIR [FLAME DESIGN][®] are registered
trademarks of Health Level Seven International.

190 Health Level Seven, Inc. has granted permission to IHE to reproduce tables from the HL7 standard. The HL7 tables in this document are copyrighted by Health Level Seven, Inc. All rights reserved. Material drawn from these documents is credited where used.

1.7.1.3 LOINC (Logical Observation Identifiers Names and Codes)

LOINC[®] is registered United States trademarks of Regenstrief Institute, Inc.

195 1.7.1.4 SNOMED CT (Systematized Nomenclature of Medicine -- Clinical Terms)

Some IHE Profiles incorporate SNOMED[®] CT, which is used by permission of the International Health Terminology Standards Development Organisation. SNOMED CT[®] was originally created by the College of American Pathologists. SNOMED CT is a registered trademark of the International Health Terminology Standards Development Organisation, all rights reserved.

200 1.7.1.5 National Electrical Manufacturers Association (NEMA)

The National Electrical Manufacturers Association (NEMA) has granted permission to IHE to incorporate portions of the DICOM standard. Material drawn from these documents is credited where used.

1.8 Trademark

205 IHE[®] and the IHE logo are trademarks of the Healthcare Information Management Systems Society in the United States and trademarks of IHE Europe in the European Community. They may only be used with the written consent of the IHE International Board Operations Committee, which may be given to a Member Organization in broad terms for any use that is consistent with the IHE mission and operating principles.

210 1.9 Disclaimer Regarding Patent Rights

Attention is called to the possibility that implementation of the specifications in this document may require use of subject matter covered by patent rights. By publication of this document, no position is taken with respect to the existence or validity of any patent rights in connection therewith. IHE International is not responsible for identifying Necessary Patent Claims for which
215 a license may be required, for conducting inquiries into the legal validity or scope of Patents Claims or determining whether any licensing terms or conditions provided in connection with submission of a Letter of Assurance, if any, or in any licensing agreements are reasonable or non-discriminatory. Users of the specifications in this document are expressly advised that determination of the validity of any patent rights, and the risk of infringement of such rights, is
220 entirely their own responsibility. Further information about the IHE International patent disclosure process including links to forms for making disclosures is available at http://www.ihe.net/Patent_Disclosure_Process. Please address questions about the patent disclosure process to the secretary of the IHE International Board: secretary@ihe.net.

225 **1.10 History of Document Changes**

This section provides a brief summary of changes and additions to this document.

Date	Document Revision	Change Summary
2007		Initiated the IHE Radiation Oncology Technical Frameworks with the <i>Basic Radiation Therapy Objects</i> Integration Profile (BRTO).
2011		Updated the front matter sections of Volumes 1 and 2 of the IHE Radiation Oncology Technical Frameworks to be consistent with newly released domain-wide sections.
2014		Updated Volumes 1 and 2 of the IHE Radiation Oncology Technical Frameworks to include approved 2013 change proposals and technical frameworks formatting changes.
2020	2.0	Updated Volumes 1 and 2 of the IHE Radiation Oncology Technical Frameworks to include profiles voted to Final Text Also initiated a Volume 3 to include DICOM Content Modules. Updated format of Section 1 to match current released Volume 1 template.

2

2 Radiation Oncology Integration Profiles

230 IHE Radiation Oncology Integration Profiles (Figure 2-1), offer a common language that
healthcare professionals and vendors can use to discuss integration needs of healthcare
enterprises and the integration capabilities of information systems in precise terms. Integration
Profiles specify implementations of standards that are designed to meet identified clinical needs.
235 They enable users and vendors to state which IHE capabilities they require or provide, by
reference to the detailed specifications of the IHE Radiation Oncology Technical Framework.

Integration profiles are defined in terms of IHE actors and transactions. Actors (see RO TF-1:
Appendix A) are information systems or components of information systems that produce,
manage, or act on information associated with clinical and operational activities in the enterprise.
240 Transactions (see RO TF-1: Appendix B) are interactions between actors that communicate the
required information through standards-based messages.

Vendor products support an Integration Profile by implementing the appropriate actor(s) and
transactions. A given product may implement more than one actor and more than one integration
profile. Some profiles are content only and are vehicles for defining how attributes and values
are grouped to give useful backing to the other, workflow-based profiles.

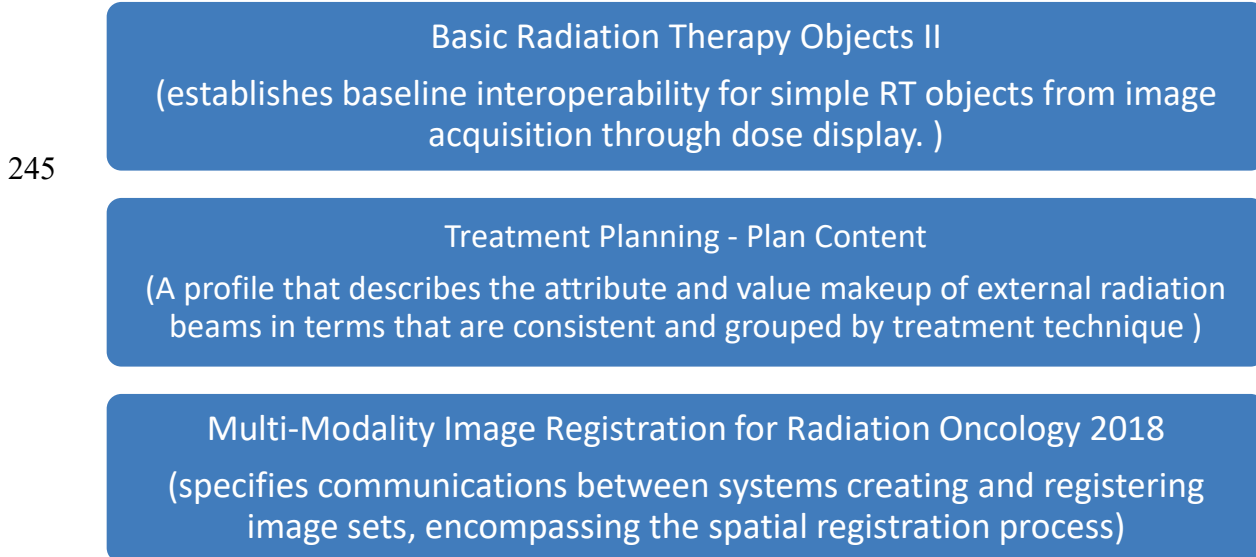

Figure 2-1: IHE Radiation Oncology Integration Profiles

2.1 Dependencies among Integration Profiles

250 Dependencies among IHE Integration Profiles exist when implementation of one integration
profile is a prerequisite for achieving the functionality defined in another integration profile.
Figure 2-1 provides a graphical view of the dependencies among IHE Radiation Oncology
Integration Profiles and between IHE RO Integration Profiles and Integration Profiles from other
domains (such as Radiology). The arrows in the figure point from a given integration profile to
255 the integration profile(s) upon which it depends. Table 2.1-1 defines these dependencies in
tabular form.

260 Some dependencies require that an actor supporting one profile be grouped with one or more actors supporting other integration profiles. For example (see the ITI TF), Enterprise User Authentication (EUA) requires that different actors be grouped with the Time Client Actor that participates in the Consistent Time (CT) Integration Profile. The dependency exists because EUA Actors must refer to consistent time in order to function properly.

Table 2.1-1: Integration Profiles Dependencies

Integration Profile	Depends on	Dependency Type	Purpose
Basic Radiation Therapy Objects II	Scheduled Workflow	Acquisition Modality Image Storage (RAD-8)	CT Images will be stored in the archive in accordance with the referenced transaction
Multimodality Image Registration for Radiation Oncology 2018	Scheduled Workflow	Acquisition Modality Image Storage (RAD-8)	Modality Images (CT, MR, PT...) will be stored in the archive in accordance with the referenced transaction
Multimodality Image Registration for Radiation Oncology 2018	Scheduled Workflow	Creator Images Stored (RAD-18)	Created Images (CT, MR, PT...) will be stored in the archive in accordance with the referenced transaction
Multimodality Image Registration for Radiation Oncology 2018	Basic Radiation Therapy Objects II	Dose Storage [RO-5]	RT Dose will be stored in the archive in accordance with the referenced transaction

265 To support a dependent profile, an actor must implement all required transactions in the prerequisite profiles in addition to those in the dependent profile. In some cases, the prerequisite is that the actor selects any one of a given set of profiles.

2.2 Integration Profiles Overview

In this document, each IHE Integration Profile is defined by:

- The IHE actors involved
- 270 • The specific set of IHE transactions exchanged by each IHE actor.

Some supplements to the Technical Framework are Content Profiles, their main effect is to add consistent sets of attribute descriptions to Volume 3 of the Technical Framework.

275 These requirements are presented in the form of a table of transactions required for each actor supporting the Integration Profile. Actors supporting multiple Integration Profiles are required to support all the required transactions of each Integration Profile supported. When an Integration Profile depends upon another Integration Profile, the transactions required for the dependent Integration Profile have not been included in the table.

280 Note that IHE Integration Profiles are not statements of conformance to standards, and IHE is not a certifying body. Users should continue to request that vendors provide statements of their conformance to standards issued by relevant standards bodies, such as HL7 and DICOM. Standards conformance is a prerequisite for vendors adopting IHE Integration Profiles.

285 Also note that there are critical requirements for any successful integration project that IHE cannot address. Successfully integrating systems still requires a project plan that minimizes disruptions and describes fail-safe strategies, specific and mutually understood performance expectations, well-defined user interface requirements, clearly identified systems limitations, detailed cost objectives, plans for maintenance and support, etc.

2.2.1 This section is reserved.

2.2.2 This section is reserved.

3 Basic Radiation Therapy Objects Integration Profile II (BRTO-II)

290 The *Basic Radiation Therapy Objects II* Integration Profile involves the flow of DICOM^{®1} images and treatment planning data, from CT scan through dose display, for 3D conformal, external beam radiation therapy. Detailed plan content for different types of delivery are specified in separate profiles. The emphasis for this integration profile is on reducing ambiguity and facilitating basic interoperability in the exchange of DICOM RT objects.

295 The BRTO II Profile has the following implications:

- All related DICOM objects (CT images, RT Structure Sets, RT Plans, and RT Doses) are required to be in the same frame of reference and have the same Frame of Reference UID.
- The orientation of images, structures, plans, and doses must be consistent, with the exception that head-first/feet-first directions may be altered between scans and treatment delivery.

The profile also addresses some capabilities that have been shown to affect interoperability of applications during the Radiation Oncology Treatment Planning Process. The issues addressed include the following:

- 305 • Variable Slice Spacing – As above, CT devices may produce image datasets with different slice spacing within a single series. All applications must be able to accept such datasets.
- If a Contourer creates an RT Structure Set based on a resampled image set, the Contourer must be able to store the resampled image
- 310 • Dose Grid Spacing – Many applications are capable of producing RT Dose objects with different spacing in the X, Y, and Z dimensions. This implies that dose grids are regular inplane, but not guaranteed to have equal row and column spacing. Z-spacing (slice spacing) can be different from the X and Y spacing. This profile requires equidistant Z-spacing for the RT Dose.

315 3.1 Actors / Transactions

Table 3.1-1 lists the transactions for each actor directly involved in the *Basic Radiation Therapy Objects II* Integration Profile. In order to claim support of this Integration Profile, an implementation must perform the required transactions (labeled “R”). A complete list of options defined by this Integration Profile and that implementations may choose to support is listed in IHE RO TF-1: 3.2.

¹ DICOM is the registered trademark of the National Electrical Manufacturers Association for its standards publications relating to digital communications of medical information.

Table 3.1-1: Basic RT Objects Integration Profile II - Actors and Transactions

Actors	Transactions	Optionality	Section
Archive	Single/Contoured Series Image Retrieval [RO-1]	R	RO TF-2: 3.1
	Structure Set Storage [RO-2]	R	RO TF-2: 3.2
	Off-slice Structure Set Storage [RO-BRTO-II-1]	R	RO TF-2: 3.3
	Dosimetric Plan Storage [RO-4]	R	RO TF-2: 3.4
	Dose Storage [RO-BRTO-II-5]	R	RO TF-2: 3.5
	DVH Dose Storage [RO-BRTO-II-3]	R	RO TF-2: 3.6
	Structure Set Retrieval [RO-7]	R	RO TF-2: 3.7
	Off-slice Structure Set Retrieval [RO-BRTO-II-2]	R	RO TF-2: 3.8
	Geometric Plan Retrieval [RO-8]	R	RO TF-2: 3.9
	Dosimetric Plan Retrieval [RO-9]	R	RO TF-2: 3.10
	Dose Retrieval [RO-BRTO-II-6]	R	RO TF-2: 3.11
	DVH Dose Retrieval [RO-BRTO-II-4]	R	RO TF-2: 3.12
Resampled/Combined CT Series Storage [RO-11]	R	RO TF-2: 3.13	
Contourer	Single/Contoured Series Image Retrieval [RO-1]	R	RO TF-2: 3.1
	Structure Set Storage [RO-2]	R	RO TF-2: 3.2
	Off-slice Structure Set Storage [RO-BRTO-II-1]	O	RO TF-2: 3.3
	Structure Set Retrieval [RO-7]	O	RO TF-2: 3.7
	Off-slice Structure Set Retrieval [RO-BRTO-II-2]	O	RO TF-2: 3.8
	Resampled/Combined CT Series Storage [RO-11]	O	RO TF-2: 3.13
Dosimetric Planner	Dosimetric Plan Storage [RO-4]	R	RO TF-2: 3.4
	Dose Storage [RO-BRTO-II-5]	R	RO TF-2: 3.5
	DVH Dose Storage [RO-BRTO-II-3]	O	RO TF-2: 3.6
	Structure Set Storage [RO-2]	R	RO TF-2: 3.2
	Off-slice Structure Set Storage [RO-BRTO-II-1]	O	RO TF-2: 3.3
	Geometric Plan Retrieval [RO-8]	O	RO TF-2: 3.9
	Structure Set Retrieval [RO-7]	R	RO TF-2: 3.7
	Off-slice Structure Set Retrieval [RO-BRTO-II-2]	O	RO TF-2: 3.8
	Single/Contoured Series Image Retrieval [RO-1]	R	RO TF-2: 3.1
	Resampled/Combined CT Series Storage [RO-11]	O	RO TF-2: 3.13
Dose Displayer	Dose Retrieval [RO-BRTO-II-6]	R	RO TF-2: 3.11
	DVH Dose Retrieval [RO-BRTO-II-4]	O	RO TF-2: 3.12
	Dosimetric Plan Retrieval [RO-9]	R	RO TF-2: 3.10
	Structure Set Retrieval [RO-7]	R	RO TF-2: 3.7
	Off-slice Structure Set Retrieval [RO-BRTO-II-2]	O	RO TF-2: 3.8
	Single/Contoured Series Image Retrieval [RO-1]	R	RO TF-2: 3.1

Figure 3.1-1 shows the actors directly involved in the *Basic RT Objects II* Integration Profile and the relevant transactions between them. Other actors that may be indirectly involved due to their participation in *Scheduled Workflow* are not necessarily shown.

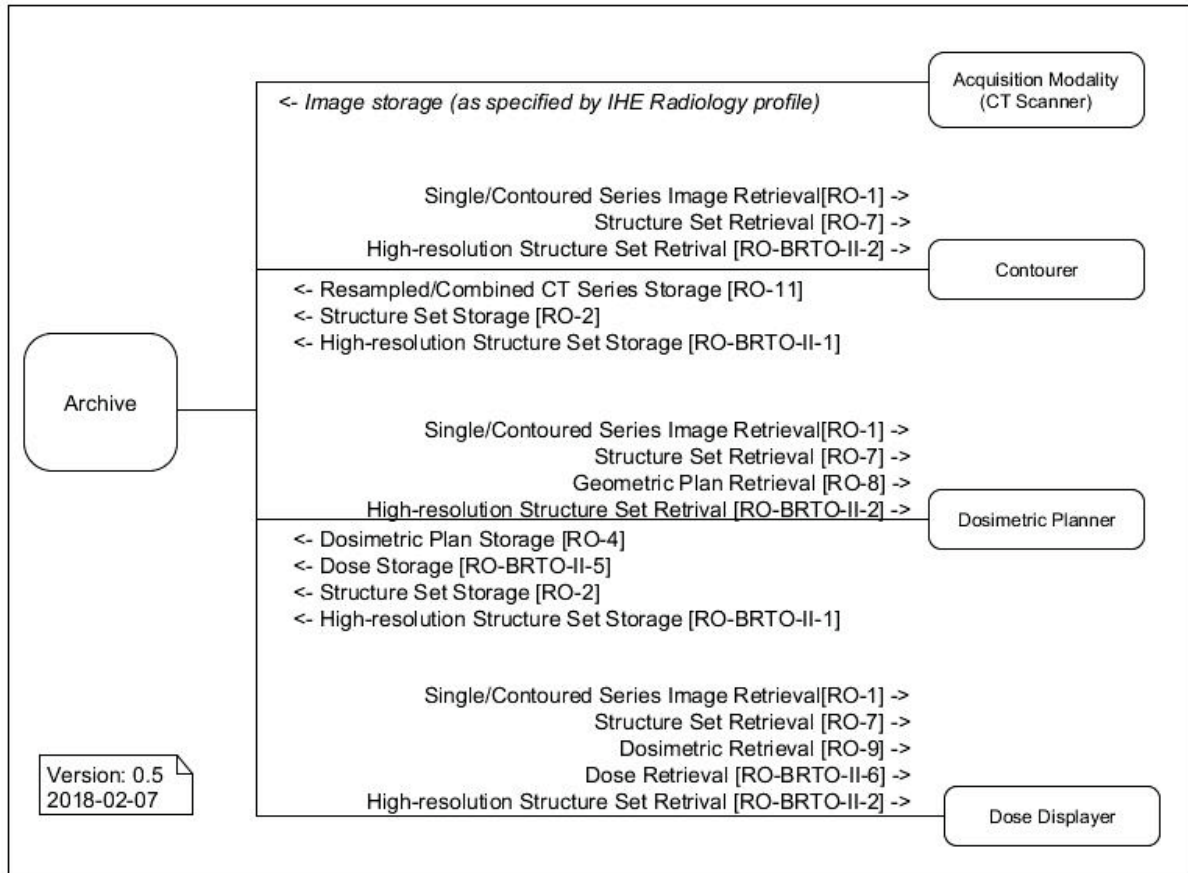

330

Figure 3.1-1: Basic RT Objects Actor Diagram

3.1.1 Actor Descriptions and Actor Profile Requirements

Most requirements are documented in Transactions (Volume 2) and Content Modules (Volume 3). This section documents any additional requirements on profile's actors.

335 **Acquisition Modality** – A system that acquires and creates medical images while a patient is present, e.g., a Computed Tomography scanner or Nuclear Medicine camera. A modality may also create other evidence objects such as Grayscale Softcopy Presentation States for the consistent viewing of images or Evidence Documents containing measurements.

Archive – A system that provides long term storage of evidence objects such as images, presentation states, Key Image Notes and Evidence Documents.

340 **Contourer** – A system that consumes one or more CT image series and creates an RT Structure Set. If the Contourer consumes multiple CT image series or has an internal requirement for

resampling, it also will generate a single CT image series to which the RT Structure Set maps. A Contourer shall be able to consume CT image series with non-uniform spacing.

345 **Dosimetric Planner** – A system that consumes a single CT image series, an RT Structure Set, and a Geometric Plan and creates a Dosimetric Plan and an RT Dose.

Archive (including RT) – A system that stores the RT SOP Classes in addition to the CT images and is capable of transmitting them.

Dose Displayer – A system that consumes a Dosimetric Plan, a single CT image series, an RT Structure Set, and an RT Dose and displays the dose.

350 3.2 Basic RT Objects Integration Profile Options

Options that may be selected for this Integration Profile are listed in Table 3.2-1 along with the IHE actors to which they apply. Dependencies between options when applicable are specified in notes.

Table 3.2-1: Basic RT Objects - Actors and Options

Actor	Options	Vol & Section
Archive	<i>None</i>	--
Contourer	<i>Feet First, Decubitus</i>	See RO TF-3: 7.3.3.2.3
	<i>Off-Slice Structure Set</i>	See RO TF-3: 7.3.4.1.1
	<i>Resampled/ Combined CT Storage</i>	See RO TF-2: 3.13
Dosimetric Planner	<i>Feet First, Reoriented*, Decubitus</i>	See RO TF-3: 7.3.2.2.1 (RT Plan)
	<i>Off-Slice Structure Set</i>	See RO TF-3: 7.3.4.1.1
	<i>DVH Dose</i>	See RO TF-3: 7.3.5.1.1
Dose Displayer	<i>Resampled/ Combined CT Storage</i>	See RO TF-2: 3.13
	<i>Off-Slice Structure Set</i>	See RO TF-3: 7.3.4.1.1
	<i>DVH Dose</i>	See RO TF-3: 7.3.5.1.1

355 *Reoriented: Patient position in treatment setup differs from image patient position. This option is restricted to HFS/HFP/FFS/FFP.

3.3 BRTO II Required Actor Groupings

None.

360 3.4 BRTO II Overview

3.4.1 Concepts

Basic Radiation Therapy Objects II involves the flow of DICOM images and treatment planning data, from image contouring through dose display, for external beam radiation therapy based on

365 volumetric images. The emphasis for this Integration Profile is on reducing ambiguity and facilitating basic interoperability in the exchange of DICOM RT objects.

Structures used within the scope of this profile may be drawn on a CT slice (on-slice contour) or optionally between the CT slices (off-slice contour). Off-slice contouring may be used to represent more detailed structural information. Such information may come from other imaging modalities or from processing CT-derived structures.

370 **3.4.2 Use Cases**

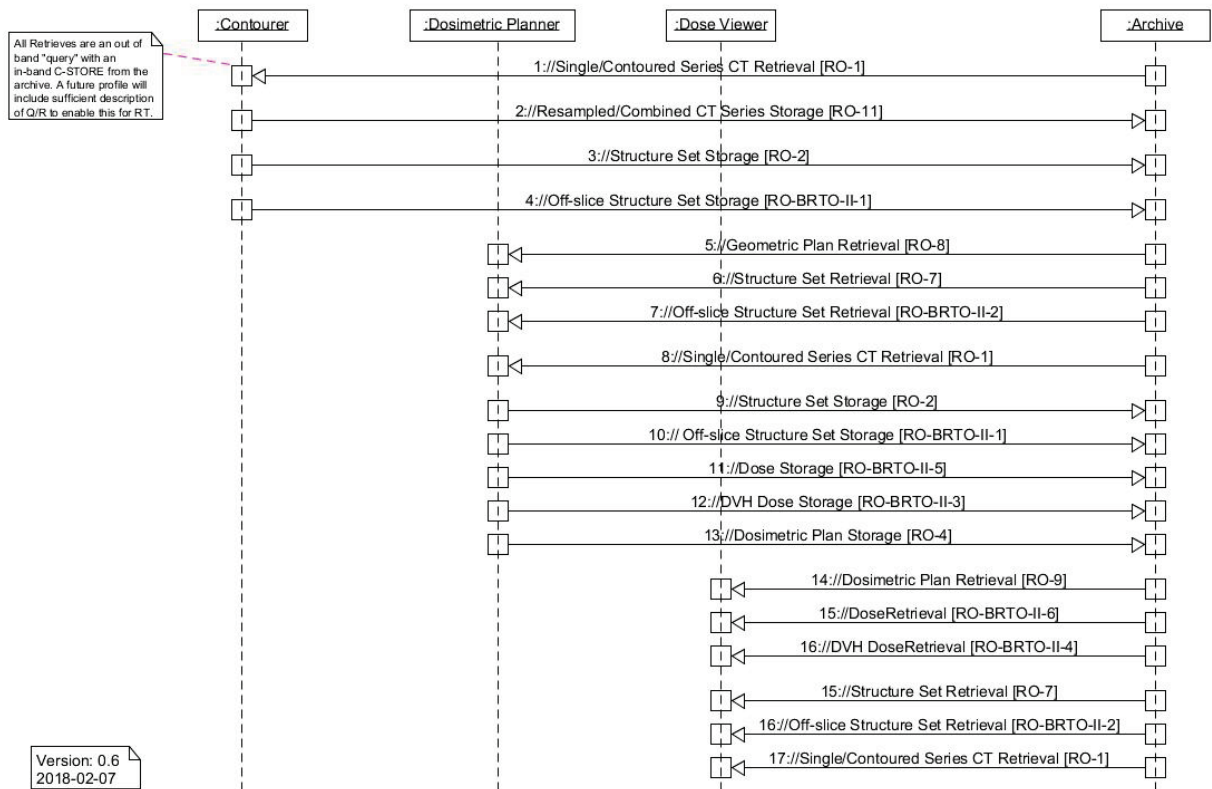

Figure 3.4.2-1: Basic Process Flow in Basic RT Objects Profile

3.4.2.1 Use Case #1: Segmentation of Treatment-Relevant Structures

375 At the beginning of the planning process for a Radiation Therapy, treatment-relevant structures have to be contoured based on an image data set. These structures shall be persisted in an RT Structure Set.

3.4.2.1.1 Segmentation of Treatment-Relevant Structures Use Case Description

380 The user wants to create a structure object containing the target volume(s) and organs at risk relevant for a treatment planning. These objects are contoured on an initial CT image set. When the contouring is finished the structure object will be persisted in an archive.

3.4.2.1.2 Segmentation of Treatment-Relevant Structures Process Flow

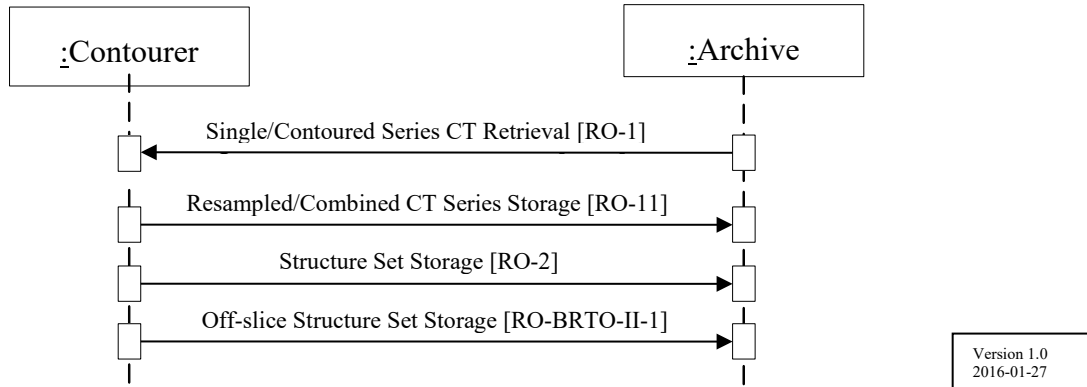

Figure 3.4.2.1.2-1: Segmentation of Treatment-Relevant Structures Process Flow in BRTO-II Profile

385

Pre-conditions:

The initial image set is available.

Main Flow:

The initial image set is retrieved by the contouring system, which sends the RT Structure Set back to the archiving system.

390

Post-conditions:

The RT Structure Set is archived.

3.4.2.2 Use Case #2: Treatment Planning Based on Segmented Objects

Based on the previously contoured structures a treatment planning is performed. As a result an RT Plan and an RT Dose object are persisted, representing the planning result.

395

3.4.2.2.1 Treatment Planning Based on Segmented Objects Use Case Description

The user wants to create a treatment plan for the patient based on previously contoured object definitions. These object definitions and referenced image sets are retrieved by the Treatment Planning System (TPS) acting as a Dosimetric Planner. The user creates an appropriate plan for treatment. The content of such a plan is beyond the scope of this profile. The resulting RT Plan and a corresponding dose distribution shall be saved back to an archive.

400

Optionally the Dose Volume Histogram (DVH) is saved back to the archive.

3.4.2.2.2 Treatment Planning Based on Segmented Objects Process Flow

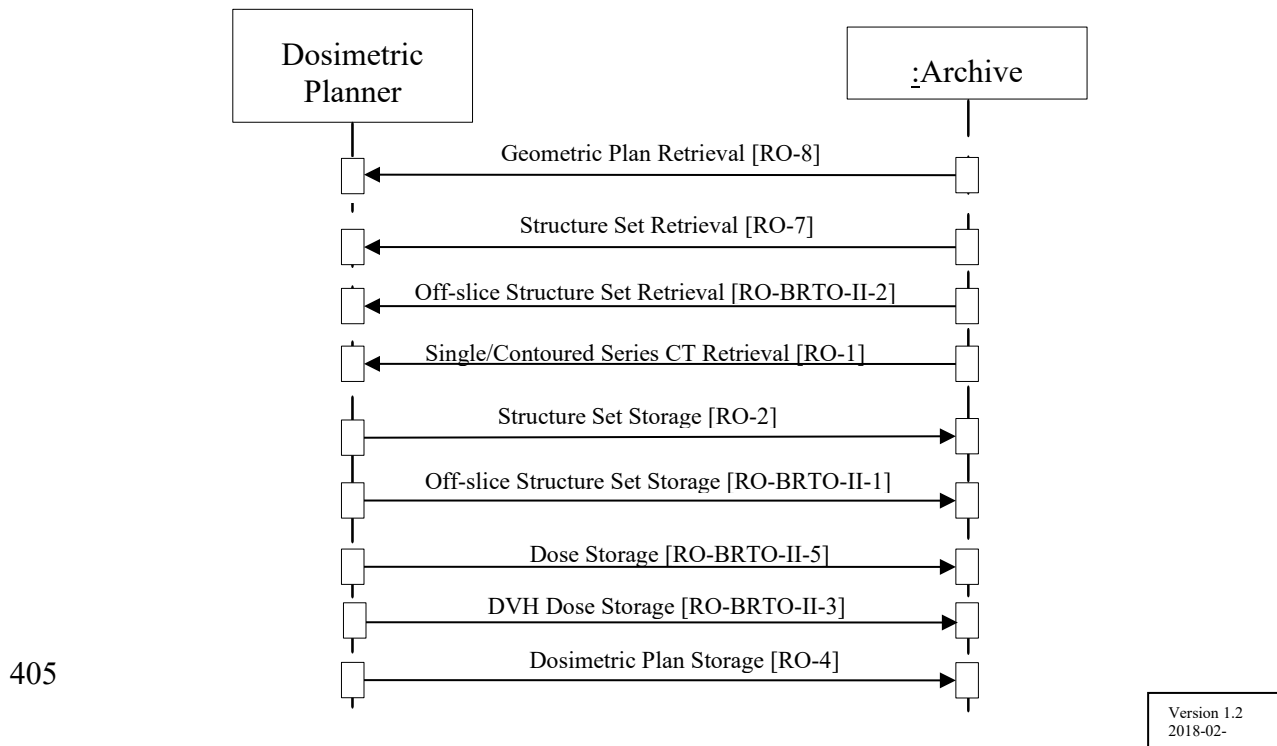

Figure 3.4.2.2.2-1: Treatment Planning Based on Segmented Objects Process Flow in BRTO-II Profile

Pre-conditions:

410 The initial image set and RT Structure Set are available.

Main Flow:

The initial image set(s) and RT Structure Set are retrieved by the Treatment Planning System (TPS). The user creates RT Plan on the TPS and calculates the dose. The TPS send the results sends back to the archiving system.

415 **Post-conditions:**

The RT Plan and RT Dose objects are archived.

3.4.2.3 Use Case #3: Dose Display of Treatment Planning Results

The result of previous treatment planning is shown to the user.

3.4.2.3.1 Dose Display of Treatment Planning Results Use Case Description

420 The user wants to inspect the result of previous treatment planning. The created object definitions including the dose distribution are retrieved by the Dose Displayer and shown to the user.

Optionally the Dose Volume Histogram (DVH) is imported and displayed.

3.4.2.3.2 Dose Display of Treatment Planning Results Process Flow

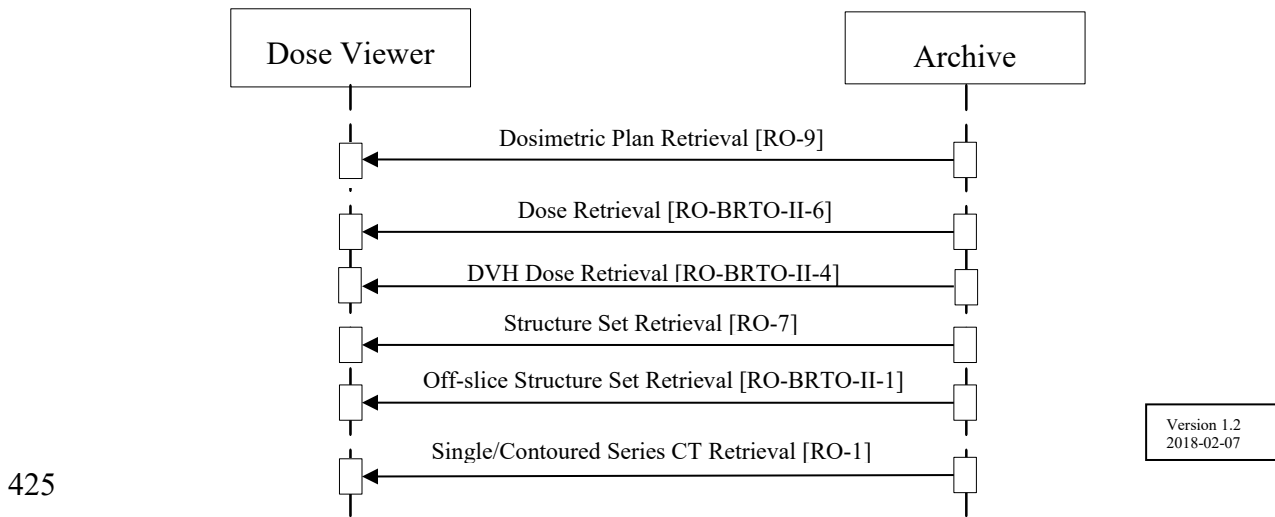

Figure 3.4.2.3.2-1: Dose Display of Treatment Planning Results Process Flow in BRTO-II Profile

Pre-conditions:

430 The planning CT image set, RT Structure Set, RT Plan and RT Dose are available.

Main Flow:

The planning CT image set, RT Structure Set, RT Plan and RT Dose are retrieved by the Dose Displayer, which shows the given information to the user.

Post-conditions:

435 None.

3.5 BRTO II Security Considerations

There are no explicit security considerations in this profile.

3.6 BRTO II Cross Profile Considerations

440 Segmentation requirements of this profile are expected to be referenced by other profiles.

4 Multimodality Image Registration for Radiation Oncology 2018 (MMRO-III) Profile

445 This Integration Profile specifies how images, RT Structure Sets, RT Doses, and associated spatial registration information can be exchanged, stored, processed and displayed. For a display workstation, it is essential that a workstation correctly identifies the corresponding image sets, matches data from single-slice and multi-slice datasets, matches coordinate systems, and performs spatial translations. The use of relevant DICOM objects (Spatial Registration) is clarified and constrained in order to avoid misinterpretation.

450 The Multimodality Image Registration for Radiation Oncology 2018 (MMRO-III) Profile focuses on content for image registration and does not define a registration workflow. Such workflow could be managed by using mechanisms described in the Post-Acquisition Workflow Integration Profile (see RAD TF-1: 12).

The MMRO-III Profile currently only handles rigid registration. Deformable registration will be addressed in a separate Profile in the future.

455 The MMRO-III Profile does not specify the use of quantification methods for the image data that are created or displayed. In particular, interoperability for PET Standard Uptake Values (SUV) is considered a relevant future work item for IHE. Note that vendors may wish to provide SUV capability even though not required under this Profile.

460 The MMRO-III Profile has implicit limitations imposed by its dependency on the IHE-RO BRTO-II Profile. The most significant of these are listed here:

- Only the following patient orientations {HFS, HFP, FFS, FFP} shall be considered to be within the scope of this profile. Actors participating in this profile may be capable of handling additional orientations (decubitus), but such orientations will not be tested with this profile.

465 The primary image set shall be of modality CT or MR. The image orientation of the “primary” shall be transversal. The “secondary” image set shall be a rectilinear, not skewed, not sheared image set of modality CT, MR or PET. Their image orientation shall be one of the cardinal planes +/-30°. Other image orientations are out of scope of this profile.

470 RT Dose shall be in the Registered Frame of Reference, e.g., in the same Frame of Reference as its referenced image set.

4.1 Actors / Transactions

475 Figure 4.1-1 shows the actors directly involved in the MMRO-III Profile and the relevant transactions between them. If needed for context, other actors that may be indirectly involved due to their participation in other related profiles are shown in dotted lines. Actors which have a mandatory grouping are shown in conjoined boxes.

This Profile uses the MMRO Registered Contourer Actor, which must be compatible with RT Structure Set objects created by the BRTO-II Profile Contourer Actor.

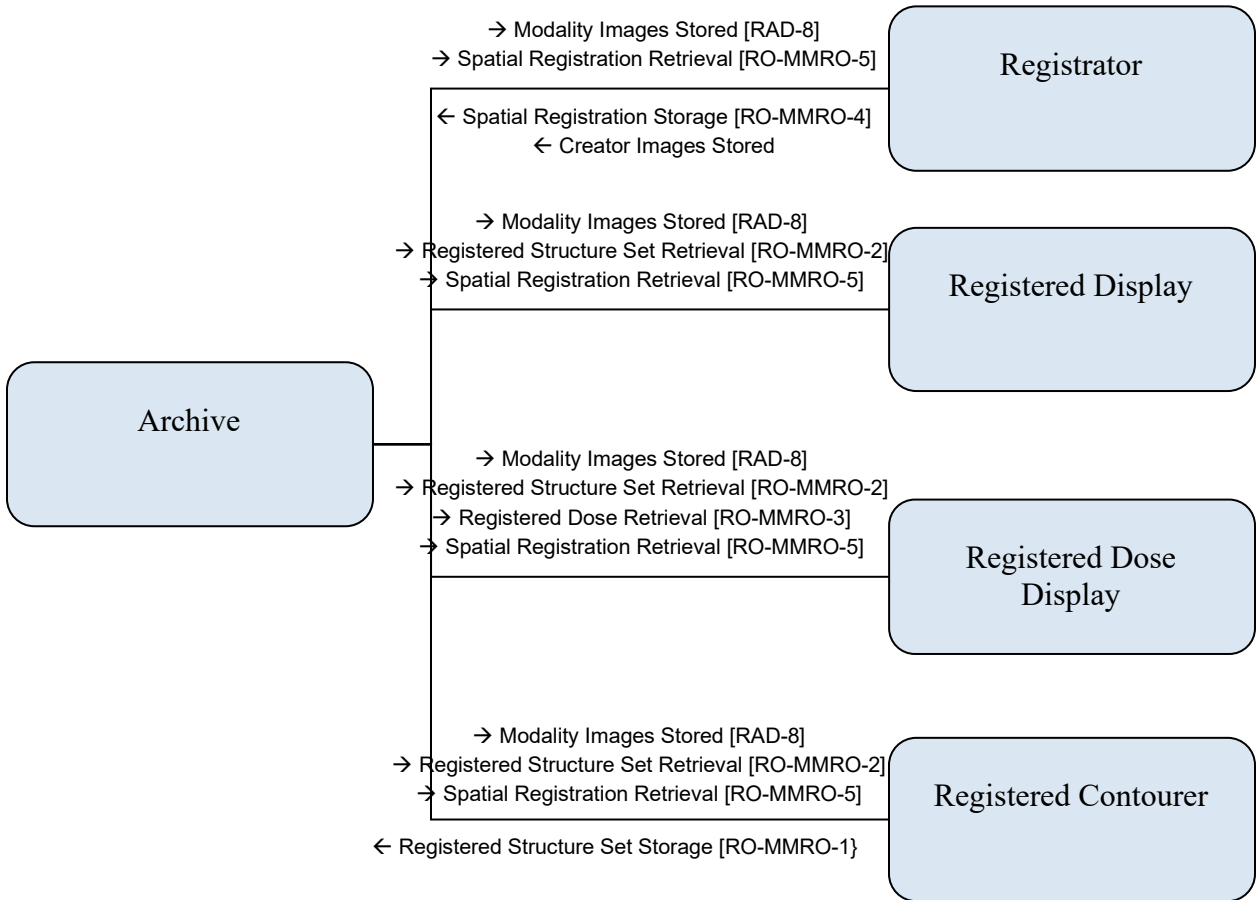

480

Figure 4.1-1: MMRO-III Actor Diagram

Table 4.1-1 lists the transactions for each actor directly involved in the MMRO-III Profile. In order to claim support of this Profile, an implementation of an actor must perform the required transactions (labeled “R”) and may support the optional transactions (labeled “O”). Actor groupings are further described in Section 4.3.

485

490

Table 4.1-1: MMRO-III Profile – Actors and Transactions

Actors	Transactions	Optionality	Section in Vol. 2
Archive	Modality Images Stored	R	RAD 4.8
	Creator Images Stored	R	RAD 4.18
	Registered Structure Set Storage	R	MMRO-3
	Spatial Registration-III Storage	R	MMRO-III-1
	Spatial Registration-III Retrieval	R	MMRO-III-2
	Registered Dose Retrieval	R	MMRO-5
	Registered Structure Set Retrieval	R	MMRO-4
Registrar	Modality Images Stored	R	RAD 4.8
	Creator Images Stored	O	RAD 4.18
	Spatial Registration-III Retrieval	O	MMRO-III-2
	Spatial Registration-III Storage	R	MMRO-III-1
Registered Contourer	Modality Images Stored	R	RAD 4.8
	Registered Structure Set Storage	R	MMRO-3
	Registered Structure Set Retrieval	R	MMRO-4
	Spatial Registration-III Retrieval	R	MMRO-III-2
Registered Display	Modality Images Stored	R	RAD 4.8
	Registered Structure Set Retrieval	R	MMRO-4
	Spatial Registration-III Retrieval	R	MMRO-III-2
Registered Dose Display	Modality Images Stored	R	RAD 4.8
	Registered Structure Set Retrieval	R	MMRO-4
	Registered Dose Retrieval	R	MMRO-5
	Spatial Registration-III Retrieval	R	MMRO-III-2

4.1.1 Actor Descriptions and Actor Profile Requirements

495 No special requirements

4.2 MMRO-III Actor Options

Options that may be selected for this Profile are listed in the Table 4.2-1 along with the actors to which they apply. Dependencies between options when applicable are specified in notes.

500

Table 4.2-1: MMRO-III - Actors and Options

Actor	Options	Volume & Section
Archive	<i>No options defined</i>	--
Registrator	Creator Images Stored	RAD 4.18
	Spatial Registration-III Retrieval	MMRO-III-2
Registered Contourer	<i>No options defined</i>	--
Registered Display	<i>No options defined</i>	--
Registered Dose Display	<i>No options defined</i>	--

4.3 MMRO-III Actor Required Groupings

None.

4.4 MMRO-III Overview

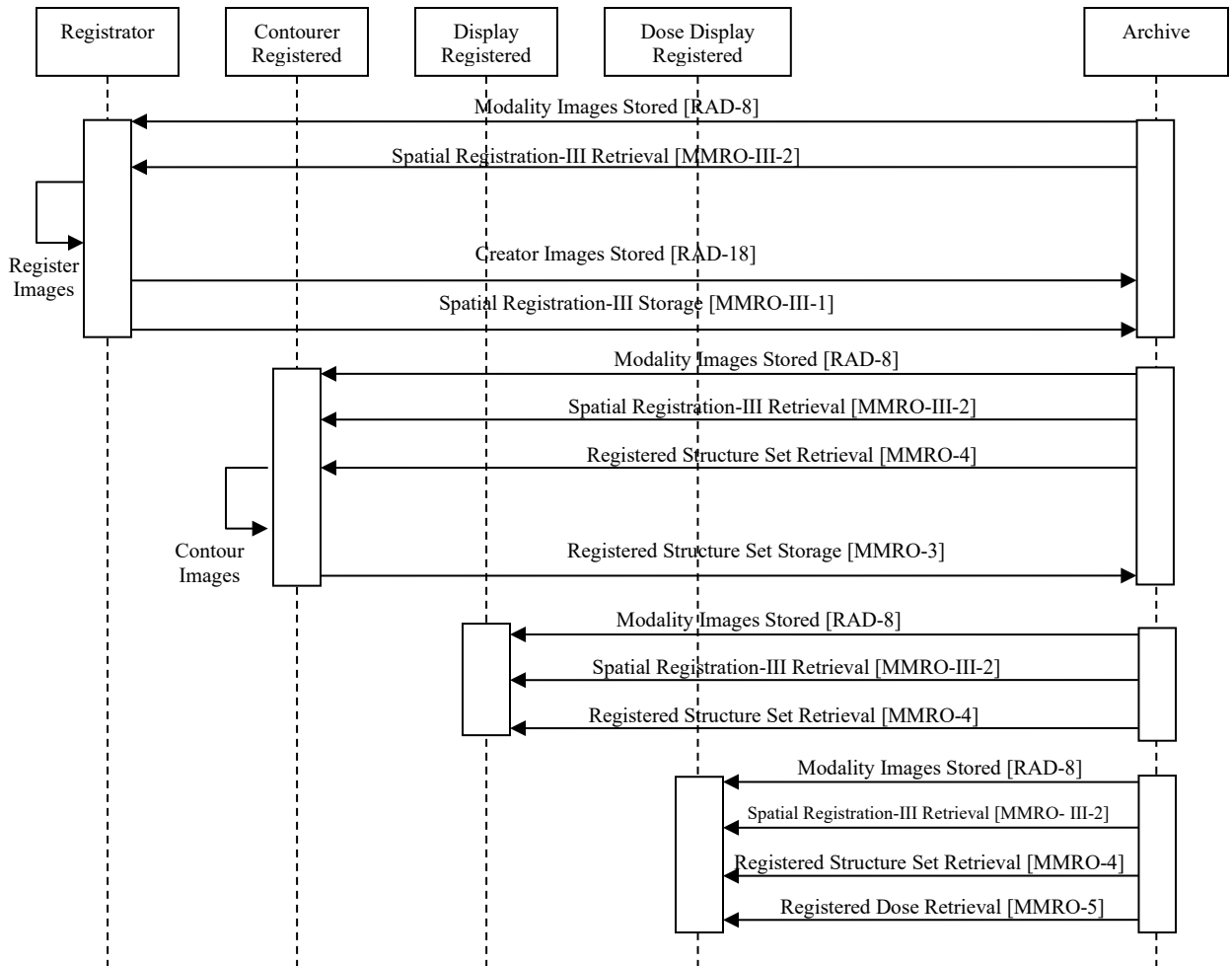

505

Figure 4.4-1: Overall Process Flow in MMRO Profile

4.4.1 Concepts

4.4.1.1 Creating Datasets

510 The MMRO-III Profile applies to many types of data. Although each type may need to be handled differently, fused display is possible with each type.

The image sets will usually be created by Acquisition Modality Actors, however in some scenarios the image sets could be the result of post-processing by a Registrator Actor.

This profile only addresses the registration of volumetric datasets, RT Structure Set and RT Dose objects.

515 Volumetric datasets refer to a collection of planar images which span a volume and each image has a defined location in space. Typical examples include a set of CT transverse slices, MR slice stacks and PET transaxial images. In the “easiest” situation, multiple volumetric datasets are created in the same Frame Of Reference. Datasets with the same Frame of Reference value are inherently registered and so a registration step is not strictly necessary.

520 A shared Frame of Reference may be the result of:

- A hybrid scanner such as a PET/CT being used to image the patient.
- A positioning system, such as a fixed head frame, being used to position the patient at the same location and orientation each time for imaging.
- A single scanner being used to image the patient at several closely spaced time intervals (e.g., gated cardiac or pulmonary imaging).
- A second image set being created by a post-processing step (e.g., tissue enhancement or tumor segmentation) and inheriting the Frame of Reference of the first image set.

525

Note that image sets with a shared Frame of Reference UID implies they are in the same reference coordinate system, but does not guarantee that they overlap. For example, a pelvis series and a head series from the same MR scan may share a Frame of Reference.

530

More typically, volumetric datasets are each created with a unique Frame Of Reference.

Different Frames of Reference may be the result of:

- Different equipment being used to image the patient
- The same piece of equipment being used to image the patient at different times
- Different patients/subjects being imaged (as in a comparative study or when patient images are mapped to an atlas for display or analysis)

535

4.4.1.2 Registering Datasets

To perform registration when datasets do not share a Frame of Reference, it is necessary to define a relationship between them. Even if two datasets do share a Frame of Reference, for example on the basis of assuming no patient motion, or assuming two acquisition systems are perfectly calibrated, it is sometimes still useful to perform a registration based on fiducials, image content or something else.

540

Once the registration is complete, the resulting transformation is recorded in a Spatial Registration object which is typically stored in the study with the image data. The DICOM Spatial Registration object supports rigid registrations (translation and rotation).. The “primary” image data set is the one that shares the same Frame of Reference as the Spatial Registration Object and shall have an identity transformation matrix. Spatial Registration objects will usually be created by Registrator Actors; however in some situations a registration object will not be strictly required (if the datasets share the same Frame of Reference).

545

550 There are many methods/algorithms for registration: matching fiducials that are visible in the
datasets, using operator input to help align the data, correlating the information content in the
datasets, etc. Specifying a method/algorithm to use to arrive at the transformation is outside the
scope of this profile. The specific method/algorithm used may be of interest to the user
(especially when several different registrations exist between the same datasets) so it is
555 recommended that the name and description of the method be recorded in the resulting Spatial
Registration Object.

If the application wishes to allow registration of more than 2 volumetric datasets it shall produce
multiple Spatial Registration objects. The first Spatial Registration Object shall establish the
Registered Frame of Reference for all of the Spatial Registration Objects. Subsequent objects
560 shall transform a single volumetric dataset into the Registered Frame of Reference.

In some cases, it is conceivable that an Registrator may combine existing registration
information without performing a registration process. For example if a registration exists to map
dataset A into Frame of Reference C and another registration exists to map dataset B into Frame
of Reference C, the Registrator could use those transforms to produce a new set of Spatial
565 Registration Objects for dataset A and B which transform into a Registered Frame of Reference.

When registering volumetric datasets, the mapping describes the spatial transformation between
Frames of Reference. Since the specific images exist in one of those Frames of Reference, they
can be mapped to each other.

This profile does not address registering datasets which share a common Frame of Reference. If
570 the application wishes to provide this functionality it should store one or both of the datasets with
a new Frame of Reference UID and allow the user to perform the registration with those datasets.
This avoids the need to define a non-unity transform from a Frame of Reference to itself. This
capability is not required to satisfy this profile.

Identifying and obtaining an appropriate matching pair of datasets to register is necessary but is
575 not defined by this profile. IHE ensures that some useful query parameters are available, but in
the end this task is left to the implementer.

4.4.1.3 Resampling Datasets

After a Spatial Registration has been applied, the data in the two datasets is in the same
coordinate system, but may still have different pixel resolution, pixel spacing, slice thickness,
580 number of slices, slice positions or even slice orientations. Before display is possible, it is
necessary to resample the registered dataset into the Registered Frame of Reference. Also, the
Image Orientation and Patient Position of the resampled dataset shall match that of the Base
dataset.

Note that when resampling values, such as NM and PET counts, that are not normalized to the
585 volume represented by the pixel, the resampled pixel value may be quite different from the
original pixel value. For example, when creating a new image with twice the number of pixels in
the X and Y directions, 1 pixel in the original data is now 4 pixels in the resampled data, and the
value of each of the new pixels would be expected to be roughly $\frac{1}{4}$ of the value of the original
pixel. When resampling values that are not directly linked to the area/volume of the pixel (such

590 as Hounsfield units), the new pixels will have values similar to the original pixel (partial volume effects notwithstanding).

The exact values produced by resampling also depends on the interpolation algorithm used. The specification of such algorithms is outside the scope of this profile.

595 In the Radiotherapy domain there will also be instances of RT Structure Set and RT Dose objects which exist in the same Frame of Reference as one of the datasets being registered. The structures described as contours in the RT Structure Sets will be subject to resampling prior to display. The resampling of the contours depends on the resampling algorithm used and is outside the scope of this profile.

Resampling of RT Dose objects is not supported within this profile.

600 The Registered Display Actor is required to be able to perform any resampling needed for the display. Some Modalities or Registrators may choose to generate resampled datasets. The advantage is that such datasets might be useful to non-registration aware display stations, and even when provided to IHE Registered Display Actors, might conceivably provide improved display performance. In most cases, however, storing the resampled data will significantly
605 increase bandwidth and storage costs. This capability is not required to satisfy this profile.

Note that the stepping interval when scrolling through slices may be of primary importance to users and care should be taken in that respect. Sometimes the user may wish to step in increments of the original slices of the underlying set, and sometimes in the increments of the original slice or pixel spacing of the superimposed data set.

610 **4.4.1.4 Presenting Registered Datasets**

Presentation of the Registered Datasets is performed by the Registered Display Actor.

No DICOM Query transaction for Spatial Registration objects exists currently. For the purpose of this profile it will be assumed that the registered images and the required Spatial Registration objects will be made available to the Registered Display Actor. The data will be transferred via
615 C-STORE operations, but the initiation of the action is out of band for this profile.

The Registered Display transforms the datasets by applying the spatial registrations according to the DICOM specification, and resamples the datasets as necessary for display.

620 Simple registered display could involve presentation of a single frame at a time. For some clinical interpretation tasks, presentation of a registered MPR (Multi Planar Reconstructed) view is considered essential. Many users will also expect to be able to change the transparency of the fusion overlay (blending factor), the color map for the overlay, the Window Width/Level for each data set, and other display parameters. For PET data, controls for upper & lower Window Level are valuable.

4.4.1.5 Spatial Registrations and Frame of Reference

625 This profile requires the Spatial Registration object not only to contain the Frame of References that are registered, but also registered instances (e.g., images). This is required for safety when registering two frames of references without further capability of verification. As an example, there are scanners that acquire two sequential image series, both with the same Frame of

630 Reference. If the patient moves between image acquisitions, there will exist two image series with the same Frame of Reference, but spatially inconsistent image information.

Applications are required to warn users if they receive Spatial Registration objects without image references. Similarly, warnings should occur if the displayed image sets include images not explicitly listed in the Spatial Registration objects.

4.4.1.6 Well-known Frame of Reference

635 This profile defines the content and usage of Registrations between image series. Registering image series to a Well-known Frame of Reference is possible, but out of scope of this profile.

Note that when registering multiple image series to a Well-known FOR, ambiguities may occur due to the transitive nature.

4.4.2 Use Cases

640 4.4.2.1 Use Case #1: Multimodality Contouring

Two or more series of images, for example, CT, MR and PET, are acquired and stored to an archive system. The images, potentially with different Frames of Reference, are read in, registered, and then used for identifying volumes of interest (VOI) which are stored using an RT Structure Set object.

645 4.4.2.1.1 Multimodality Contouring Use Case Description

- Two or more series of images, for example a CT, MR and PET series, are acquired and reconstructed on multiple different Acquisition Modalities.
 - The image sets, each with a different Frame of Reference, are stored to the Archive.
 - Contrary to prior definitions of this profile, the actors defined here do not require establishing a Registered Frame of Reference which is the Frame of Reference of a CT image series. For example: to describe the registration of all 3 image sets, 2 Spatial Registration objects will be required. The first may register the CT to the MR, and the second may register the PET to the MR. A Registrator shall be able to accept any combination of Spatial Registration objects and may then internally re-organize the registrations. Any registrations created by a Registrator shall reflect the registrations that were actually performed by the user.
 - A Registered Contourer Actor receives the image sets and Spatial Registrations and creates an RT Structure Set in the same Frame of Reference as one of the datasets. If the image sets are a superset of the images listed in the Spatial Registration IOD, the application shall warn the user of the use of potentially non-registered images. Each dataset may have a RT Structure Set created in its Frame of Reference.
650
655 Note that in case structures are resampled from one image set to another, it is currently not possible to indicate where the structures originated.
 - The Registered Contourer will store the RT Structure Set(s) to the Archive.
- 660

- 665 • To render the display, the Registered Display uses the transformation in the Spatial Registration to translate the superimposed data into the same space as the underlying image data. Since each RT Structure Set shares a Frame of Reference UID with one of the datasets, the structures can be transformed by resampling using the same transformation for the volume of interest as defined for the underlying image set.
- 670 • The appearance of the fused display is out of band for this profile.

4.4.2.1.2 Multimodality Contouring Process Flow

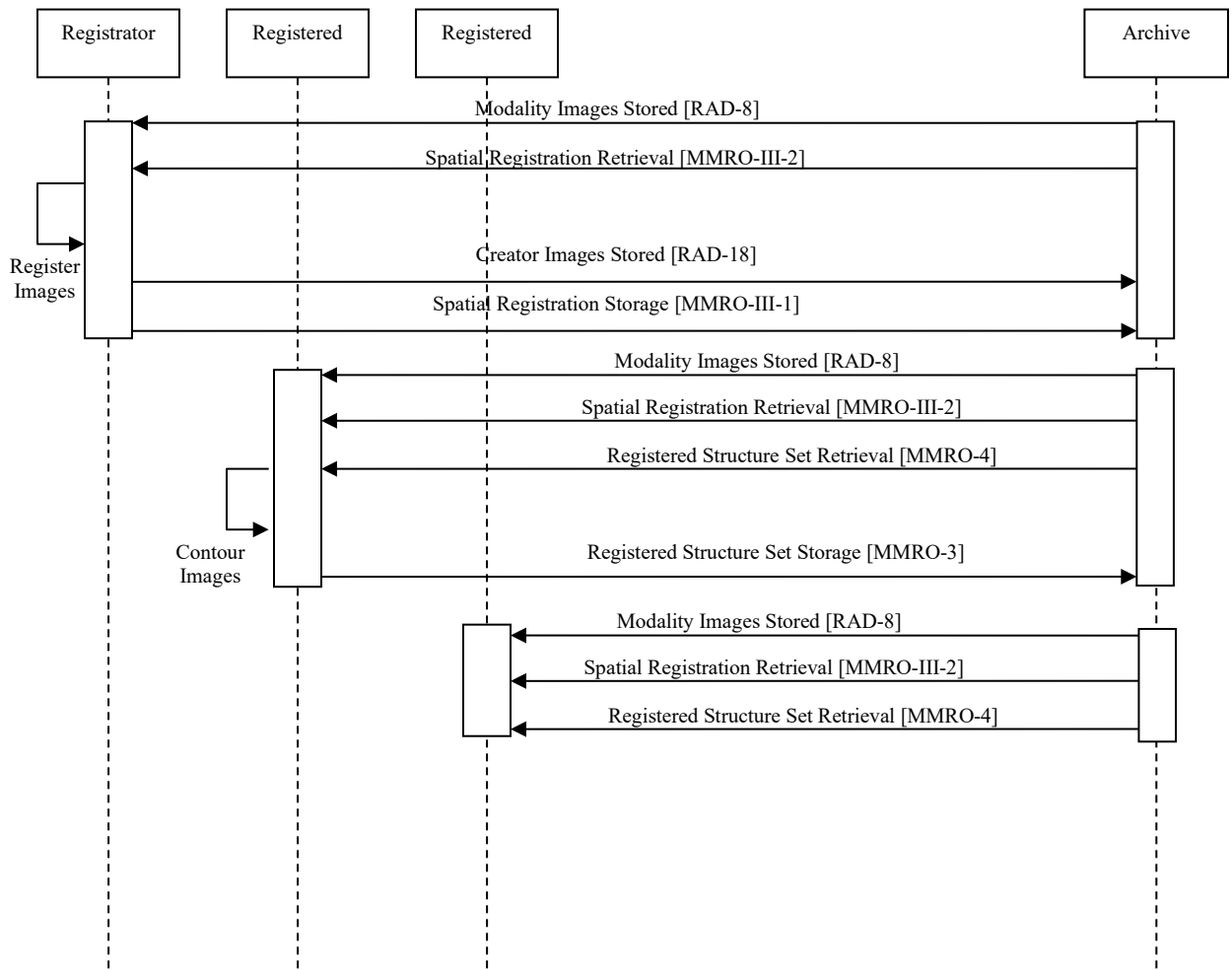

Figure 4.4.2.1.2-1: Process Flow for Multimodality Contouring Use Case

4.4.2.2 Use Case #2: Shared Frame of Reference

- 675 Hybrid Modalities, (e.g., PET/CT Scanner) combine two modalities into a single system. Typically they calibrate the couch motion and scan space and, assuming the patient does not move, store two image sets mapped into a common space (described by a single Frame of

Reference). This also applies to RT objects, such as RT Structure Set and RT Dose objects, as they will share a common Frame of Reference with an image set.

680 **4.4.2.2.1 Shared Frame of Reference Use Case Description**

- Two series of images, for example a PET series and a CT series, are acquired and reconstructed on a single hybrid system.
- The image sets, each with the same Frame of Reference, are stored to the Archive. A common Frame of Reference implies that the two image sets are already in the same coordinate system and no transformation is required.
- A Registered Contourer Actor retrieves the image sets and creates RT Structure Sets in the same Frame of Reference as the image sets. Each RT Structure Set shall reference only a single image set. If structures are defined for both image sets, two RT Structure Set instances will be created.
- The Registered Contourer will store the RT Structure Set(s) to the Archive.
- However, if the patient moves between scans, the shared Frame of Reference does not correctly identify that related pixel information of the separate image datasets are in the same spatial location. Verification and /or an additional registration step is recommended to verify/ensure the correct relation. See also 4.5.1.2 and 4.5.1.5.
- A Registered Display is sent the image sets and RT Structure Set(s), and observes that no Spatial Registration object is referenced. It also observes that the two image sets and the RT Structure Set share the same Frame of Reference.
- The Registered Display re-samples the image sets, if necessary to match resolutions for display. No spatial registration transformation is required.
- The appearance of the fused display is out of band for this profile.

4.4.2.2.2 Shared Frame of Reference Process Flow

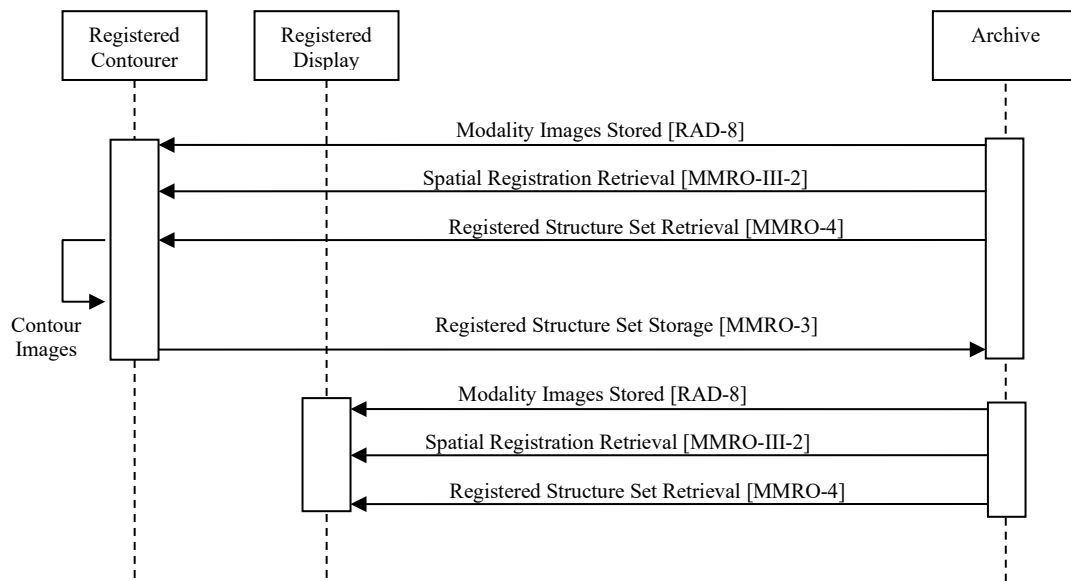

Figure 4.4.2.2-1: Process Flow for Shared Frame of Reference Use Case

4.4.2.3 Use Case #3: Multimodality Dose Display

705 Two or more series of images, for example, CT, MR and PET, are acquired and stored to an archive system. The images, potentially with different Frames of Reference, are read in, registered, and then used for identifying volumes of interest (VOI) which are stored using an RT Structure Set object. An RT Dose object is created (out of band) utilizing the information and stored in the Frame of Reference of one of the image sets.

710 4.4.2.3.1 Multimodality Dose Display Use Case Description

- Two or more series of images, for example a CT, MR and PET series, are acquired and reconstructed on multiple different Acquisition Modalities.
- The image sets, each with a different Frame of Reference, are stored to the Archive.
- A treatment plan is created from the image sets, along with RT Structure Sets, an RT Dosimetric Plan, and an RT Dose object.
- 715 • A Registered Dose Display is sent the image sets, RT Structure Set(s) and RT Dose along with the required Spatial Registrations.
- The Registered Dose Display re-samples the image sets, RT Structure Sets, and RT Dose as needed for appropriate display.
- 720 • The appearance of the fused display is out of band for this profile.

4.4.2.3.2 Multimodality Dose Display Process Flow

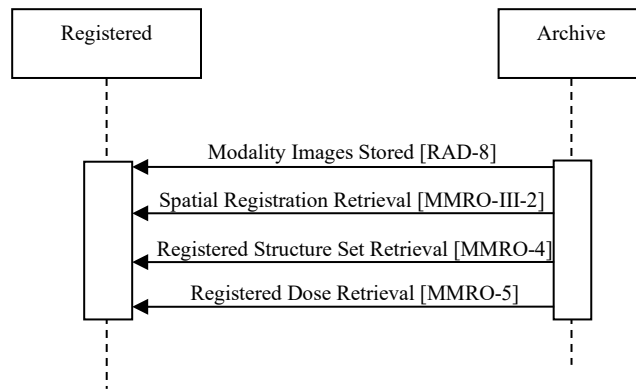

Figure 4.4.2.3.2-1: Process Flow for Multimodality Dose Display Use Case

4.5 MMRO-III Security Considerations

725 No specific considerations.

4.6 MMRO-III Cross Profile Considerations

No specific considerations.

730 **5 Treatment Planning – Plan Content Integration (TPPC) Profile**

This integration profile involves the exchange of RT Plan information between treatment planning systems and between treatment planning systems and treatment management systems. The emphasis for this profile is on reducing ambiguity involved in re-planning and incorporation of the planning information into the treatment management system in anticipation of transfer to a treatment delivery system. The transactions revolve around content rather than workflow.

735

This profile addresses a broad variety of “Beam Techniques” that exist in Radiation Therapy. Rather than define actors that had broad involvement in many optional transactions, a large number of actors were defined which have specific mandatory/required transactions and a small number of optional transactions related to beam modifiers. The actors are either producers or consumers of a DICOM RT Plan.

740

5.1 Actors / Transactions

Figure 5.1-1 shows the actors directly involved in the TPPC Profile and the relevant transactions between them. If needed for context, other actors that may be indirectly involved due to their participation in other related profiles are shown in dotted lines. Actors which have a mandatory grouping are shown in conjoined boxes.

745

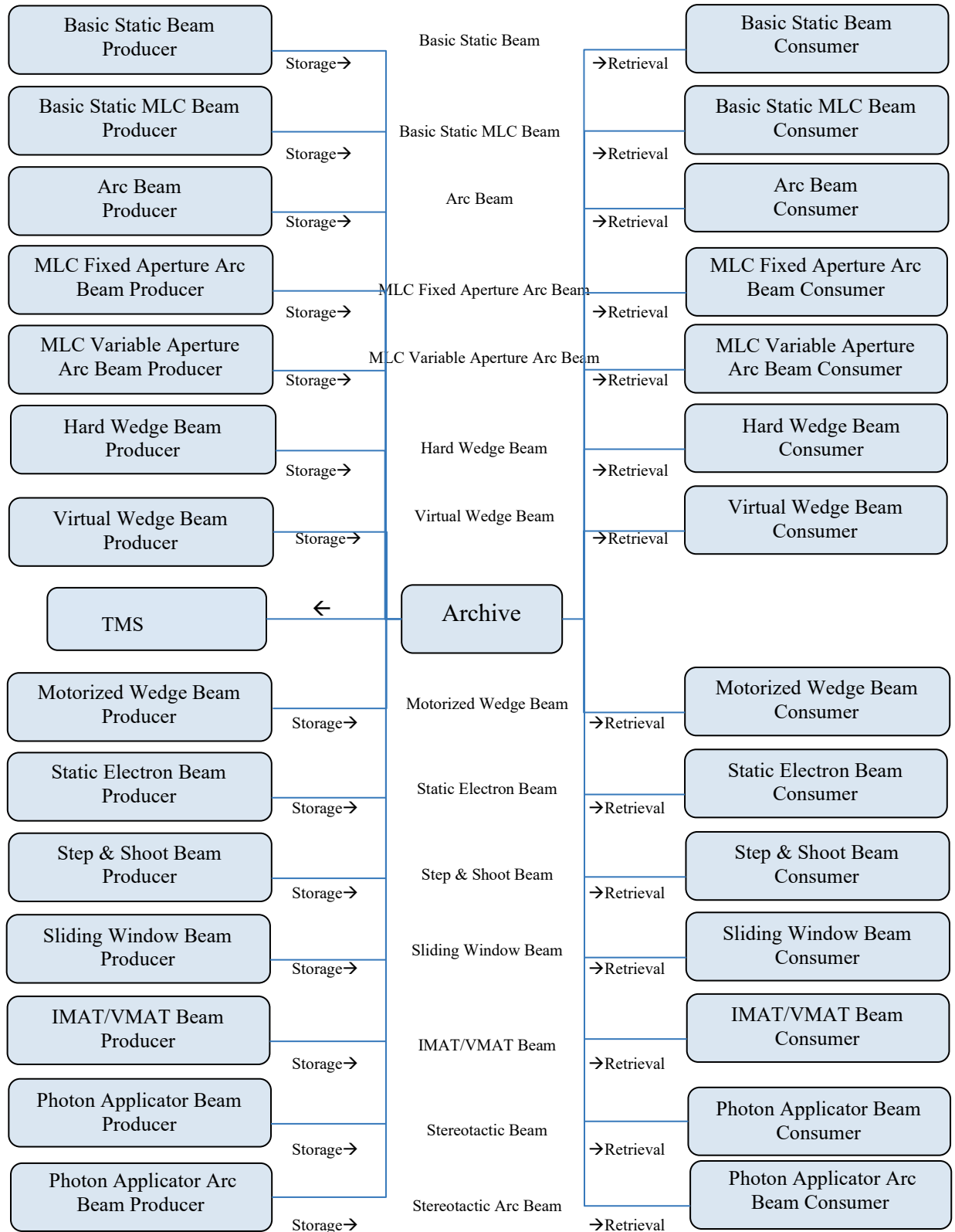

Figure 5.1-1: TPPC Actor Diagram

750

Table 5.1-1 lists the transactions for each actor directly involved in the TPPC Profile. In order to claim support of this Profile, an implementation of an actor must perform the required transactions (labeled “R”) and may support the optional transactions (labeled “O”). Actor groupings are further described in Section 5.3.

Table 5.1-1: TPPC Profile - Actors and Transactions

Actors	Transactions	Optionality	Section in Vol. 2
Archive	Basic Static Beam Storage	R	TPPC-01
	Basic Static Beam Retrieval	R	TPPC-02
	Basic Static MLC Beam Storage	R	TPPC-03
	Basic Static MLC Beam Retrieval	R	TPPC-04
	Arc Beam Storage	R	TPPC-05
	Arc Beam Retrieval	R	TPPC-06
	MLC Fixed Aperture Arc Beam Storage	R	TPPC-07
	MLC Fixed Aperture Arc Beam Retrieval	R	TPPC-08
	MLC Variable Aperture Arc Beam Storage	R	TPPC-09
	MLC Variable Aperture Arc Beam Retrieval	R	TPPC-10
	Hard Wedge Beam Storage	R	TPPC-11
	Hard Wedge Beam Retrieval	R	TPPC-12
	Virtual Wedge Beam Storage	R	TPPC-13
	Virtual Wedge Beam Retrieval	R	TPPC-14
	Motorized Wedge Beam Storage	R	TPPC-15
	Motorized Wedge Beam Retrieval	R	TPPC-16
	Static Electron Beam Storage	R	TPPC-17
	Static Electron Beam Retrieval	R	TPPC-18
	Step & Shoot Beam Storage	R	TPPC-19
	Step & Shoot Beam Retrieval	R	TPPC-20
	Sliding Window Beam Storage	R	TPPC-21
	Sliding Window Beam Retrieval	R	TPPC-22
	IMAT/VMAT Beam Storage	R	TPPC-23
	IMAT/VMAT Beam Retrieval	R	TPPC-24
	Photon Applicator Beam Storage	R	TPPC-25
	Photon Applicator Beam Retrieval	R	TPPC-26
	Photon Applicator Arc Beam Storage	R	TPPC-27
	Photon Applicator Arc Beam Retrieval	R	TPPC-28
Treatment Management System (TMS)	Basic Static Beam Retrieval	O	TPPC-02
	Basic Static MLC Beam Retrieval	O	TPPC-04

Actors	Transactions	Optionality	Section in Vol. 2
(See Note Below)	Arc Beam Retrieval	O	TPPC-06
	MLC Fixed Aperture Arc Beam Retrieval	O	TPPC-08
	MLC Variable Aperture Arc Beam Retrieval	O	TPPC-10
	Hard Wedge Beam Retrieval	O	TPPC-12
	Virtual Wedge Beam Retrieval	O	TPPC-14
	Motorized Wedge Beam Retrieval	O	TPPC-16
	Static Electron Beam Retrieval	O	TPPC-18
	Step & Shoot Beam Retrieval	O	TPPC-20
	Sliding Window Beam Retrieval	O	TPPC-22
	IMAT/VMAT Beam Retrieval	O	TPPC-24
	Photon Applicator Beam Retrieval	O	TPPC-26
	Photon Applicator Arc Beam Retrieval	O	TPPC-26
Basic Static Beam Producer	Basic Static Beam Storage	R	TPPC-01
Basic Static Beam Consumer	Basic Static Beam Retrieval	R	TPPC-02
Basic Static MLC Beam Producer	Basic Static MLC Beam Storage	R	TPPC-03
Basic Static MLC Beam Consumer	Basic Static MLC Beam Retrieval	R	TPPC-04
Arc Beam Producer	Arc Beam Storage	R	TPPC-05
Arc Beam Consumer	Arc Beam Retrieval	R	TPPC-06
MLC Fixed Aperture Arc Beam Producer	MLC Fixed Aperture Arc Beam Storage	R	TPPC-07
MLC Fixed Aperture Arc Beam Consumer	MLC Fixed Aperture Arc Beam Retrieval	R	TPPC-08
MLC Variable Aperture Arc Beam Producer	MLC Variable Aperture Arc Beam Storage	R	TPPC-09
MLC Variable Aperture Arc Beam Consumer	MLC Variable Aperture Arc Beam Retrieval	R	TPPC-10
Hard Wedge Beam Producer	Hard Wedge Beam Storage	R	TPPC-11
Hard Wedge Beam Consumer	Hard Wedge Beam Retrieval	R	TPPC-12
Virtual Wedge Beam Producer	Virtual Wedge Beam Storage	R	TPPC-13
Virtual Wedge Beam Consumer	Virtual Wedge Beam Retrieval	R	TPPC-14
Motorized Wedge Beam Producer	Motorized Wedge Beam Storage	R	TPPC-15
Motorized Wedge Beam Consumer	Motorized Wedge Beam Retrieval	R	TPPC-16
Static Electron Beam Producer	Static Electron Beam Storage	R	TPPC-17
Static Electron Beam Consumer	Static Electron Beam Retrieval	R	TPPC-18
Step & Shoot Beam Producer	Step & Shoot Beam Storage	R	TPPC-19
Step & Shoot Beam Consumer	Step & Shoot Beam Retrieval	R	TPPC-20
Sliding Window Beam Producer	Sliding Window Beam Storage	R	TPPC-21
Sliding Window Beam Consumer	Sliding Window Beam Retrieval	R	TPPC-22
IMAT/VMAT Beam Producer	IMAT/VMAT Beam Storage	R	TPPC-23

Actors	Transactions	Optionality	Section in Vol. 2
IMAT/VMAT Beam Consumer	IMAT/VMAT Beam Retrieval	R	TPPC-24
Photon Applicator Beam Producer	Stereotactic Beam Storage	R	TPPC-25
Photon Applicator Beam Consumer	Stereotactic Beam Retrieval	R	TPPC-26
Photon Applicator Arc Beam Producer	Stereotactic Arc Beam Storage	R	TPPC-27
Photon Applicator Arc Beam Consumer	Stereotactic Arc Beam Retrieval	R	TPPC-28

755 Note: The TMS Integration Statement will indicate which transactions it is capable of supporting. In general, these will be grouped according to the overall functionality of the TMS Actor. For example, a general TMS would likely support all 14 transactions, while a Radiosurgery TMS may only support the Stereotactic-oriented beams. In addition, for cases where there are insufficient actors for complete testing of the TMS, the TMS can pass the Connectathon by claiming those transactions it successfully completed.

760 5.1.1 Actor Descriptions and Actor Profile Requirements

Normative requirements are typically documented in Volume 2 (Transactions) and Volume 3 (Content Modules). Some Integration Profiles, however, contain requirements which link transactions, data, and/or behavior. Those Profile requirements are documented in this section as normative requirements (“shall”).

765 5.2 TPPC Transaction Options

Options that may be selected for this profile are listed in the Table 5.2-1 along with the transactions to which they apply. In Table 5.1-1, each * Beam Producer has exactly one transaction, * Beam Storage. Similarly, each * Beam Consumer has exactly one transaction, * Beam Retrieval. For each of these, there are additional content options as noted in Table 5.2-1 from the set of {Bolus, Block, Compensator, Hard Wedge}. One or more of these content additions can be added to the base transaction based on the Integration Statement for the application. The Archive Actor must implement all options of all transactions. The TMS Actor must implement all options of all Retrieval transactions. Dependencies between options when applicable are specified in notes.

775

Table 5.2-1: TPPC - Transaction Options

Transactions	Options	Optionality	Section in Vol 2
Basic Static Beam Storage	Bolus Beam Modifier	O	3.19
	Block Beam Modifier	O	3.19
	Compensator Beam Modifier	O	3.19
Basic Static Beam Retrieval	Bolus Beam Modifier	O	3.20
	Block Beam Modifier	O	3.20
	Compensator Beam Modifier	O	3.20
Basic Static MLC Beam Storage	Bolus Beam Modifier	O	3.21
	Compensator Beam Modifier	O	3.21
Basic Static MLC Beam Retrieval	Bolus Beam Modifier	O	3.22
	Compensator Beam Modifier	O	3.22
Arc Beam Storage	Bolus Beam Modifier	O	3.23
	Block Beam Modifier	O	3.23
Arc Beam Retrieval	Bolus Beam Modifier	O	3.24
	Block Beam Modifier	O	3.24
MLC Fixed Aperture Arc Beam Storage	Bolus Beam Modifier	O	3.25
MLC Fixed Aperture Arc Beam Retrieval	Bolus Beam Modifier	O	3.26
MLC Variable Aperture Arc Beam Storage	Bolus Beam Modifier	O	3.27
	Block Beam Modifier	O	3.27
MLC Variable Aperture Arc Beam Retrieval	Bolus Beam Modifier	O	3.28
	Block Beam Modifier	O	3.28
Hard Wedge Beam Storage	Bolus Beam Modifier	O	3.29
	Block Beam Modifier	O	3.29
	Compensator Beam Modifier	O	3.29
Hard Wedge Beam Retrieval	Bolus Beam Modifier	O	3.30
	Block Beam Modifier	O	3.30
	Compensator Beam Modifier	O	3.30
Virtual Wedge Beam Storage	Bolus Beam Modifier	O	3.31
	Block Beam Modifier	O	3.31
	Compensator Beam Modifier	O	3.31
	Hard Wedge Beam Modifier	O	3.31
Virtual Wedge Beam Retrieval	Bolus Beam Modifier	O	3.32
	Block Beam Modifier	O	3.32
	Compensator Beam Modifier	O	3.32
	Hard Wedge Beam Modifier	O	3.32
Motorized Wedge Beam Storage	Bolus Beam Modifier	O	3.33
	Block Beam Modifier	O	3.33
	Compensator Beam Modifier	O	3.33
	Hard Wedge Beam Modifier	O	3.33

Transactions	Options	Optionality	Section in Vol 2
Motorized Wedge Beam Retrieval	Bolus Beam Modifier	O	3.34
	Block Beam Modifier	O	3.34
	Compensator Beam Modifier	O	3.34
	Hard Wedge Beam Modifier	O	3.34
Static Electron Beam Storage	Bolus Beam Modifier	O	3.35
	Block Beam Modifier	O	3.35
	Compensator Beam Modifier	O	3.35
Static Electron Beam Retrieval	Bolus Beam Modifier	O	3.36
	Block Beam Modifier	O	3.36
	Compensator Beam Modifier	O	3.36
Step & Shoot Beam Storage	Bolus Beam Modifier	O	3.37
	Block Beam Modifier	O	3.37
	Compensator Beam Modifier	O	3.37
	Hard Wedge Beam Modifier	O	3.37
Step & Shoot Beam Retrieval	Bolus Beam Modifier	O	3.38
	Block Beam Modifier	O	3.38
	Compensator Beam Modifier	O	3.38
	Hard Wedge Beam Modifier	O	3.38
Sliding Window Beam Storage	Bolus Beam Modifier	O	3.39
	Block Beam Modifier	O	3.39
	Compensator Beam Modifier	O	3.39
	Hard Wedge Beam Modifier	O	3.39
Sliding Window Beam Retrieval	Bolus Beam Modifier	O	3.40
	Block Beam Modifier	O	3.40
	Compensator Beam Modifier	O	3.40
	Hard Wedge Beam Modifier	O	3.40
IMAT/VMAT Beam Storage	Bolus Beam Modifier	O	3.41
IMAT/VMAT Beam Retrieval	Bolus Beam Modifier	O	3.42
Photon Applicator Beam Storage	Bolus Beam Modifier	O	3.43
Photon Applicator Beam Retrieval	Bolus Beam Modifier	O	3.44
Photon Applicator Arc Beam Storage	Bolus Beam Modifier	O	3.45
Photon Applicator Arc Beam Retrieval	Bolus Beam Modifier	O	3.46

5.2.1 Producer / Consumer Transaction Groupings

780 Although not within the scope of this profile, it is possible for a clinical application to produce a
treatment plan using several beams, each of which is defined by a different **Beam Storage**
transaction as defined in this profile. For Producers, it is clinically acceptable for them to create a
treatment plan with beams satisfying any of the Producer transactions with which they claim
adherence. For such cases, a Consumer Actor which also claims adherence to **Beam Retrieval**
785 transactions encompassing the composited treatment plan may be able to receive such a plan
containing a mixed transaction set of beams. However, if the Consumer Actor cannot accept a
plan with such a mixed set of beams, it must be able to handle the rejection of the plan in a safe
manner.

790 Although an application may claim adherence to a set of transactions involving one or more
Producer / Consumer pairs, the plan produced may not be deliverable by the equipment defined
in a specific SOP instance created by a transaction. It is not required that all transactions defined
in this profile are capable of being delivered by all delivery devices. As a result, there may be
single transaction plans, or mixed transaction plans, that are not capable of being delivered by a
795 given delivery device, even though it is defined as the delivery device in the treatment plan. The
application user must be aware of the limitations of their delivery equipment, and should
configure, where possible, their treatment planning systems and treatment management systems
so that such incompatible plans cannot be created. Where such configuration is not possible, the
application user should be aware of the limitations, and recognize that such plans may fail to be
800 accepted when transferred to the delivery equipment, which is responsible for handling such
incompatible plans in a safe manner.

5.3 TPPC Actor Required Groupings

None.

5.4 TPPC Overview

805 This integration profile involves the exchange of RT Plan information between treatment
planning systems and between treatment planning systems and treatment management systems.
The emphasis for this profile is on reducing ambiguity involved in re-planning and incorporation
of the planning information into the treatment management system in anticipation of transfer to a
treatment delivery system.

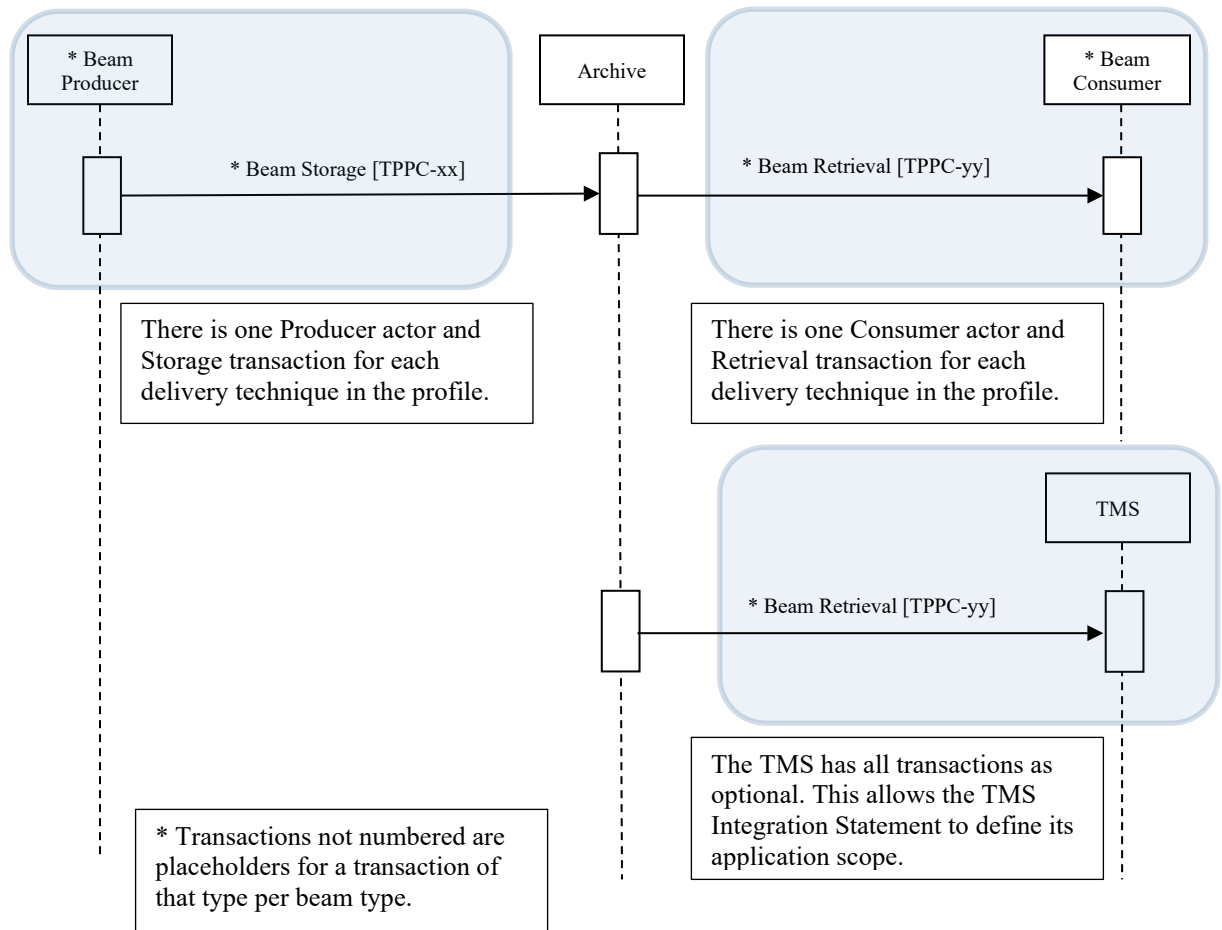

810

Figure 5.4.1-1: Overall Process Flow in TPPC Profile

5.4.1 Concepts

815 This profile addresses a broad variety of “Beam Techniques” that exist in Radiation Therapy. Rather than define actors that have broad involvement in many optional transactions, a large number of actors were defined which each have specific mandatory/required transactions and a small number of optional transactions related to beam modifiers. The actors are either producers or consumers of a DICOM RT Plan.

820 It is expected that the actual products commonly referred to as Treatment Planning Systems will implement one or more of the “producer” actors, and that the choice of which actors are implemented (for which adherence is claimed) will depend on the intended functionality (which is not defined by IHE-RO). A Treatment Planning System that is intended to be able to perform re-planning based on the output of another Treatment Planning System would be expected to adhere to one or more of the “consumer” actors.

825 It is expected that the actual products variously referred to as Oncology Information Systems, Oncology Information Management, or Electronic Medical Record for Oncology will implement

the Treatment Management System (TMS) Actor. While the profile does not dictate the functionality of the TMS, the TMS is responsible for providing an adequate view of the information provided to it (as a Beam Consumer) such that, in normal operating practice, the appropriate user can ensure that the planning information has been properly consumed, associated with the correct patient, etc. No transactions have been defined between the TMS Actor in this profile and the TMS Actor in other profiles, and any necessary interface is considered private (in the same way that an Image Manager and an Image Archive are related in the Radiology Domain Scheduled Workflow Profile). In practice, it is expected that once a TMS has consumed the information provided to it by a Beam Producer, the system incorporating the TMS Actor will then be able to act as the TMS in delivery-oriented profiles and provide that information to a Treatment Delivery System Actor in that profile. It is not expected that a TMS Actor for this profile from one vendor will interoperate with a TMS Actor for other delivery profiles from another vendor. As indicated in the table identifying actors and transactions, the TMS Actor can support retrieval of any of the beam types (all transactions are optional). The TMS shall indicate in its Integration Statement the scope of its capabilities (i.e., which beam types it supports). It is expected that a TMS will support most, if not all, beam types. However, there may be beam types for which full testing is not possible due to limitations on the number of producers of a specific beam type, hence the optional transaction list.

830

835

840

845 It should also be noted that chapter 7 in this Supplement's Volume 3 specifies content that is mandatory across all transactions.

Finally, there are individual attributes within a RT Plan that are not specified in this profile, but have significant safety implications if ignored. As much as possible, these attributes have been identified in the transactions and it is indicated that a 'retrieval' actor shall handle RT Plans that may include these attributes in a safe manner. This behavior can include rejection of the RT Plan or appropriate warnings (with user acknowledgement) as possible courses of action in such circumstances.

850

5.4.2 Use Cases

855 5.4.2.1 Use Case #1: Treatment Replanning

A radiation oncology treatment planning system (TPS) creates and stores a treatment plan according to one of the techniques specified. A second TPS, requiring the initial plan in order to add/change information, retrieves the original treatment plan, modifies the plan, and then stores the modified treatment plan as a new plan to the archive.

860 5.4.2.1.1 Treatment Re-planning Use Case Description

- A TPS, through transactions not described in this profile (but similar to the IHE-RO Basic Radiation Therapy Objects Profile) acquires sufficient information to create a treatment plan according to one of the treatment techniques described in this profile.
- The treatment plan is stored to the archive.
- 865 • A second TPS, required the original treatment plan in order to modify it, will read in the original plan, perform modifications to the plan, and then save the modified plan as a new plan to the archive.

5.4.2.1.2 Treatment Re-planning Process Flow

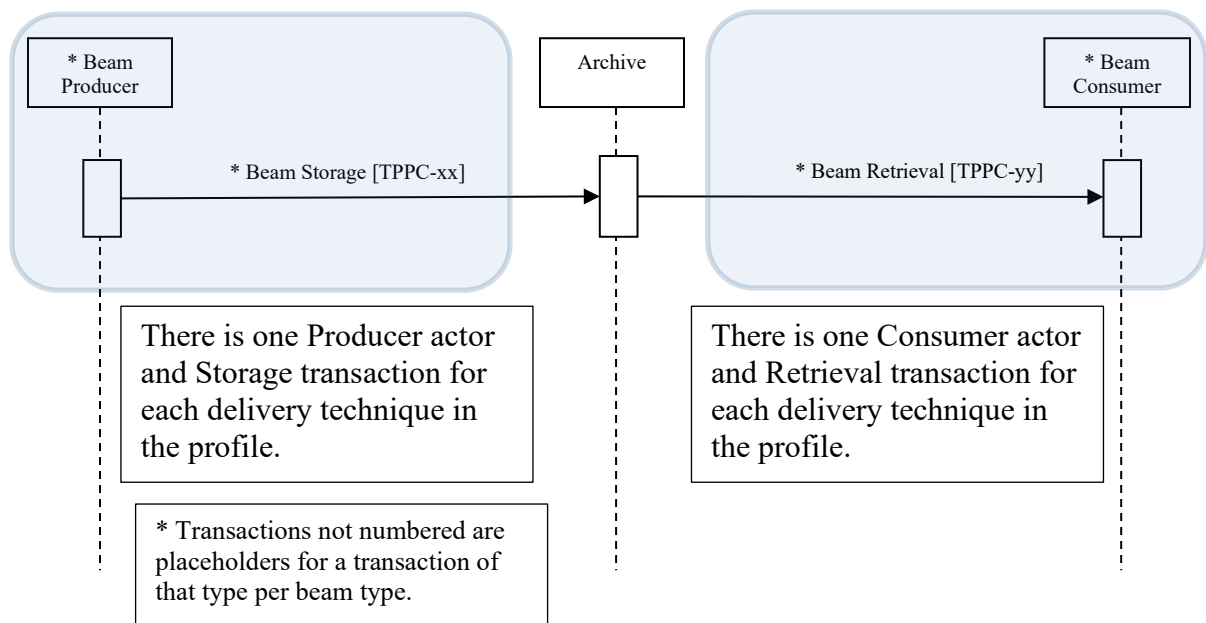

870 **Figure 5.4.2.1.2-1: Process Flow for Treatment Re-planning Use Case**

5.4.2.2 Use Case #2: TMS Upload

875 A radiation oncology treatment planning system (TPS) creates and stores a treatment plan according to one of the techniques specified. The Treatment Management System (TMS) retrieves the treatment plan in order to process it for further use and potential delivery (not included in this profile).

5.4.2.2.1 TMS Upload Use Case Description

- A TPS, through transactions not described in this profile (but similar to the IHE-RO Basic Radiation Therapy Objects Profile) acquires sufficient information to create a treatment plan according to one of the treatment techniques described in this profile.

880

- The treatment plan is stored to the archive.
- A TMS retrieves the plan from the archive.

5.4.2.2.2 TMS Upload Process Flow

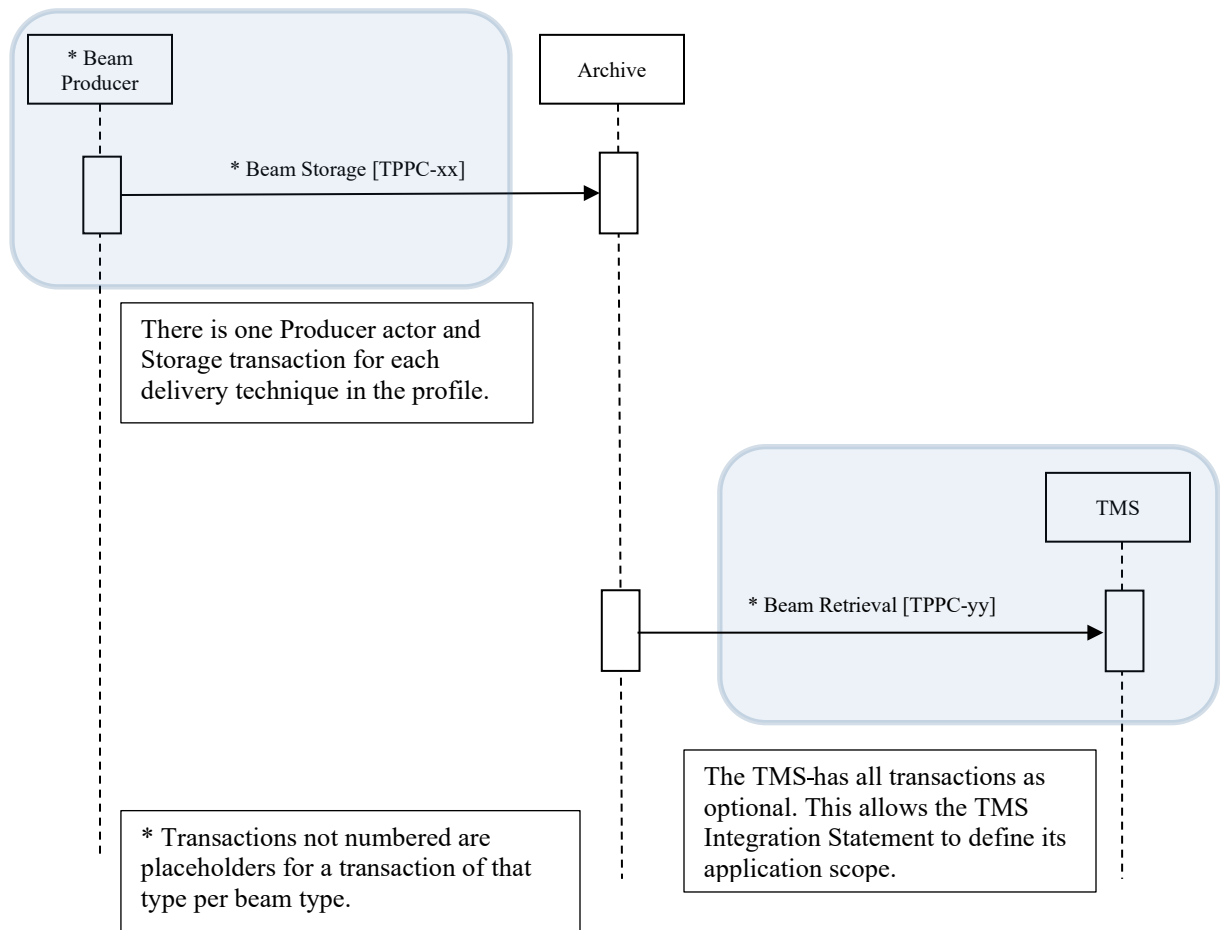

885

Figure 5.4.2.2.2-1: Process Flow for TMS Upload Use Case

5.5 TPPC Security Considerations

Not Applicable

5.6 TPPC Cross Profile Considerations

Not applicable

890

895

Appendices

Appendix A – Actor Descriptions

Actors are information systems or components of information systems that produce, manage, or act on information associated with operational activities in the enterprise. The following are definitions of actors used in the IHE Radiation Oncology Integration Profiles:

900 **Acquisition Modality** – A system that acquires and creates medical images while a patient is present, e.g., a Computed Tomography scanner or Nuclear Medicine camera. A modality may also create other evidence objects such as Grayscale Softcopy Presentation States for the consistent viewing of images or Evidence Documents containing measurements.

905 **Archive** – A system that provides long term storage of evidence objects such as images, presentation states, Key Image Notes and Evidence Documents.

Contourer – A system that consumes one or more CT image series and creates an RT Structure Set. If the Contourer consumes multiple CT image series or has an internal requirement for resampling, it also will generate a single CT image series to which the RT Structure Set maps. A Contourer shall be able to consume CT image series with non-uniform spacing.

910 **Dosimetric Planner** – A system that consumes a single CT image series, an RT Structure Set, and a Geometric Plan and creates a Dosimetric Plan and an RT Dose.

Archive (including RT) – A system that stores the RT SOP Classes in addition to the CT images and is capable of transmitting them.

915 **Dose Displayer** – A system that consumes a Dosimetric Plan, a single CT image series, an RT Structure Set, and an RT Dose and displays the dose.

Registrar – A system that consumes multi-modality images and generates 1 or more Spatial Registration objects.

920 **Registered Contourer** – A system that consumes multi-modality images, RT Structure Set objects, and Spatial Registration objects and allows the user to contour images in a **Registered Display**.

Registered Display – A system that consumes multi-modality images, RT Structure Set objects, and Spatial Registration objects and allows the user to display the registered information.

925 **Registered Dose Display** – A system that consumes multi-modality images, RT Structure Set objects, RT Dose objects and Spatial Registration objects and allows the user to display the registered information.

Basic Static Beam Producer – A Treatment Planning System (TPS) capable of producing a radiation therapy treatment plan with static, non-MLC, treatment beams.

Basic Static Beam Consumer – A Treatment Planning System (TPS) capable of consuming a radiation therapy treatment plan with static, non-MLC, treatment beams.

- 930 **Basic Static MLC Beam Producer** – A Treatment Planning System (TPS) capable of producing a radiation therapy treatment plan with static, MLC, treatment beams.
- Basic Static MLC Beam Consumer** – A Treatment Planning System (TPS) capable of consuming a radiation therapy treatment plan with static, MLC, treatment beams.
- 935 **Arc Beam Producer** – A Treatment Planning System (TPS) capable of producing a radiation therapy treatment plan with non-MLC Fixed Aperture Arc treatment beams.
- Arc Beam Consumer** – A Treatment Planning System (TPS) capable of consuming a radiation therapy treatment plan with non-MLC Fixed Aperture Arc treatment beams.
- MLC Fixed Aperture Arc Beam Producer** – A Treatment Planning System (TPS) capable of producing a radiation therapy treatment plan with MLC Fixed Aperture Arc treatment beams.
- 940 **MLC Fixed Aperture Arc Beam Consumer** – A Treatment Planning System (TPS) capable of consuming a radiation therapy treatment plan with MLC Fixed Aperture Arc treatment beams.
- MLC Variable Aperture Arc Beam Producer** – A Treatment Planning System (TPS) capable of producing a radiation therapy treatment plan with MLC Variable Aperture Arc treatment beams.
- 945 **MLC Variable Aperture Arc Beam Consumer** – A Treatment Planning System (TPS) capable of consuming a radiation therapy treatment plan with MLC Variable Aperture Arc treatment beams.
- Hard Wedge Beam Producer** – A Treatment Planning System (TPS) capable of producing a radiation therapy treatment plan with static treatment beams using physical wedges.
- 950 **Hard Wedge Beam Consumer** – A Treatment Planning System (TPS) capable of consuming a radiation therapy treatment plan with static treatment beams using physical wedges.
- Virtual Wedge Beam Producer** – A Treatment Planning System (TPS) capable of producing a radiation therapy treatment plan with static treatment beams using virtual wedges.
- Virtual Wedge Beam Consumer** – A Treatment Planning System (TPS) capable of consuming a radiation therapy treatment plan with static treatment beams using virtual wedges.
- 955 **Motorized Wedge Beam Producer** – A Treatment Planning System (TPS) capable of producing a radiation therapy treatment plan with static treatment beams using motorized wedges.
- Motorized Wedge Beam Consumer** – A Treatment Planning System (TPS) capable of consuming a radiation therapy treatment plan with static treatment beams using motorized wedges.
- 960 **Static Electron Beam Producer** – A Treatment Planning System (TPS) capable of producing a radiation therapy treatment plan with static electron treatment beams.
- Static Electron Beam Consumer** – A Treatment Planning System (TPS) capable of consuming a radiation therapy treatment plan with static electron treatment beams.
- 965 **Step & Shoot Beam Producer** – A Treatment Planning System (TPS) capable of producing a radiation therapy treatment plan with step & shoot IMRT treatment beams.

Step & Shoot Beam Consumer – A Treatment Planning System (TPS) capable of consuming a radiation therapy treatment plan with step & shoot IMRT treatment beams.

970 **Sliding Window Beam Producer** – A Treatment Planning System (TPS) capable of producing a radiation therapy treatment plan with sliding window IMRT treatment beams.

Sliding Window Beam Consumer – A Treatment Planning System (TPS) capable of consuming a radiation therapy treatment plan with sliding window IMRT treatment beams.

IMAT/VMAT Beam Producer – A Treatment Planning System (TPS) capable of producing a radiation therapy treatment plan with VMAT/IMAT IMRT treatment beams.

975 **IMAT/VMAT Beam Consumer** – A Treatment Planning System (TPS) capable of consuming a radiation therapy treatment plan with VMAT/IMAT IMRT treatment beams.

Photon Applicator Beam Producer – A Treatment Planning System (TPS) capable of producing a radiation therapy treatment plan with static, stereotactic treatment beams.

980 **Photon Applicator Beam Consumer** – A Treatment Planning System (TPS) capable of consuming a radiation therapy treatment plan with static, stereotactic treatment beams.

Photon Applicator Arc Beam Producer – A Treatment Planning System (TPS) capable of producing a radiation therapy treatment plan with stereotactic arc treatment beams.

Photon Applicator Arc Beam Consumer – A Treatment Planning System (TPS) capable of consuming a radiation therapy treatment plan with stereotactic arc treatment beams.

985 **Treatment Management System (TMS)** – An application providing radiation oncology management services and capable of consuming treatment plans with any of the above treatment techniques.

The following table shows which actors are used in which Integration Profiles.

Table A-1: Integration Profile Actors

Integration Profile Actor	BRTO-II	MMRO-III	TPPC
Acquisition Modality	X		
Archive	X		
Contourer	X		
Dosimetric Planner	X		
Dose Displayer	X		
Registrar		X	
Registered Contourer		X	
Registered Display		X	
Registered Dose Display		X	
Basic Static Beam Producer			X
Basic Static Beam Consumer			X
Basic Static MLC Beam Producer			X
Basic Static MLC Beam Consumer			X
Arc Beam Producer			X

Integration Profile Actor	BRTO-II	MMRO-III	TPPC
Arc Beam Consumer			X
MLC Fixed Aperture Arc Beam Producer			X
MLC Fixed Aperture Arc Beam Consumer			X
MLC Variable Aperture Arc Beam Producer			X
MLC Variable Aperture Arc Beam Consumer			X
Hard Wedge Beam Producer			X
Hard Wedge Beam Consumer			X
Virtual Wedge Beam Producer			X
Virtual Wedge Beam Consumer			X
Motorized Wedge Beam Producer			X
Motorized Wedge Beam Consumer			X
Static Electron Beam Producer			X
Static Electron Beam Consumer			X
Step & Shoot Beam Producer			X
Step & Shoot Beam Consumer			X
Sliding Window Beam Producer			X
Sliding Window Beam Consumer			X
IMAT/VMAT Beam Producer			X
IMAT/VMAT Beam Consumer			X
Photon Applicator Beam Producer			X
Photon Applicator Beam Consumer			X
Photon Applicator Arc Beam Producer			X
Photon Applicator Arc Beam Consumer			X
Treatment Management System (TMS)			X

990

Appendix B – Transactions

Transactions are interactions between actors that transfer the required information through standards-based messages. The following are brief descriptions of the transactions defined by IHE Radiation Oncology.

- 995
1. **Single/Contoured Image Series Retrieval [RO-1]:** The *Archive* stores a series of CT images to the *Contourer*, *Geometric Planner*, *Dosimetric Planner*, or *Dose Displayer*.
 2. **Structure Set Storage [RO-2]:** The *Contourer* stores an RT Structure Set to the *Archive*. The RT Structure Set shall reference only a single CT image series.
- 1000
3. **Geometric Plan Storage [RO-3]:** The *Geometric Planner* stores a newly created Geometric Plan to the *Archive*.
 4. **Dosimetric Plan Storage [RO-4]:** The *Dosimetric Planner* stores a Dosimetric Plan containing references to the RT Structure Set to the *Archive*. A Dosimetric Plan, as defined in the BRTO-II Profile, is not meant to be consumed by another *Dosimetric Planner* or a Treatment Management System.
- 1005
5. **Dose Storage [RO-5]:** The *Dosimetric Planner* stores a newly created RT Dose to the *Archive*.
 6. **Multi-Series Image Retrieval [RO-6]:** The *Archive* stores CT images from multiple series (but a single study) to a *Contourer* to make these images available for contouring.
- 1010
7. **Structure Set Retrieval [RO-7]:** The *Archive* stores an RT Structure Set on a *Contourer*, *Geometric Planner*, *Dosimetric Planner*, or *Dose Displayer*.
 8. **Dosimetric Plan Retrieval [RO-9]:** The *Archive* stores a Dosimetric Plan containing the references to the RT Structure Set to the *Dose Displayer*.
 9. **Dose Retrieval [RO-10]:** The *Archive* stores an RT Dose to the *Dose Displayer*.
- 1015
10. **Resampled/Combined CT Series Storage [RO-11]:** The *Contourer* stores CT images which have been combined or resampled into a single series to the *Archive*.
 11. **Registered Structure Set Storage [RO-14]:** In the Registered Structure Set Storage Transaction, the *Registered Contourer* stores a Structure Set on an *Archive* to make it available.
- 1020
12. **Registered Structure Set Retrieval [RO-15]:** In the Registered Structure Set Retrieval Transaction, the *Archive* stores a Structure Set to a *Registered Contourer*, *Registered Display* or *Registered Dose Display*.
 13. **Registered Dose Retrieval [RO-16]:** In the Registered Dose Retrieval Transaction, the *Archive* stores the requested RT Dose to the *Registered Dose Display* Actor.
- 1025
14. **Spatial Registration Storage [RO-12]:** In the Spatial Registration Storage transaction, the *Registrar* stores one or more Spatial Registration instances to the *Archive*. Spatial registration objects define how the pixel coordinates of one image data set are transformed to another coordinate system (for example to a coordinate system defined by another image data set thus allowing each dataset to be spatially aligned). A list of the

- 1030 images used in each Frame of Reference to determine the spatial registration shall be stored in the Spatial Registration instance.
- 1035 15. **Spatial Registration Retrieval:** A *Registered Display*, *Registered Dose Display* or *Registered Contourer* receives from an *Archive* one or more Spatial Registration objects carrying the transformation information to be applied to two image data sets intended for further processing or registered display. Each application receiving a Spatial Registration instance shall compare the image set to be used / displayed to the list of images for each Frame of Reference and warn the user if additional images are to be displayed for which the spatial registration may not be defined.
- 1040 16. **TPPC-01: Basic Static Beam Storage:** In the Basic Static Beam Storage transaction, a *Static Beam Producer* stores a treatment plan to the *Archive*. The treatment plan shall contain only static, non-MLC treatment beams.
- 1045 17. **TPPC-02: Basic Static Beam Retrieval:** In the Basic Static Beam Retrieval transaction, a *Static Beam Consumer* or a *TMS* receives a treatment plan from the *Archive*. The treatment plan shall contain only static, non-MLC treatment beams.
- 1050 18. **TPPC-03: Basic Static MLC Beam Storage:** In the Basic Static MLC Beam Storage transaction, a *Static MLC Beam Producer* stores a treatment plan to the *Archive*. The treatment plan shall contain only static, MLC treatment beams.
- 1055 19. **TPPC-04: Basic Static MLC Beam Retrieval:** In the Basic Static MLC Beam Retrieval transaction, a *Static MLC Beam Consumer* or a *TMS* receives a treatment plan from the *Archive*. The treatment plan shall contain only static, MLC treatment beams.
- 1060 20. **TPPC-05: Arc Beam Storage:** In the Arc Beam Storage transaction, an *Arc Beam Producer* stores a treatment plan to the *Archive*. The treatment plan shall contain only non-MLC Fixed Aperture Arc treatment beams.
- 1065 21. **TPPC-06: Arc Beam Retrieval:** In the Arc Beam Retrieval transaction, an *Arc Beam Consumer* or a *TMS* receives a treatment plan from the *Archive*. The treatment plan shall contain only non-MLC Fixed Aperture Arc treatment beams.
- 1060 22. **TPPC-07: MLC Fixed Aperture Arc Beam Storage:** In the MLC Fixed Aperture Arc Beam Storage transaction, an *MLC Fixed Aperture Arc Beam Producer* stores a treatment plan to the *Archive*. The treatment plan shall contain only MLC Fixed Aperture Arc treatment beams.
- 1065 23. **TPPC-08: MLC Fixed Aperture Arc Beam Retrieval:** In the MLC Fixed Aperture Arc Beam Retrieval transaction, an *MLC Fixed Aperture Arc Beam Consumer* or a *TMS* receives a treatment plan from the *Archive*. The treatment plan shall contain only MLC Fixed Aperture Arc treatment beams.
- 1065 24. **TPPC-09: MLC Variable Aperture Arc Beam Storage:** In the MLC Variable Aperture Arc Beam Storage transaction, a *MLC Variable Aperture Arc Beam Producer* stores a treatment plan to the *Archive*. The treatment plan shall contain only MLC Variable Aperture Arc treatment beams.

- 1070 25. **TPPC-10: MLC Variable Aperture Arc Beam Retrieval:** In the MLC Variable Aperture Arc Beam Retrieval transaction, an *MLC Variable Aperture Arc Beam Consumer* or a *TMS* receives a treatment plan from the *Archive*. The treatment plan shall contain only MLC Variable Aperture Arc treatment beams.
- 1075 26. **TPPC-11: Hard Wedge Beam Storage:** In the Hard Wedge Beam Storage transaction, a *Hard Wedge Beam Producer* stores a treatment plan to the *Archive*. The treatment plan shall contain only static treatment beams using physical wedges.
- 1080 27. **TPPC-12: Hard Wedge Beam Retrieval:** In the Hard Wedge Beam Retrieval transaction, a *Hard Wedge Beam Consumer* or a *TMS* receives a treatment plan from the *Archive*. The treatment plan shall contain only static treatment beams using physical wedges.
- 1085 28. **TPPC-13: Virtual Wedge Beam Storage:** In the Virtual Wedge Beam Storage transaction, a *Virtual Wedge Beam Producer* stores a treatment plan to the *Archive*. The treatment plan shall contain only static treatment beams using virtual wedges.
- 1090 29. **TPPC-14: Virtual Wedge Beam Retrieval:** In the Virtual Wedge Beam Retrieval transaction, a *Virtual Wedge Beam Consumer* or a *TMS* receives a treatment plan from the *Archive*. The treatment plan shall contain only static treatment beams using virtual wedges.
- 1095 30. **TPPC-15: Motorized Wedge Beam Storage:** In the Motorized Wedge Beam Storage transaction, a *Motorized Wedge Beam Producer* stores a treatment plan to the *Archive*. The treatment plan shall contain only static treatment beams using motorized wedges.
- 1100 31. **TPPC-16: Motorized Wedge Beam Retrieval:** In the Motorized Wedge Beam Retrieval transaction, a *Motorized Wedge Beam Consumer* or a *TMS* receives a treatment plan from the *Archive*. The treatment plan shall contain only static treatment beams using motorized wedges.
- 1105 32. **TPPC-17: Static Electron Beam Storage:** In the Static Electron Beam Storage transaction, a *Static Electron Beam Producer* stores a treatment plan to the *Archive*. The treatment plan shall contain only static electron treatment beams.
- 1110 33. **TPPC-18: Static Electron Beam Retrieval:** In the Static Electron Beam Retrieval transaction, a *Static Electron Beam Consumer* or a *TMS* receives a treatment plan from the *Archive*. The treatment plan shall contain only static electron treatment beams.
- 1115 34. **TPPC-19: Step & Shoot Beam Storage:** In the Step & Shoot Beam Storage transaction, a *Step & Shoot Beam Producer* stores a treatment plan to the *Archive*. The treatment plan shall contain only step & shoot IMRT treatment beams.
- 1120 35. **TPPC-20: Step & Shoot Beam Retrieval:** In the Step & Shoot Beam Retrieval transaction, a *Step & Shoot Beam Consumer* or a *TMS* receives a treatment plan from the *Archive*. The treatment plan shall contain only step & shoot IMRT treatment beams.
- 1125 36. **TPPC-21: Sliding Window Beam Storage:** In the Sliding Window Beam Storage transaction, a *Sliding Window Beam Producer* stores a treatment plan to the *Archive*. The treatment plan shall contain only sliding window IMRT treatment beams.

- 1110 37. **TPPC-22: Sliding Window Beam Retrieval:** In the Sliding Window Beam Retrieval transaction, a *Sliding Window Beam Consumer* or a *TMS* receives a treatment plan from the *Archive*. The treatment plan shall contain only sliding window IMRT treatment beams.
38. **TPPC-23: IMAT/VMAT Beam Storage:** In the IMAT/VMAT Beam Storage transaction, an *IMAT/VMAT Beam Producer* stores a treatment plan to the *Archive*. The treatment plan shall contain only IMAT/VMAT IMRT treatment beams.
- 1115 39. **TPPC-24: IMAT/VMAT Beam Retrieval:** In the IMAT/VMAT Beam Retrieval transaction, an *IMAT/VMAT Beam Consumer* or a *TMS* receives a treatment plan from the *Archive*. The treatment plan shall contain only IMAT/VMAT IMRT treatment beams.
- 1120 40. **TPPC-25: Photon Applicator Beam Storage:** In the Photon Applicator Beam Storage transaction, a *Photon Applicator Beam Producer* stores a treatment plan to the *Archive*. The treatment plan shall contain only static treatment beams using photon applicators.
41. **TPPC-26: Photon Applicator Beam Retrieval:** In the Photon Applicator Beam Retrieval transaction, a *Photon Applicator Beam Consumer* or a *TMS* receives a treatment plan from the *Archive*. The treatment plan shall contain only static treatment beams using photon applicator.
- 1125 42. **TPPC-27: Photon Applicator Arc Beam Storage:** In the Stereotactic Arc Beam Storage transaction, a *Stereotactic Arc Beam Producer* stores a treatment plan to the *Archive*. The treatment plan shall contain only stereotactic arc treatment beams.
- 1130 43. **TPPC-28: Photon Applicator Arc Beam Retrieval:** In the Stereotactic Arc Beam Retrieval transaction, a *Stereotactic Arc Beam Consumer* or a *TMS* receives a treatment plan from the *Archive*. The treatment plan shall contain only stereotactic arc treatment beams.

The following table shows which transactions are used in which Integration Profiles.

Table B-1: Integration Profile Transactions

Integration Profile Transaction	BRTO-II	MMRO-III
Single/Contoured Image Series Retrieval	X	
Structure Set Storage	X	
Dosimetric Plan Storage	X	
Dose Storage	X	
Multi-Series Image Retrieval	X	
Structure Set Retrieval	X	
Dosimetric Plan Retrieval	X	
Dose Retrieval	X	
Resampled/ Combined CT Series Storage	X	
Registered Structure Set Storage		X
Registered Structure Set Retrieval		X
Registered Dose Retrieval		X
Spatial Registration Storage		X

Integration Profile Transaction	BRTO-II	MMRO-III
Spatial Registration Retrieval		X

1135 **IHE Glossary**

IHE Glossary terms are maintained via the [Standards Knowledge Management Tool](#) (SKMT).

SKMT contains IHE Glossary Terms from Final Text and Trial Implementation IHE profiles. Terms from Public Comment profiles are added once the profile is published for Trial Implementation.

1140 The current published version of the IHE Glossary ([Appendix D](#) to the *IHE Technical Frameworks General Introduction*) contains IHE Glossary terms as of the publication date of the document. Always refer to the [SKMT](#) for the most up-to-date list of IHE Glossary terms.

Further information about SKMT can be found on the IHE Wiki [here](#).

Radiation Oncology Glossary Terms

1145 **Dosimetric Plan:** an RT Plan object containing sufficient information to dosimetrically define a radiation therapy treatment. The Dosimetric Plan shall contain references to RT Structure Set and RT Dose objects. A Dosimetric Plan shall contain a Fraction Group Sequence (300A,0070) containing a single sequence item. Each beam in the Referenced Beam Sequence (300C,0004) shall have its Beam Meterset (300A,0086) defined.

1150