

Integrating the Healthcare Enterprise



5

**IHE Pharmacy  
Technical Framework Supplement**

10

**Community Medication Prescription and  
Dispense  
(CMPD)**

15

**Rev. 1.9 – Trial Implementation**

20

Date: February 17, 2022  
Author: IHE Pharmacy Technical Committee  
Email: [pharmacy@ihe.net](mailto:pharmacy@ihe.net)

25

**Please verify you have the most recent version of this document. See [here](#) for Trial Implementation and Final Text versions and [here](#) for Public Comment versions.**

## Foreword

30 This is a supplement to the future IHE Pharmacy Technical Framework. Each supplement undergoes a process of public comment and trial implementation before being incorporated into the volumes of the Technical Frameworks.

This supplement is published on February 17, 2022 for trial implementation and may be available for testing at subsequent IHE Connectathons. The supplement may be amended based on the results of testing. Following successful testing it will be incorporated into the future  
35 Pharmacy Technical Framework. Comments are invited and may be submitted at [Pharmacy Public Comments](#).

This supplement describes changes to the existing technical framework documents.

“Boxed” instructions like the sample below indicate to the Volume Editor how to integrate the relevant section(s) into the relevant Technical Framework volume.

40 *Amend Section X.X by the following:*

Where the amendment adds text, make the added text **bold underline**. Where the amendment removes text, make the removed text **~~bold strikethrough~~**. When entire new sections are added, introduce with editor’s instructions to “add new text” or similar, which for readability are not bolded or underlined.

45

General information about IHE can be found at [IHE](#).

Information about the IHE Pharmacy domain can be found at [IHE Domains](#).

Information about the organization of IHE Technical Frameworks and Supplements and the process used to create them can be found at [Profiles](#) and [IHE Process](#)

50 The current versions of the Pharmacy Technical Framework supplements can be found at [Pharmacy Technical Framework](#).

## CONTENTS

55	Introduction to this Supplement.....	5
	Open Issues and Questions .....	6
	Closed Issues .....	6
	IHE Technical Frameworks General Introduction.....	8
60	9 Copyright Licenses.....	8
	10 Trademark .....	8
	IHE Technical Frameworks General Introduction Appendices.....	9
	Appendix A – Actors .....	9
	Appendix B – Transactions.....	10
65	Appendix D – Glossary.....	11
	<b>Volume 1 – Integration Profiles.....</b>	<b>12</b>
	1.10 History of Annual Changes.....	12
	2.5 Dependencies of the Pharmacy Integration Profiles .....	13
	4 Community Medication Prescription and Dispense Integration Profile .....	14
70	4.1 Actors/ Transactions.....	15
	4.1.1 Actors .....	19
	4.1.2 Transactions .....	22
	4.2 CMPD Actor Options.....	26
	4.2.1 Provision of Medication List Option.....	28
75	4.2.2 Persistence of Retrieved Documents Option.....	28
	4.2.3 Medication Treatment Planning Option.....	28
	4.2.4 Workflow Management Option .....	29
	4.2.5 Query Pharmacy Documents over SOAP Option .....	29
	4.2.6 Query Pharmacy Documents over MHD Option .....	29
80	4.3 CMPD Actor Groupings and Profile Interactions.....	30
	4.4 CMPD Process Flow .....	30
	4.4.1 Use Case community pharmacy-active substance, publish & pull (Scenario 1: “Including validation step, but not including planning and administration”) .....	31
85	4.4.2 Use Case community pharmacy-active substance, publish & pull (Scenario 2: “Including planning and administration, but not including validation step”) .....	34
	4.4.3 Use Case: Physician requests Medication List.....	38
	4.4.4 Use Case: Physician changes/cancels or suspends an unfilled prescription .....	39
	4.4.5 Use Case: Physician changes/stops or suspends the treatment with an already dispensed medication.....	41
90	4.4.6 Use Case: Physician documents a medication-related issue after a chemotherapy medication was administered.....	42
	4.5 CMPD Security Considerations .....	43
	4.6 CMPD Implementation Scenarios .....	43
	4.6.1 Usage of CMPD in a “single-domain” scenario.....	44

95	4.6.2 Usage of CMPD in a “multi-domain” scenario.....	56
	Appendices to Volume 1.....	65
	<b>Volume 2 – Transactions.....</b>	<b>66</b>
	3.0 IHE Transactions .....	66
	3.1 Query Pharmacy Documents [PHARM-1] .....	66
100	3.1.1 Scope .....	66
	3.1.2 Use Case Roles.....	67
	3.1.3 Referenced Standard .....	69
	3.1.4 Messages .....	69
	3.1.5 Security Considerations.....	110
105	3.2 Query Pharmacy Documents over MHD [PHARM-5].....	115
	3.2.1 Scope .....	115
	3.2.2 Use Case Roles.....	116
	3.2.3 Actors and Grouping .....	116
	3.2.4 Referenced Standard .....	117
110	3.2.5 Messages .....	118
	3.2.6 Security Considerations.....	123
	4 Workflow Definitions .....	129
	4.1 Community Medication Prescription and Dispense Workflow Definition (CMPD-WD)	
	129	
115	4.1.1 Actors and Grouping.....	129
	4.1.2 XDW Workflow Document – Common Attributes.....	130
	4.1.3 Workflow Task Definition.....	131

120

## Introduction to this Supplement

125 The Community Medication Prescription and Dispense Integration Profile (CMPD) describes the process of prescription, validation, dispense and administration of medication in the community domain. This document is a detailed description of the generic implementation structure defined in the Common Parts document<sup>1</sup>.

In general, the medication business process consists of five distinct processes, which have to be connected through interactions that transfer information and/or guide the workflow. The following figure shows this flow:

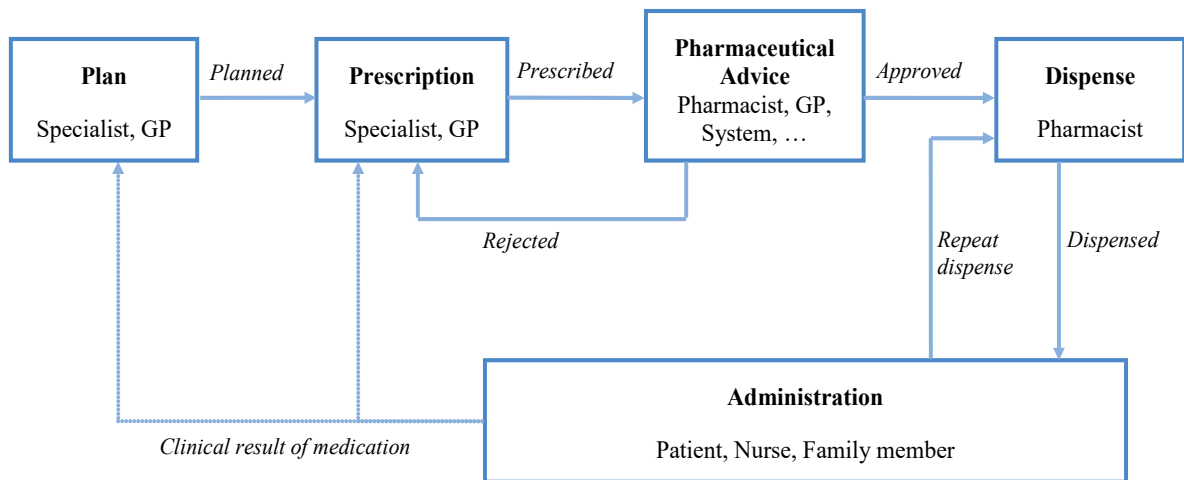

130

In the Community Pharmacy domain, the processes of “Planning”, “Prescription”, “Pharmaceutical Advice”, “Dispense” and “Administration” are covered by the Community Medication Prescription and Dispense Profile.

The CMPD Profile is intended to be used in the context of the Pharmacy Content Profiles<sup>2</sup>:

135

- Community Medication Treatment Plan (MTP)
- Community Prescription Supplement (PRE)

---

<sup>1</sup> This document is part of the IHE Pharmacy domain and can be obtained from the IHE web site.

<sup>2</sup> These supplements are part of the IHE Pharmacy domain and can be obtained from the IHE web site.

- Community Pharmaceutical Advice Supplement (PADV)
- Community Dispense Supplement (DIS)
- Community Medication Administration (CMA)
- 140 • Community Medication List (PML)

These Content Profiles are based on the Patient Care Coordination (PCC) Technical Framework and define the semantic of the payload transported by the CMPD Profile.

This supplement also references other documents<sup>3</sup>. The reader should have already read and understood these documents:

- 145 1. [PHARM Common parts document](#)
2. [IT Infrastructure Technical Framework Volume 1](#)
3. [IT Infrastructure Technical Framework Volume 2](#)
4. [IT Infrastructure Technical Framework Volume 3](#)
5. HL7 and other standards documents referenced in this document

## 150 **Open Issues and Questions**

- Grouping of XDW with the Community Pharmacy Manager: What, if the client-side actors (Prescription Placer, Pharmaceutical Adviser, Medication Dispenser) are not allowed to manage the workflow and this should be done by the CPM.

## **Closed Issues**

- 155 • Question: Should be medication processes message or document-based? Decision at F2F meeting in Bordeaux (15./16.04.2010): Community domain is document based with XDS as persistence layer, Hospital domain will be message-based.
- Clarification to white paper: In community domain, the term “repository” in the whitepaper is intended to be interpreted as a technical system for persisting documents implementing XDS transactions as interface. XDS registry/repository systems as well as database or other persisting systems are likely to be used for this purpose.
- 160 • Changes to white paper: “Consumer” actors will be removed because they are just relaying transactions (don’t implement any own transactions). Sequence diagrams have been adapted.

---

<sup>3</sup> The first document is located on the IHE Website at [https://www.ihe.net/resources/technical\\_frameworks/](https://www.ihe.net/resources/technical_frameworks/). The ITI Technical Framework can be found at <https://profiles.ihe.net/ITI/TF/index.html>. The remaining documents can be obtained from their respective publishers.

---

- 165
- The transient aspects of “Ordering” are excluded in the profile. This should be generally discussed together with ITI in conjunction with all other “Ordering/Workflow” topics (e.g., Lab, Referral, etc.). (see CP-PHARM-018\_v5)
  - The profile does not yet include the process step of getting the “current medication”, which is needed for checking interactions (ICAs) to the prescribed item.
- 170           This issue is closed since the introduction of PML.

## IHE Technical Frameworks General Introduction

The [IHE Technical Frameworks General Introduction](#) is shared by all of the IHE domain technical frameworks. Each technical framework volume contains links to this document where appropriate.

### 175 **9 Copyright Licenses**

IHE technical documents refer to, and make use of, a number of standards developed and published by several standards development organizations. Please refer to the IHE Technical Frameworks General Introduction, [Section 9 - Copyright Licenses](#) for copyright license information for frequently referenced base standards. Information pertaining to the use of IHE International copyrighted materials is also available there.

### **10 Trademark**

IHE<sup>®</sup> and the IHE logo are trademarks of the Healthcare Information Management Systems Society in the United States and trademarks of IHE Europe in the European Community. Please refer to the IHE Technical Frameworks General Introduction, [Section 10 - Trademark](#) for information on their use.



## IHE Technical Frameworks General Introduction Appendices

190 The [IHE Technical Framework General Introduction Appendices](#) are components shared by all of the IHE domain technical frameworks. Each technical framework volume contains links to these documents where appropriate.

195 *Update the following appendices to the General Introduction as indicated below. Note that these are **not** appendices to this domain’s Technical Framework (TF-1, TF-2, TF-3 or TF-4) but rather, they are appendices to the IHE Technical Frameworks General Introduction located [here](#).*

### [Appendix A](#) – Actors

200 *Add the following **new or modified** actors to the [IHE Technical Frameworks General Introduction Appendix A](#):*

New (or modified) Actor Name	Description
No new actors	

The table below lists *existing* actors that are utilized in this profile.

#### Complete List of Existing Actors Utilized in this Profile

Existing Actor Name	Definition
Community Pharmacy Manager	Actor providing the business logic for status management and other purposes.
Medication Treatment Planner	Actor for planning a new medication (introducing a new medication into the patient’s treatment plan). It provides Community Medication Treatment Plan documents each containing one Medication Treatment Plan Item representing the planned medication.
Prescription Placer	Actor for placing prescriptions. It provides Community Prescription documents containing one or more Prescription Items representing the prescribed medication.
Pharmaceutical Adviser	Actor responsible for the validation or review of Medication Treatment Plan-, Prescription-, Dispense- or Medication Administration Items. It provides the Community Pharmaceutical Advice document as the result of the validation or review. Pharmaceutical Advisers (e.g., pharmacists, physicians, automated ICA check modules, etc.) may also provide “draft” advices which don’t affect the status of a prescription but serve as a foundation for the advice performed by another Pharmaceutical Adviser. Pharmaceutical Adviser may also manage, review or comment a Medication Treatment Plan, Prescription, Dispense or Medication Administration.

Existing Actor Name	Definition
Medication Dispenser	Actor responsible for the process of dispensing medication to the patient, possibly fulfilling an underlying prescription and/or treatment plan. It may receive treatment plans or prescriptions already validated and provides a Community Dispense document as result of the act of delivering the medication to the patient.
Medication Administration Performer	Actor responsible for the process of administering medication to the patient, possibly fulfilling an underlying prescription and/or treatment plan. It may receive treatment plans or prescriptions already dispensed and provides an administration document as result of the act of administering the medication to the patient.
Repository	Formally the Community Pharmacy process defines different “repositories” for Medication Treatment Plans, Prescriptions, Pharmaceutical Advices, Dispenses and Medication Administrations, but they shall be seen as abstract repository-roles for persisting the appropriate documents, not as XDS repositories defined in the “Cross Document Sharing” (XDS) Integration Profile of the ITI Technical Framework.

205

## Appendix B – Transactions

210

Add the following **new or modified** transactions to the [IHE Technical Frameworks General Introduction Appendix B](#):

New (or modified) Transaction Name and Number	Definition
Query Pharmacy Documents [PHARM-1]	This transaction defines how a querying actor has to query the Community Pharmacy Manager for Community Medication Treatment Plans (MTP) and Community Prescriptions (PRE) and their related documents. Related documents are Community Pharmaceutical Advice (PADV) and Community Dispense (DIS) documents. It defines specialized queries to allow the finding of plans or prescriptions and their related documents for specific purposes (e.g., “for validation” or “for dispense”).
Query Pharmacy Documents over MHD [PHARM-5]	This transaction defines how a querying actor has to query the Community Pharmacy Manager for Community Medication Treatment Plans (MTP) and Community Prescriptions (PRE) and their related documents. Related documents are Community Pharmaceutical Advice (PADV) and Community Dispense (DIS) documents. It defines specialized queries to allow the finding of plans or prescriptions and their related documents for specific purposes (e.g., “for validation” or “for dispense”).

215 **Appendix D** – Glossary

*Add the following **new or modified** glossary terms to the [IHE Technical Frameworks General Introduction Appendix D](#):*

<b>New (or modified) Glossary Term</b>	<b>Definition</b>	<b>Synonyms</b>	<b>Acronym/ Abbreviation</b>
No new terms			

220

## Volume 1 – Integration Profiles

*Add the following to Section 1.10*

225

### 1.10 History of Annual Changes

- In the 2022 cycle, the supplement was updated based on CP-PHARM-142, CP-PHARM-144, CP-PHARM-145, and CP-PHARM-146.
- The 2020-2021 cycle of IHE Pharmacy initiative introduced the following changes or additions:
  - PHARM-5 transaction for allowing CMPD Actors to use a RESTful communication protocol (MHD-based) as underlying transport mechanism. As a consequence, PHARM-1 is made optional (support for either or both SOAP-based or RESTful-based communication);
  - PHARM-1 support for cross-community communication in order to allow a CMPD Manager from one community to forward a request to a CMPD Manager from another community;
  - Various clarifications as part of the general maintenance of the profile.
- The 2018-2019 cycle of IHE Pharmacy initiative introduced the notion of “provisional prescription”, for handling scenarios like a patient going to a community pharmacy and asking for dispense on a prescription he or she will get the day after. The selected implementation aims at minimizing the impact on existing implementations while offering a solution to such common situations respecting the spirit of the CMPD workflow.
- In the 2017-2018 cycle of the IHE Pharmacy initiative, the following major changes were introduced to this supplement (please see the list of this year’s change proposals for the complete set of changes at <https://drive.google.com/drive/folders/13jNXdHJZig9w2mCbot87xHjU-wf2IFb0>):
  - “Medication Administration” has been added to the CMPD process. See new Community Medication Administration (CMA) Profile for the Content definition.
  - All references regarding a “filtering/relaying capability” of the Community Pharmacy Manager have been removed. No such capability is defined at the CPM actor anymore and have also been removed from CMPD implementation scenarios.
  - The description of the Query Pharmacy Documents (PHARM-1) transaction has been extensively overworked for more precise definition of the expected return of the different queries and better readability. Ambiguities have been clarified.

- Workflow definitions chapter 4 has been extensively overworked for better readability and alignment to the current version of the XDW Profile.

260 **2.5 Dependencies of the Pharmacy Integration Profiles**

*Add the following to Table 2-1*

Community Medication Prescription and Dispense CMPD	XDS	CMPD actors are based on XDS Document Source, Document Consumer, Registry and Repository Actors and use XDS transactions.	Required to manage query, submission and retrieve of documents.
Community Medication Prescription and Dispense CMPD	On-Demand Documents	CMPD Community Pharmacy Manager acts as an On-Demand Document Source	Required to manage request of the Medication List
Community Medication Prescription and Dispense CMPD	ATNA	Each CMPD actor shall be grouped with Secure Node or Secure Application Actor	Required due to XDS grouping.
Community Medication Prescription and Dispense CMPD	CT	Each CMPD actor shall be grouped with the Time Client	Required due to ATNA grouping.
Community Medication Prescription and Dispense CMPD	XDW	Some CMPD actors can be optionally grouped with XDW Workflow Management	Optional due to XDW grouping
Community Medication Prescription and Dispense CMPD	MHD	CMPD manager can be optionally grouped with MHD	Optional due to MHD grouping
Community Medication Prescription and Dispense CMPD	XCA	Some CMPD actors can be optionally grouped with XCA Actors	Optional due to XCA grouping

*Add Section 4*

265 **4 Community Medication Prescription and Dispense Integration Profile**

The Community Medication Prescription and Dispense Integration Profile (CMPD) describes the process of planning, prescription, validation, dispense and administration of medication in the community domain.

270 In general, the medication business process consists of five distinct processes, which have to be connected through interactions that transfer information and/or guide the workflow. The following figure shows this flow:

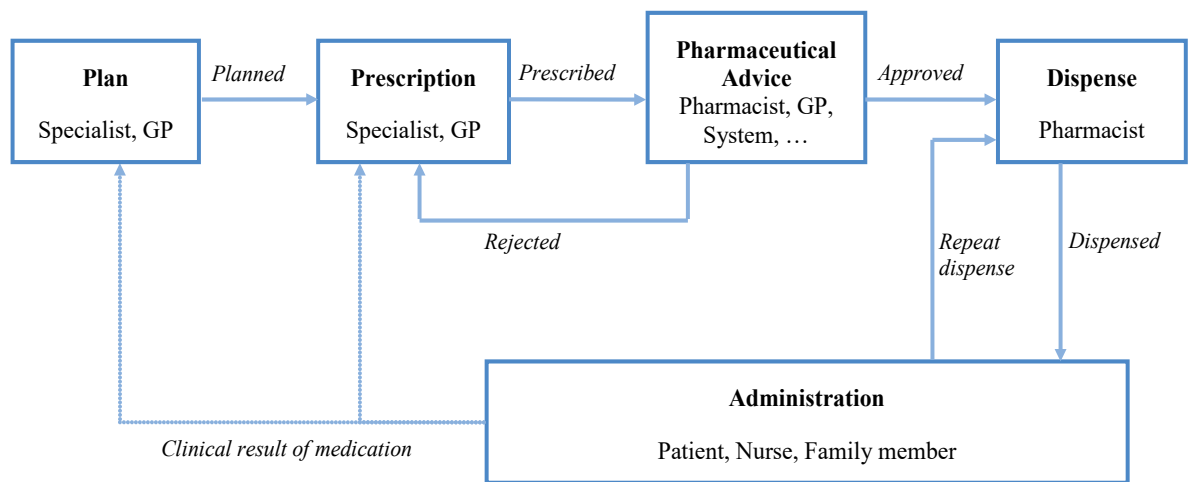

275 **Figure 4-1: Medication Planning, Prescription, Dispense and Administration Process**

The CMPD Profile is intended to be used in the context of the Pharmacy Content Profiles<sup>4</sup>:

- Community Medication Treatment Plan (MTP)
- Community Prescription Supplement (PRE)
- Community Pharmaceutical Advice Supplement (PADV)
- Community Dispense Supplement (DIS)
- Community Medication Administration (CMA)

---

<sup>4</sup> These supplements are part of the IHE Pharmacy domain and can be obtained from the IHE web site.

---

- Community Medication List (PML)

These Content Profiles are based on the Patient Care Coordination (PCC) Technical Framework and define the semantic of the payload transported by the CMPD Profile.

285 **4.1 Actors/ Transactions**

Figure 4.1-1 shows the actors directly involved in the Community Medication Prescription and Dispense Integration Profile and the relevant transactions between them when communication is based on SOAP communication protocol. Figure 4.1-2 shows the same when communication is based on RESTful protocol. Other actors that may be indirectly involved due to their participation in the XDS integration profiles, etc., are not necessarily shown.

290

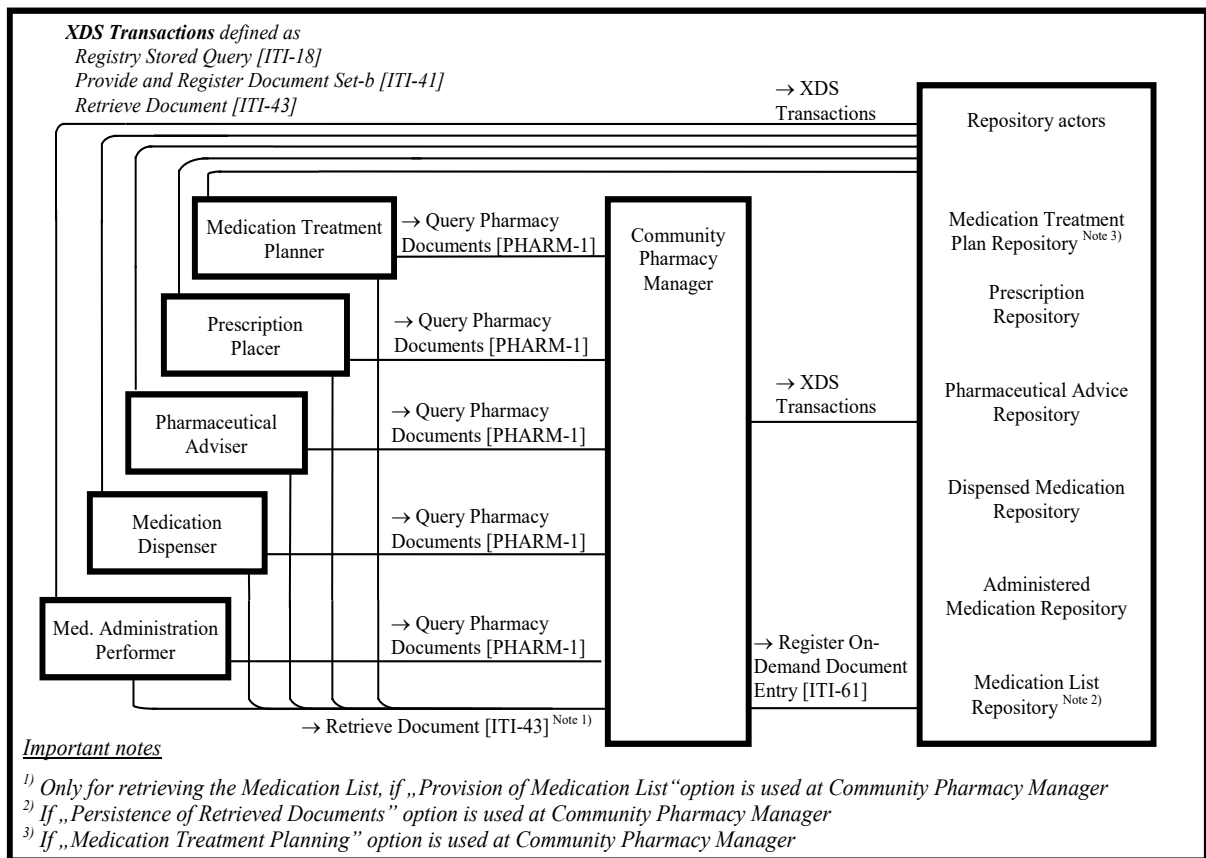

**Figure 4.1-1: Community Medication Prescription and Dispense Actor Diagram**

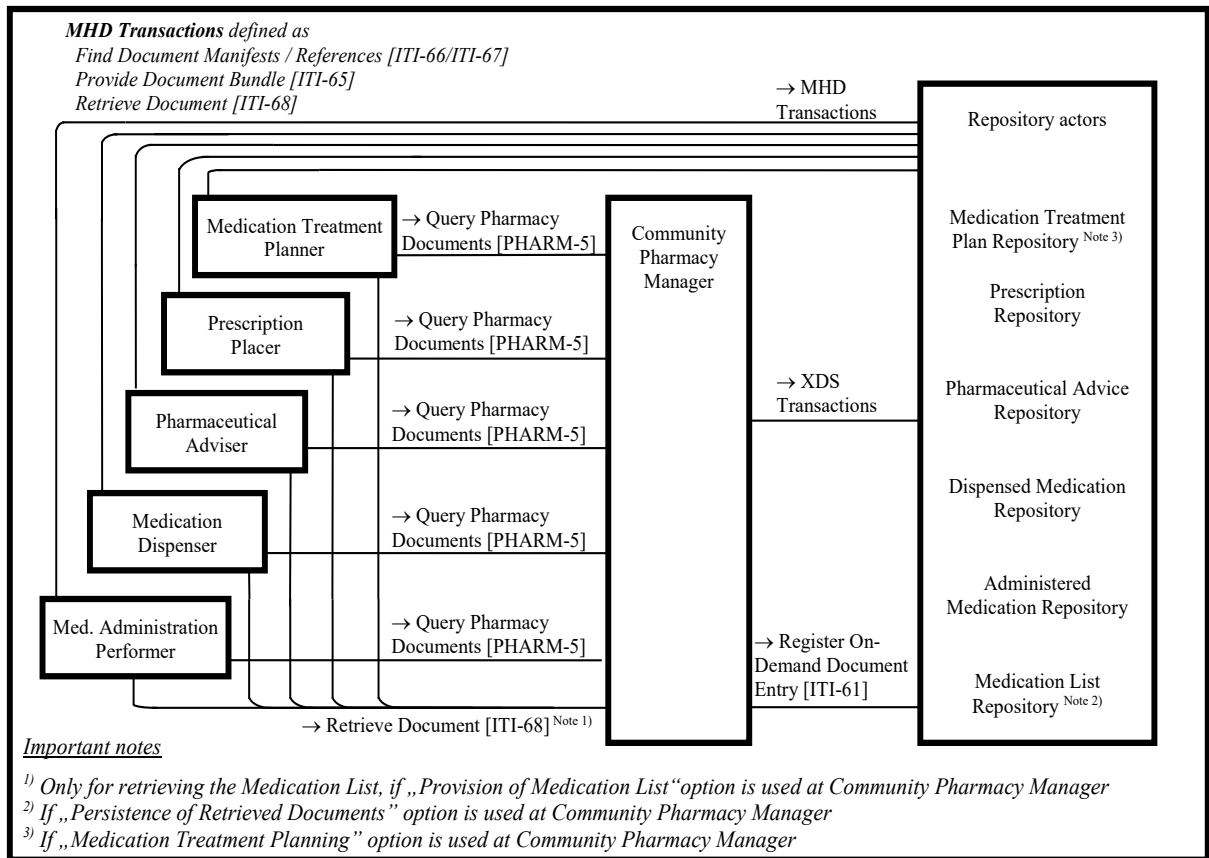

**Figure 4.1-2: Community Medication Prescription and Dispense Actor Diagram (RESTful based)**

295

Table 4.1-1 lists the transactions for each actor directly involved in the Community Medication Prescription and Dispense Profile. In order to claim support of this Integration Profile, an implementation must perform the required transactions (labeled “R”). Transactions labeled “O” are optional. A complete list of options defined by this Integration Profile and that implementations may choose to support is listed in Volume 1, Section 4.2.

300

**Table 4.1-1: Community Medication Prescription and Dispense Integration Profile - Actors and Transactions**

Actors	Transactions	Optionality	Section in Vol. 2
Community Pharmacy Manager	Registry Stored Query [ITI-18] (acting as a Document Consumer)	R	ITI TF-2: 3.18
	Retrieve Document Set [ITI-43] (acting as a Document Consumer)	R	ITI TF-2: 3.43



IHE Pharmacy Technical Framework Supplement – Community Medication Prescription and Dispense (CMPD)

<b>Actors</b>	<b>Transactions</b>	<b>Optionality</b>	<b>Section in Vol. 2</b>
	Register On-Demand Document Entry [ITI-61] (acting as an On-Demand Document Source)	O <sup>1,5</sup>	ITI TF-2: 3.61
	Query Pharmacy Documents [PHARM-1]	O <sup>5</sup>	PHARM TF-2: 3.1
	Find Document Manifests [ITI-66]	O <sup>2</sup>	ITI TF-2: 3.66
	Find Document References [ITI-67]	O <sup>2</sup>	ITI TF-2: 3.67
	Provide Document Bundle [ITI-65]	O <sup>2</sup>	ITI TF-2: 3.65
	Retrieve Document [ITI-68]	O <sup>2</sup>	ITI TF-2: 3.68
	Query Pharmacy Documents over MHD [PHARM-5]	O <sup>2</sup>	PHARM TF-2: 3.2
Medication Treatment Planner	Registry Stored Query [ITI-18]	O <sup>3,5</sup>	ITI TF-2: 3.18
	Provide and Register Document Set-b [ITI-41]	O <sup>5</sup>	ITI TF-2: 3.41
	Retrieve Document Set [ITI-43]	O <sup>5</sup>	ITI TF-2: 3.43
	Query Pharmacy Documents [PHARM-1]	O <sup>5</sup>	PHARM TF-2: 3.1
	Find Document Manifests [ITI-66]	O <sup>2</sup>	ITI TF-2: 3.66
	Find Document References [ITI-67]	O <sup>2</sup>	ITI TF-2: 3.67
	Provide Document Bundle [ITI-65]	O <sup>2</sup>	ITI TF-2: 3.65
	Retrieve Document [ITI-68]	O <sup>2</sup>	ITI TF-2: 3.68
Query Pharmacy Documents over MHD [PHARM-5]	O <sup>2</sup>	PHARM TF-2: 3.2	
Prescription Placer	Registry Stored Query [ITI-18]	O <sup>3,5</sup>	ITI TF-2: 3.18
	Provide and Register Document Set-b [ITI-41]	O <sup>5</sup>	ITI TF-2: 3.41
	Retrieve Document Set [ITI-43]	O <sup>5</sup>	ITI TF-2: 3.43
	Query Pharmacy Documents [PHARM-1]	O <sup>5</sup>	PHARM TF-2: 3.1
	Find Document Manifests [ITI-66]	O <sup>2</sup>	ITI TF-2: 3.66
	Find Document References [ITI-67]	O <sup>2</sup>	ITI TF-2: 3.67
	Provide Document Bundle [ITI-65]	O <sup>2</sup>	ITI TF-2: 3.65
	Retrieve Document [ITI-68]	O <sup>2</sup>	ITI TF-2: 3.68
	Query Pharmacy Documents over MHD [PHARM-5]	O <sup>2</sup>	PHARM TF-2: 3.2
Pharmaceutical Adviser	Registry Stored Query [ITI-18]	O <sup>3,5</sup>	ITI TF-2: 3.18
	Provide and Register Document Set-b [ITI-41]	O <sup>5</sup>	ITI TF-2: 3.41
	Retrieve Document Set [ITI-43]	O <sup>5</sup>	ITI TF-2: 3.43

IHE Pharmacy Technical Framework Supplement – Community Medication Prescription and Dispense (CMPD)

Actors	Transactions	Optionality	Section in Vol. 2	
	Query Pharmacy Documents [PHARM-1]	O <sup>5</sup>	PHARM TF-2: 3.1	
	Find Document Manifests [ITI-66]	O <sup>2</sup>	ITI TF-2: 3.66	
	Find Document References [ITI-67]	O <sup>2</sup>	ITI TF-2: 3.67	
	Provide Document Bundle [ITI-65]	O <sup>2</sup>	ITI TF-2: 3.65	
	Retrieve Document [ITI-68]	O <sup>2</sup>	ITI TF-2: 3.68	
	Query Pharmacy Documents over MHD [PHARM-5]	O <sup>2</sup>	PHARM TF-2: 3.2	
Medication Dispenser	Registry Stored Query [ITI-18]	O <sup>3,5</sup>	ITI TF-2: 3.18	
	Provide and Register Document Set-b [ITI-41]	O <sup>5</sup>	ITI TF-2: 3.41	
	Retrieve Document Set [ITI-43]	O <sup>5</sup>	ITI TF-2: 3.43	
	Query Pharmacy Documents [PHARM-1]	O <sup>5</sup>	PHARM TF-2: 3.1	
	Find Document Manifests [ITI-66]	O <sup>2</sup>	ITI TF-2: 3.66	
	Find Document References [ITI-67]	O <sup>2</sup>	ITI TF-2: 3.67	
	Provide Document Bundle [ITI-65]	O <sup>2</sup>	ITI TF-2: 3.65	
	Retrieve Document [ITI-68]	O <sup>2</sup>	ITI TF-2: 3.68	
Medication Administration Performer	Registry Stored Query [ITI-18]	O <sup>3,5</sup>	ITI TF-2: 3.18	
	Provide and Register Document Set-b [ITI-41]	O <sup>5</sup>	ITI TF-2: 3.41	
	Retrieve Document Set [ITI-43]	O <sup>5</sup>	ITI TF-2: 3.43	
	Query Pharmacy Documents [PHARM-1]	O <sup>5</sup>	PHARM TF-2: 3.1	
	Find Document Manifests [ITI-66]	O <sup>2</sup>	ITI TF-2: 3.66	
	Find Document References [ITI-67]	O <sup>2</sup>	ITI TF-2: 3.67	
	Provide Document Bundle [ITI-65]	O <sup>2</sup>	ITI TF-2: 3.65	
	Retrieve Document [ITI-68]	O <sup>2</sup>	ITI TF-2: 3.68	
	Query Pharmacy Documents over MHD [PHARM-5]	O <sup>2</sup>	PHARM TF-2: 3.2	
Repository actors	Registry Stored Query [ITI-18]	R	ITI TF-2: 3.18	
	• Medication Treatment Plan <sup>4</sup>	Provide and Register Document Set-b [ITI-41]	R	ITI TF-2: 3.41
	• Prescription Pharmaceutical Advice	Retrieve Document Set [ITI-43]	R	ITI TF-2: 3.43
	• Dispensed Medication	Find Document Manifests [ITI-66]	O <sup>2</sup>	ITI TF-2: 3.66
	• Administered Medication	Find Document References [ITI-67]	O <sup>2</sup>	ITI TF-2: 3.67
	• Medication List <sup>7</sup>	Provide Document Bundle [ITI-65]	O <sup>2</sup>	ITI TF-2: 3.65
		Retrieve Document [ITI-68]	O <sup>2</sup>	ITI TF-2: 3.68

Notes:

- 305
1. R if “Provision of Medication List” Option is used
  2. R if “Query Pharmacy Documents over MHD” Option is used
  3. R if “Workflow Management” Option is used
  4. R if “Medication Treatment Plan” Option is used
  5. R if “Query Pharmacy Documents over SOAP” Option is used
  6. If “Persistence of Retrieved Documents” Option is used at Community Pharmacy Manager

310

## 4.1.1 Actors

### 4.1.1.1 Community Pharmacy Manager

315 The role of this actor consists in providing the business logic for status management and other purposes. It may also serve as provider of the business logic for creating the Medication List if “Provision of Medication List” Option is supported.

320 It provides special query-transactions which consuming actors (Medication Treatment Planner, Prescription Placer, Pharmaceutical Adviser, Medication Dispenser or Medication Administration Performer) use for reducing the amount of data flowing to them. They return just “relevant” information for specific purposes (e.g., returning just all “active” prescriptions ready for being validated or dispensed together with all related documents).

325 Furthermore it may provide special query-transactions which consuming actors (Medication Treatment Planner, Prescription Placer, Pharmaceutical Adviser, Medication Dispenser or Medication Administration Performer) use to request a Medication List to a patient. Fulfilling the request the actor gathers and assembles Medication Treatment Plan-, Prescription-, Dispense and Medication Administration Items to a Community Medication List document according to the “Community Medication List” (PML) Profile. Subsequently this resulting document is returned to the requesting actor. For this functionality this actor acts as an ITI On-Demand Document Source as described in the “On-Demand documents” supplement.

This actor is usually a system actor without human participation.

### 330 4.1.1.2 Medication Treatment Planner

The main role of this actor consists in adding a new Medication Treatment Plan Item. It sends the cancelation of the planned item or its discontinuation, as well. In order to fulfill this task, the Medication Treatment Planner retrieves the current set of planned medications of the patient.

### 4.1.1.3 Prescription Placer

335 The main role of this actor consists in placing the prescription (initial or modified in case of a substitution or invalidation, for example). It sends the cancelation of the prescription or its

discontinuation, as well. In order to fulfill this task, the Prescription Placer retrieves the current treatment of the patient and medication already dispensed recently.

#### **4.1.1.4 Pharmaceutical Adviser**

340 This actor is responsible for the validation of prescriptions from a pharmacist’s perspective. Therefore, it receives the initial prescription, validates it and sends it back (accepted, cancelled, modified, substitution of pharmaceutical product); therefore it provides the pharmaceutical advice. To perform this task it checks the current treatment.

345 Pharmaceutical Advisers (e.g., automated ICA check modules) may also provide “draft” advices which don’t affect the status of a prescription but serve as a foundation for the advice performed by another Pharmaceutical Adviser.

Pharmaceutical Advisers may also review or manage medication treatment plan, prescription or dispenses – e.g., adding comments related to the medication, modifying the dosage or stopping a medication.

350 Pharmaceutical Adviser role may also be undertaken by a prescriber in order to validate (approve, cancel, modify, substitute) a prescription containing provisional Prescription Items. Prescriptions containing provisional Prescription Items may be issued in many cases, for example, in the situation where expected prescriptions of long-care or elderly patients are prepared by the caring facility to the prescriber, or the situation where the pharmacist dispenses medications before the formal prescription has been issued (which requires the issuing of a prescription containing provisional Prescription Items by the pharmacist to establish the links between the (later issued) formal prescription and this dispense. Prescriptions containing provisional Prescription Items have to be handled by the Community Medication Prescription and Dispense Actor according to Workflow scenario 1 described in Section 4.4 even if the domain operates according to Workflow scenario 2.

360

#### **4.1.1.5 Medication Dispenser**

365 This actor is responsible for the process of dispensing medication to the patient, e.g., fulfilling the prescription and/or a treatment plan. Therefore it produces the information on the medication dispensed to the patient. In order to achieve this, it may receive prescriptions already validated and underlying treatment plans, if available. It also confirms drug availability for administration and it may receive the administration plan and/or administration reports. This actor may be implemented as the point of sale software of a community pharmacy or the hospital pharmacy module of a hospital information system. The human actor behind this system actor is usually a pharmacist or a pharmacist assistant.

#### **4.1.1.6 Medication Administration Performer**

370 This actor is responsible for the process of administering medication to the patient, e.g., fulfilling the prescription and/or a treatment plan. Therefore it produces the information on the medication

375 administered to the patient. In order to achieve this, it may receive dispense records of the medication to administer and underlying prescriptions and a treatment plans, if available. It also confirms drug availability for administration and it may receive the administration plan and/or previous administration reports. This actor may be implemented as the point of sale software of a community pharmacy or the hospital pharmacy module of a hospital information system. The human actor behind this system actor is usually a physician or nurse.

#### 4.1.1.7 Repository actors

380 Formally, the Community Pharmacy process defined different “repositories” for Medication Treatment Plans, Prescriptions, Pharmaceutical Advices, Dispenses and Medication Administrations, but they shall be seen as abstract repository-roles for persisting the appropriate document types the documents, not as XDS repositories defined in the “Cross Document Sharing” (XDS) Integration Profile of the ITI Technical Framework.

385 This profile rather makes use of the XDS Profile for defining abstract XDS registry and repository actors for modeling the abstract repository-roles for real implementations.

Description of the abstract repository-roles:

- Medication Treatment Plan Repository

390 This repository contains the medication added to the patient’s plan from the Medication Treatment Planner and may receive updates to the current planning (cancelations, changes, etc.). It provides information about the planned medication to other actors such as the Community Pharmacy Manager.

- Prescription Repository

395 This repository contains the medication prescribed to the patient from the Prescription Placer and may receive updates to the current treatment (cancelations, changes, etc.). It provides information about the prescribed medication to other actors such as the Community Pharmacy Manager.

- Pharmaceutical Advice Repository

400 This repository contains the pharmaceutical advice issued by the Pharmaceutical Adviser (typically but not always a pharmacist). It provides this information to other actors such as the Community Pharmacy Manager.

- Dispensed Medication Repository

405 This repository contains the medication actually dispensed to the patient; this information is received from the Medication Dispenser. It provides the dispensed medication of the patient to other actors such as the Community Pharmacy Manager.

- Administered Medication Repository

410 This repository contains the medication actually administered to the patient; this information is received from the Medication Administration Performer. The Administered Medication Repository provides the administered medication of the patient to other actors such as the Community Pharmacy Manager.

Conforming to the ITI XDS Technical Framework, registry actors are used for storing metadata of the submitted documents, the repository actors store the actual documents.

415 Implementation scenarios in real-world projects will most likely differ from the topology of having exactly three repositories. They may vary from single XDS affinity domain scenarios with just one registry/repository system for storing all document-types to most complex scenarios including many different XDS affinity domains for covering the organizational and strategic need of separation of the participating parties (e.g., Prescribers and Pharmacists).

All mechanisms defined in the XDS Integration Profile for accessing XDS Registry/Repository systems apply and may be used for communicating, e.g., “Cross Community Access” (XCA).

## 420 4.1.2 Transactions

### 4.1.2.1 Query Pharmacy Documents [PHARM-1]

This transaction is supported if Query Pharmacy Documents over SOAP Option is used.

425 This transaction defines how a querying actor has to query the Community Pharmacy Manager for Community Medication Treatment Plans (MTP), Community Prescriptions (PRE), Community Dispenses (DIS) and administrations (CMA) and their related documents. Related documents may be Community Prescription (PRE)-, Community Dispense (DIS)-, Community Medication Administration (CMA)- and Community Pharmaceutical Advice (PADV) documents.

Querying actors may be:

- 430
- Medication Treatment Planner
  - Prescription Placer
  - Pharmaceutical Adviser
  - Medication Dispenser
  - Medication Administration Performer

435 This transaction provides a set of specialized queries:

(1) Specialized queries allow the finding of certain kind of documents and their related documents for specific purposes (e.g., for validation, for dispense, etc.).

These are:

- 440 • **FindMedicationTreatmentPlans (if “Medication Treatment Planning” Option is supported)**  
Find planned medication documents and their related documents
- **FindPrescriptions**  
Find prescription documents and their related documents
- **FindDispenses**  
445 Find dispense documents and their related documents
- **FindMedicationAdministrations**  
Find administered medication documents and their related documents
- **FindPrescriptionsForValidation**  
450 Find prescriptions and their related documents containing Prescription Items ready to be validated
- **FindPrescriptionsForDispense**  
Find prescriptions and their related documents containing Prescription Items ready to be dispensed

The last two queries can be parameterized to...

- 455 1. ... either check the status of a given prescription (e.g., if the patient shows the printed prescription to the operator and the prescription ID can be read off it).  
In this case the ID of the given prescription is set in the query parameters - if the prescription is in the requested status (e.g., “ready for dispense”) it shows up in the query result (together with its related documents); otherwise the query result is empty which  
460 indicates that the given prescription is not in the requested status.
  - 2. ... or to search for prescriptions which are in a specific status (e.g., if the patient has no printed prescription and the implementation allows searching for prescriptions).  
In this case the query returns all prescriptions which are in the requested status (e.g., “ready for dispense”). The operator can choose and pick the right one.
- 465 (2) A query for requesting the Medication List, if “Provision of Medication List” Option is supported.

This is:

- **FindMedicationList**  
Find the Medication List to a patient.

470 **4.1.2.2 Registry Stored Query [ITI-18]**

This transaction is supported if Query Pharmacy Documents over SOAP Option is used.

This transaction is used by a Medication Treatment Planner, Prescription Placer, Pharmaceutical Adviser, Medication Dispenser or Medication Administration Performer Actor to a registry actor (Medication Treatment Plan/Prescription/Pharmaceutical Advice/Dispensed  
475 Medication/Administered Medication registry) in order to query for Community Medication Treatment Plan-, Community Prescription-, Community Pharmaceutical Advice-, Community Dispense- or Community Medication Administration documents based on the querying actor's query parameters.

See the XDS Integration Profile of the ITI Technical Framework for a detailed description of this  
480 transaction (ITI TF2: 3.18).

**4.1.2.3 Provide and Register Document Set-b [ITI-41]**

This transaction is supported if Query Pharmacy Documents over SOAP Option is used.

This transaction is sent by a Medication Treatment Planner, Prescription Placer, Pharmaceutical Adviser, Medication Dispenser or Medication Administration Performer Actor to a repository  
485 actor (Medication Treatment Plan/Prescription/Pharmaceutical Advice/Dispensed Medication/Administered Medication Repository) in order to submitting one or more Community Medication Treatment Plan-, Community Prescription-, Community Pharmaceutical Advice-, Community Dispense- or Community Medication Administration documents. See the XDS Integration Profile of the ITI Technical Framework for a detailed description of this  
490 transaction (ITI TF2: 3.41).

**4.1.2.4 Retrieve Document Set [ITI-43]**

This transaction is supported if Query Pharmacy Documents over SOAP Option is used.

This transaction is sent by a Medication Treatment Planner, Prescription Placer, Pharmaceutical Adviser, Medication Dispenser or Medication Administration Performer Actor to a repository  
495 actor (Medication Treatment Plan/Prescription/Pharmaceutical Advice/Dispensed Medication/Administered Medication Repository) or the Community Pharmacy Manager Actor in order to retrieve one or more Community Medication Treatment Plan-, Community Prescription-, Community Pharmaceutical Advice-, Community Dispense- or Community Medication Administration documents.

See the XDS Integration Profile of the ITI Technical Framework for a detailed description of this  
500 transaction (ITI TF2: 3.43).



#### 4.1.2.5 Query Pharmacy Documents over MHD [PHARM-5]

505 This transaction is supported if Query Pharmacy Documents over MHD Option is used. It implements the same functionality as Query Pharmacy Documents transaction but is based on MHD instead of ITI-18.

Querying actors are the same as those described in section 4.1.2.1.

Query Pharmacy Documents over MHD supports operations which are equivalent to Query Pharmacy Documents specialized queries:

Query Pharmacy Documents over MHD Operation	Query Pharmacy Documents Equivalent Query
\$find-medication-treatment-plans	FindMedicationTreatmentPlans
\$find-prescriptions	FindPrescriptions
\$find-dispenses	FindDispenses
\$find-medication-administrations	FindMedicationAdministrations <sup>5</sup>
\$find-prescriptions-for-validation	FindPrescriptionsForValidation
\$find-prescriptions-for-dispense	FindPrescriptionsForDispense
\$find-medication-list	FindMedicationList

510

#### 4.1.2.6 Find Document Manifests [ITI-66]

515 This transaction is supported if Query Pharmacy Documents over MHD Option is used. It is used by a Medication Treatment Planner, Prescription Placer, Pharmaceutical Adviser, Medication Dispenser or Medication Administration Performer Actor to a registry actor (Medication Treatment Plan/Prescription/Pharmaceutical Advice/Dispensed Medication/Administered Medication registry) in order to query for Community Medication Treatment Plan-, Community Prescription-, Community Pharmaceutical Advice-, Community Dispense- or Community Medication Administration DocumentManifest Resources based on the querying actor’s query parameters.

520 See the MHD Integration Profile of the ITI Technical Framework for a detailed description of this transaction (ITI MHD: 3.66).

#### 4.1.2.7 Find Document References [ITI-67]

This transaction is supported if Query Pharmacy Documents over MHD Option is used. It is used by a Medication Treatment Planner, Prescription Placer, Pharmaceutical Adviser, Medication

---

<sup>5</sup> This query is not yet supported as Medication Administration is not supported.

525 Dispenser or Medication Administration Performer Actor to a registry actor (Medication  
 530 Treatment Plan/Prescription/Pharmaceutical Advice/Dispensed Medication/Administered  
 Medication registry) in order to query for Community Medication Treatment Plan-, Community  
 Prescription-, Community Pharmaceutical Advice-, Community Dispense- or Community  
 Medication Administration DocumentReference Resources based on the querying actor’s query  
 parameters.

See the MHD Integration Profile of the ITI Technical Framework for a detailed description of  
 this transaction (ITI MHD: 3.67).

**4.1.2.8 Provide Document Bundle [ITI-65]**

535 This transaction is supported if Query Pharmacy Documents over MHD Option is used. It is sent  
 by a Medication Treatment Planner, Prescription Placer, Pharmaceutical Adviser, Medication  
 Dispenser or Medication Administration Performer Actor to a repository actor (Medication  
 Treatment Plan/Prescription/Pharmaceutical Advice/Dispensed Medication/Administered  
 Medication Repository) in order to submitting one or more Community Medication Treatment  
 540 Plan-, Community Prescription-, Community Pharmaceutical Advice-, Community Dispense- or  
 Community Medication Administration documents.

See the MHD Integration Profile of the ITI Technical Framework for a detailed description of  
 this transaction (ITI MHD: 3.65).

**4.1.2.9 Retrieve Document [ITI-68]**

545 This transaction is sent by a Medication Treatment Planner, Prescription Placer, Pharmaceutical  
 Adviser, Medication Dispenser or Medication Administration Performer Actor to a repository  
 actor (Medication Treatment Plan/Prescription/Pharmaceutical Advice/Dispensed  
 Medication/Administered Medication Repository) or the Community Pharmacy Manager Actor  
 in order to retrieve one or more Community Medication Treatment Plan-, Community  
 550 Prescription-, Community Pharmaceutical Advice-, Community Dispense- or Community  
 Medication Administration documents.

See the MHD Integration Profile of the ITI Technical Framework for a detailed description of  
 this transaction (ITI MHD: 3.68).

**4.2 CMPD Actor Options**

555 Options that may be selected for each actor in this profile, if any, are listed in Table 4.2-1.  
 Dependencies between options when applicable are specified in notes.

**Table 4.2-1: Community Medication Prescription and Dispense - Actors and Options**

Actor	Option Name	Reference
Community Pharmacy Manager <sup>3</sup>	Provision of Medication List	PHARM TF-1: 4.2.1

## IHE Pharmacy Technical Framework Supplement – Community Medication Prescription and Dispense (CMPD)

Actor	Option Name	Reference
	Persistence of Retrieved Documents <sup>1</sup>	PHARM TF-1: 4.2.2
	Medication Treatment Planning	PHARM TF-1: 4.2.3
	Query Pharmacy Documents over SOAP	PHARM TF-1:4.2.5
	Query Pharmacy Documents over MHD MHD XDS on FHIR <sup>2</sup>	PHARM TF-1: 4.2.6 ITI MHD: 33.2.2
Medication Treatment Planner <sup>3</sup>	Workflow Management	PHARM TF-1: 4.2.4
	Provision of Medication List	PHARM TF-1: 4.2.1
	Query Pharmacy Documents over SOAP	PHARM TF-1: 4.2.5
	Query Pharmacy Documents over MHD MHD Comprehensive Metadata <sup>2</sup>	PHARM TF-1: 4.2.6 ITI MHD: 33.2.1
Prescription Placer <sup>3</sup>	Workflow Management	PHARM TF-1: 4.2.4
	Provision of Medication List	PHARM TF-1: 4.2.1
	Medication Treatment Planning	PHARM TF-1: 4.2.3
	Query Pharmacy Documents over SOAP	PHARM TF-1: 4.2.5
	Query Pharmacy Documents over MHD MHD Comprehensive Metadata <sup>2</sup>	PHARM TF-1: 4.2.6 ITI MHD: 33.2.1
Pharmaceutical Adviser <sup>3</sup>	Workflow Management	PHARM TF-1: 4.2.4
	Provision of Medication List	PHARM TF-1: 4.2.1
	Medication Treatment Planning	PHARM TF-1: 4.2.3
	Query Pharmacy Documents over SOAP	PHARM TF-1: 4.2.5
	Query Pharmacy Documents over MHD MHD Comprehensive Metadata <sup>2</sup>	PHARM TF-1: 4.2.6 ITI MHD: 33.2.1
Medication Dispenser <sup>3</sup>	Workflow Management	PHARM TF-1: 4.2.4
	Provision of Medication List	PHARM TF-1: 4.2.1
	Medication Treatment Planning	PHARM TF-1: 4.2.3
	Query Pharmacy Documents over SOAP	PHARM TF-1: 4.2.5
	Query Pharmacy Documents over MHD MHD Comprehensive Metadata <sup>2</sup>	PHARM TF-1: 4.2.6 ITI MHD: 33.2.1
Medication Administration Performer <sup>3</sup>	Workflow Management	PHARM TF-1: 4.2.4
	Provision of Medication List	PHARM TF-1: 4.2.1
	Medication Treatment Planning	PHARM TF-1: 4.2.3
	Query Pharmacy Documents over SOAP	PHARM TF-1: 4.2.5
	Query Pharmacy Documents over MHD MHD Comprehensive Metadata <sup>2</sup>	PHARM TF-1: 4.2.6 ITI MHD: 33.2.1

Actor	Option Name	Reference
Repository Actor Medication Treatment Plan Prescription Pharmaceutical Advice Dispensed Medication Administered Medication Medication List	Query Pharmacy Documents over MHD MHD Comprehensive Metadata <sup>2</sup> MHD XDS on FHIR <sup>2</sup>	PHARM TF-1: 4.2.5 ITI MHD: 33.2.1 ITI MHD: 33.2.2

Notes:

1. Only applicable, if option “Provision of Medication List” is supported.
2. Required by “Query Pharmacy Documents over MHD” Option.
3. At least one of “Query Pharmacy Documents over SOAP” or “Query Pharmacy Documents over MHD” Options shall be selected.

560

#### 4.2.1 Provision of Medication List Option

A Community Pharmacy Manager implementing this option offers the ability to query for a Medication List and return an on-demand created version of the Medication List document. A Medication Treatment Planner-, Prescription Placer-, Pharmaceutical Adviser-, Medication Dispenser, Medication Administration Performer Actor implementing this option offers the ability to query for a Community Medication List and interpret its content according to the PML Profile. See use case described in Volume 1, Section 4.4.3.

565

#### 4.2.2 Persistence of Retrieved Documents Option

A Community Pharmacy Manager implementing this option offers the ability to persist the returned on-demand created version of the Community Medication List document when querying for a Medication List. This option requires the “Provision of Medication List” Option to be implemented. See use case described in Volume 1, Section 4.4.3 and ITI TF-1: 10.2.7.

570

#### 4.2.3 Medication Treatment Planning Option

A Community Pharmacy Manager implementing this option offers the ability to query for Medication Treatment Plans and to return the query result. A Medication Treatment Plan Placer-, Prescription Placer-, Pharmaceutical Adviser-, Medication Dispenser- or Medication Administration Performer implementing this option offers the ability to query for Medication Treatment Plans and interpret their content according to the MTP Profile. See use case described in Volume 1, Section 4.4.2.

575

580

#### **4.2.4 Workflow Management Option**

An actor implementing this option offers the ability to manage workflow according to the Workflow Definitions described in Volume 2, Section 4.

#### **585 4.2.5 Query Pharmacy Documents over SOAP Option**

A Community Pharmacy Manager implementing this option offers the ability to query for Pharmacy Documents using PHARM-1 and ITI-18 transactions and to retrieve Pharmacy Documents using ITI-43 transaction. A Medication Treatment Plan Placer-, Prescription Placer-, Pharmaceutical Adviser-, Medication Dispenser- or Medication Administration Performer  
590 implementing this option offers the ability to query for Pharmacy Documents using PHARM-1 and ITI-18 transactions, to retrieve Pharmacy Documents using ITI-43 transaction and to publish Pharmacy Documents using ITI-41 transaction.

At least one of Query Pharmacy Documents over SOAP Option or Query Pharmacy Documents over MHD Option shall be supported.

#### **595 4.2.6 Query Pharmacy Documents over MHD Option**

A Community Pharmacy Manager implementing this option offers the ability to query for Pharmacy Documents using PHARM-5, ITI-66 and ITI-67 transactions and to retrieve Pharmacy Documents using ITI-68 transaction. A Medication Treatment Plan Placer-, Prescription Placer-, Pharmaceutical Adviser-, Medication Dispenser- or Medication Administration Performer  
600 implementing this option offers the ability to query for Pharmacy Documents using PHARM-5, ITI-66 and ITI-67 transactions, to retrieve Pharmacy Documents using ITI-68 transaction and to publish Pharmacy Documents using ITI-65 transaction.

A Document Source implementing this option needs also to implement ITI MHD Comprehensive Metadata Option.

605 A Document Recipient implementing this option needs also to implement ITI MHD Comprehensive Metadata Option and ITI MHD XDS on FHIR Option.

A Document Responder implementing this option needs also to implement ITI MHD XDS on FHIR Option.

610 At least one of Query Pharmacy Documents over SOAP Option or Query Pharmacy Documents over MHD Option shall be supported.

### 4.3 CMPD Actor Groupings and Profile Interactions

**Table 4.3-1: CMPD Actor Groupings**

<b>CMPD Actor</b>	<b>Actor to be grouped with</b>	<b>Note</b>
Medication Treatment Planner	Content Creator: MTP Content Consumer: MTP, PRE, PADV, DIS, CMA, PML	The Medication Treatment Planner shall create Community Medication Treatment Plan documents according to the MTP Content Profile.
Prescription Placer	Content Creator: PRE Content Consumer: MTP, PRE, PADV, DIS, CMA, PML	The Prescription Placer shall create Community Prescription documents according to the PRE Content Profile.
Pharmaceutical Adviser	Content Creator: PADV Content Consumer: MTP, PRE, PADV, DIS, CMA, PML	The Pharmaceutical Adviser shall create Community Pharmaceutical Advice documents according to the PADV Content Profile.
Medication Dispenser	Content Creator: DIS Content Consumer: MTP, PRE, PADV, DIS, CMA, PML	The Medication Dispenser shall create Community Dispense documents according to the DIS Content Profile.
Medication Administration Performer	Content Creator: CMA Content Consumer: MTP, PRE, PADV, DIS, CMA, PML	The Medication Administration Performer shall create Community Medication Administration documents according to the CMA Content Profile.

Note: All five actors shall also be able to consume Community Medication Treatment Plan, Community Prescription, Community Pharmaceutical Advice, Community Dispense, and Community Medication Administration documents in order to determine the status of Prescription Items.

615

### 4.4 CMPD Process Flow

Current implementations of the community pharmacy process (plan, prescribe, dispense and administer medication) may be categorized in two different alternatives.

620 The first alternative is the so-called publish & pull. In this model, generally speaking, information is generated by a placer type actor (Medication Treatment Planner, Prescription Placer, Pharmaceutical Adviser, Medication Dispenser or Medication Administration Performer) and stored by means of a repository type actor. Other actors retrieve data by pulling it from repositories. This approach may apply to health systems where information is accessed on a  
625 centralized basis and, therefore, is made available to a collective of potential users (such as prescriptions available for dispense in any community pharmacy).

The alternative approach is the direct push model where information is sent directly to the actor intended to use it (e.g., prescriptions sent directly to the pharmacy named by the patient) and therefore no information is stored on a centralized basis. This model focuses on direct  
630 communication instead of availability to (more) potential users.

The current revision of the Integration Profile covers use cases relying on the publish & pull model only.

In order not to complexify the drawings and examples, the following sections are describing the use cases considering that the option “Query Pharmacy Documents over SOAP” is selected.  
635 However the same apply with the option “Query Pharmacy Documents over MHD”.

### ***Workflow scenarios***

The CMPD Process Flow can be principally differentiated in two basic workflow scenarios, one including a validation step by a Pharmaceutical Adviser and another excluding it:

- **Scenario 1: Including a validation step by a Pharmaceutical Adviser**
- 640 • **Scenario 2: Not including a validation step by a Pharmaceutical Adviser**

A domain using CMPD has to define in which workflow scenario it operates. If Workflow Scenario 2 is selected, it shall apply on all prescriptions, except those containing provisional Prescription Items for which Workflow Scenario 1 applies. If Scenario 1 is selected, it shall apply the same way to all prescriptions including prescriptions containing provisional  
645 Prescription Items.

Any software implementations of the CMPD Profile have to be able to operate in both workflow scenarios.

#### **4.4.1 Use Case community pharmacy-active substance, publish & pull (Scenario 1: “Including validation step, but not including planning and administration”)**

650 The purpose of this use case is to illustrate the prescription-dispense process in community pharmacy when the prescriber orders an active-substance (generic) medicine in the publish & pull model.

The process of this use case includes the validation step performed by a Pharmaceutical Adviser.

655 **Note:** The optional initial planning and the documentation of the administration of the medication would be eligible to be included in this scenario steps, but are not represented here in order to limit complexity. Inclusion of those two steps can be seen in the second scenario.

The following diagram shows the workflow of this use case and illustrates the overall context of

- ... (workflow) tasks
- Ordering, Validation, Dispensation
- 660 • ... which actor performs the task
- Prescription Placer, Pharmaceutical Adviser, Medication Dispenser
- ... the conditions leading to the next task

- In some cases depending on the outcome of the pharmaceutical validation documented in a Community Pharmaceutical Advice document (see PADV Profile)
- 665 • ... on which task-transition each query of transaction [PHARM-1] is used and which business rule it has to follow
  - FindPrescriptionsForValidation (by the Pharmaceutical Adviser)
  - FindPrescriptionsForDispense (by the Medication Dispenser)

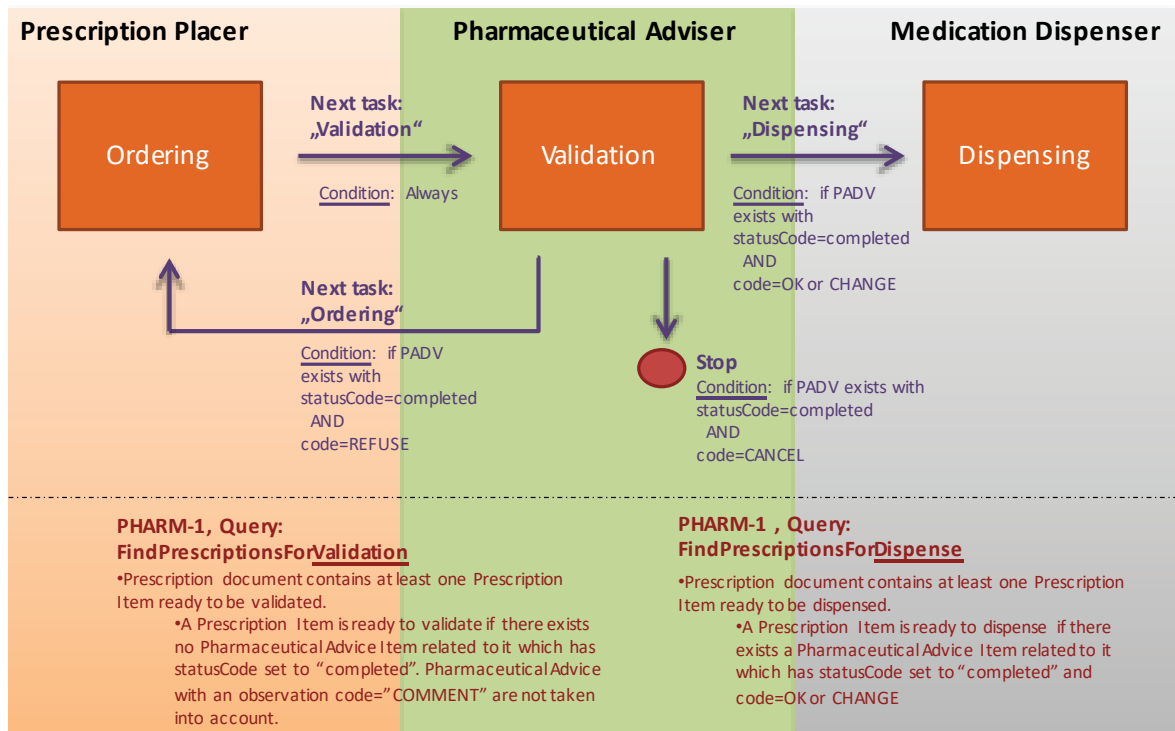

670

**Figure 4.4.1-1: Scenario 1: Overall context of the workflow**

This workflow is implicitly specified by the narrative descriptions in both this profile as well as in the Community Pharmaceutical Advice Profile.

- 675 Note that software implementations shall be able to perform it in any case, whether or not actors are grouped with option “Workflow Management” (grouping with that option does not change the actual workflow, it just allows “technical” workflow management).

Please refer to:

- Community Medication Prescription and Dispense (CMPD) Profile
  - Volume 2, Section 3.1.4.1.2.1.1.5 FindPrescriptionsForValidation



- 680
  - Volume 2, Section 3.1.4.1.2.1.1.6 FindPrescriptionsForDispense
  - In case of grouping with XDW: Volume 2, Section 4 Workflow Definitions
  - Community Pharmaceutical Advice (PADV) Profile
    - Vol. 2, Section 6.3.4.3.3.6 Status Code
    - Vol. 2, Section 6.3.4.3.3.4 Observation Code

#### 685 **4.4.1.1 Story Board**

John Doe attends a consultation to his general practitioner, GP, because he is experiencing some breathing difficulty. The practitioner examines John and prescribes the active substance “Fenoterol” in his “Prescription Placer” software. The prescription is electronically sent to the “Prescription Repository”.

690 Since prescriptions are available to a wide range of pharmacies, John picks the pharmacy closest to his office. The pharmacist asks for John’s health card in order to retrieve the patient’s active prescriptions. Since John also suffers from arthritis he has been prescribed Ibuprofen. The pharmacist checks for interactions and finds nothing outstanding. The information on the pharmaceutical advice is electronically sent to the “Pharmaceutical Advice Repository”.

695 He consults his inventory and picks Berotec® which is in the range of prices approved by the health system. He gives out this medicine to the patient and records the transaction in the “Medication Dispenser”. The information on the medication dispensed is electronically sent to the “Dispensed Medication Repository”.

#### **4.4.1.2 Sequence Diagram**

700 The following diagram represents the sequence of data exchanged between “system actors” involved in this use case.

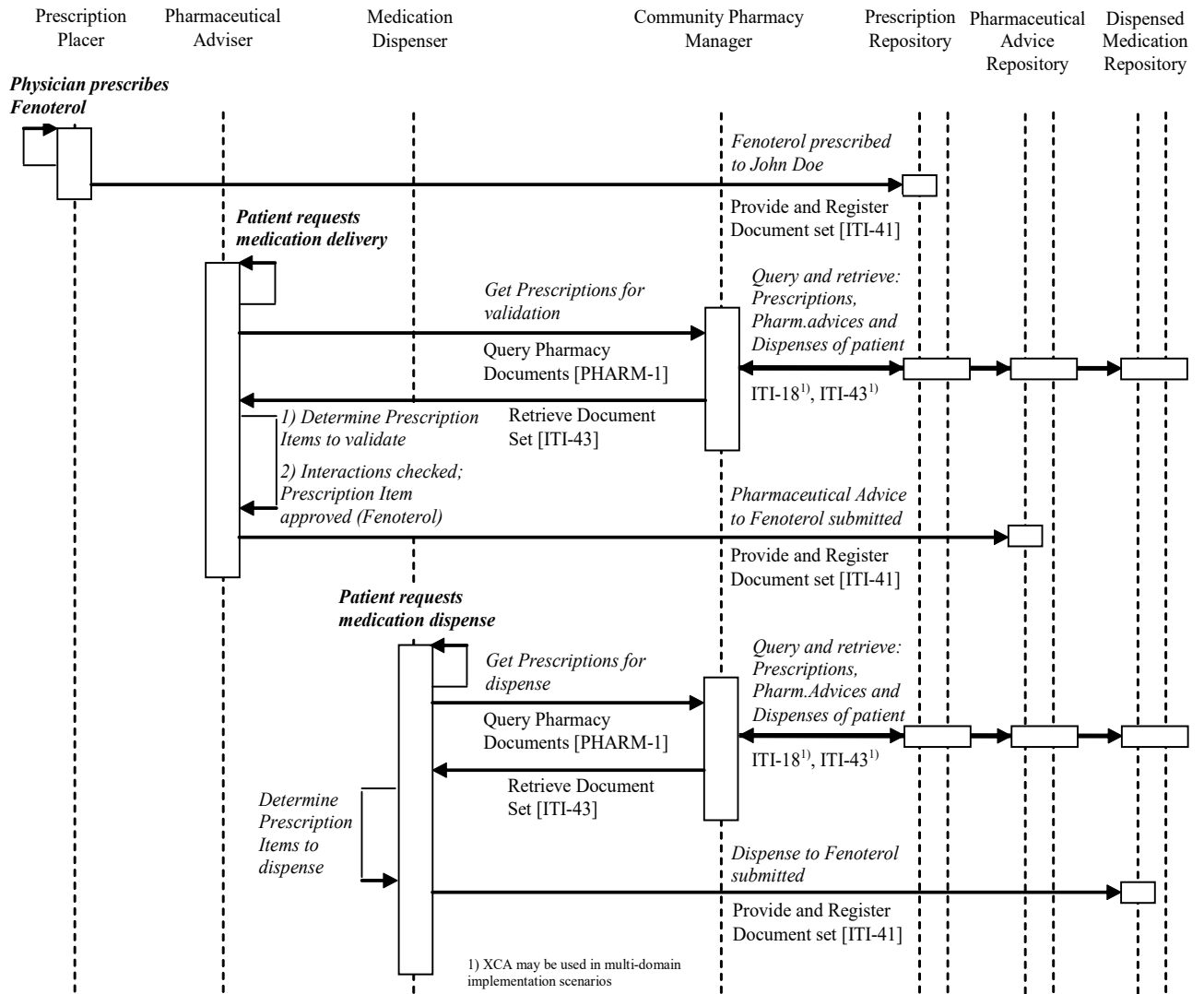

**Figure 4.4.1.2-1: Use Case community pharmacy-active substance, publish & pull - Process Flow (Scenario 1)**

705

This diagram illustrates the complete workflow of the prescription of a medication, the successful validation of the Prescription Item and the dispense of the medication (Scenario 1).

**4.4.2 Use Case community pharmacy-active substance, publish & pull (Scenario 2: “Including planning and administration, but not including validation step”)**

710

The purpose of this use case is to illustrate the planning-prescription-dispense-administration process in community pharmacy when the prescriber first plans an active substance (generic) medicine and then orders it in the publish & pull model.

The process of this use case does not include the validation step performed by a Pharmaceutical Adviser.

715 The following diagram shows the workflow of this use case and illustrates the overall context of

- ... (workflow) tasks
  - Planning, Ordering, Dispense, Administration
- ... which actor performs the task
  - Medication Treatment Planner, Prescription Placer, Medication Dispenser, Medication Administration Performer
- 720 • ... the conditions leading to the next task
- ... on which task-transition each query of transaction [PHARM-1] is used and which business rule it has to follow
  - FindMedicationTreatmentPlans (by the Prescription Placer)
  - 725 ○ FindPrescriptionsForDispense (by the Medication Dispenser)
  - FindDispenses (by the Medication Administration Performer)

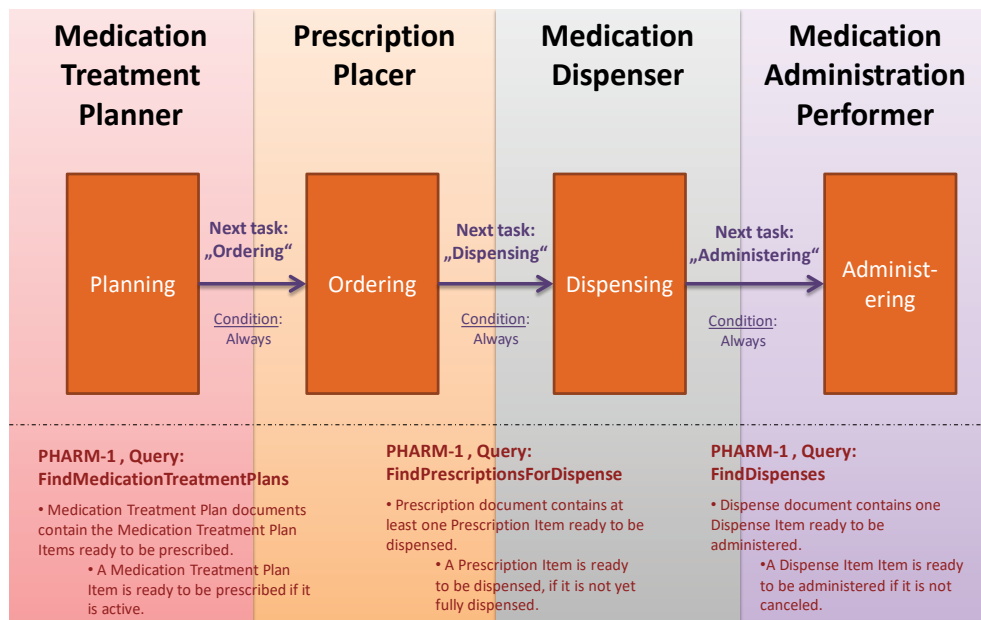

**Figure 4.4.2-1: Scenario 2: Overall context of the workflow**

730 This workflow is implicitly specified by the narrative descriptions in this profile.

Note that software implementations shall be able to perform it in any case, whether or not actors are grouped with option “Workflow Management” (grouping with that option does not change the actual workflow, it just allows “technical” workflow management).

Please refer to:

- 735       • Community Medication Prescription and Dispense (CMPD) Profile
  - Volume 2, Section 3.1.4.1.2.1.1.1 FindMedicationTreatmentPlans
  - Volume 2, Section 3.1.4.1.2.1.1.6 FindPrescriptionsForDispense
  - Volume 2, Section 3.1.4.1.2.1.1.3 FindDispenses
  - In case of grouping with XDW: Volume 2, Section 4 Workflow Definitions

#### 740       **4.4.2.1 Story Board**

John Doe attends a consultation to a physician, because he wants a treatment of his drug-addiction. The physician examines John and decides to add John to a drug-substitution program on Methadone. He adds “Methadone” to the planned medications in his “Medication Treatment Plan Planner” software. The new planned medication “Methadone” is electronically sent to the “Medication Treatment Plan Repository”.

745

As a prescription is required for getting this medication from the pharmacy, the physician also prescribes “10mg Methadone” as repeatable prescription in his “Prescription Placer” software. The prescription is electronically sent to the “Prescription Repository”.

Regulations according to the drug-substitution therapy require the medication to be taken by the patient directly in the dispensing pharmacy so that the pharmacist witnesses the intake and is able to electronically document the administration.

750

After the patient is entering the pharmacy and hands out the prescription to the pharmacist, the pharmacist dispenses the medication to the patient in a “ready-to-be-taken” form.

The patient drinks the Methadone solution in front of the pharmacist and the pharmacist documents the administration act in his “Medication Administration Performer” software. The documentation of the administration is electronically sent to the “Administered Medication Repository”.

755

#### **4.4.2.2 Sequence Diagram**

The following diagram represents the sequence of data exchanged between “system actors” involved in this use case.

760

# IHE Pharmacy Technical Framework Supplement – Community Medication Prescription and Dispense (CMPD)

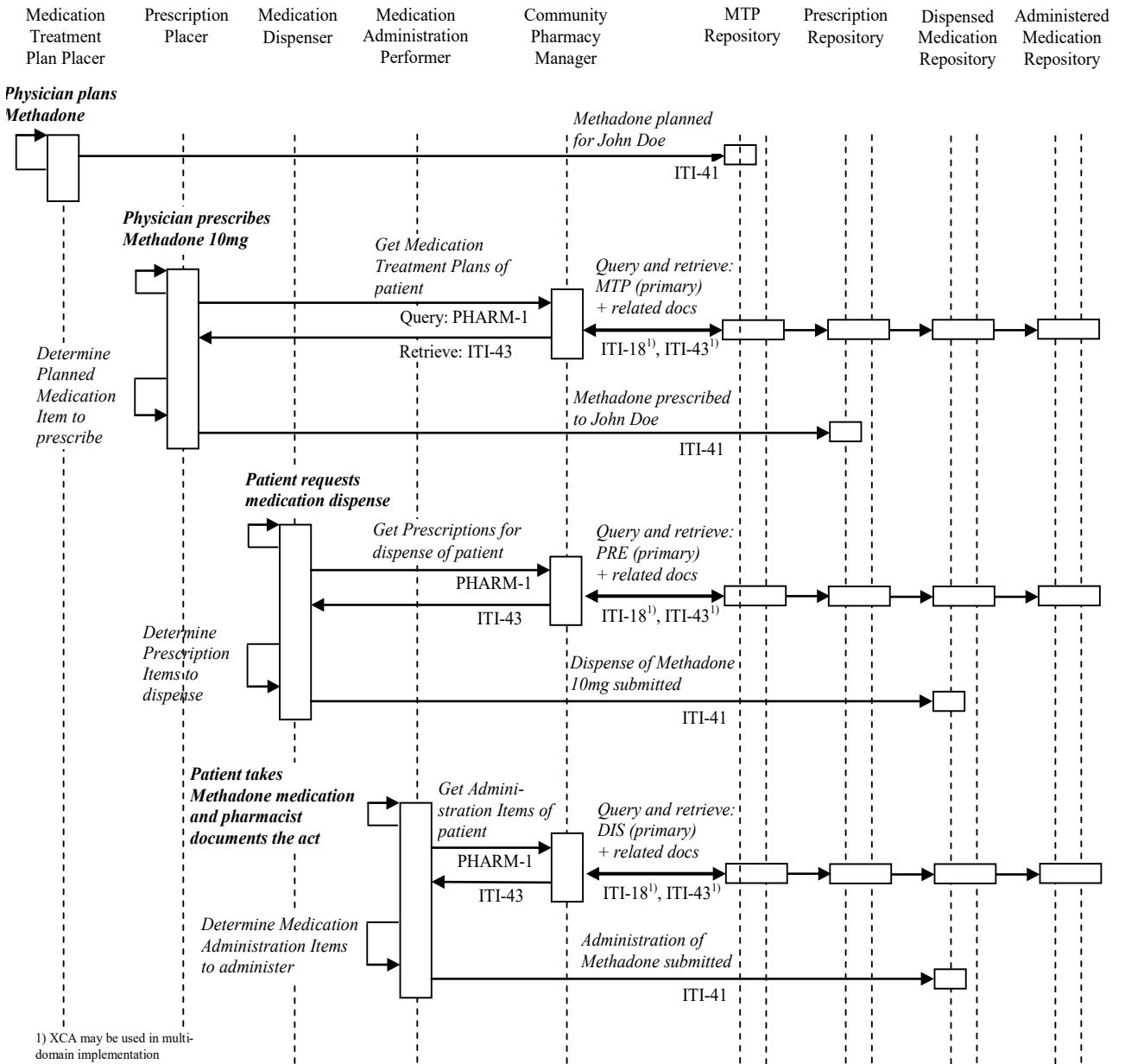

**Figure 4.4.2.2-1: Use Case community pharmacy-active substance, publish & pull - Process Flow (Scenario 2)**

765 This diagram illustrates the complete workflow of the planning, prescription, dispense and administration of the medication without validation (Scenario 2).

#### **4.4.3 Use Case: Physician requests Medication List**

770 The purpose of this use case is to illustrate the process of requesting the Medication List by a physician. This requires the support of the “Provision of Medication List” Option at the Community Pharmacy Manager.

##### **4.4.3.1 Story Board**

John Doe attends a consultation to his general practitioner, GP, because he is experiencing some breathing difficulty. The practitioner examines John and wants to prescribe the active substance “Fenoterol” in his “Prescription Placer” software.

775 To ensure that there are no conflicts between the new medication and the patient’s current medication status, the physician requests the Medication List.

The Prescription Placer uses transaction Query Pharmacy Document [PHARM-1] with query “FindMedicationList” to query the Medication List at the Community Pharmacy Manager.

780 The Community Pharmacy Manager queries the registry for the on-demand document entry of the Medication List to this patient. In case this query does not return a valid result, the Community Pharmacy Manager uses transaction “Register On-Demand Document” [ITI-61] to register the Community Medication List On-Demand Document. Either the found or just created Document Entry will be returned to the calling Prescription Placer.

785 The Prescription Placer now uses transaction “Retrieve Document Set” [ITI-43] to retrieve the actual Community Medication List Document from the Community Pharmacy Manager. The Community Pharmacy Manager uses ITI XDS transactions to query and retrieve Community Medication Treatment Plan-, Community Prescription-, Community Pharmaceutical Advice-, Community Dispense- and Community Medication Administration Documents from the repositories in order to assemble the Community Medication List Document. Once the document is assembled it returns the document to the calling Prescription Placer. If the “Persistence of Retrieved Documents” Option is used the returned document is also provided and registered in the registry/repository backend.

790

##### **4.4.3.2 Sequence Diagram**

795 The following diagram represents the sequence of data exchanged between “system actors” involved in this use case.

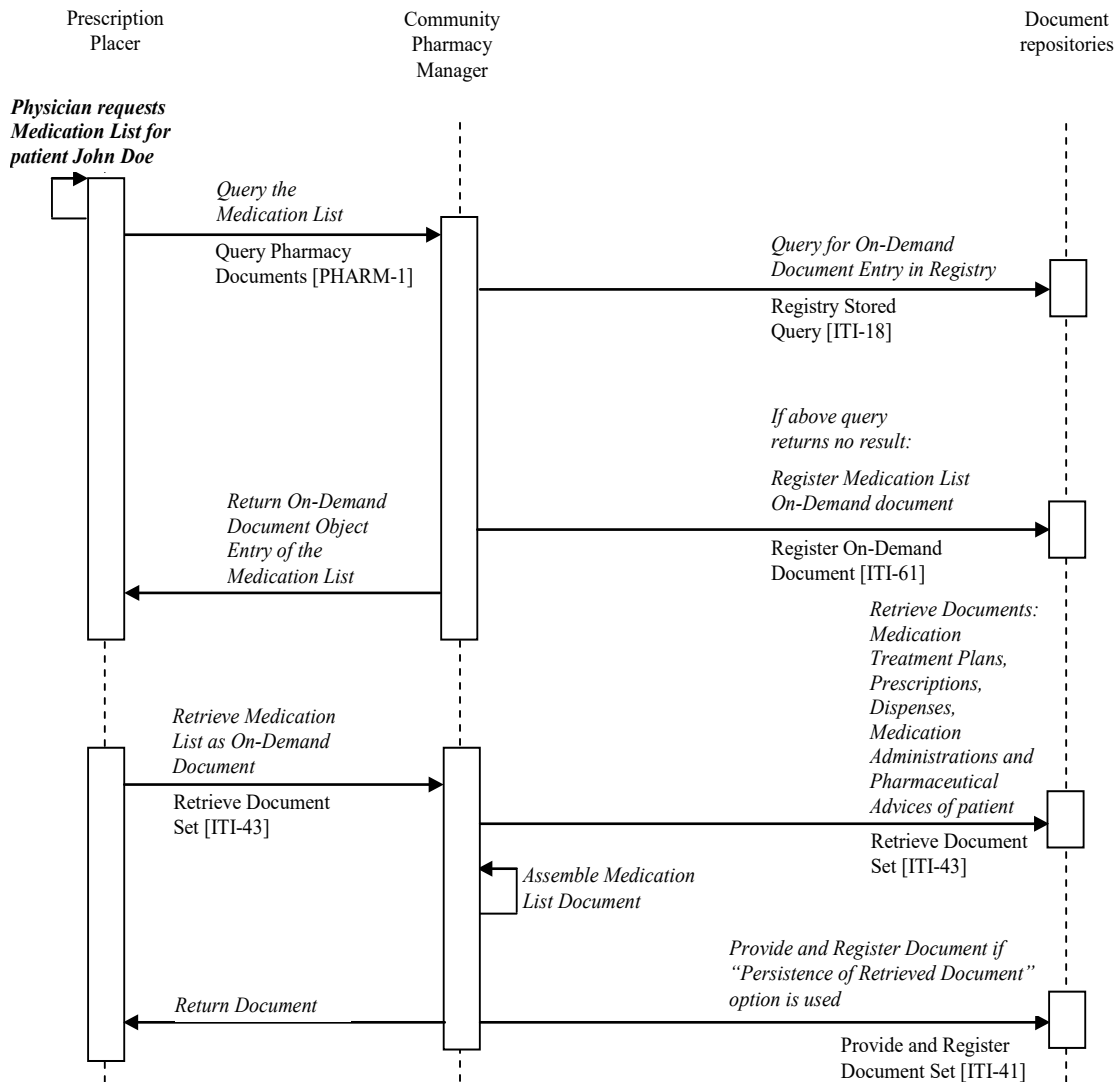

**Figure 4.4.3-1: Use Case Physician requests Medication List - Process Flow**

This diagram illustrates the complete workflow of the process of requesting the Medication List.

800 **4.4.4 Use Case: Physician changes/cancels or suspends an unfilled prescription**

The purpose of this use case is to illustrate the process of changing/canceling or suspending an unfilled prescription by a physician.

#### 4.4.4.1 Story Board

805 After getting Fenoterol prescribed by a physician, the patient John Doe, not having the medication dispensed by the pharmacy yet, re-visits the physician on the next day because the illness had improved. The patient has not yet received the prescribed medication at a pharmacy.

810 The physician performs another physical examination to confirm the improved health status and decides to amend the original prescription of Fenoterol by either *changing* it (e.g., to keep the medication, but with a lower dosage), *canceled* it (because it's not needed anymore) or *suspend* it (to observe the further course of the illness with the intention to decide later if the medication shall be given or canceled).

The physician issues a Community Pharmaceutical Advice document to record the command and instructs the patient.

#### 4.4.4.2 Sequence Diagram

815 The following diagram represents the sequence of data exchanged between “system actors” involved in this use case.

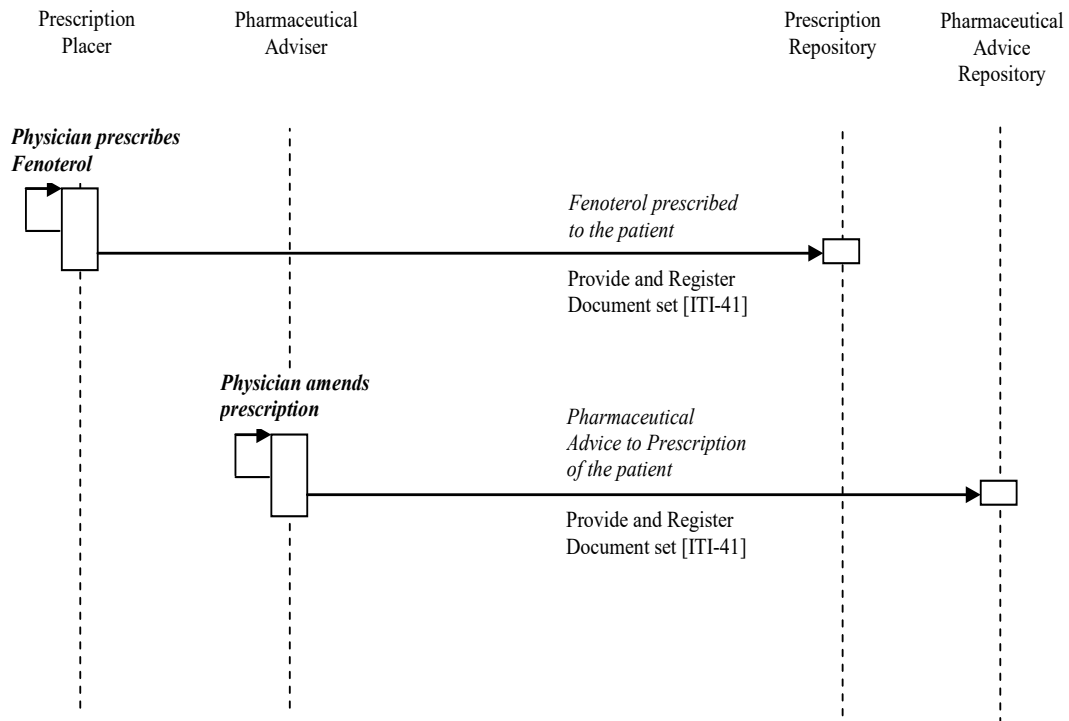

820 **Figure 4.4.4-1: Use Case: Physician changes/cancels or suspends an unfilled prescription**



#### **4.4.5 Use Case: Physician changes/stops or suspends the treatment with an already dispensed medication**

The purpose of this use case is to illustrate the process of changing/stopping or suspending the treatment with an already dispensed medication by a physician.

##### **825 4.4.5.1 Story Board**

After getting a prescription for Fenoterol by a physician, the patient John Doe has the medication dispensed by the pharmacy. The patient takes the medication for seven days. He then re-visits the physician because the illness had improved.

830 The physician performs another physical examination to confirm the improved health status and decides to amend the treatment with Fenoterol by either *changing* it (e.g., with a lower dosage), *stopping* it (because it's not needed anymore) or *suspending* it (e.g., to observe the further course of the illness with the intention to decide later if the medication shall be continued or stopped).<sup>6</sup>

The physician issues a Community Pharmaceutical Advice document to record the command and instructs the patient.

##### **835 4.4.5.2 Sequence Diagram**

The following diagram represents the sequence of data exchanged between “system actors” involved in this use case.

---

<sup>6</sup> Setting a medication treatment to suspend might also be used at admission of the patient into a hospital, because the hospital takes full control over the medication of the patient during the hospital stay. The original medication might be resumed at discharge of the patient.

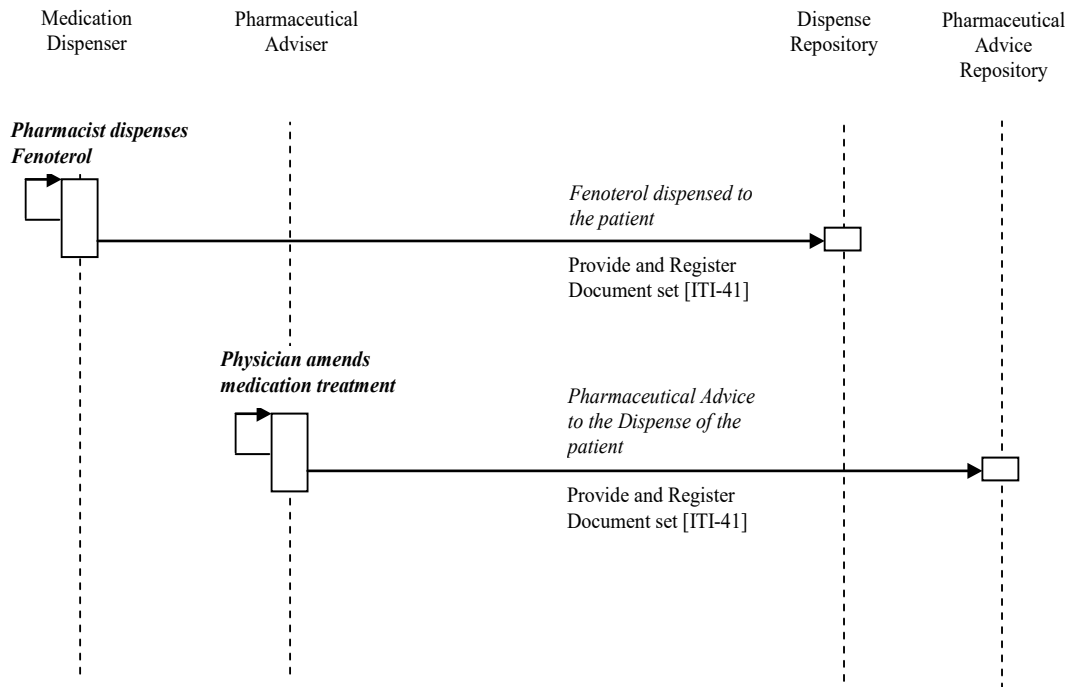

840 **Figure 4.4.5-1: Use Case: Physician changes/stops or suspends the treatment with an already dispensed medication**

**4.4.6 Use Case: Physician documents a medication-related issue after a chemotherapy medication was administered**

845 The purpose of this use case is to illustrate the process of documenting a medication-related issue to an administered chemotherapy medication.

**4.4.6.1 Story Board**

850 The patient John Doe is subject to a chemotherapy treatment. After getting a chemotherapy medication administered by a nurse and the administration act was fully documented, the patient goes home, but since he felt very bad, she returns to the outpatient department of the hospital and faints while waiting for her oncologist.

After arrival, the oncologist performs a physical examination and recognizes a potential relation of this issue to the just administered chemotherapy medication. The oncologist issues a Community Pharmaceutical Advice document related to the documented administration to document this potential medication-related issue.

855 **4.4.6.2 Sequence Diagram**

The following diagram represents the sequence of data exchanged between “system actors” involved in this use case.

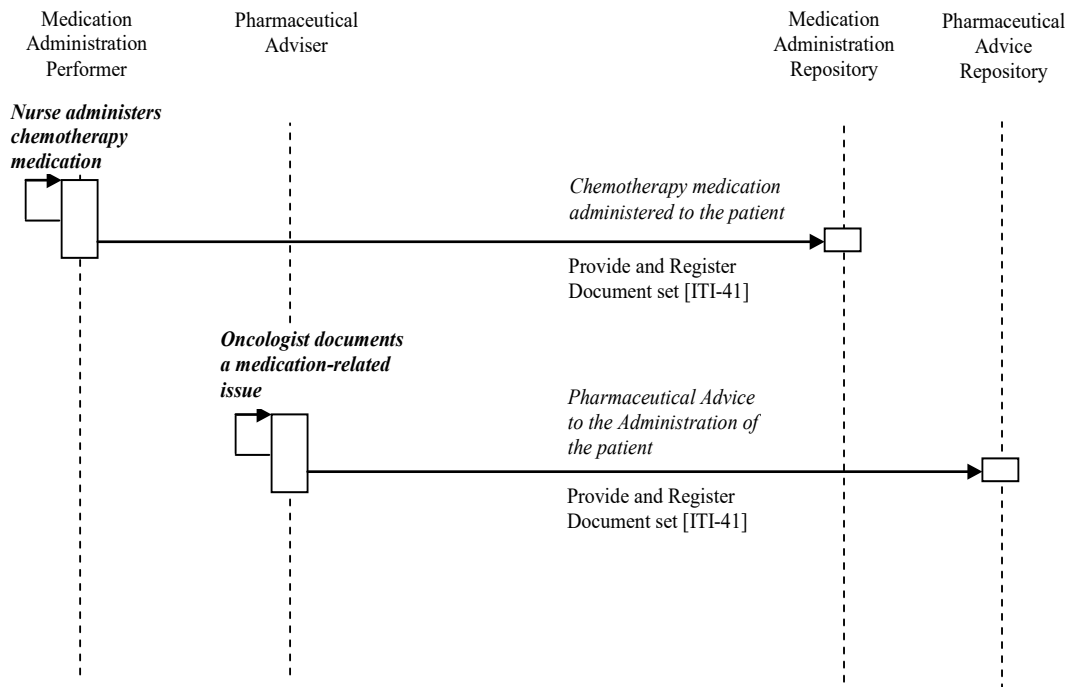

860 **Figure 4.4.6-1: Use Case: Physician documents a medication-related issue after a chemotherapy medication was administered**

## 4.5 CMPD Security Considerations

Relevant XDS Affinity Domain Security background is discussed in the XDS Security Considerations Section (see ITI TF-1: 10.7).

## 865 4.6 CMPD Implementation Scenarios

The following section describes several implementation scenarios for the Community Medication Prescription and Dispense Integration Profile.

870 The planning, prescription and dispense process of real-world projects involves several parties acting in the different abstract roles (Medication Treatment Planner, Prescription Placer, Pharmaceutical Adviser, Medication Dispenser, Medication Administration Performer). The Medication Treatment Planner and Prescription Placer roles are usually taken by physicians; the Pharmaceutical Adviser and Medication Dispenser role is usually taken by pharmacists; the Medication Administration Performer role may be taken by physicians or nurses, which all are usually organized in different organizations.

875 This results in a wide variety of implementation requirements together with the need of not only organizational but also technical separation of systems. Physicians may want to store plans,

880 prescriptions and administrations in another repository other than where pharmacists store dispenses or nurses store administrations. In a strict separation even the use of separate IHE affinity domains is required to arrange a throughout distinct scenario. CMPD was designed to be used in either *single-domain* or *multi-domain* scenarios to fit to these requirement.

Any political intended separation has to be technically bridged at one point otherwise a common planning, prescription and dispense process cannot be established. To minimize the possible points of contact between the domains the Community Pharmacy Manager was introduced.

Explanation to the diagrams used in the following implementation scenario sections:

- 885
- Dotted lines mean separation of concerns
  - Different background colors mean different XDS affinity domains

#### **4.6.1 Usage of CMPD in a “single-domain” scenario**

The descriptions of CMPD in the previous sections are aligned to the usage of the profile in a scenario where all actors are hosted in a *single XDS Affinity domain*.

890 Operating within a single XDS Affinity domain is the most simple implementation scenario and has several benefits, like e.g., that just one registry holds any document metadata, which eases query, retrieving and publishing of documents, etc.

895 On the other hand a simple scenario like this may not be applicable to scenarios in reality, where organizational, strategical or political reasons require more separation between the participating parties (physicians, pharmacists).

The following diagram shows a simple example of a single-domain implementation scenario to demonstrate the capabilities of CMPD.

Note: The “Administration” level (Medication Administration Performer) aligns with the principle as shown and is not included in this scenario in the interest of simplicity.

900

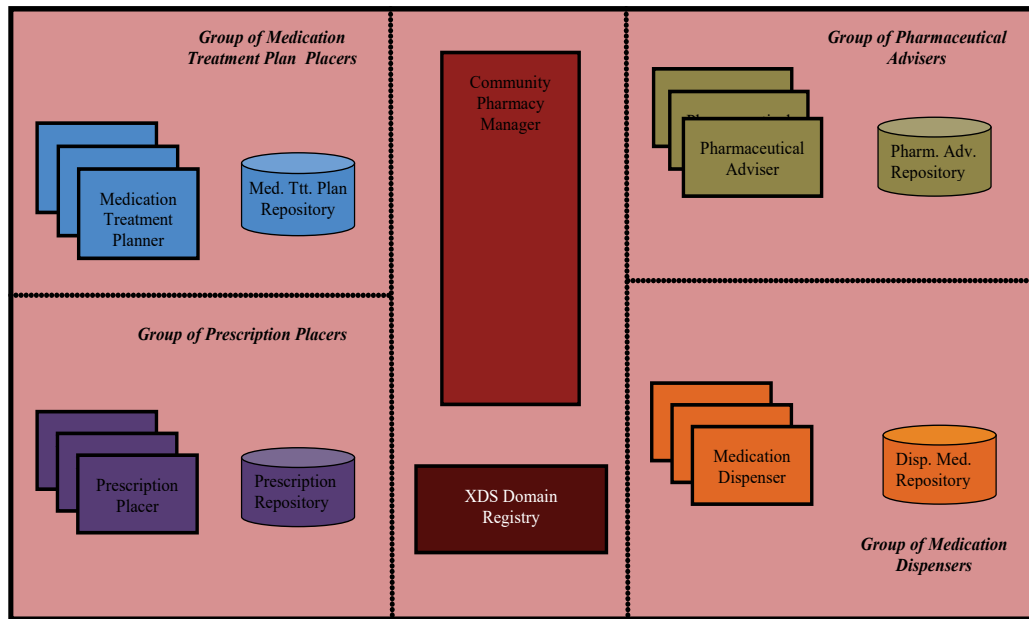

Description of the example scenario

905 The group of Medication Treatment Planners, Prescription Placers, Pharmaceutical Advisers and Medication Dispensers are altogether located in one XDS affinity domain. Each group stores its documents in its own dedicated repository, but all use the same document registry of the affinity domain.<sup>7</sup>

---

<sup>7</sup> In an even more simplified scenario the different document repositories could be merged into one single document repository, but this would not change the principles of the example.

---

910 **4.6.1.1 Demonstration of use case 1 in example scenario (simple)**

Step 1: Medication Treatment Planner creates a plan

The Medication Treatment Plan is submitted to the appropriate Medication Treatment Plan repository.

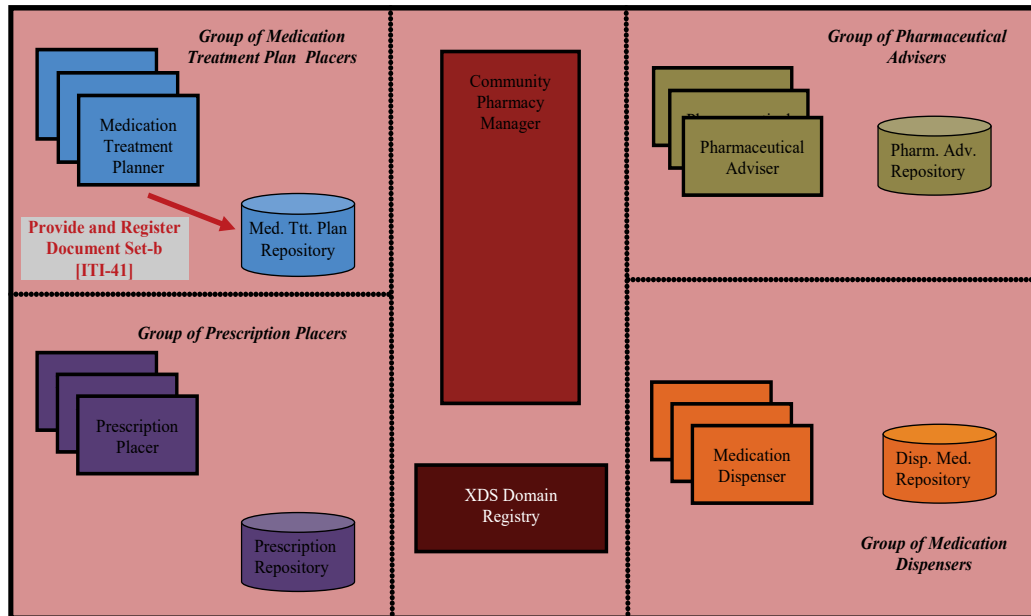

915

Step 2: Prescription Placer queries the plan

920 The Prescription Placer queries the plan by using transaction PHARM-1, query “**FindMedicationList**” in order to retrieve active Medication Treatment Plan Items.

The CPM queries the common XDS domain registry for Community Medication Treatment Plan- and Community Pharmaceutical Advice documents. Then it retrieves all these documents from the appropriate document repositories.

925 After retrieving it does linking of the documents by their document IDs and determines the status of each medication treatment plan. It applies appropriate filtering according to the semantic question “Ready for prescription” (i.e., “Active”) and returns just “relevant” document UUIDs to the Prescription Placer, which proceeds with step 3.

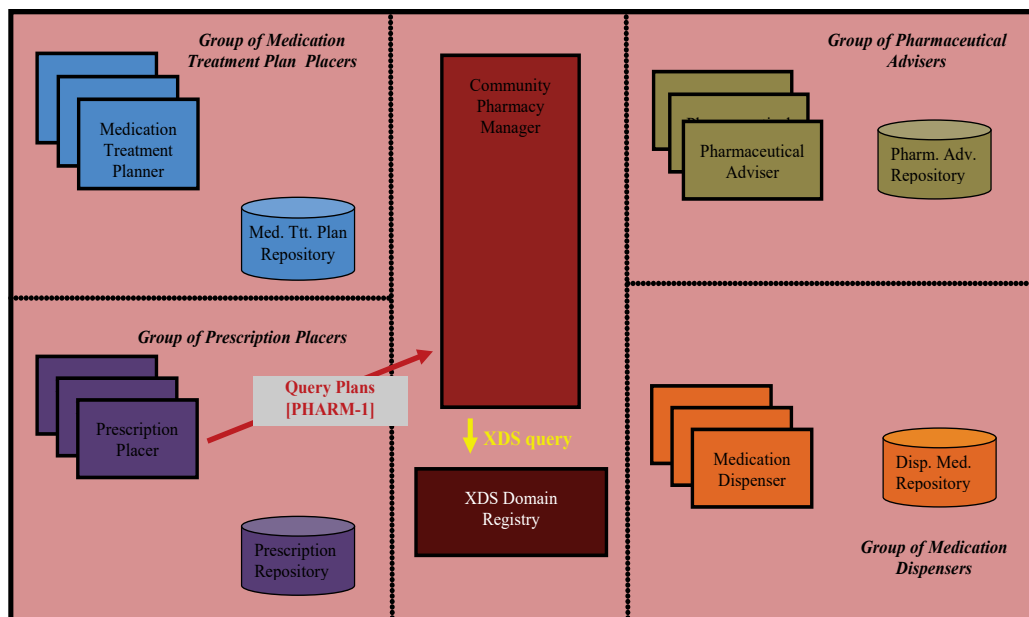

930

Step 3: Prescription Placer retrieves the documents of the query result

The Prescription Placer asks the CPM to retrieve all documents identified by the returned document UUIDs from the according document repositories.

- 935 The Prescription Placer (as a machine) parses and relinks the returned documents by their document IDs. Then the system or the human operator performs the selection of medication treatment plans to prescribe and proceeds with step 4.

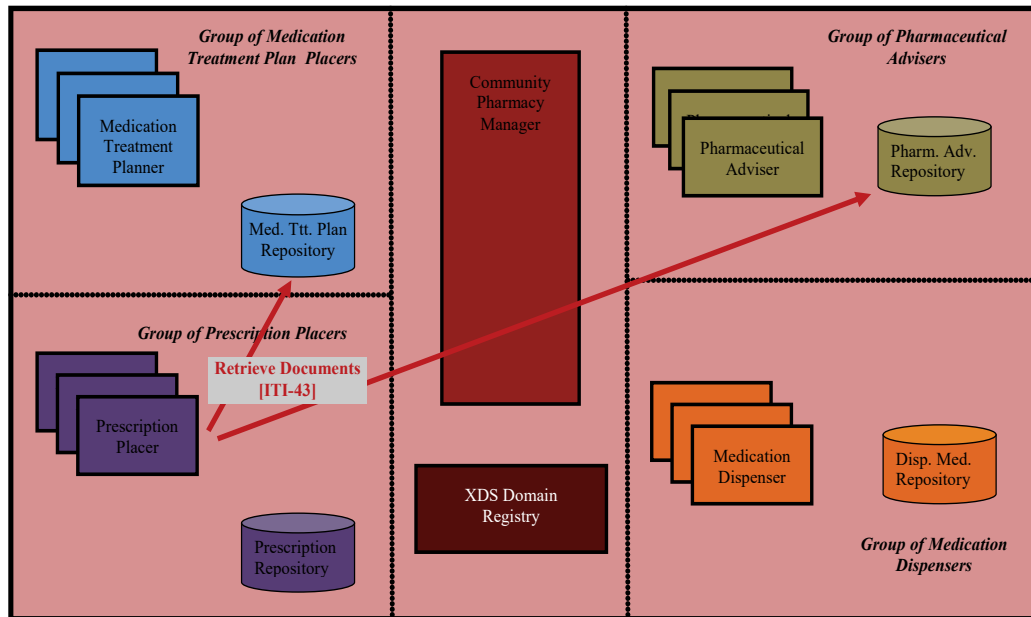

940



Step 4: Prescription Placer creates a prescription

The Community Prescription document is submitted to the appropriate Prescription Repository.

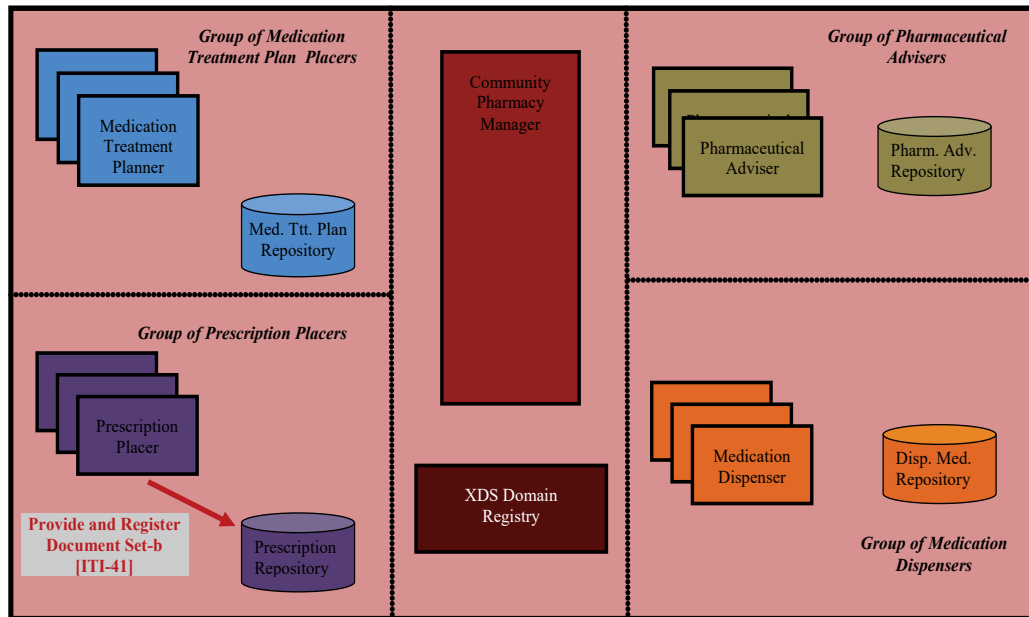

945

Step 5: Pharmaceutical Adviser queries the prescription

950 The Pharmaceutical Adviser queries the prescription by using transaction PHARM-1, query “**FindPrescriptionsForValidation**”.

The CPM queries the common XDS domain registry for prescription, pharmaceutical advice and dispense documents. Then it retrieves all these documents from the appropriate document repositories.

955 After retrieving it does linking of the documents by their document IDs and determines the status of each prescription. It applies appropriate filtering according to the semantic question “for Validation” and returns just “relevant” document UUIDs to the Pharmaceutical Adviser, which proceeds with step 6.

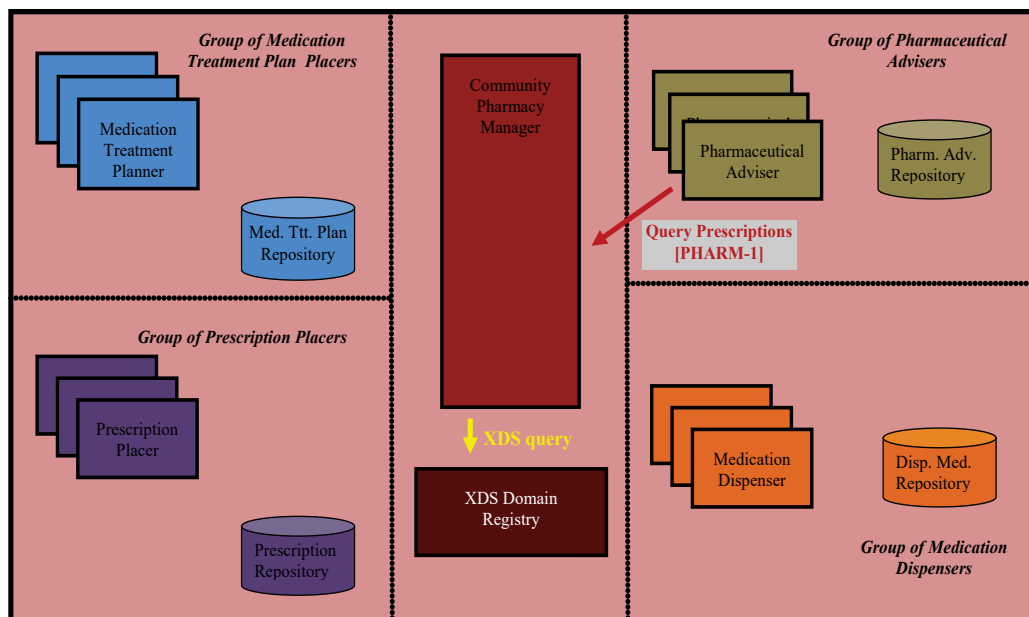

960

Step 6: Pharmaceutical Adviser retrieves the documents of the query result

The Pharmaceutical Adviser asks the CPM to retrieve all documents identified by the returned document UUIDs from the according document repositories.

965 The Pharmaceutical Adviser (as a machine) parses and relinks the returned documents by their document IDs. Then the system or the human operator performs validation and proceeds with step 7.

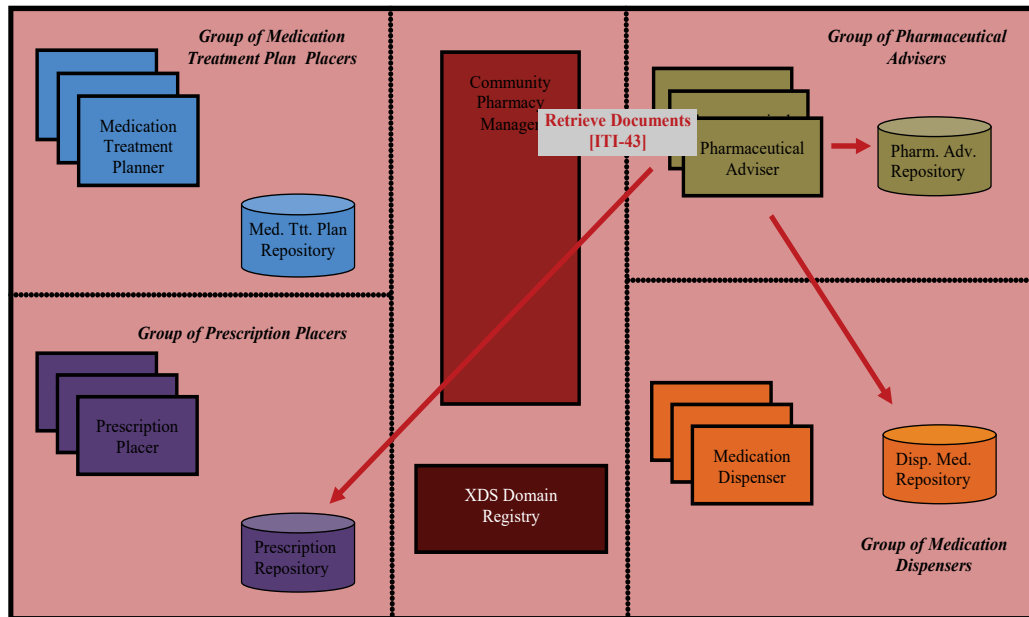

970

Step 7: Pharmaceutical Adviser submits a pharmaceutical advice

After the validation step the outcome of the validation is documented in a Community Pharmaceutical Advice document. This document is submitted to the appropriate Pharmaceutical Advice Repository.

975

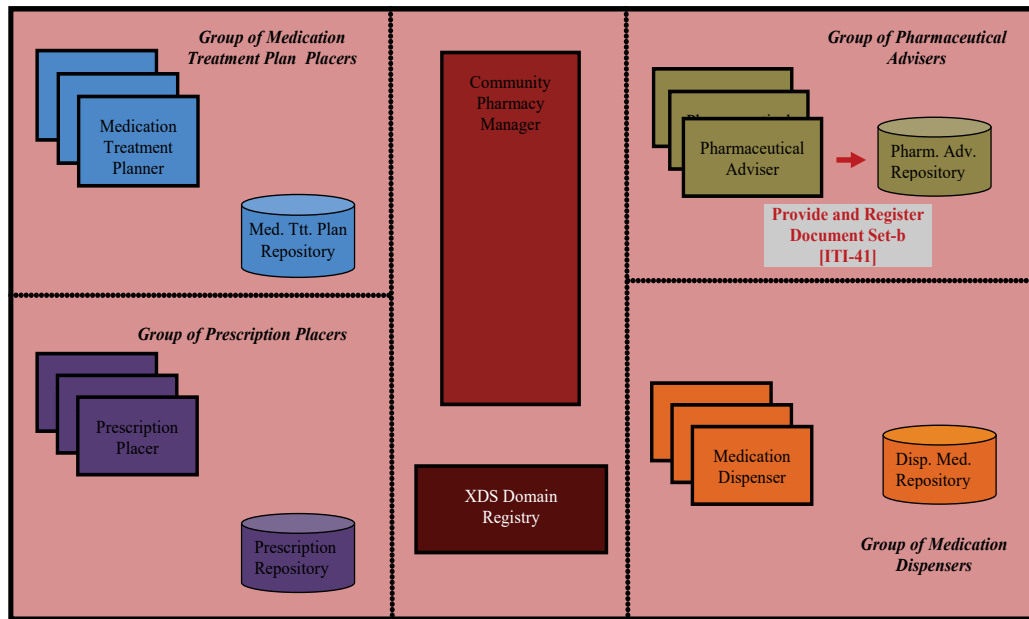

Step 8: Medication Dispenser queries the prescription

980 The Medication Dispenser queries the prescription by using transaction PHARM-1, query “**FindPrescriptionsForDispense**”.

Analog to step 5, the CPM queries the XDS domain registry for prescription, pharmaceutical advice and dispense documents. Then it retrieves all these documents from the appropriate document repositories.

985 After retrieving it performs linking of the documents by their document IDs and determines the status. It applies appropriate filtering according to the semantic question “for Dispense”, and returns just “relevant” document UUIDs to the Medication Dispenser, which proceeds with step 9.

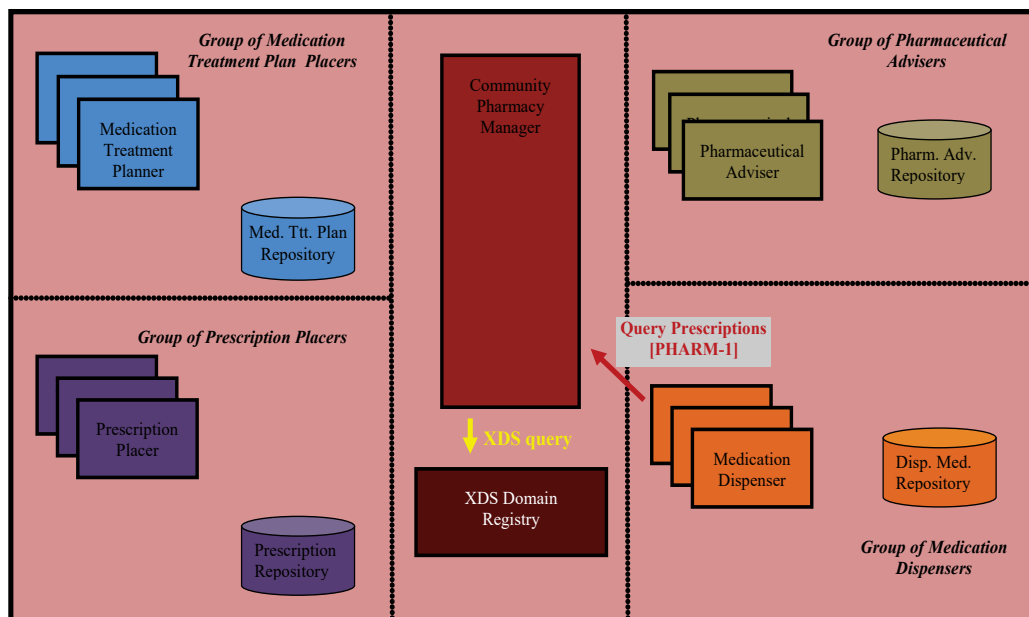

990

Step 9: Medication Dispenser retrieves the documents of the query result

The Medication Dispenser asks the CPM to retrieve all documents identified by the returned document UUIDs from the according document repositories.

995 The Medication Dispenser (as a machine) parses and relinks the returned documents by their document IDs. Then the human operator performs the dispense and proceeds with step 10.

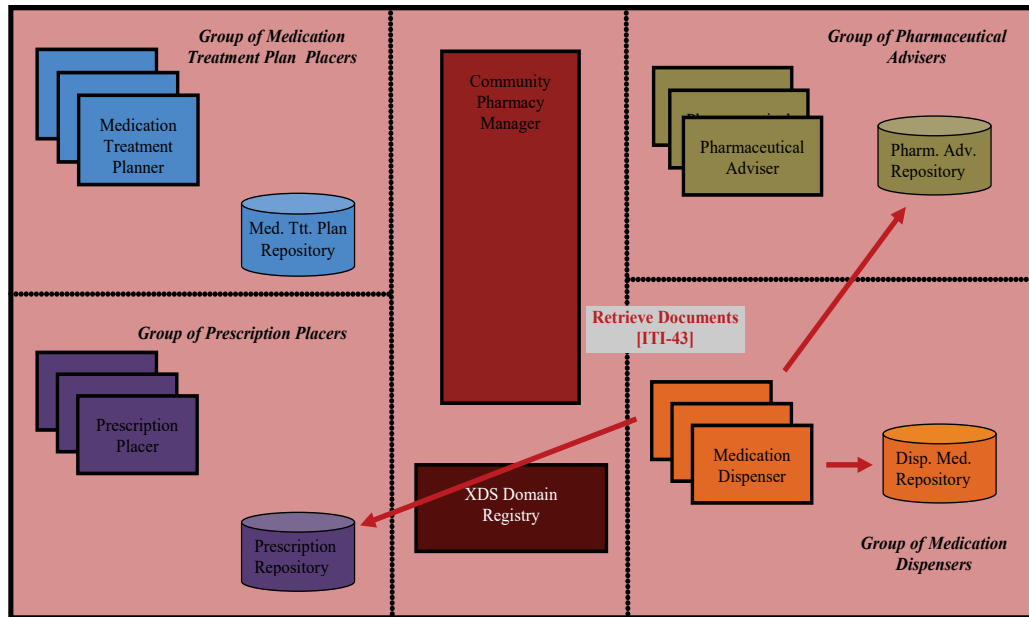

1000 Step 10: Medication Dispenser submits a dispense

After the dispense has taken place it is documented in a Community Dispense document. This document is submitted to the appropriate Dispensed Medication Repository.

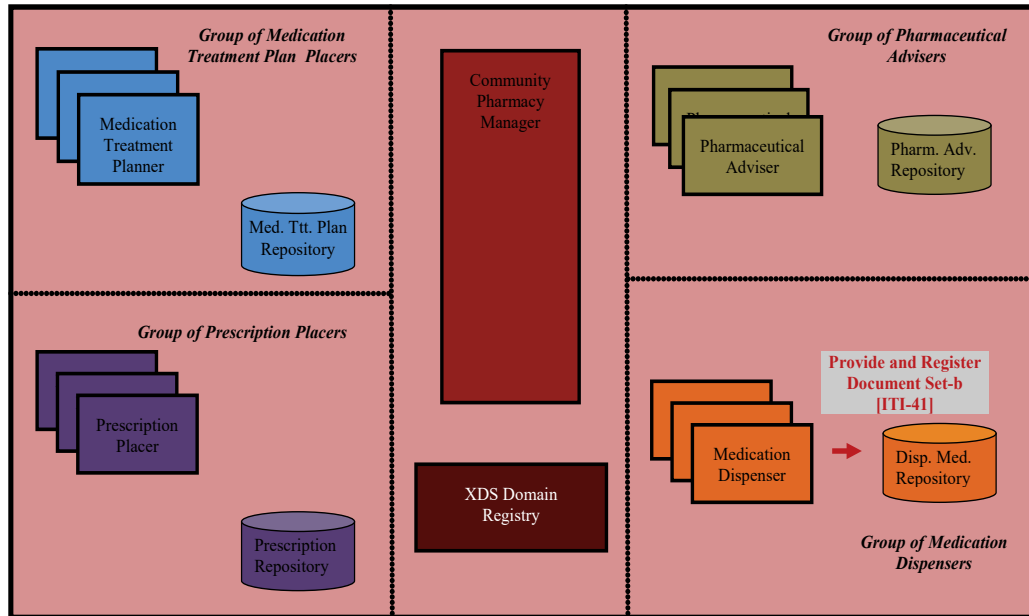

1005

#### 4.6.2 Usage of CMPD in a “multi-domain” scenario

The descriptions of CMPD in the previous sections are aligned to the usage of the profile in a scenario where all actors are hosted in a single XDS Affinity domain. Nevertheless the profile can also be used in *multi XDS Affinity domain* scenarios.

1010 Operating within a scenario consisting of multiple XDS Affinity domains is a complex but rather realistic implementation scenario. Its main benefit is that a minimum of technical contact is required between the participating parties of such a system (physicians, pharmacists) for achieving technical interoperability. Such utmost separation might be an organizational, strategic or political requirement.

1015 The following diagram shows an example of a possible multi-domain implementation scenario to demonstrate the capabilities of CMPD.

Note: The optional “Plan” level (Medication Treatment Planner) and the “Administration” level (Medication Administration Performer) align with the principle as shown and are not included in this scenario in the interest of simplicity.

1020

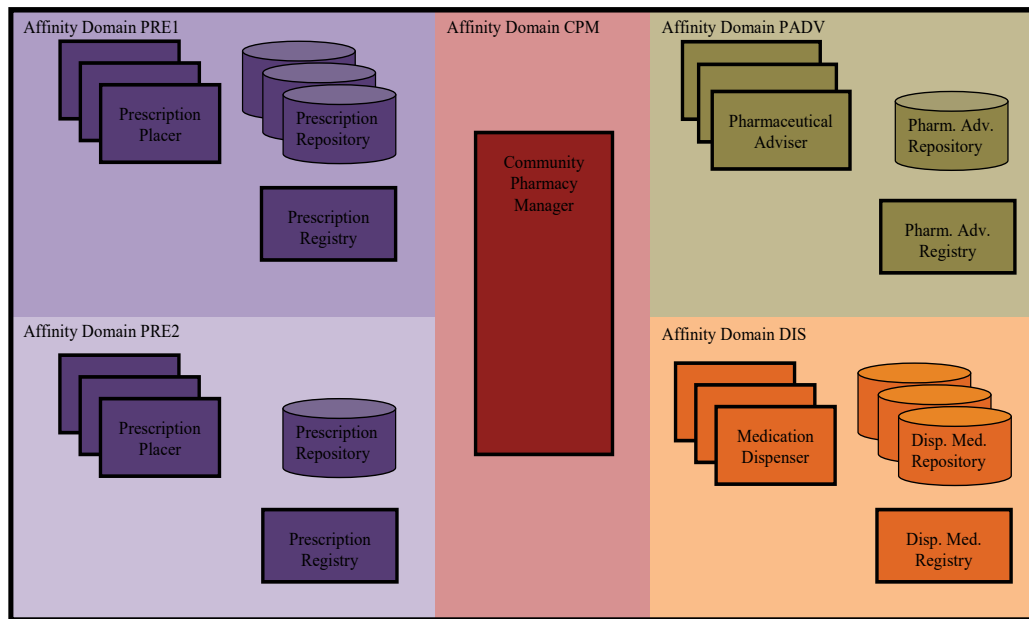

#### Description of the example scenario

1025 The group of Prescription Placers divides into 2 separate domains, the first (PRE1) showing a federated architecture with multiple repositories, the second (PRE2) with all clients connected to one.



The group of Pharmaceutical Advisers is organized in an own affinity domain (PADV), all storing in one repository.

1030 The group of Medication Dispensers are all organized in a common affinity domain (DIS), but everyone stores its dispenses in their own application (also acting as repository).

#### 4.6.2.1 Demonstration of use case 1 in example scenario (complex)

Step 1: Prescription Placer creates a prescription

1035 The Community Prescription document is submitted to the appropriate Prescription Repository.

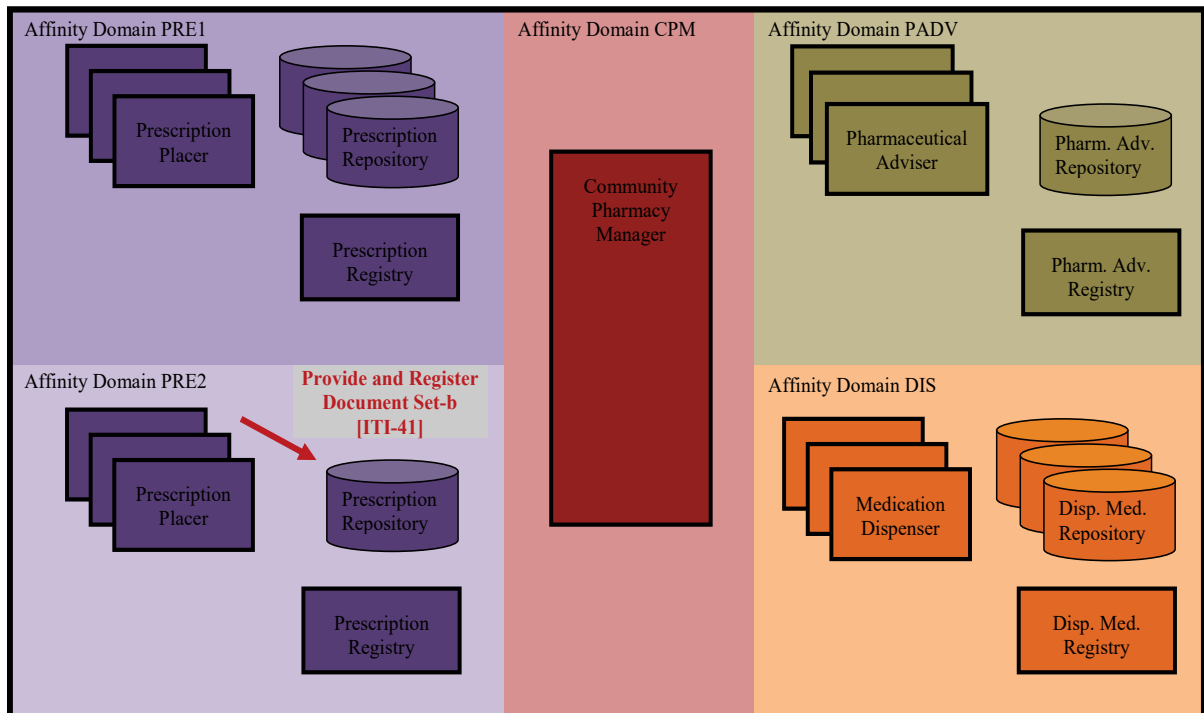

Step 2: Pharmaceutical Adviser queries the prescription

1040 The Pharmaceutical Adviser queries the prescription by using transaction PHARM-1, query “**FindPrescriptionsForValidation**”.

In this complex scenario the CPM has to use XCA mechanisms to query all other domains for prescription, pharmaceutical advice and dispense documents. Then it retrieves all these documents from the appropriate document repositories.

1045 After retrieving it does linking of the documents by their document IDs and determines the status of each prescription. It applies appropriate filtering according to the semantic question “for Validation” and returns just “relevant” document UUIDs to the Pharmaceutical Adviser, which proceeds with step 3.

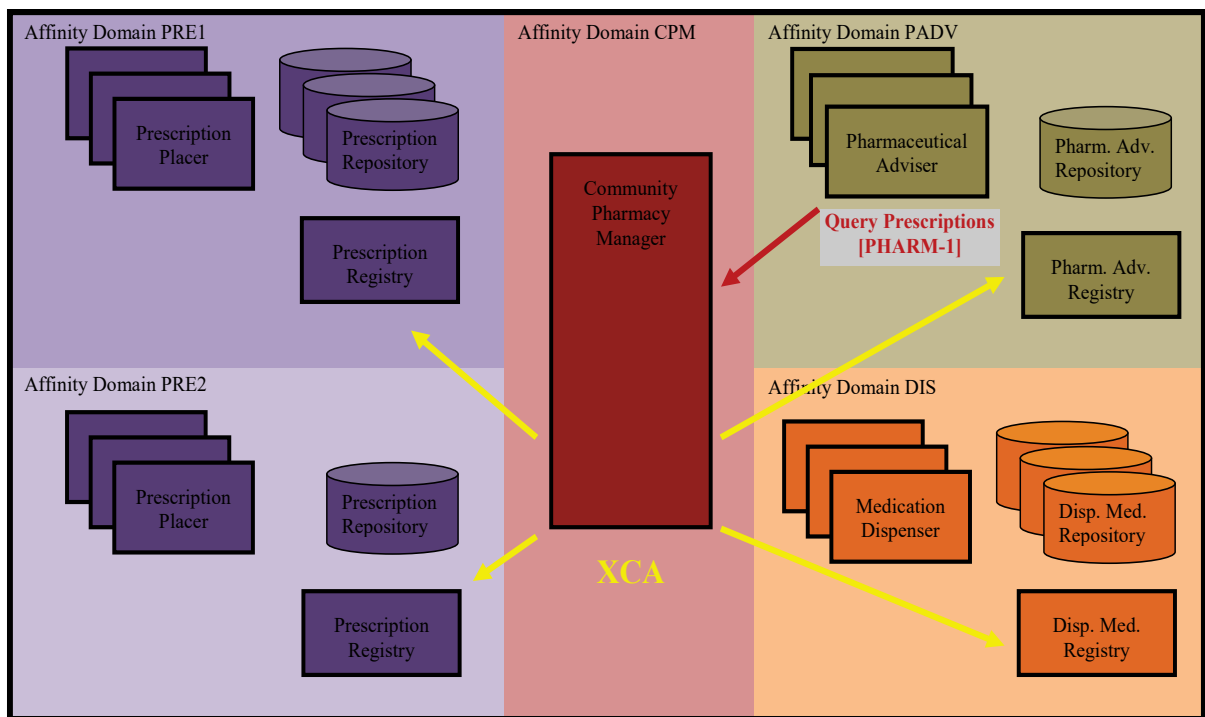

1050

Step 3: Pharmaceutical Adviser retrieves the documents of the query result

The Pharmaceutical Adviser retrieves all documents identified by the returned document UUIDs by XCA.

1055 The Pharmaceutical Adviser (as a machine) parses and relinks the returned documents by their document IDs. Then the system or the human operator performs validation and proceeds with step 4.

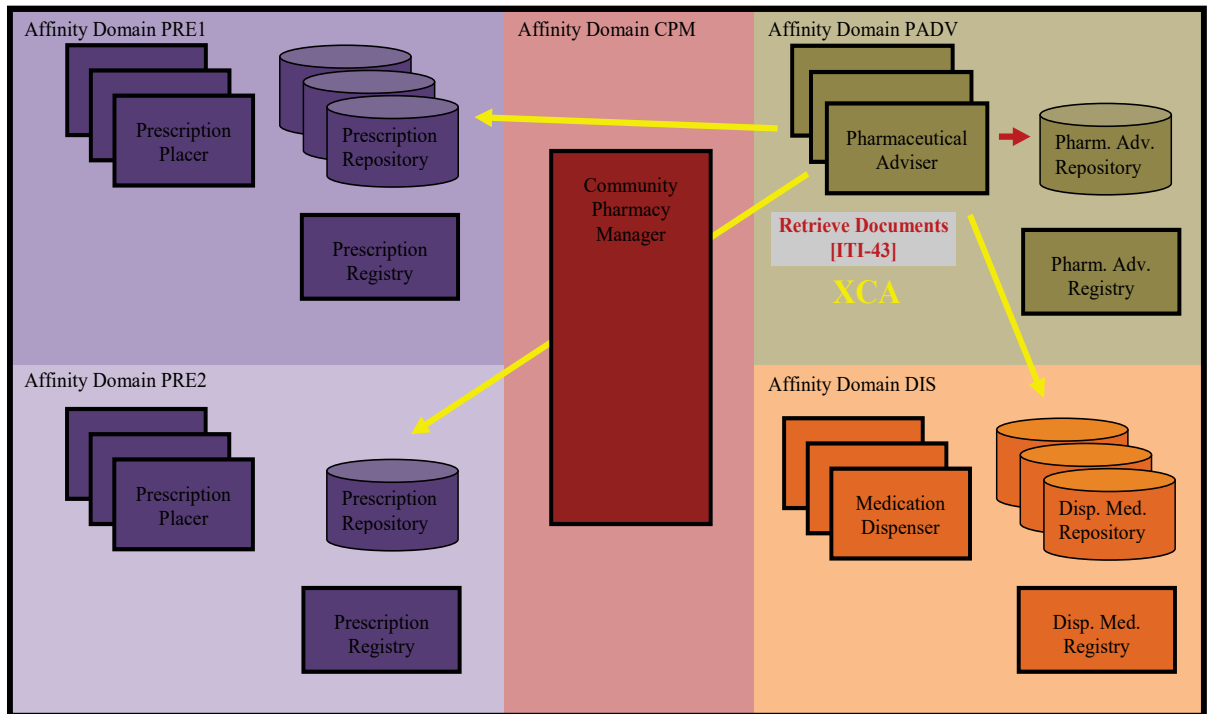

1060

Step 4: Pharmaceutical Adviser submits a pharmaceutical advice

After the validation step the outcome of the validation is documented in a Community Pharmaceutical Advice document. This document is submitted to the appropriate Pharmaceutical Advice Repository.

1065

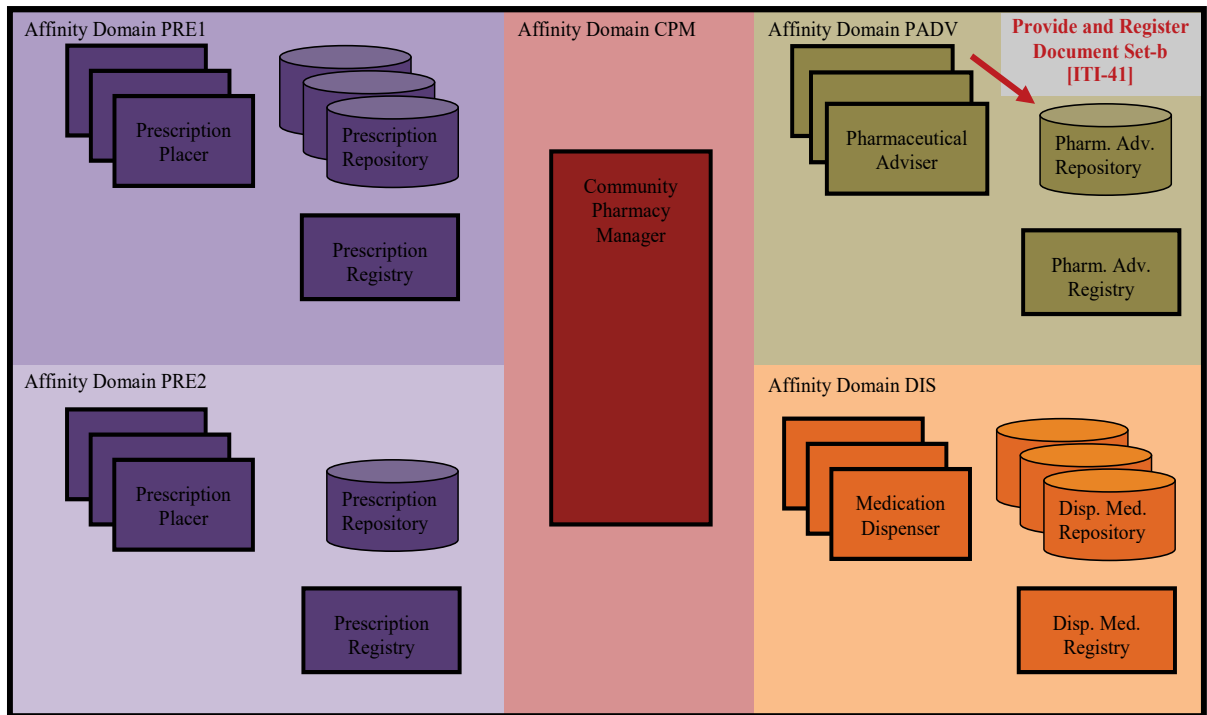

1070 Step 5: Medication Dispenser queries the prescription

The Medication Dispenser queries the prescription by using transaction PHARM-1, query “**FindPrescriptionsForDispense**”.

1075 Analog to step 2, the CPM uses XCA mechanisms to query all other domains for prescription, pharmaceutical advice and dispense documents. Then it retrieves all these documents from the appropriate document repositories.

After retrieving it performs linking of the documents by their document IDs and determines the status. It applies appropriate filtering according to the semantic question “for Dispense”, and returns just “relevant” document UUIDs to the Medication Dispenser, which proceeds with step 6.

1080

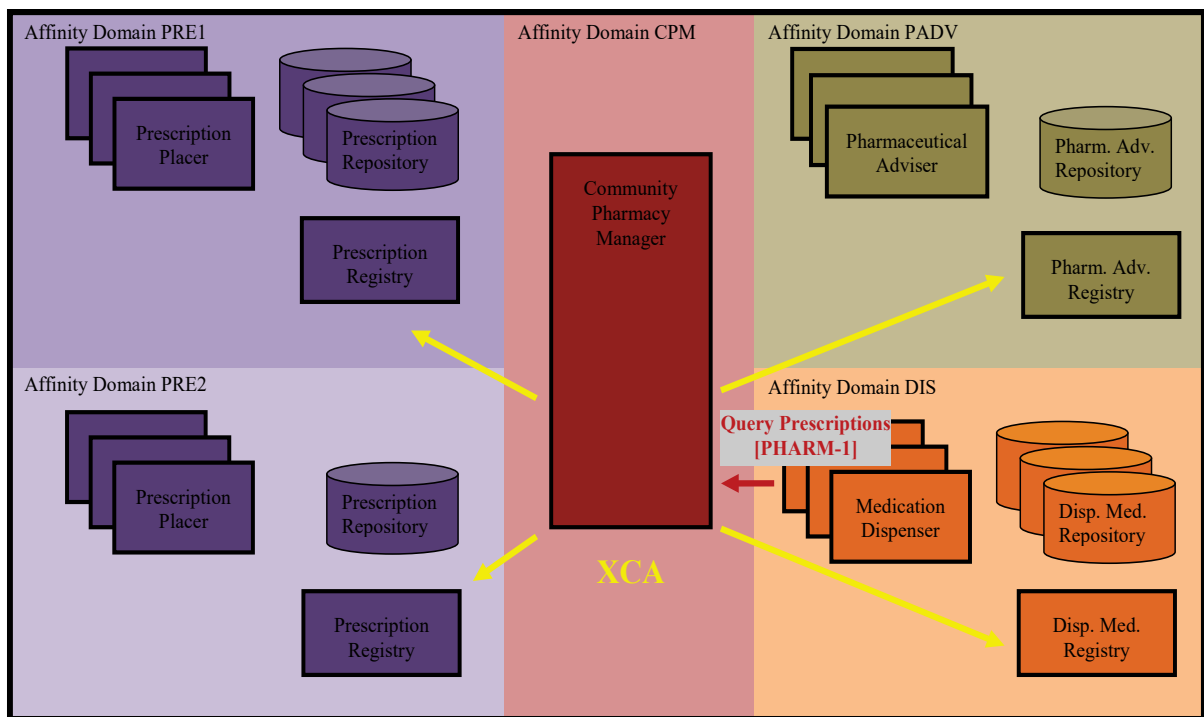

Step 6: Medication Dispenser retrieves the documents of the query result

1085 The Medication Dispenser retrieves all documents identified by the returned document UUIDs by XCA.

The Medication Dispenser (as a machine) parses and relinks the returned documents by their document IDs. Then the human operator performs the dispense and proceeds with step 7.

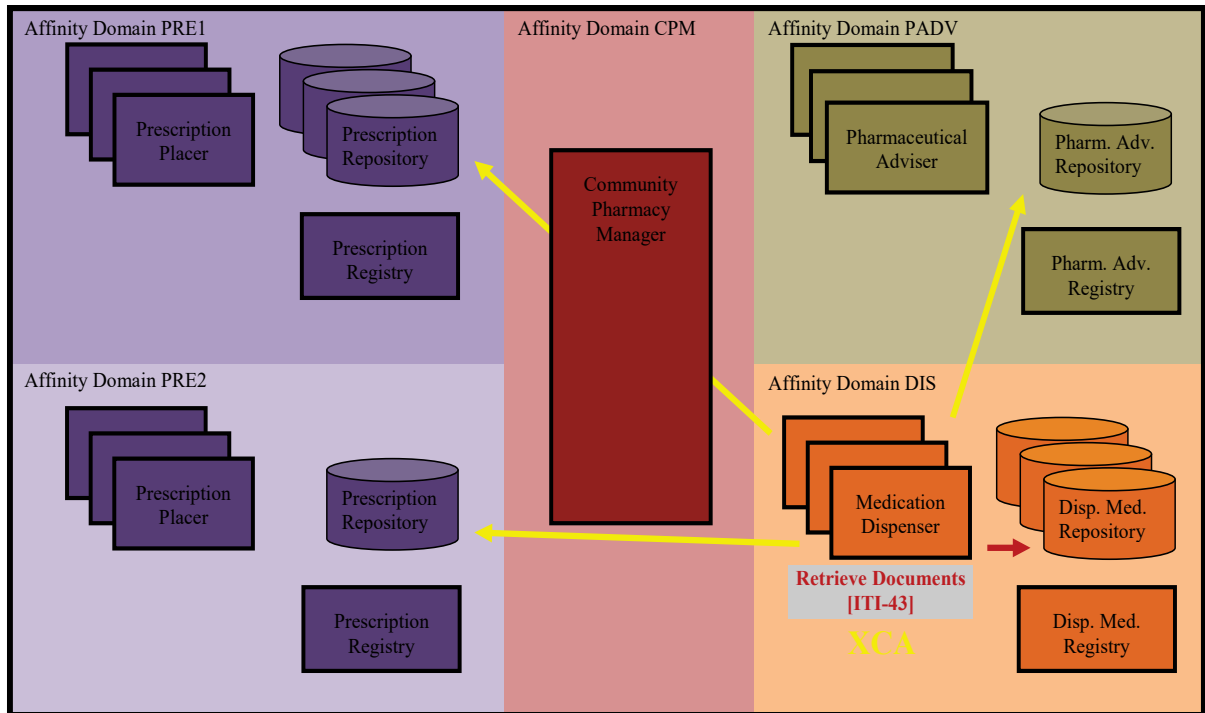

1090

Step 7: Medication Dispenser submits a dispense

1095 After the dispense has taken place it is documented in a Community Dispense document. This document is submitted to the appropriate Dispensed Medication Repository.

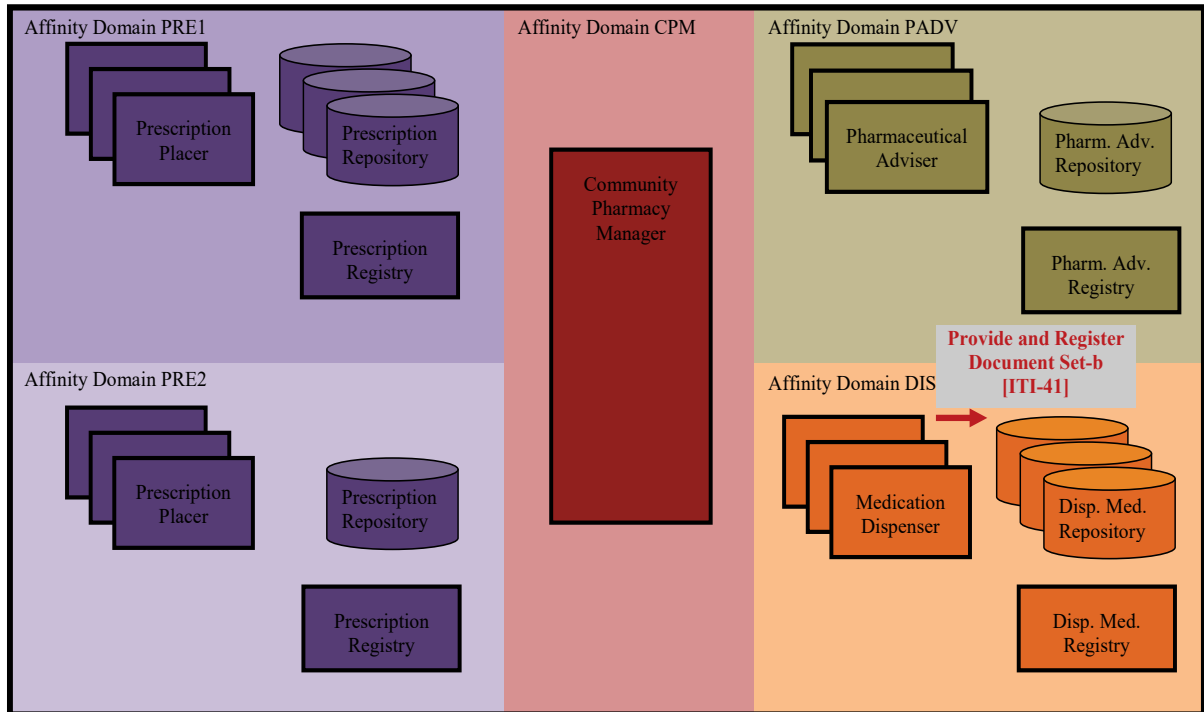



1100

## **Appendices to Volume 1**

None

## Volume 2 – Transactions

### 1105 3.0 IHE Transactions

*Add Section 3.1*

#### 3.1 Query Pharmacy Documents [PHARM-1]

1110 This transaction defines how a querying actor has to query the Community Pharmacy Manager for Community Medication Treatment Plans (MTP), Community Prescriptions (PRE), Community Dispenses (DIS) and Administrations (CMA) and their related documents. Related documents are mainly Community Pharmaceutical Advice (PADV) documents and possibly also Community Medication Treatment Plan (MTP), Community Dispense (DIS) and/or Administration (CMA) documents.

1115 Specialized queries allow the finding of prescriptions (and their related documents) for specific purposes (e.g., FindPrescriptionsForDispense).

Querying actors may be:

- Medication Treatment Planner
- Prescription Placer
- Pharmaceutical Adviser
- 1120 • Medication Dispenser
- Medication Administration Performer

1125 This transaction is very similar to the concept of the Registry Stored Query [ITI-18] transaction in the XDS Integration Profile of the ITI Technical Framework, except that the query itself targets not a single registry (like described in the XDS Integration Profile) but shall be able to sub-query one to many registry/repository systems (by using XCA in case of multi-domain scenarios) to get the requested query result.

The querying actor faces the same interface as if querying a XDS Document registry actor, although the query result may contain references to documents of many different domains.

##### 3.1.1 Scope

1130 The Query Pharmacy Documents transaction supports the following queries:

- **FindMedicationTreatmentPlans (if „Medication Treatment Planning“ Option is supported)**

Find planned medication documents and their related documents

- 1135
  - **FindPrescriptions**  
Find prescriptions and their related documents
  - **FindDispenses**  
Find dispense documents and their related documents
  - **FindMedicationAdministrations**  
Find administered medication documents and their related documents
- 1140
  - **FindPrescriptionsForValidation**  
Find prescriptions and their related documents containing Prescription Items ready to be validated
  - **FindPrescriptionsForDispense**  
Find prescriptions and their related documents containing Prescription Items ready to be dispensed
- 1145
  - **FindMedicationList (if “Provision of Medication List“ Option is supported)**  
Find the medication list to the patient

All queries return:

- Metadata for one or more registry objects, or
- 1150 • Object references for one or more registry objects (registry UUIDs).

### 3.1.2 Use Case Roles

The first diagram describes the use case when the Planner belongs to the same XDS Community than the Community Pharmacy Manager.

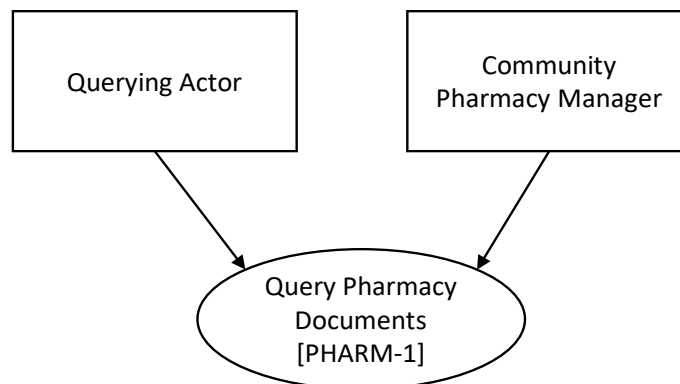

1155 **Actors:** Querying actor

**Role:** Requests a query by identifier (UUID), and passes parameters to the query. A parameter controlling the format of the returned data is passed; it selects either object references or full objects.

**Actor:** Community Pharmacy Manager

1160 **Role:** Services the query using its stored definitions of the queries defined for CMPD

The second diagram describes the use case when the Planner belongs to another XDS Community that the Community Pharmacy Manager. The general use case is represented; however it may also occur that a Community Pharmacy Manager has to forward the request to another Community Pharmacy Manager: in this situation, the first Community Pharmacy Manager will simply be grouped with the Planner actors and communication occurs through an XCA Initiating Gateway and an XCA Responding Gateway. If needed, the XCA Initiating gateway may perform some transformation of the request like patient identifier mapping.

1165

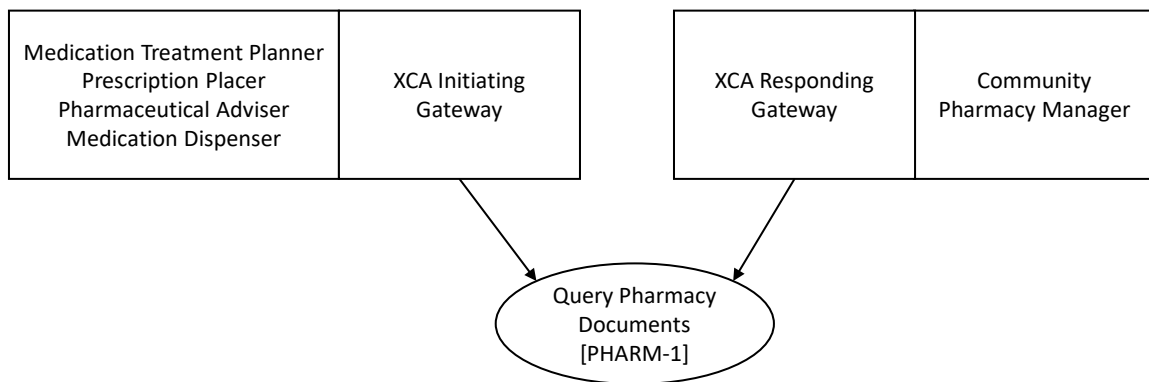

1170 **Actor:** Querying actors: Medication Treatment Planner, Prescription Placer, Pharmaceutical Adviser, Medication Dispenser, Medication Administration Performer grouped with an XCA Initiating Gateway

**Role:** Requests a query by identifier (UUID) and passes parameters to the query. A parameter controlling the format of the returned data is passed; it selects either object references or full objects.

1175

**Actor:** XCA Responding Gateway grouped with a Community Pharmacy Manager

**Role:** Services the query using its stored definitions of the queries defined for CMPD

### 3.1.3 Referenced Standard

ITI-18: Registry Stored Query and all its related standards.

### 1180 3.1.4 Messages

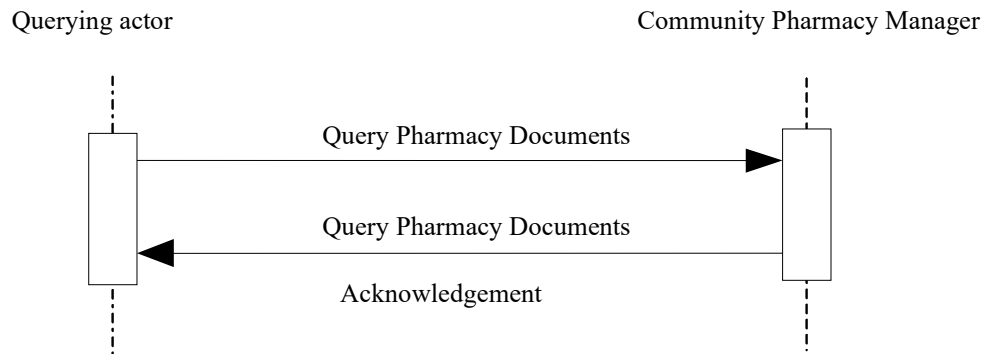

**Figure 3.1.4-1: Interaction Diagram**

#### 3.1.4.1 Query Pharmacy Documents

1185 This is a query request to the Community Pharmacy Manager from a Querying actor. The query request contains:

- A reference to a pre-defined query stored on the Document Registry.
- Parameters to the query. The query parameters are matched up with the query variables defined in the query definition on the Document Registry.

##### 3.1.4.1.1 Trigger Events

1190 This message is initiated when the Querying actor wants to query/retrieve document metadata.

This may be the case, if:

1. A Medication Treatment Planner, Prescription Placer, Pharmaceutical Adviser, Medication Dispenser or Medication Administration Performer wants to find medication treatment plans, prescriptions, dispenses or administrations (and their related pharmaceutical advices and possibly Community Medication Treatment Plan-,  
1195 Community Prescription-, Community Dispense- and/or administration documents).
2. A Pharmaceutical Adviser wants to find active prescriptions (and their related pharmaceutical advices and possibly Community Medication Treatment Plan-,  
1200 Community Dispense- and/or administration documents) ready to validate (Specialized query “FindPrescriptionsForValidation”).

- 1205
3. A Medication Dispenser wants to find active prescriptions (and their related pharmaceutical advices and possibly Community Medication Treatment Plan-, Community Dispense- and/or administration documents) which are already validated or ready for dispense (Specialized query “FindPrescriptionsForDispense”)
  4. A Medication Treatment Planner, Prescription Placer, Pharmaceutical Adviser or Medication Dispenser wants to find the Medication List to the patient (query “FindMedicationList”)

#### 3.1.4.1.2 Message Semantics

1210 The message semantics of this message are based on the definitions of the [ITI-18] transaction, but incorporate some important changes defined in the sections below.

References to: ITI TF-2: 3.18

##### 3.1.4.1.2.1 Required Queries

The Registry Stored Query [ITI-18] transaction defines several kinds of Stored Queries (FindDocuments, FindSubmissionSets, etc.).

1215 The [PHARM-1] transaction is alike to this concept but provides a different set of Stored Queries.

The provided Stored Queries are:

- **FindMedicationTreatmentPlans (if “Medication Treatment Planning” Option is supported)**  
1220 Find planned medication documents and their related documents
- **FindPrescriptions**  
Find prescriptions and their related documents
- **FindDispenses**  
Find dispense documents and their related documents
- **FindMedicationAdministrations**  
1225 Find administered medication documents and their related documents
- **FindPrescriptionsForValidation**  
Find prescriptions and their related documents containing Prescription Items ready to be validated

- 1230
- **FindPrescriptionsForDispense**  
Find prescriptions and their related documents containing Prescription Items ready to be dispensed
  - **FindMedicationList (if “Provision of Medication List” Option is supported)**  
Find the medication list to the patient

1235 **3.1.4.1.2.1.1 Parameters for Required Queries**

This section defines the parameters and business rules for the Required Queries.

The principle of the following queries is that the result of the query can be divided into a primary and secondary result.

Primary result of the query

- 1240 The primary result of the query are the returning documents according to the type queried (e.g., MTP documents, PRE documents, etc.) where the query parameters are applied.

Secondary result of the query

- 1245 The secondary results of the query are all other documents which are dependent on the primary result. Every returned document has a direct or indirect relation to at least one of the primary result items (included in the documents found as primary result).

These may be ...

- a) ... Community Pharmaceutical Advice documents reflecting validation results, changes, comments directly related to primary result items.
- b) ... documents of other types containing items which are directly<sup>8</sup> or indirectly<sup>9</sup> related to primary result items (MTP, PRE, DIS, CMA documents)
- c) ... Community Pharmaceutical Advice documents reflecting validation results, changes, comments, directly related to items found in rule (b).

- 1255 **Note:** Some business rules include matching rules to FormatCodes (e.g., “FormatCode matches urn:ihe:pharm:pre:2010”).

Projects leveraging IHE Pharmacy profiles may specify additional constraints on the profiles resulting in project-specific templates. This may include the definition of project-specific

---

<sup>8</sup> Direct referencing: The document is directly referencing the primary result item by the corresponding reference element

<sup>9</sup> Indirect referencing: The document is not directly referencing the primary result item, but is part of a chain of referencing documents, where at least one document of the chain is directly referencing the primary result item

1260 FormatCodes for the documents. The business rules may be adjusted to match to such project-specific FormatCodes.

Example: If a project uses own FormatCodes, e.g., “urn:project:prescription:2014” instead of “urn:ihe:pharm:pre:2010” for prescriptions, it may use those in replacement to the ones defined in the profile.

1265

Note: The notion of “context conduction” is highly dependent on the type of information carried by content profiles and its interpretation may be rather diverse and complex. It is therefore recommended not to use contextConductionInd attribute in any element of this profile.

### 1270 3.1.4.1.2.1.1.1 FindMedicationTreatmentPlans

Find Community Medication Treatment Plan documents and their related documents (XDSDocumentEntry objects) containing Medication Treatment Plan Items for a given patientID and other matching attributes. The other parameters can be used to restrict the set of XDSDocumentEntry objects returned.

1275 **Returns:** XDSDocumentEntry objects according to the following business rules.

Business rule 1: Returns *Community Medication Treatment Plan* documents matching the query parameters:

- XDSDocumentEntry matches all required query parameters (PatientID, Status)
- XDSDocumentEntry matches all other optional query parameters
- FormatCode matches **urn:ihe:pharm:mtp:2015**

Business rule 2: Returns related *Community Pharmaceutical Advice* documents to the Medication Treatment Plans found by business rule 1

- XDSDocumentEntry matches all required query parameters (PatientID, Status)
- FormatCode matches **urn:ihe:pharm:padv:2010**
- Community Pharmaceutical Advice document contains a Pharmaceutical Advice Item directly related to a Medication Treatment Plan Item of the found Community Medication Treatment Plan documents

1290



Business rule 3: Returns related *Community Prescription* documents to the Medication Treatment Plans found by business rule 1

- XSDDocumentEntry matches all required query parameters (PatientID, Status)
  - FormatCode matches **urn:ihe:pharm:pre:2010**
- 1295
- Community Prescription document contains a Prescription Entry Item directly or indirectly<sup>10</sup> related to a Medication Treatment Plan Item of the found Community Medication Treatment Plan documents

Business rule 4: Returns related *Community Dispense* documents to the Medication Treatment Plans found by business rule 1

- 1300
- XSDDocumentEntry matches all required query parameters (PatientID, Status)
  - FormatCode matches **urn:ihe:pharm:dis:2010**
- 1305
- Community Dispense document contains a Dispense Entry Item directly or indirectly<sup>11</sup> related to a Medication Treatment Plan Item of the found Community Medication Treatment Plan documents

Business rule 5: Returns related *Community Medication Administration* documents to the Medication Treatment Plans found by business rule 1

- 1310
- XSDDocumentEntry matches all required query parameters (PatientID, Status)
  - FormatCode matches **urn:ihe:pharm:cma:2017**
  - Community Medication Administration document contains a Medication Administration Item directly or indirectly<sup>12</sup> related to a Medication Treatment Plan Item of the found Community Medication Treatment Plan documents

1315 Business rule 6: Returns related *Community Pharmaceutical Advice* documents related to any related document found by business rules 3 to 5

---

<sup>10</sup> See beginning of this section and section „Query result examples“ for further information on direct or indirect relationship of items

<sup>11</sup> See beginning of this section and section „Query result examples“ for further information on direct or indirect relationship of items

<sup>12</sup> See beginning of this section and section „Query result examples“ for further information on direct or indirect relationship of items

- XSDDocumentEntry matches all required query parameters (PatientID, Status)
- FormatCode matches **urn:ihe:pharm:padv:2010**
- Community Pharmaceutical Advice document contains a Pharmaceutical Advice Item directly related to an item contained by documents found by business rules 3 to 5

**Explanation**

Primary result of the query

1325 Returning Community Medication Treatment Plan documents according to business rule 1 is the primary result of the query. It returns Community Medication Treatment Plan documents according to the query parameters.

Secondary result of the query

1330 All other documents being returned shall be seen as secondary result of the query and are dependent on the primary result (found Medication Treatment Plans). Every returned document has a direct or indirect relation to at least one of the Medication Treatment Plan Items of one of the Community Medication Treatment Plan documents found as primary result.

- a) Returning Community Pharmaceutical Advice documents according to business rule 2 reflect validation results, changes, comments, etc. related to Medication Treatment Plan Items of the Community Medication Treatment Plan documents found.
- 1335 b) Returning Community Prescription-, Community Dispense- and Community Medication Administration documents according to business rules 3 to 5 reflect documentation of acts performed at earlier or later stages of the process, which are related to Medication Treatment Plan Items of the Community Medication Treatment Plan documents found.
- 1340 c) Returning Community Pharmaceutical Advice documents according to business rules 6 reflect changes, comments, etc. related to returned documents described in (b).

**Query parameters:**

Parameter Name	Attribute	Opt	Mult
\$XSDDocumentEntryPatientId	XSDDocumentEntry.patientId	R	--
\$XSDDocumentEntryEntryUUID	XSDDocumentEntry.entryUUID	O <sup>1</sup>	M
\$XSDDocumentEntryUniqueId	XSDDocumentEntry.uniqueId	O <sup>1</sup>	M
\$XSDDocumentEntryPracticeSettingCode <sup>3</sup>	XSDDocumentEntry.practiceSettingCode	O	M
\$XSDDocumentEntryCreationTimeFrom	Lower value of XSDDocumentEntry.creationTime	O	--
\$XSDDocumentEntryCreationTimeTo	Upper value of XSDDocumentEntry.creationTime	O	--

Parameter Name	Attribute	Opt	Mult
\$XDSDocumentEntryServiceStartTimeFrom	Lower value of XDSDocumentEntry.serviceStartTime	O	--
\$XDSDocumentEntryServiceStartTimeTo	Upper value of XDSDocumentEntry.serviceStartTime	O	--
\$XDSDocumentEntryServiceStopTimeFrom	Lower value of XDSDocumentEntry.serviceStopTime	O	--
\$XDSDocumentEntryServiceStopTimeTo	Upper value of XDSDocumentEntry.serviceStopTime	O	--
\$XDSDocumentEntryHealthcareFacilityTypeCode <sup>3</sup>	XDSDocumentEntry.healthcareFacilityTypeCode	O	M
\$XDSDocumentEntryEventCodeList <sup>3</sup>	XDSDocumentEntry.eventCodeList <sup>3</sup>	O	M
\$XDSDocumentEntryConfidentialityCode <sup>3</sup>	XDSDocumentEntry.confidentialityCode <sup>3</sup>	O	M
\$XDSDocumentEntryAuthorPerson <sup>4</sup>	XDSDocumentEntry.Author	O	M
\$XDSDocumentEntryStatus <sup>5</sup>	XDSDocumentEntry.availabilityStatus	R	M

1345 <sup>1</sup>Either \$XDSDocumentEntryEntryUUID or \$XDSDocumentEntryUniqueId may be specified in order to be taken into account by Business rule 1. This transaction shall return an error if both parameters are specified.

<sup>3</sup>Shall be coded according to specification in ITI TF-2: 3.18.4.1.2.3.4 Coding of Code/Code-Scheme.

1350 <sup>4</sup>The value for this parameter is a pattern compatible with the SQL keyword LIKE which allows the use of the following wildcard characters: % to match any (or no) characters and \_ to match a single character. The match shall be applied to the text contained in the Value elements of the authorPerson Slot on the author Classification (value strings of the authorPerson sub-attribute).

<sup>5</sup>Implementations should carefully describe their behavior in case “Deprecated” documents are requested and if only “Approved” documents are considered or not.

### 3.1.4.1.2.1.1.2 FindPrescriptions

1355 Find Community Prescription documents and their related documents (XDSDocumentEntry objects) containing Prescription Items for a given patientID and other matching attributes. The other parameters can be used to restrict the set of XDSDocumentEntry objects returned.

**Returns:** XDSDocumentEntry objects according to the following business rules.

- 1360 Business rule 1: Returns *Community Prescription* documents matching the query parameters:
- XSDDocumentEntry matches all required query parameters (PatientID, Status)
  - XSDDocumentEntry matches all other optional query parameters
  - FormatCode matches **urn:ihe:pharm:pre:2010**

- 1365 Business rule 2: Returns related *Community Pharmaceutical Advice* documents to the Prescriptions found by business rule 1
- XSDDocumentEntry matches all required query parameters (PatientID, Status)
  - FormatCode matches **urn:ihe:pharm:padv:2010**
  - Community Pharmaceutical Advice document contains a Pharmaceutical Advice Item directly related to a Prescription Item of the found Community Prescription documents
- 1370

Business rule 3: If Medication Treatment Planning Option is used: Returns related *Community Medication Treatment Plan* documents to the Prescriptions found by business rule 1

- XSDDocumentEntry matches all required query parameters (PatientID, Status)
  - FormatCode matches **urn:ihe:pharm:mtp:2015**
  - Community Medication Treatment Plan document contains a Medication Treatment Plan Entry Item directly or indirectly<sup>13</sup> related to a Prescription Item of the found Community Prescription documents
- 1375

- 1380 Business rule 4: Returns related *Community Dispense* documents to the Prescriptions found by business rule 1

- XSDDocumentEntry matches all required query parameters (PatientID, Status)
  - FormatCode matches **urn:ihe:pharm:dis:2010**
  - Community Dispense document contains a Dispense Entry Item directly or indirectly<sup>14</sup> related to a Prescription Item of the found Community Prescription documents
- 1385

---

<sup>13</sup> See beginning of this section and section „Query result examples“ for further information on direct or indirect relationship of items

<sup>14</sup> See beginning of this section and section „Query result examples“ for further information on direct or indirect relationship of items

Business rule 5: Returns related *Community Medication Administration* documents to the Prescriptions found by business rule 1

- XSDDocumentEntry matches all required query parameters (PatientID, Status)
- 1390 • FormatCode matches **urn:ihe:pharm:cma:2017**
- Community Medication Administration document contains a Medication Administration Item directly or indirectly<sup>15</sup> related to a Prescription Item of the found Community Prescription documents

1395 Business rule 6: Returns related *Community Pharmaceutical Advice* documents directly related to any related document found by business rules 3 to 5

- XSDDocumentEntry matches all required query parameters (PatientID, Status)
- FormatCode matches **urn:ihe:pharm:padv:2010**
- Community Pharmaceutical Advice document contains a Pharmaceutical Advice Item directly related to an item contained by documents found by business rules 3 to 5

1400

### **Explanation**

#### Primary result of the query

Returning Community Prescription documents according to business rule 1 is the primary result of the query. It returns Community Prescription documents according to the query parameters.

1405 Secondary result of the query

All other documents being returned shall be seen as a secondary result of the query and are dependent on the primary result (found Prescriptions). Every returned document has a direct or indirect relation to at least one of the Prescription Items of one of the Prescriptions found as primary result.

- 1410 a) Returning Community Pharmaceutical Advice documents according to business rule 2 reflect validation results, changes, comments, etc. related to Prescription Items of the Dispenses found.
- 1415 b) Returning Community Medication Treatment Plan-, Dispense and Community Medication Administration documents according to business rules 3 to 5 reflect documentation of acts performed at earlier or later stages of the process, which are related to Prescription Items of the Prescription found.

---

<sup>15</sup> See beginning of this section and section „Query result examples“ for further information on direct or indirect relationship of items

- c) Returning Community Pharmaceutical Advice documents according to business rules 6 reflect changes, comments, etc. related to returned documents described in (b).

1420 **Query parameters:**

Parameter Name	Attribute	Opt	Mult
\$XDSDocumentEntryPatientId	XSDocumentEntry.patientId	R	--
\$XDSDocumentEntryEntryUUID	XSDocumentEntry.entryUUID	O <sup>1</sup>	M
\$XDSDocumentEntryUniqueId	XSDocumentEntry.uniqueId	O <sup>1</sup>	M
\$XDSDocumentEntryPracticeSettingCode <sup>3</sup>	XSDocumentEntry.practiceSettingCode	O	M
\$XDSDocumentEntryCreationTimeFrom	Lower value of XSDocumentEntry.creationTime	O	--
\$XDSDocumentEntryCreationTimeTo	Upper value of XSDocumentEntry.creationTime	O	--
\$XDSDocumentEntryServiceStartTimeFrom	Lower value of XSDocumentEntry.serviceStartTime	O	--
\$XDSDocumentEntryServiceStartTimeTo	Upper value of XSDocumentEntry.serviceStartTime	O	--
\$XDSDocumentEntryServiceStopTimeFrom	Lower value of XSDocumentEntry.serviceStopTime	O	--
\$XDSDocumentEntryServiceStopTimeTo	Upper value of XSDocumentEntry.serviceStopTime	O	--
\$XDSDocumentEntryHealthcareFacilityTypeCode <sup>3</sup>	XSDocumentEntry.healthcareFacilityTypeCode	O	M
\$XDSDocumentEntryEventCodeList <sup>3</sup>	XSDocumentEntry.eventCodeList <sup>3</sup>	O	M
\$XDSDocumentEntryConfidentialityCode <sup>3</sup>	XSDocumentEntry.confidentialityCode <sup>3</sup>	O	M
\$XDSDocumentEntryAuthorPerson <sup>4</sup>	XSDocumentEntry.Author	O	M
\$XDSDocumentEntryStatus <sup>5</sup>	XSDocumentEntry.availabilityStatus	R	M

<sup>1</sup>Either \$XDSDocumentEntryEntryUUID or \$XDSDocumentEntryUniqueId may be specified in order to be taken into account by Business rule 1. This transaction shall return an error if both parameters are specified.

1425 <sup>3</sup>Shall be coded according to specification in ITI TF-2: 3.18.4.1.2.3.4 Coding of Code/Code-Scheme.

<sup>4</sup>The value for this parameter is a pattern compatible with the SQL keyword LIKE which allows the use of the following wildcard characters: % to match any (or no) characters and \_ to match a single character. The match shall be applied to the text contained in the Value elements of the authorPerson Slot on the author Classification (value strings of the authorPerson sub-attribute)

1430

<sup>5</sup>Implementations should carefully describe their behavior in case “Deprecated” documents are requested and if only “Approved” documents are considered or not.

### 3.1.4.1.2.1.1.3 FindDispenses

1435 Find Community Dispense documents and their related documents (XDSDocumentEntry objects) containing Dispense Items for a given patientID and other matching attributes. The other parameters can be used to restrict the set of XDSDocumentEntry objects returned.

**Returns:** XDSDocumentEntry objects according to the following business rules.

1440 Business rule 1: Returns *Community Dispense* documents matching the query parameters:

- XDSDocumentEntry matches all required query parameters (PatientID, Status)
- XDSDocumentEntry matches all other optional query parameters
- FormatCode matches **urn:ihe:pharm:dis:2010**

1445 Business rule 2: Returns related *Community Pharmaceutical Advice* documents to the Dispenses found by business rule 1

- XDSDocumentEntry matches all required query parameters (PatientID, Status)
- FormatCode matches **urn:ihe:pharm:padv:2010**
- Community Pharmaceutical Advice document contains a Pharmaceutical Advice Item directly related to a Dispense Item of the found Community Dispense documents

1450

Business rule 3: If Medication Treatment Planning Option is used: Returns related *Community Medication Treatment Plan* documents to the Dispenses found by business rule 1

- XDSDocumentEntry matches all required query parameters (PatientID, Status)
- FormatCode matches **urn:ihe:pharm:mtp:2015**

1455

- Community Medication Treatment Plan document contains a Medication Treatment Plan Entry Item directly or indirectly<sup>16</sup> related to a Dispense Item of the found Community Dispense documents

1460 Business rule 4: Returns related *Community Prescription* documents to the Dispenses found by business rule 1

- XSDDocumentEntry matches all required query parameters (PatientID, Status)
- FormatCode matches **urn:ihe:pharm:pre:2010**
- Community Prescription document contains a Prescription Entry Item directly or

1465 indirectly<sup>17</sup> related to a Dispense Item of the found Community Dispense documents

Business rule 5: Returns related *Community Medication Administration* documents to the Dispenses found by business rule 1

- XSDDocumentEntry matches all required query parameters (PatientID, Status)
- FormatCode matches **urn:ihe:pharm:cma:2017**

1470 • Community Medication Administration document contains a Medication Administration Item directly or indirectly<sup>18</sup> related to a Dispense Item of the found Community Dispense documents

1475 Business rule 6: Returns related *Community Pharmaceutical Advice* documents related to any related document found by business rules 3 to 5

- XSDDocumentEntry matches all required query parameters (PatientID, Status)
- FormatCode matches **urn:ihe:pharm:padv:2010**
- Community Pharmaceutical Advice document contains a Pharmaceutical Advice Item directly related to an item contained by documents found by business rules 3 to 5

1480

## Explanation

---

<sup>16</sup> See beginning of this section and section „Query result examples“ for further information on direct or indirect relationship of items

<sup>17</sup> See beginning of this section and section „Query result examples“ for further information on direct or indirect relationship of items

<sup>18</sup> See beginning of this section and section „Query result examples“ for further information on direct or indirect relationship of items



Primary result of the query

Returning Community Dispense documents according to business rule 1 is the primary result of the query. It returns Community Dispense documents according to the query parameters.

1485 Secondary result of the query

All other documents being returned shall be seen as secondary result of the query and are dependent on the primary result (found Dispenses). Every returned document has a direct or indirect relation to at least one of the Dispense Items of one of the Dispenses found as primary result.

- 1490 a) Returning Community Pharmaceutical Advice documents according to business rule 2 reflect validation results, changes, comments, etc. related to Dispense Items of the Dispenses found.
- b) Returning Community Medication Treatment Plan-, Community Prescription and Community Medication Administration documents according to business rules 3 to 5 reflect documentation of acts performed at earlier or later stages of the process, which are related to Dispense Items of the Dispenses found.
- 1495 c) Returning Community Pharmaceutical Advice documents according to business rules 6 reflect changes, comments, etc. related to returned documents described in (b).

1500 **Query parameters:**

Parameter Name	Attribute	Opt	Mult
\$XDSDocumentEntryPatientId	XDSDocumentEntry.patientId	R	--
\$XDSDocumentEntryEntryUUID	XDSDocumentEntry.entryUUID	O <sup>1</sup>	M
\$XDSDocumentEntryUniqueId	XDSDocumentEntry.uniqueId	O <sup>1</sup>	M
\$XDSDocumentEntryPracticeSettingCode <sup>3</sup>	XDSDocumentEntry.practiceSettingCode	O	M
\$XDSDocumentEntryCreationTimeFrom	Lower value of XDSDocumentEntry.creationTime	O	--
\$XDSDocumentEntryCreationTimeTo	Upper value of XDSDocumentEntry.creationTime	O	--
\$XDSDocumentEntryServiceStartTimeFrom	Lower value of XDSDocumentEntry.serviceStartTime	O	--
\$XDSDocumentEntryServiceStartTimeTo	Upper value of XDSDocumentEntry.serviceStartTime	O	--
\$XDSDocumentEntryServiceStopTimeFrom	Lower value of XDSDocumentEntry.serviceStopTime	O	--

Parameter Name	Attribute	Opt	Mult
\$XDSDocumentEntryServiceStopTimeTo	Upper value of XDSDocumentEntry.serviceStopTime	O	--
\$XDSDocumentEntryHealthcareFacilityTypeCode <sup>3</sup>	XDSDocumentEntry.healthcareFacilityTypeCode	O	M
\$XDSDocumentEntryEventCodeList <sup>3</sup>	XDSDocumentEntry.eventCodeList <sup>3</sup>	O	M
\$XDSDocumentEntryConfidentialityCode <sup>3</sup>	XDSDocumentEntry.confidentialityCode <sup>3</sup>	O	M
\$XDSDocumentEntryAuthorPerson <sup>4</sup>	XDSDocumentEntry.Author	O	M
\$XDSDocumentEntryStatus <sup>5</sup>	XDSDocumentEntry.availabilityStatus	R	M

<sup>1</sup>Either \$XDSDocumentEntryEntryUUID or \$XDSDocumentEntryUniqueID may be specified in order to be taken into account by Business rule 1. This transaction shall return an error if both parameters are specified.

1505 <sup>3</sup>Shall be coded according to specification in ITI TF-2: 3.18.4.1.2.3.4 Coding of Code/Code-Scheme.

1510 <sup>4</sup>The value for this parameter is a pattern compatible with the SQL keyword LIKE which allows the use of the following wildcard characters: % to match any (or no) characters and \_ to match a single character. The match shall be applied to the text contained in the Value elements of the authorPerson Slot on the author Classification (value strings of the authorPerson sub-attribute)

<sup>5</sup>Implementations should carefully describe their behavior in case “Deprecated” documents are requested and if only “Approved” documents are considered or not.

### 3.1.4.1.2.1.1.4 FindMedicationAdministrations

1515 Find Community Medication Administration documents and their related documents (XDSDocumentEntry objects) containing Medication Administration Items for a given patientID and other matching attributes. The other parameters can be used to restrict the set of XDSDocumentEntry objects returned.

**Returns:** XDSDocumentEntry objects according to the following business rules.

1520

Business rule 1: Returns *Community Medication Administration* documents matching the query parameters:

- XDSDocumentEntry matches all required query parameters (PatientID, Status)
- XDSDocumentEntry matches all other optional query parameters

- 1525
- FormatCode matches **urn:ihe:pharm:cma:2017**

Business rule 2: Returns related *Community Pharmaceutical Advice* documents to the Medication Administrations found by business rule 1

- XSDDocumentEntry matches all required query parameters (PatientID, Status)
- 1530
- FormatCode matches **urn:ihe:pharm:padv:2010**
  - Community Pharmaceutical Advice document contains a Pharmaceutical Advice Item directly related to a Medication Administration Item of the found Community Medication Administration documents

1535 Business rule 3: If Medication Treatment Planning Option is used: Returns related *Community Medication Treatment Plan* documents to the Medication Administrations found by business rule 1

- XSDDocumentEntry matches all required query parameters (PatientID, Status)
  - FormatCode matches **urn:ihe:pharm:mtp:2015**
- 1540
- Community Medication Treatment Plan document contains a Medication Treatment Plan Entry Item directly or indirectly<sup>19</sup> related to a Medication Administration Item of the found Community Medication Administration documents

Business rule 4: Returns related *Community Prescription* documents to the Medication Administrations found by business rule 1

- 1545
- XSDDocumentEntry matches all required query parameters (PatientID, Status)
  - FormatCode matches **urn:ihe:pharm:pre:2010**
  - Community Prescription document contains a Prescription Entry Item directly or indirectly<sup>20</sup> related to a Medication Administration Item of the found Community Medication Administration documents
- 1550

---

<sup>19</sup> See beginning of this section and section „Query result examples“ for further information on direct or indirect relationship of items

<sup>20</sup> See beginning of this section and section „Query result examples“ for further information on direct or indirect relationship of items

Business rule 5: Returns related *Community Dispense* documents to the Medication Administrations found by business rule 1

- XSDDocumentEntry matches all required query parameters (PatientID, Status)
- 1555 • FormatCode matches **urn:ihe:pharm:dis:2010**
- Community Dispense document contains a Dispense Item directly or indirectly<sup>21</sup> related to a Medication Administration Item of the found Community Medication Administration documents

1560 Business rule 6: Returns related *Community Pharmaceutical Advice* documents related to any related document found by business rules 3 to 5

- XSDDocumentEntry matches all required query parameters (PatientID, Status)
- FormatCode matches **urn:ihe:pharm:padv:2010**
- 1565 • Community Pharmaceutical Advice document contains a Pharmaceutical Advice Item directly related to an item contained by documents found by business rules 3 to 5

## Explanation

### Primary result of the query

- 1570 Returning Community Medication Administration documents according to business rule 1 is the primary result of the query. It returns Community Medication Administration documents according to the query parameters.

### Secondary result of the query

- 1575 All other documents being returned shall be seen as secondary result of the query and are dependent on the primary result (found Medication Administrations). Every returned document has a direct or indirect relation to at least one of the Medication Administration Items of one of the Medication Administration found as primary result.

- a) Returning Community Pharmaceutical Advice documents according to business rule 2 reflect validation results, changes, comments, etc. related to Medication Administration Items of the Medication Administrations found.
- 1580 b) Returning Community Medication Treatment Plan-, Community Prescription and Community Dispense documents according to business rules 3 to 5 reflect documentation

---

<sup>21</sup> See beginning of this section and section „Query result examples“ for further information on direct or indirect relationship of items

of acts performed at earlier or later stages of the process, which are related to Medication Administration Items of the Medication Administrations found.

- 1585 c) Returning Community Pharmaceutical Advice documents according to business rules 6 reflect changes, comments, etc. related to returned documents described in (b).

**Query parameters:**

Parameter Name	Attribute	Opt	Mult
\$XDSDocumentEntryPatientId	XDSDocumentEntry.patientId	R	--
\$XDSDocumentEntryEntryUUID	XDSDocumentEntry.entryUUID	O <sup>1</sup>	M
\$XDSDocumentEntryUniqueId	XDSDocumentEntry.uniqueId	O <sup>1</sup>	M
\$XDSDocumentEntryPracticeSettingCode <sup>3</sup>	XDSDocumentEntry.practiceSettingCode	O	M
\$XDSDocumentEntryCreationTimeFrom	Lower value of XDSDocumentEntry.creationTime	O	--
\$XDSDocumentEntryCreationTimeTo	Upper value of XDSDocumentEntry.creationTime	O	--
\$XDSDocumentEntryServiceStartTimeFrom	Lower value of XDSDocumentEntry.serviceStartTime	O	--
\$XDSDocumentEntryServiceStartTimeTo	Upper value of XDSDocumentEntry.serviceStartTime	O	--
\$XDSDocumentEntryServiceStopTimeFrom	Lower value of XDSDocumentEntry.serviceStopTime	O	--
\$XDSDocumentEntryServiceStopTimeTo	Upper value of XDSDocumentEntry.serviceStopTime	O	--
\$XDSDocumentEntryHealthcareFacilityTypeCode <sup>3</sup>	XDSDocumentEntry.healthcareFacilityTypeCode	O	M
\$XDSDocumentEntryEventCodeList <sup>3</sup>	XDSDocumentEntry.eventCodeList <sup>3</sup>	O	M
\$XDSDocumentEntryConfidentialityCode <sup>3</sup>	XDSDocumentEntry.confidentialityCode <sup>3</sup>	O	M
\$XDSDocumentEntryAuthorPerson <sup>4</sup>	XDSDocumentEntry.Author	O	M
\$XDSDocumentEntryStatus <sup>5</sup>	XDSDocumentEntry.availabilityStatus	R	M

1590 <sup>1</sup>Either \$XDSDocumentEntryEntryUUID or \$XDSDocumentEntryUniqueId may be specified in order to be taken into account by Business rule 1. This transaction shall return an error if both parameters are specified.

<sup>3</sup>Shall be coded according to specification in ITI TF-2: 3.18.4.1.2.3.4 Coding of Code/Code-Scheme.

1595 <sup>4</sup>The value for this parameter is a pattern compatible with the SQL keyword LIKE which allows the use of the following wildcard characters: % to match any (or no) characters and \_ to match a single character. The match shall be applied to the text contained in the Value elements of the authorPerson Slot on the author Classification (value strings of the authorPerson sub-attribute)

<sup>5</sup>Implementations should carefully describe their behavior in case “Deprecated” documents are requested and if only “Approved” documents are considered or not.

1600

### 3.1.4.1.2.1.1.5 FindPrescriptionsForValidation

Find prescriptions and their related documents (XDSDocumentEntry objects) containing Prescription Items *ready to be validated* for a given patientID and other matching attributes. The other parameters can be used to restrict the set of XDSDocumentEntry objects returned.

1605 **Returns:** XDSDocumentEntry objects according to the following business rules.

Note: The business rules are depending on the workflow scenario used (see Vol. 1, Section 4.4 CMPD Process Flow).

1610 This query is only used in scenario 1 “Including validation step”. It is not used in scenario 2 “Not including validation step” except for prescriptions containing provisional Prescription Items, which require a validation step by a prescriber.

Business rule 1: Returns *Community Prescription* documents matching the query parameters:

- XDSDocumentEntry matches all required query parameters (PatientID, Status)
- XDSDocumentEntry matches all other optional query parameters
- FormatCode matches **urn:ihe:pharm:pre:2010**
- Community Prescription document contains at least one Prescription Item ready to validate
  - Scenario 1, a Prescription Item is ready to validate if there exists no Pharmaceutical Advice Item related to it which has statusCode set to “completed”<sup>22</sup>. Pharmaceutical Advice with an observation code=”COMMENT” are not taken into account.

---

<sup>22</sup> See the Pharmacy Pharmaceutical Advice Content Profile (PADV) for details about the statusCode element (section “Status Code”)

- 1625
- Scenario 2, a Prescription Item is ready to validate if there exists no Pharmaceutical Advice Item related to it which has statusCode set to “completed”<sup>23</sup> and the Prescription Item is “provisional”<sup>24</sup>. Pharmaceutical Advice with an observation code=“COMMENT” are not taken into account.

Business rule 2: Returns related *Community Pharmaceutical Advice* documents to the Prescriptions found by business rule 1

- 1630
- XDSDocumentEntry matches all required query parameters (PatientID, Status)
  - FormatCode matches **urn:ihe:pharm:padv:2010**
  - Community Pharmaceutical Advice document contains a Pharmaceutical Advice Item directly related to a Prescription Item of the found Community Prescription documents

1635 Business rule 3: If Medication Treatment Planning Option is used: Returns related *Community Medication Treatment Plan* documents to the Prescriptions found by business rule 1

- 1640
- XDSDocumentEntry matches all required query parameters (PatientID, Status)
  - FormatCode matches **urn:ihe:pharm:mtp:2015**
  - Community Medication Treatment Plan document contains a Medication Treatment Plan Entry Item directly or indirectly<sup>25</sup> related to a Prescription Item of the found Community Prescription documents

Business rule 4: Returns related *Community Dispense* documents to the Prescriptions found by business rule 1

- 1645
- XDSDocumentEntry matches all required query parameters (PatientID, Status)
  - FormatCode matches **urn:ihe:pharm:dis:2010**

---

<sup>23</sup> See the Pharmacy Pharmaceutical Advice Content Profile (PADV) for details about the statusCode element (section “Status Code”)

<sup>24</sup> See the Pharmacy Prescription Content Profile (PRE) for details about indicating that a Prescription Item is provisional (“Reference to Validation Step”).

<sup>25</sup> See beginning of this section and section „Query result examples“ for further information on direct or indirect relationship of items

- Community Dispense document contains a Dispense Entry Item directly or indirectly<sup>26</sup> related to a Prescription Item of the found Community Prescription documents

Business rule 5: Returns related *Community Medication Administration* documents to the Prescriptions found by business rule 1

- 1650
- XSDDocumentEntry matches all required query parameters (PatientID, Status)
  - FormatCode matches **urn:ihe:pharm:cma:2017**
  - Community Medication Administration document contains a Medication Administration Item directly or indirectly<sup>27</sup> related to a Prescription Item of the found Community Prescription documents

1655

Business rule 6: Returns related *Community Pharmaceutical Advice* documents related to any related document found by business rules 3 to 5

- XSDDocumentEntry matches all required query parameters (PatientID, Status)
  - FormatCode matches **urn:ihe:pharm:padv:2010**
- 1660
- Community Pharmaceutical Advice document contains a Pharmaceutical Advice Item directly related to an item contained by documents found by business rules 3 to 5

## Explanation

### Primary result of the query

- 1665
- Returning Community Prescription documents according to business rule 1 is the primary result of the query. It returns Community Prescription documents according to the query parameters.

### Secondary result of the query

- 1670
- All other documents being returned shall be seen as secondary result of the query and are dependent on the primary result (found Prescriptions). Every returned document has a direct or indirect relation to at least one of the Prescription Items of one of the Prescriptions found as primary result.

---

<sup>26</sup> See beginning of this section and section „Query result examples“ for further information on direct or indirect relationship of items

<sup>27</sup> See beginning of this section and section „Query result examples“ for further information on direct or indirect relationship of items



- 1675 a) Returning Community Pharmaceutical Advice documents according to business rule 2 reflect validation results, changes, comments, etc. related to Prescription Items of the Prescriptions found.
- b) Returning Community Medication Treatment Plan-, Community Dispense- and Community Medication Administration documents according to business rules 3 to 5 reflect documentation of acts performed at earlier or later stages of the process, which are related to Prescription Items of the Prescriptions found.
- 1680 c) Returning Community Pharmaceutical Advice documents according to business rules 6 reflect changes, comments, etc. related to returned documents described in (b).

**Query parameters:**

Parameter Name	Attribute	Opt	Mult
\$XDSDocumentEntryPatientId	XDSDocumentEntry.patientId	R	--
\$XDSDocumentEntryEntryUUID	XDSDocumentEntry.entryUUID	O <sup>1</sup>	M
\$XDSDocumentEntryUniqueId	XDSDocumentEntry.uniqueId	O <sup>1</sup>	M
\$XDSDocumentEntryPracticeSettingCode <sup>3</sup>	XDSDocumentEntry.practiceSettingCode	O	M
\$XDSDocumentEntryCreationTimeFrom	Lower value of XDSDocumentEntry.creationTime	O	--
\$XDSDocumentEntryCreationTimeTo	Upper value of XDSDocumentEntry.creationTime	O	--
\$XDSDocumentEntryServiceStartTimeFrom	Lower value of XDSDocumentEntry.serviceStartTime	O	--
\$XDSDocumentEntryServiceStartTimeTo	Upper value of XDSDocumentEntry.serviceStartTime	O	--
\$XDSDocumentEntryServiceStopTimeFrom	Lower value of XDSDocumentEntry.serviceStopTime	O	--
\$XDSDocumentEntryServiceStopTimeTo	Upper value of XDSDocumentEntry.serviceStopTime	O	--
\$XDSDocumentEntryHealthcareFacilityTypeCode <sup>3</sup>	XDSDocumentEntry.healthcareFacilityTypeCode	O	M
\$XDSDocumentEntryEventCodeList <sup>3</sup>	XDSDocumentEntry.eventCodeList <sup>3</sup>	O	M
\$XDSDocumentEntryConfidentialityCode <sup>3</sup>	XDSDocumentEntry.confidentialityCode <sup>3</sup>	O	M
\$XDSDocumentEntryAuthorPerson <sup>4</sup>	XDSDocumentEntry.Author	O	M

Parameter Name	Attribute	Opt	Mult
\$XDSDocumentEntryStatus <sup>5</sup>	XDSDocumentEntry.availabilityStatus	R	M

1685 <sup>1</sup>Either \$XDSDocumentEntryEntryUUID or \$XDSDocumentEntryUniqueId may be specified in order to be taken into account by Business rule 1. This transaction shall return an error if both parameters are specified.

<sup>3</sup>Shall be coded according to specification in ITI TF-2: 3.18.4.1.2.3.4 Coding of Code/Code-Scheme.

1690 <sup>4</sup>The value for this parameter is a pattern compatible with the SQL keyword LIKE which allows the use of the following wildcard characters: % to match any (or no) characters and \_ to match a single character. The match shall be applied to the text contained in the Value elements of the authorPerson Slot on the author Classification (value strings of the authorPerson sub-attribute)

<sup>5</sup>Implementations should carefully describe their behavior in case “Deprecated” documents are requested and if only “Approved” documents are considered or not.

1695 **3.1.4.1.2.1.1.6 FindPrescriptionsForDispense**

Find prescriptions and their related documents (XDSDocumentEntry objects) containing Prescription Items *ready to be dispensed* for a given patientID and other matching attributes. The other parameters can be used to restrict the set of XDSDocumentEntry objects returned.

**Returns:** XDSDocumentEntry objects according to the following business rules:

1700

Business rule 1: Returns *Community Prescription* documents matching the query parameters:

- XDSDocumentEntry matches all required query parameters (PatientID, Status)
- XDSDocumentEntry matches all other optional query parameters
- FormatCode matches **urn:ihe:pharm:pre:2010**
- Community Prescription document contains at least one Prescription Item ready to dispense
  - Scenario 1 “Including validation step”: A Prescription Item is ready to dispense if the last Pharmaceutical Advice Item related to it has statusCode set to “completed” and Observation Code set to either OK or CHANGE. <sup>28</sup>
  - Scenario 2 “Not including validation step”: A non-provisional Prescription Item is ready to be dispensed, if either no Pharmaceutical Advice Item related to it exists or

1705

1710

---

<sup>28</sup> See the Pharmacy Pharmaceutical Advice Content Profile (PADV) for details about the statusCode and Observation code elements

the last Pharmaceutical Advice Item related to it has statusCode set to “completed” and Observation Code set to either OK or CHANGE.<sup>29</sup> For provisional Prescription Items, the rule of Scenario 1 applies.

1715

Business rule 2: Returns related *Community Pharmaceutical Advice* documents to the Prescriptions found by business rule 1

- XDSDocumentEntry matches all required query parameters (PatientID, Status)
- FormatCode matches **urn:ihe:pharm:padv:2010**

1720

- Community Pharmaceutical Advice document contains a Pharmaceutical Advice Item directly related to a Prescription Item of the found Community Prescription documents

Business rule 3: If Medication Treatment Planning Option is used: Returns related *Community Medication Treatment Plan* documents to the Prescriptions found by business rule 1

1725

- XDSDocumentEntry matches all required query parameters (PatientID, Status)
- FormatCode matches **urn:ihe:pharm:mtp:2015**
- Community Medication Treatment Plan document contains a Medication Treatment Plan Entry Item directly or indirectly<sup>30</sup> related to a Prescription Item of the found Community Prescription documents

1730

Business rule 4: Returns related *Community Dispense* documents to the Prescriptions found by business rule 1

- XDSDocumentEntry matches all required query parameters (PatientID, Status)
- FormatCode matches **urn:ihe:pharm:dis:2010**

1735

- Community Dispense document contains a Dispense Entry Item directly or indirectly<sup>31</sup> related to a Prescription Item of the found Community Prescription documents

---

<sup>29</sup> See the Pharmacy Pharmaceutical Advice Content Profile (PADV) for details about the statusCode and Observation code elements

<sup>30</sup> See beginning of this section and section „Query result examples“ for further information on direct or indirect relationship of items

<sup>31</sup> See beginning of this section and section „Query result examples“ for further information on direct or indirect relationship of items

Business rule 5: Returns related *Community Medication Administration* documents to the Prescriptions found by business rule 1

- 1740
- XSDDocumentEntry matches all required query parameters (PatientID, Status)
  - FormatCode matches **urn:ihe:pharm:cma:2017**
  - Community Medication Administration document contains a Medication Administration Item directly or indirectly<sup>32</sup> related to a Prescription Item of the found Community Prescription documents

1745

Business rule 6: Returns related *Community Pharmaceutical Advice* documents related to any related document found by business rules 3 to 5

- XSDDocumentEntry matches all required query parameters (PatientID, Status)
  - FormatCode matches **urn:ihe:pharm:padv:2010**
- 1750
- Community Pharmaceutical Advice document contains a Pharmaceutical Advice Item directly related to an item contained by documents found by business rules 3 to 5

## Explanation

### Primary result of the query

- 1755
- Returning Community Prescription documents according to business rule 1 is the primary result of the query. It returns Community Prescription documents according to the query parameters.

### Secondary result of the query

- 1760
- All other documents being returned shall be seen as secondary result of the query and are dependent on the primary result (found Prescriptions). Every returned document has a direct or indirect relation to at least one of the Prescription Items of one of the Prescriptions found as primary result.

- 1765
- a) Returning Community Pharmaceutical Advice documents according to business rule 2 reflect validation results, changes, comments, etc. related to Prescription Items of the Prescriptions found.
  - b) Returning Community Medication Treatment Plan-, Community Dispense- and Community Medication Administration documents according to business rules 3 to 5 reflect documentation of acts performed at earlier or later stages of the process, which are related to Prescription Items of the Prescriptions found.

---

<sup>32</sup> See beginning of this section and section „Query result examples“ for further information on direct or indirect relationship of items

1770

- c) Returning Community Pharmaceutical Advice documents according to business rules 6 reflect changes, comments, etc. related to returned documents described in (b).

**Query parameters:**

Parameter Name	Attribute	Opt	Mult
\$XDSDocumentEntryPatientId	XDSDocumentEntry.patientId	R	--
\$XDSDocumentEntryEntryUUID	XDSDocumentEntry.entryUUID	O <sup>1</sup>	M
\$XDSDocumentEntryUniqueId	XDSDocumentEntry.uniqueId	O <sup>1</sup>	M
\$XDSDocumentEntryPracticeSettingCode <sup>3</sup>	XDSDocumentEntry.practiceSettingCode	O	M
\$XDSDocumentEntryCreationTimeFrom	Lower value of XDSDocumentEntry.creationTime	O	--
\$XDSDocumentEntryCreationTimeTo	Upper value of XDSDocumentEntry.creationTime	O	--
\$XDSDocumentEntryServiceStartTimeFrom	Lower value of XDSDocumentEntry.serviceStartTime	O	--
\$XDSDocumentEntryServiceStartTimeTo	Upper value of XDSDocumentEntry.serviceStartTime	O	--
\$XDSDocumentEntryServiceStopTimeFrom	Lower value of XDSDocumentEntry.serviceStopTime	O	--
\$XDSDocumentEntryServiceStopTimeTo	Upper value of XDSDocumentEntry.serviceStopTime	O	--
\$XDSDocumentEntryHealthcareFacilityTypeCode <sup>3</sup>	XDSDocumentEntry.healthcareFacilityTypeCode	O	M
\$XDSDocumentEntryEventCodeList <sup>3</sup>	XDSDocumentEntry.eventCodeList <sup>3</sup>	O	M
\$XDSDocumentEntryConfidentialityCode <sup>3</sup>	XDSDocumentEntry.confidentialityCode <sup>3</sup>	O	M
\$XDSDocumentEntryAuthorPerson <sup>4</sup>	XDSDocumentEntry.Author	O	M
\$XDSDocumentEntryStatus <sup>5</sup>	XDSDocumentEntry.availabilityStatus	R	M

1775

<sup>1</sup>Either \$XDSDocumentEntryEntryUUID or \$XDSDocumentEntryUniqueId may be specified in order to be taken into account by Business rule 1. This transaction shall return an error if both parameters are specified.

<sup>3</sup>Shall be coded according to specification in ITI TF-2: 3.18.4.1.2.3.4 Coding of Code/Code-Scheme.

1780 <sup>4</sup>The value for this parameter is a pattern compatible with the SQL keyword LIKE which allows the use of the following wildcard characters: % to match any (or no) characters and \_ to match a single character. The match shall be applied to the text contained in the Value elements of the authorPerson Slot on the author Classification (value strings of the authorPerson sub-attribute)

<sup>5</sup>Implementations should carefully describe their behavior in case “Deprecated” documents are requested and if only “Approved” documents are considered or not.

1785 **3.1.4.1.2.1.1.7 FindMedicationList**

Find the Community Medication List On-Demand Document (XDSDocumentEntry object) according to the Community Medication List (PML) Profile containing Medication Treatment Plan-, Prescription-, Dispense- and Medication Administration Items for a given patientID and other matching attributes.

1790 **Returns:** XDSDocumentEntry object according to the following business rules.

Business rule 1: Returns *Community Medication List* documents

1795 This is the basic and ready to implement mechanism to retrieve a medication list. In this case, the Community Pharmacy Manager contains, or has access to, business rules to retrieve an existing list, or to create the patient’s medication list generated from the Community Medication Treatment Plan-, Community Prescription-, Community Dispense- and Community Medication Administration documents of the patient.

A set of parameters is provided in the query to obtain such list:

- XDSDocumentEntry matches all the required query parameters below (PatientID, ...)
- FormatCode of the returned document match **urn:ihe:pharm:pml:2013** (implicit business rule, parameter shall not be given in parameter list)

**Query parameters:**

Parameter Name	Attribute	Opt	Mult
\$XDSDocumentEntryPatientId	XDSDocumentEntry.patientId	R	--
The following yellow parameters are parameters to parameterize the business logic for assembling of the resulting Community Medication List document:			
\$XDSDocumentEntryServiceStartFrom	For the meaning of these parameters see explanation below.	O	--
\$XDSDocumentEntryServiceStartTo		O	--
\$XDSDocumentEntryServiceEndFrom		O	--
\$XDSDocumentEntryServiceEndTo		O	--

Parameter Name	Attribute	Opt	Mult
\$XDSDocumentEntryFormatCode		O <sup>33</sup>	M
\$XDSDocumentEntryType		O34	M
\$XDSDocumentEntryStatus	XDSDocumentEntry.Status	R	M

1805 **Explanation of yellow parameters**

1) *\$XDSDocumentEntryServiceStartFrom, \$XDSDocumentEntryServiceStartTo*

This query parameter is used to find all medication treatments that were started during the interval specified by the requester. The exact definition of the starting point of a medication treatment is not in the scope of this profile.

1810 For example:

- (1) find and return all medication treatments that were started between Nov 2012 and June 2013
- (2) find and return all medication treatments that were started in the last 3 months

2) *\$XDSDocumentEntryServiceEndFrom, \$XDSDocumentEntryServiceEndTo,*

1815 This query parameter is used to find all medication treatments that were finished / completed in the interval specified by the requester. The exact definition of the point where a medication treatment is finished/completed is not in the scope of this profile.

For example:

- 1820
- (1) find and return all medication treatments that were completed between Nov 2012 and June 2013
  - (2) find and return all medication treatments that were completed in the last 3 months or are not yet completed

3) *\$XDSDocumentEntryFormatCode*

1825 If this parameter is given just the given type of information shall be returned in the Medication List.

---

<sup>33</sup> Note: Omitting this parameter means that no filtering according to format code takes place, so “all” available data types will be returned.

<sup>34</sup> Note: Omitting this parameter means that “all” available types of Medication List documents (on-demand created or previously persisted snapshots) are returned. It has to be taken into consideration however that persisted snapshots may exist only of “Persistence of Retrieved Documents” Option is used.

Parameter	Meaning
urn:ihe:pharm:mtp:2015	Medication Treatment Plan Items shall be returned (and optional the related Community Pharmaceutical Advice documents related to them).
urn:ihe:pharm:pre:2010	Prescription Items shall be returned (and optional the related Community Pharmaceutical Advice documents related to them).
urn:ihe:pharm:dis:2010	Dispense Items shall be returned (and optional the related Community Pharmaceutical Advice documents related to them).
urn:ihe:pharm:cma:2017	Medication Administration Items shall be returned (and optional the related Community Pharmaceutical Advice documents related to them).

4) *\$XDSDocumentEntryType*

1830 If this parameter is given documents of just the provided document entry type (on-demand or stable) shall be returned.

Parameter	Meaning
urn:uuid:34268e47-fdf5-41a6-ba33-82133c465248	On-Demand document entry types are returned. This is the on-demand created Community Medication List document.
urn:uuid:7edca82f-054d-47f2-a032-9b2a5b5186c1 See note <sup>35</sup>	Stable document entry types are returned. Previously persisted snapshots of on-demand created Community Medication List document.

**3.1.4.1.2.1.2 Query result examples**

1835 This section provides example query results to demonstrate how the queries of this transaction shall function.

**3.1.4.1.2.1.2.1 Examples for standard queries**

1840 For the examples for the standard queries, assume the following situation of persisted documents in the Prescription-, Pharmaceutical Advice-, Dispensed Medication and Administered Medication repositories:

---

<sup>35</sup> Note: This parameter is applicable only if the “Persistence of Retrieved Documents” Option is supported.



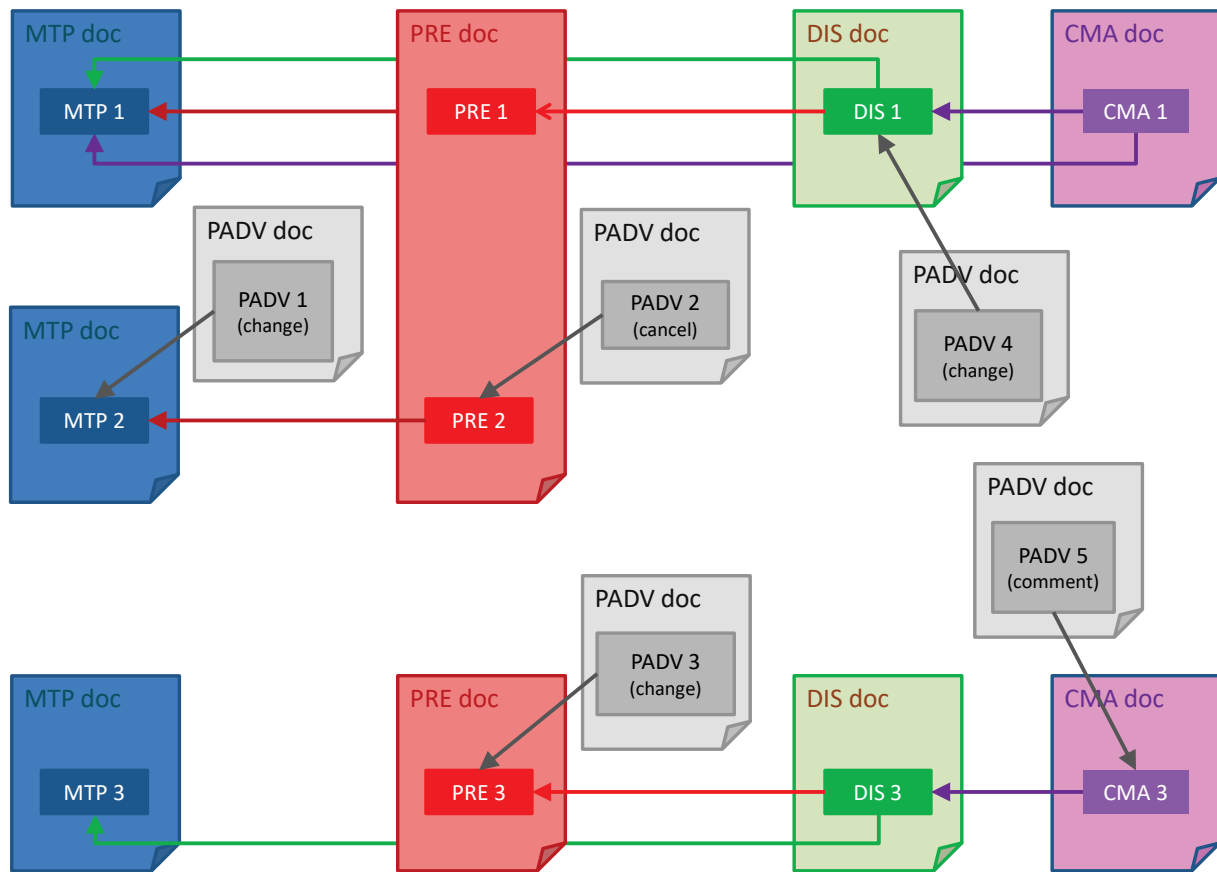

**Figure 3.1.4.1.2.1.2.1-1: Example of documents persisted in repositories (for standard queries)**

1845 **Note 1:** The example is designed in a scenario “without validation step” and therefore in this example setting the PADV are all related to MTP-, PRE-, DIS- or CMA items representing changes, cancellations, etc.

**Note 2:** Medication Treatment Plan Items (documents) are optional and may not be present. They are included in the examples for describing the situation where a Medication Treatment Planner is being used.

1850 **3.1.4.1.2.1.2.1.1 Examples for FindMedicationTreatmentPlans**

Used Query Parameters:

- Patient ID
- Document Status

This is what should be returned by the query:

1855

Returned XSDDocumentEntries		Notes
MTP (Business rule 1)	Related documents	
MTP 1	Business rule 2: - Business rule 3: PRE 1 Business rule 4: DIS 1 Business rule 5: CMA 1 Business rule 6: PADV 4	
MTP 2	Business rule 2: PADV 1 Business rule 3: PRE 2 Business rule 4: - Business rule 5: - Business rule 6: PADV 2	
MTP 3	Business rule 2: - Business rule 3: PRE 3 Business rule 4: DIS 3 Business rule 5: CMA 3 Business rule 6: PADV 3, PADV 5	Although PRE 3 is not directly referencing MTP 3, PRE 3 and its related document PADV 3 are returned, because there is an <u>indirect</u> relationship to MTP 3 via DIS 3 item, which is directly referencing MTP 3.

### 3.1.4.1.2.1.2.1.2 Examples for FindPrescriptions

Used Query Parameters:

- Patient ID
- Document Status

1860

This is what should be returned by the query:

Returned XSDDocumentEntries		Notes
PRE (Business rule 1)	Related documents	
PRE 1	Business rule 2: - Business rule 3: MTP 1 Business rule 4: DIS 1 Business rule 5: CMA 1 Business rule 6: PADV 4	

Returned XSDDocumentEntries		Notes
PRE (Business rule 1)	Related documents	
PRE 2	Business rule 2: PADV 2 Business rule 3: MTP 2 Business rule 4: - Business rule 5: - Business rule 6: PADV 1	
PRE 3	Business rule 2: PADV 3 Business rule 3: MTP 3 Business rule 4: DIS 3 Business rule 5: CMA 3 Business rule 6: PADV 3, PADV 5	

1865 **3.1.4.1.2.1.2.1.3 Examples for FindDispenses**

Used Query Parameters:

- Patient ID
- Document Status

1870 This is what should be returned by the query:

Returned XSDDocumentEntries		Notes
DIS (Business rule 1)	Related documents	
DIS 1	Business rule 2: PADV 4 Business rule 3: MTP 1 Business rule 4: PRE 1 Business rule 5: CMA 1 Business rule 6: -	
DIS 3	Business rule 2: - Business rule 3: MTP 3 Business rule 4: PRE 3 Business rule 5: CMA 3 Business rule 6: PADV 3, PADV 5	

**3.1.4.1.2.1.2.1.4 Examples for FindMedicationAdministrations**

Used Query Parameters:

---

1875

- Patient ID
- Document Status

This is what should be returned by the query:

Returned XDSDocumentEntries		Notes
CMA (Business rule 1)	Related documents	
CMA 1	Business rule 2: - Business rule 3: MTP 1 Business rule 4: PRE 1 Business rule 5: DIS 1 Business rule 6: PADV 4	
CMA 3	Business rule 2: PADV 5 Business rule 3: MTP 3 Business rule 4: PRE 3 Business rule 5: DIS 3 Business rule 6: PADV 3	

1880

### 3.1.4.1.2.1.2.2 Examples for specialized queries

For the examples for the specialized queries, assume the following situation of persisted documents in the Prescription-, Pharmaceutical Advice-, Dispensed Medication and Administered Medication repositories:

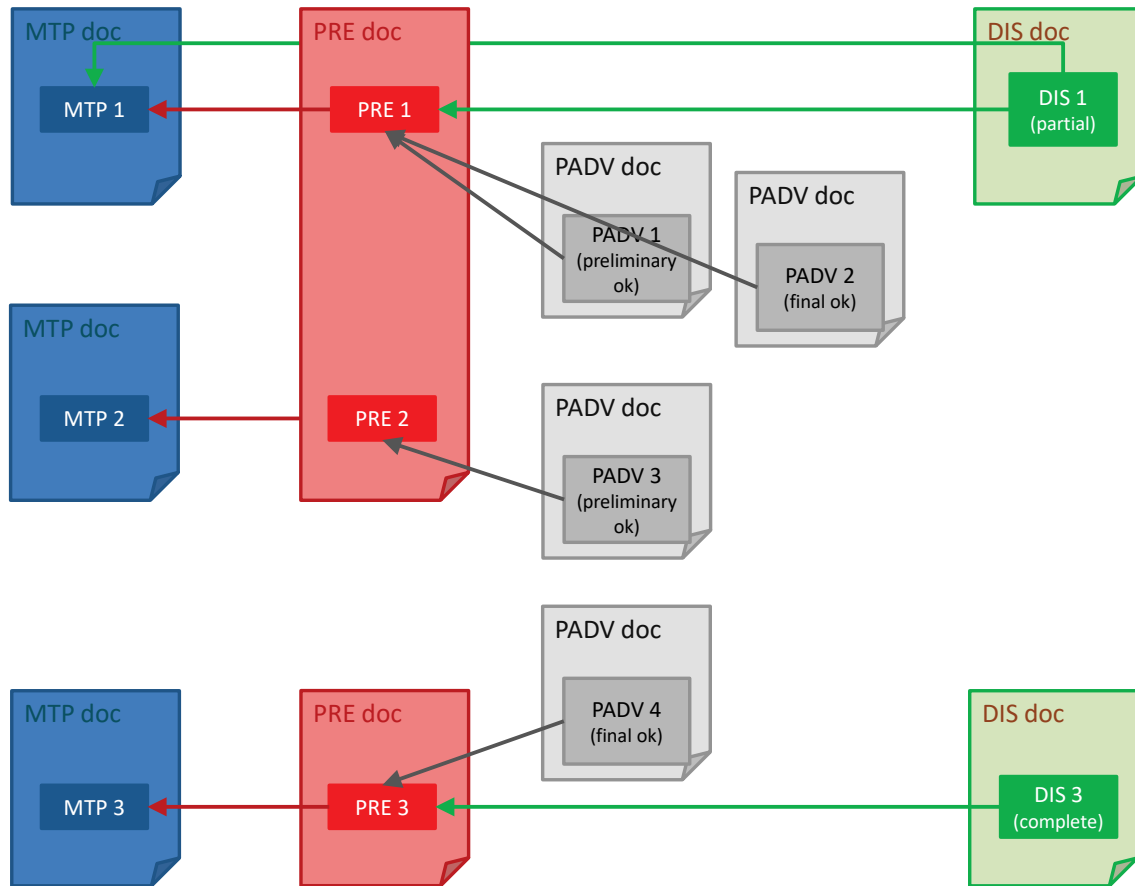

1885

**Figure 3.1.4.1.2.1.2.2-1: Example of documents persisted in repositories (for specialized queries)**

Note 1: The example is designed in a scenario “with validation step” and therefore in this example setting all PADV representing changes, cancellations, etc. are left away in the interest of simplicity.

1890

Note 2: Medication Treatment Plan Items (documents) are optional and may not be present. They are included in the examples for describing the situation where a Medication Treatment Plan Planner is being used.

### 3.1.4.1.2.1.2.2.1 Examples for FindPrescriptionsForValidation

1895

Used Query Parameters:

- Patient ID
- Document Status

This is what should be returned by the query:

Returned XSDDocumentEntries		Notes
PRE (Business rule 1)	Related documents	
PRE 2	Business rule 2: PADV 3 Business rule 3: MTP 2 Business rule 4: - Business rule 5: - Business rule 6: -	PRE 2 is returned, because PADV is “preliminary” only (same as if no PADV was present). Only PRE 2 is returned, since all other PREs are already validated.

1900

### 3.1.4.1.2.1.2.2 Examples for FindPrescriptionsForDispense

Used Query Parameters:

- Patient ID
- Document Status

1905

This is what should be returned by the query:

Returned XSDDocumentEntries		Notes
PRE (Business rule 1)	Related documents	
PRE 1	Business rule 2: PADV 1, PADV 2 Business rule 3: MTP 1 Business rule 4: DIS 1 Business rule 5: - Business rule 6: -	Only PRE 1 is returned, since all other PREs are either not validated yet (PRE 2) or already fully dispensed (PRE 3).

### 3.1.4.1.2.2 Stored Query IDs

1910 The Registry Stored Query [ITI-18] transaction defines several kinds of Stored Queries (FindDocuments, FindSubmissionSets, etc.).

The PHARM-1 transaction has to provide a different set of Stored Queries. They are assigned the following Query IDs. These IDs are used in the AdhocQueryRequest to reference queries stored on the Community Pharmacy Manager. Query IDs are in UUID format (RFC4122). An error shall be returned when an unsupported stored query ID is received.

1915

Query Name	Query ID
FindMedicationTreatmentPlans	urn:uuid:c85f5ade-81c1-44b6-8f7c-48b9cd6b9489
FindPrescriptions	urn:uuid:0e6095c5-dc3d-47d9-a219-047064086d92
FindDispenses	urn:uuid:ac79c7c7-f21b-4c88-ab81-57e4889e8758
FindMedicationAdministrations	urn:uuid:fdbe8fb8-7b5c-4470-9383-8abc7135f462
FindPrescriptionsForValidation	urn:uuid:c1a43b20-0254-102e-8469-a6af440562e8
FindPrescriptionsForDispense	urn:uuid:c875eb9c-0254-102e-8469-a6af440562e8
FindMedicationList	urn:uuid:80ebbd83-53c1-4453-9860-349585962af6

### 3.1.4.1.2.3 Web Services Transport

The Registry Stored Query [ITI-18] transaction defines the transmission using Web Services.

1920 This section describes the differences of the [PHARM-1] transaction to the [ITI-18] transaction.

**IHE-WSP201) The attribute /wsdl:definitions/@name shall be “CommunityPharmacyManager”.**

The following WSDL naming conventions shall apply:

1925 wsdl:definitions/@name="CommunityPharmacyManager":  
 query message -> "QueryPharmacyDocuments\_Message"  
 query response -> "QueryPharmacyDocuments\_Response\_Message"  
 portType -> "CommunityPharmacyManager\_PortType"  
 operation -> "QueryPharmacyDocuments"  
 1930 SOAP 1.2 binding -> "CommunityPharmacyManager\_Binding\_Soap12"  
 SOAP 1.2 port -> "CommunityPharmacyManager\_Port\_Soap12"

**IHE-WSP202) The targetNamespace of the WSDL shall be “urn:ihe:iti:xds-b:2007”**

These are the requirements for the Registry Stored Query transaction presented in the order in which they would appear in the WSDL definition:

- 1935
- The following types shall be imported (xsd:import) in the /definitions/types section:
    - namespace="urn:oasis:names:tc:ebxml-regrep:xsd:query:3.0",  
 schemaLocation="query.xsd"

- 1940
  - The /definitions/message/part/@element attribute of the Find Prescriptions Request message shall be defined as “query:AdhocQueryRequest”
  - The /definitions/message/part/@element attribute of the Find Prescriptions Response message shall be defined as “query:AdhocQueryResponse”
  - The /definitions/portType/operation/input/@wsaw:Action attribute for the Find Prescriptions Request message shall be defined as “urn:ihe:pharm:cmpd:2010:QueryPharmacyDocuments”
- 1945
  - The /definitions/portType/operation/output/@wsaw:Action attribute for the Find Prescriptions Response message shall be defined as “urn:ihe:pharm:cmpd:2010:QueryPharmacyDocumentsResponse”
  - The /definitions/binding/operation/soap12:operation/@soapAction attribute should be defined as “urn:ihe:pharm:cmpd:2010:QueryPharmacyDocuments”
- 1950 The following WSDL fragment shows an example of Query Pharmacy Documents transaction definition:

```

1955 <?xml version="1.0" encoding="utf-8"?>
1960 <definitions ...>
1965   ...
1970   <types>
1975     <xsd:schema elementFormDefault="qualified" targetNamespace="urn:ihe:iti:xds-b:2007">
1980       <xsd:import
         namespace="urn:oasis:names:tc:ebxml-regrep:xsd:query:3.0"
         schemaLocation="schema\query.xsd"/>
       ...
     </xsd:schema>
   </types>
   <message name="QueryPharmacyDocuments_Message">
     <documentation>Query Pharmacy Documents</documentation>
     <part name="body" element="query:AdhocQueryRequest"/>
   </message>
   <message name="QueryPharmacyDocumentsResponse_Message">
     <documentation>Query Pharmacy Documents Response</documentation>
     <part name="body" element="query:AdhocQueryResponse"/>
   </message>
   ...
   <portType name="CommunityPharmacyManager_PortType">
     <operation name="CommunityPharmacyManager_QueryPharmacyDocuments">
       <input message="ihe:QueryPharmacyDocuments_Message"
         wsaw:Action="urn:ihe:pharm:cmpd:2010:QueryPharmacyDocuments"/>
       <output message="ihe:RegistryStoredQueryResponse_Message"
         wsaw:Action="urn:ihe:pharm:cmpd:2010:QueryPharmacyDocumentsResponse"/>
     </operation>
     ...
   </portType>
   ...
 </definitions>

```



1985 **3.1.4.1.2.3.1 Sample SOAP Messages**

The samples in the following two sections show a typical SOAP request and its relative SOAP response.

**3.1.4.1.2.3.1.1 Sample Query Pharmacy Documents SOAP Request**

1990

```
<s:Envelope xmlns:s=http://www.w3.org/2003/05/soap-envelope
  xmlns:a="http://www.w3.org/2005/08/addressing">
  <s:Header>
    <a:Action s:mustUnderstand="1">urn:ihe:pharm:cmpd:2010:QueryPharmacyDocuments</a:Action>
    <a:MessageID>urn:uuid:def119ad-dc13-49c1-a3c7-e3742531f9b3</a:MessageID>
    <a:ReplyTo s:mustUnderstand="1">
      <a:Address>http://www.w3.org/2005/08/addressing/anonymous</a:Address>
    </a:ReplyTo>
    <a:To>http://localhost/service/CommunityPharmacyManager.svc</a:To>
  </s:Header>
  <s:Body>
    <query:AdhocQueryRequest>
      :
      see Sample Query Request below
      :
    </query:AdhocQueryRequest>
  </s:Body>
</s:Envelope>
```

1995

2000

2005

**3.1.4.1.2.3.1.2 Sample Query Pharmacy Documents SOAP Response**

2010

```
<s:Envelope xmlns:s=http://www.w3.org/2003/05/soap-envelope
  xmlns:a="http://www.w3.org/2005/08/addressing">
  <s:Header>
    <a:Action
s:mustUnderstand="1">urn:ihe:pharm:cmpd:2010:QueryPharmacyDocumentsResponse</a:Action>
    <a:RelatesTo>urn:uuid:def119ad-dc13-49c1-a3c7-e3742531f9b3</a:RelatesTo>
  </s:Header>
  <s:Body>
    <query:AdhocQueryResponse>
      :
      see Sample Query Response below
      :
    </query:AdhocQueryResponse>
  </s:Body>
</s:Envelope>
```

2015

2020

2025 **3.1.4.1.3 Expected Actions**

The Community Pharmacy Manager shall do the same actions as described for the Document Registry in the Registry Stored Query [ITI-18] transaction.

**3.1.4.1.3.1 Sample Query Request**

This example query specifies:

2030

- The FindPrescriptionsForValidation query (id attribute of AdhocQuery element)

- patientID st3498702^^^&1.3.6.1.4.1.21367.2005.3.7&ISO
- Return Approved documents only
- Time range (creation time) 200412252300 to 200501010800

2035 Note that ebRS 3.0 specifies the use of Slot to specify name/value(s) pairs as parameters to a Stored Query.

Note: query parameter names are highlighted for readability.

```
2040 <query:AdhocQueryRequest
  xmlns:xsi="http://www.w3.org/2001/XMLSchema-instance"
  xmlns:query="urn:oasis:names:tc:ebxml-regrep:xsd:query:3.0"
  xmlns:rim="urn:oasis:names:tc:ebxml-regrep:xsd:rim:3.0"
  xmlns:rs="urn:oasis:names:tc:ebxml-regrep:xsd:rs:3.0">
2045 <query:ResponseOption returnComposedObjects="true" returnType="LeafClass"/>
  <rim:AdhocQuery id="urn:uuid:c1a43b20-0254-102e-8469-a6af440562e8">
    <rim:Slot name="$XDSDocumentEntryPatientId">
      <rim:ValueList>
        <rim:Value>'st3498702^^^&1.3.6.1.4.1.21367.2005.3.7&ISO'</rim:Value>
      </rim:ValueList>
    </rim:Slot>
2050 <rim:Slot name="$XDSDocumentEntryStatus">
      <rim:ValueList>
        <rim:Value>('urn:oasis:names:tc:ebxml-regrep:StatusType:Approved')</rim:Value>
      </rim:ValueList>
    </rim:Slot>
2055 <rim:Slot name="$XDSDocumentEntryCreationTimeFrom">
      <rim:ValueList>
        <rim:Value>200412252300</rim:Value>
      </rim:ValueList>
    </rim:Slot>
2060 <rim:Slot name="$XDSDocumentEntryCreationTimeTo">
      <rim:ValueList>
        <rim:Value>200501010800</rim:Value>
      </rim:ValueList>
    </rim:Slot>
2065 </rim:AdhocQuery>
  </query:AdhocQueryRequest>
```

### 3.1.4.1.3.2 Sample Query Response

2070 This sample query response corresponds to the above query. Note that the query response message is coded in version 3.0 ebRIM and ebRS. This sample response and the ebXML Registry version 3.0 schema files are available online. The Implementation Guide found at [http://wiki.ihe.net/index.php?title=ITI\\_Implementation\\_Guide](http://wiki.ihe.net/index.php?title=ITI_Implementation_Guide) contains such supplemental material.

```
2075 <?xml version="1.0" encoding="UTF-8"?>
```

# IHE Pharmacy Technical Framework Supplement – Community Medication Prescription and Dispense (CMPD)

```
<AdhocQueryResponse
xmlns="urn:oasis:names:tc:ebxml-regrep:xsd:query:3.0"
xmlns:rim="urn:oasis:names:tc:ebxml-regrep:xsd:rim:3.0"
xmlns:xsi=http://www.w3.org/2001/XMLSchema-instance
2080 xsi:schemaLocation="urn:oasis:names:tc:ebxml-regrep:xsd:query:3.0 file:/query.xsd"
status="urn:oasis:names:tc:ebxml-regrep:ResponseStatusType:Success">
  <rim:RegistryObjectList>
    <rim:ExtrinsicObject
2085 xmlns:q="urn:oasis:names:tc:ebxml-regrep:xsd:query:3.0"
xmlns:rim="urn:oasis:names:tc:ebxml-regrep:xsd:rim:3.0"
id="urn:uuid:08a15a6f-5b4a-42de-8f95-89474f83abdf"
isOpaque="false"
mimeType="text/xml"
2090 objectType="urn:uuid:7edca82f-054d-47f2-a032-9b2a5b5186c1"
status="urn:oasis:names:tc:ebxml-regrep:StatusType:Approved">
  <rim:Slot name="URI">
    <rim:ValueList>
      <rim:Value>http://localhost:8080/XDS/Repository/08a15a6f-5b4a-42de-8f95-
2095 89474f83abdf.xml</rim:Value>
    </rim:ValueList>
  </rim:Slot>
  <rim:Slot name="authorInstitution">
    <rim:ValueList>
      <rim:Value>Some Hospital^^^^^^^^^1.2.3.4.5.6.7.8.9.1789.45</rim:Value>
2100 </rim:ValueList>
  </rim:Slot>
  <rim:Slot name="creationTime">
    <rim:ValueList>
      <rim:Value>200412261119</rim:Value>
2105 </rim:ValueList>
  </rim:Slot>
  <rim:Slot name="hash">
    <rim:ValueList>
      <rim:Value>4cf4f82d78b5e2aac35c31bca8cb79fe6bd6a41e</rim:Value>
2110 </rim:ValueList>
  </rim:Slot>
  <rim:Slot name="languageCode">
    <rim:ValueList>
      <rim:Value>en-us</rim:Value>
2115 </rim:ValueList>
  </rim:Slot>
  <rim:Slot name="serviceStartTime">
    <rim:ValueList>
      <rim:Value>200412230800</rim:Value>
2120 </rim:ValueList>
  </rim:Slot>
  <rim:Slot name="serviceStopTime">
    <rim:ValueList>
      <rim:Value>200412230801</rim:Value>
2125 </rim:ValueList>
  </rim:Slot>
  <rim:Slot name="size">
    <rim:ValueList>
      <rim:Value>54449</rim:Value>
2130 </rim:ValueList>
  </rim:Slot>
```

# IHE Pharmacy Technical Framework Supplement – Community Medication Prescription and Dispense (CMPD)

```
2135     <rim:Slot name="sourcePatientId">
        <rim:ValueList>
          <rim:Value>jd12323^^^wsh</rim:Value>
        </rim:ValueList>
      </rim:Slot>
      <rim:Slot name="sourcePatientInfo">
        <rim:ValueList>
          <rim:Value>PID-3|pid1^^^domain</rim:Value>
2140     <rim:Value>PID-5|Doe^John^^^</rim:Value>
          <rim:Value>PID-7|19560527</rim:Value>
          <rim:Value>PID-8|M</rim:Value>
          <rim:Value>PID-11|100 Main St^^Metropolis^Il^44130^USA</rim:Value>
        </rim:ValueList>
2145     </rim:Slot>
      <rim:Name>
        <rim:LocalizedString charset="UTF-8" value="Community Prescription"
xml:lang="en-us"/>
      </rim:Name>
2150     <rim:Description/>
      <rim:Classification
classificationScheme="urn:uuid:41a5887f-8865-4c09-adf7-e362475b143a"
classifiedObject="urn:uuid:08a15a6f-5b4a-42de-8f95-89474f83abdf"
id="urn:uuid:ac872fc0-1c6e-439f-84d1-f76770a0ccdf"
2155     nodeRepresentation="57833-6"
objectType="Urn:oasis:names:tc:ebxml-regrep:ObjectType:RegistryObject:Classification">
      <rim:Slot name="codingScheme">
        <rim:ValueList>
          <rim:Value>Connect-a-thon classCodes</rim:Value>
2160     </rim:ValueList>
        </rim:Slot>
      <rim:Name>
        <rim:LocalizedString charset="UTF-8" value="Prescriptions" xml:lang="en-us"/>
      </rim:Name>
2165     <rim:Description/>
      </rim:Classification>
      <rim:Classification
classificationScheme="urn:uuid:f4f85eac-e6cb-4883-b524-f2705394840f"
classifiedObject="urn:uuid:08a15a6f-5b4a-42de-8f95-89474f83abdf"
2170     id="urn:uuid:fla8c8e4-3593-4777-b7e0-8b0773378705"
nodeRepresentation="N"
objectType="Urn:oasis:names:tc:ebxml-regrep:ObjectType:RegistryObject:Classification">
      <rim:Slot name="codingScheme">
        <rim:ValueList>
          <rim:Value>Connect-a-thon confidentialityCodes</rim:Value>
2175     </rim:ValueList>
        </rim:Slot>
      <rim:Name>
        <rim:LocalizedString charset="UTF-8" value="Normal" xml:lang="en-us"/>
2180     </rim:Name>
      <rim:Description/>
      </rim:Classification>
      <rim:Classification
classificationScheme="urn:uuid:a09d5840-386c-46f2-b5ad-9c3699a4309d"
classifiedObject="urn:uuid:08a15a6f-5b4a-42de-8f95-89474f83abdf"
2185     id="urn:uuid:b6e49c73-96c8-4058-8c95-914d83bd262a"
nodeRepresentation="urn:ihe:pharm:pre:2010"
```

# IHE Pharmacy Technical Framework Supplement – Community Medication Prescription and Dispense (CMPD)

```
2190 objectType="Urn:oasis:names:tc:ebxml-regrep:ObjectType:RegistryObject:Classification">
    <rim:Slot name="codingScheme">
      <rim:ValueList>
        <rim:Value>Connect-a-thon formatCodes</rim:Value>
      </rim:ValueList>
    </rim:Slot>
    <rim:Name>
2195     <rim:LocalizedString charset="UTF-8" value="Community Prescription"
xml:lang="en-us"/>
    </rim:Name>
    <rim:Description/>
    </rim:Classification>
2200 <rim:Classification
classificationScheme="urn:uuid:f33fb8ac-18af-42cc-ae0e-ed0b0bdb91e1"
classifiedObject="urn:uuid:08a15a6f-5b4a-42de-8f95-89474f83abdf"
id="urn:uuid:61e2b376-d74a-4984-ac21-dcd0b8890f9d"
nodeRepresentation="Emergency Department"
2205 objectType="Urn:oasis:names:tc:ebxml-regrep:ObjectType:RegistryObject:Classification">
    <rim:Slot name="codingScheme">
      <rim:ValueList>
        <rim:Value>Connect-a-thon healthcareFacilityTypeCodes</rim:Value>
      </rim:ValueList>
2210    </rim:Slot>
    <rim:Name>
      <rim:LocalizedString charset="UTF-8" value="Emergency Department"
xml:lang="en-us"/>
    </rim:Name>
    <rim:Description/>
2215    </rim:Classification>
    <rim:Classification
classificationScheme="urn:uuid:cccf5598-8b07-4b77-a05e-ae952c785ead"
classifiedObject="urn:uuid:08a15a6f-5b4a-42de-8f95-89474f83abdf"
2220 id="urn:uuid:fb7677c5-c42f-485d-9010-dce0f3cd4ad5"
nodeRepresentation="Cardiology"
objectType="Urn:oasis:names:tc:ebxml-regrep:ObjectType:RegistryObject:Classification">
    <rim:Slot name="codingScheme">
      <rim:ValueList>
        <rim:Value>Connect-a-thon practiceSettingCodes</rim:Value>
      </rim:ValueList>
2225    </rim:Slot>
    <rim:Name>
      <rim:LocalizedString charset="UTF-8" value="Cardiology" xml:lang="en-us"/>
2230    </rim:Name>
    <rim:Description/>
    </rim:Classification>
    <rim:Classification
classificationScheme="urn:uuid:f0306f51-975f-434e-a61c-c59651d33983"
classifiedObject="urn:uuid:08a15a6f-5b4a-42de-8f95-89474f83abdf"
2235 id="urn:uuid:0a8a8ed9-8be5-4a63-9b68-a511adee8ed5"
nodeRepresentation="57833-6"
objectType="Urn:oasis:names:tc:ebxml-regrep:ObjectType:RegistryObject:Classification">
    <rim:Slot name="codingScheme">
      <rim:ValueList>
        <rim:Value>LOINC</rim:Value>
      </rim:ValueList>
2240    </rim:Slot>
```

```

2245     <rim:Name>
          <rim:LocalizedString charset="UTF-8" value="Prescriptions" xml:lang="en-us"/>
        </rim:Name>
        <rim:Description/>
      </rim:Classification>
      <rim:ExternalIdentifier
2250 id="urn:uuid:db9f4438-ffff-435f-9d34-d76190728637"
      registryObject="urn:uuid:08a15a6f-5b4a-42de-8f95-89474f83abdf"
      identificationScheme="urn:uuid:58a6f841-87b3-4a3e-92fd-a8ffeff98427"
      objectType="ExternalIdentifier"
2255 value="st3498702^^^&1.3.6.1.4.1.21367.2005.3.7&ISO">
          <rim:Name>
            <rim:LocalizedString charset="UTF-8"
2260 value="XDSDocumentEntry.patientId" xml:lang="en-us"/>
          </rim:Name>
          <rim:Description/>
        </rim:ExternalIdentifier>
        <rim:ExternalIdentifier
2265 id="urn:uuid:c3fcbf0e-9765-4f5b-abaa-b37ac8ff05a5"
      registryObject="urn:uuid:08a15a6f-5b4a-42de-8f95-89474f83abdf"
      identificationScheme="urn:uuid:2e82c1f6-a085-4c72-9da3-8640a32e42ab"
      objectType="ExternalIdentifier" value="1.3.6.1.4.1.21367.2005.3.99.1.1010">
          <rim:Name>
            <rim:LocalizedString charset="UTF-8"
2270 value="XDSDocumentEntry.uniqueId" xml:lang="en-us"/>
          </rim:Name>
          <rim:Description/>
        </rim:ExternalIdentifier>
      </rim:ExtrinsicObject>
    </rim:RegistryObjectList>
  </AdhocQueryResponse>

```

2275

### 3.1.5 Security Considerations

Relevant XDS Affinity Domain Security background is discussed in the XDS Security Considerations Section (see ITI TF-1: 10.7).

#### 3.1.5.1 Security Audit Considerations

2280 The actors involved shall record audit events according to the following:

##### 3.1.5.1.1 Querying actor audit message:

	Field Name	Opt	Value Constraints
Event AuditMessage/ EventIdentific ation	EventID	M	EV(110112, DCM, "Query")
	EventActionCode	M	"E" (Execute)
	EventDateTime	M	not specialized
	EventOutcomeIndicator	M	not specialized
	EventTypeCode	M	EV("PHARM-1", "IHE Transactions", "Query Pharmacy Documents")

IHE Pharmacy Technical Framework Supplement – Community Medication Prescription and Dispense (CMPD)

	Field Name	Opt	Value Constraints
<b>Source (Document Consumer) (1)</b>			
<b>Human Requestor (0..n)</b>			
<b>Destination (Document Registry) (1)</b>			
<b>Audit Source (Document Consumer) (1)</b>			
<b>Patient (0..1)</b>			
<b>Query Parameters(1)</b>			

Where:

<b>Source</b> AuditMessage/ ActiveParticipant	UserID	M	The content of the <wsa:ReplyTo/> element.
	AlternativeUserID	M	the process ID as used within the local operating system in the local system logs.
	<i>UserName</i>	<i>U</i>	<i>not specialized</i>
	UserIsRequestor	M	“true”
	RoleIDCode	M	EV(110153, DCM, “Source”)
	NetworkAccessTypeCode	M	“1” for machine (DNS) name, “2” for IP address
	NetworkAccessPointID	M	The machine name or IP address, as specified in RFC3881.

<b>Human Requestor (if known)</b> AuditMessage/ ActiveParticipant	UserID	M	Identity of the human that initiated the transaction.
	<i>AlternativeUserID</i>	<i>U</i>	<i>not specialized</i>
	<i>UserName</i>	<i>U</i>	<i>not specialized</i>
	UserIsRequestor	M	“true”
	RoleIDCode	U	Access Control role(s) the user holds that allows this transaction.
	<i>NetworkAccessTypeCode</i>	<i>NA</i>	
	<i>NetworkAccessPointID</i>	<i>NA</i>	

2285

<b>Destination</b> AuditMessage/ ActiveParticipant	UserID	M	SOAP endpoint URI.
	<i>AlternativeUserID</i>	<i>U</i>	<i>not specialized</i>
	<i>UserName</i>	<i>U</i>	<i>not specialized</i>
	UserIsRequestor	M	“false”
	RoleIDCode	M	EV(110152, DCM, “Destination”)
	NetworkAccessTypeCode	M	“1” for machine (DNS) name, “2” for IP address
	NetworkAccessPointID	M	The machine name or IP address, as specified in RFC3881.

IHE Pharmacy Technical Framework Supplement – Community Medication Prescription and Dispense (CMPD)

<b>Audit Source</b> AuditMessage/ AuditSourceIdentifi- cation	<i>AuditSourceID</i>	<i>U</i>	<i>not specialized</i>
	<i>AuditEnterpriseSiteID</i>	<i>U</i>	<i>not specialized</i>
	<i>AuditSourceTypeCode</i>	<i>U</i>	<i>not specialized</i>

<b>Patient</b> (AuditMessage/ ParticipantObjectIdentifi- cation)	ParticipantObjectTypeCode	M	“1” (Person)
	ParticipantObjectTypeCodeRole	M	“1” (Patient)
	<i>ParticipantObjectDataLifeCycle</i>	<i>U</i>	<i>not specialized</i>
	ParticipantObjectIDTypeCode	M	EV(2, RFC-3881, “Patient Number”)
	<i>ParticipantObjectSensitivity</i>	<i>U</i>	<i>not specialized</i>
	ParticipantObjectID	M	The patient ID in HL7 CX format.
	<i>ParticipantObjectName</i>	<i>U</i>	<i>not specialized</i>
	<i>ParticipantObjectQuery</i>	<i>U</i>	<i>not specialized</i>
<i>ParticipantObjectDetail</i>	<i>U</i>	<i>not specialized</i>	

Query Parameters (AuditMessage/ ParticipantObjectIdentifi- cation)	ParticipantObjectTypeCode	M	“2” (system object)
	ParticipantObjectTypeCodeRole	M	“24” (query)
	<i>ParticipantObjectDataLifeCycle</i>	<i>U</i>	<i>not specialized</i>
	ParticipantObjectIDTypeCode	M	EV(“PHARM-1”, “IHE Transactions”, “ <b>Query Pharmacy Documents</b> ”)
	<i>ParticipantObjectSensitivity</i>	<i>U</i>	<i>not specialized</i>
	ParticipantObjectID	M	Stored Query ID (UUID)
	ParticipantObjectName	C	If known the value of <ihe:HomeCommunityId/>
	ParticipantObjectQuery	M	the AdhocQueryRequest, base64 encoded.
	ParticipantObjectDetail	C	The ParticipantObjectDetail element may occur more than once. In one element, set “QueryEncoding” as the value of the attribute type, Set the attribute value to the character encoding, such as “UTF-8”, used to encode the ParticipantObjectQuery before base64 encoding. In another element, set “urn:ihe:iti:xca:2010:homeCommunityId” as the value of the attribute type and the value of the homeCommunityID as the value of the attribute value, if known.



2290

### 3.1.5.1.2 Community Pharmacy Manager audit message:

	Field Name	Opt	Value Constraints
<b>Event</b> AuditMessage/ EventIdentification	EventID	M	EV(110112, DCM, “Query”)
	EventActionCode	M	“E” (Execute)
	<i>EventDateTime</i>	M	<i>not specialized</i>
	<i>EventOutcomeIndicator</i>	M	<i>not specialized</i>
	EventTypeCode	M	EV(“PHARM-1”, “IHE Transactions”, “Query Pharmacy Documents”)
<b>Source (Document Consumer) (1)</b>			
<b>Destination (Document Registry) (1)</b>			
<b>Audit Source (Document Registry) (1)</b>			
<b>Patient (0..1)</b>			
<b>Query Parameters(1)</b>			

Where:

<b>Source</b> AuditMessage/ ActiveParticipant	UserID	M	The content of the <wsa:ReplyTo/> element.
	AlternativeUserID	U	<i>not specialized</i>
	<i>UserName</i>	U	<i>not specialized</i>
	UserIsRequestor	M	“true”
	RoleIDCode	M	EV(110153, DCM, “Source”)
	NetworkAccessPointTypeCode	M	“1” for machine (DNS) name, “2” for IP address
	NetworkAccessPointID	M	The machine name or IP address, as specified in RFC3881.

<b>Destination</b> AuditMessage/ ActiveParticipant	UserID	M	SOAP endpoint URI.
	<i>AlternativeUserID</i>	M	the process ID as used within the local operating system in the local system logs.
	<i>UserName</i>	U	<i>not specialized</i>
	UserIsRequestor	M	“false”
	RoleIDCode	M	EV(110152, DCM, “Destination”)
	NetworkAccessPointTypeCode	M	“1” for machine (DNS) name, “2” for IP address
	NetworkAccessPointID	M	The machine name or IP address, as specified in RFC3881.

<b>Audit Source</b> AuditMessage/ AuditSourceIdentification	<i>AuditSourceID</i>	U	<i>not specialized</i>
	<i>AuditEnterpriseSiteID</i>	U	<i>not specialized</i>
	<i>AuditSourceTypeCode</i>	U	<i>not specialized</i>

2295

<b>Patient</b> (AuditMessage/ ParticipantObjectIdentification)	ParticipantObjectTypeCode	M	“1” (Person)
	ParticipantObjectTypeCodeRole	M	“1” (Patient)
	<i>ParticipantObjectDataLifeCycle</i>	<i>U</i>	<i>not specialized</i>
	ParticipantObjectIDTypeCode	M	EV(2, RFC-3881, “Patient Number”)
	<i>ParticipantObjectSensitivity</i>	<i>U</i>	<i>not specialized</i>
	ParticipantObjectID	M	The patient ID in HL7 CX format.
	<i>ParticipantObjectName</i>	<i>U</i>	<i>not specialized</i>
	<i>ParticipantObjectQuery</i>	<i>U</i>	<i>not specialized</i>
<i>ParticipantObjectDetail</i>	<i>U</i>	<i>not specialized</i>	

<b>Query Parameters</b> (AuditMessage/ ParticipantObjectIdentification)	ParticipantObjectTypeCode	M	“2” (system object)
	ParticipantObjectTypeCodeRole	M	“24” (query)
	<i>ParticipantObjectDataLifeCycle</i>	<i>U</i>	<i>not specialized</i>
	ParticipantObjectIDTypeCode	M	EV(“PHARM-1”, “IHE Transactions”, “Query Pharmacy Documents”)
	<i>ParticipantObjectSensitivity</i>	<i>U</i>	<i>not specialized</i>
	ParticipantObjectID	M	Stored Query ID (UUID)
	ParticipantObjectName	C	If known the value of <ihe:HomeCommunityId/>
	ParticipantObjectQuery	M	the AdhocQueryRequest, base64 encoded.
	ParticipantObjectDetail	C	The ParticipantObjectDetail element may occur more than once. In one element, set “QueryEncoding” as the value of the attribute type, Set the attribute value to the character encoding, such as “UTF-8”, used to encode the ParticipantObjectQuery before base64 encoding. In another element, set “urn:ihe:iti:xca:2010:homeCommunityId” as the value of the attribute type and the value of the homeCommunityID as the value of the attribute value, if known.

### 3.1.5.1.(z) Actor Specific Security Considerations

No information available yet.

## 2300 **3.2 Query Pharmacy Documents over MHD [PHARM-5]**

2305 This transaction defines how a querying actor has to query the Community Pharmacy Manager for Community Medication Treatment Plans (MTP), Community Prescriptions (PRE), Community Dispenses (DIS) and Administrations (CMA) and their related documents over MHD (i.e., using RESTful interface). The behavior of PHARM-5 is identical to the behavior of PHARM-1 and thus only differences with PHARM-1 are described here. PHARM-5 operations have a one-to-one mapping onto PHARM-1 queries. For a detailed description of the behavior of each operation, refer to the corresponding query of PHARM-1 in section 3.1.

2310 This transaction is very similar to the concept of the Find Document References [ITI-67] transaction in the MHD Integration Profile of the ITI Technical Framework with XDS on FHIR and Comprehensive Metadata options.

### **3.2.1 Scope**

The Query Pharmacy Documents transaction supports the following operations:

- 2315 • **\$find-medication-treatment-plans (if „Medication Treatment Planning“ Option is supported)**  
Find planned medication documents and their related documents. Equivalent to FindMedicationTreatmentPlans query of PHARM-1
- 2320 • **\$find-prescriptions**  
Find prescriptions and their related documents. Equivalent to FindPrescriptions query of PHARM-1
- 2325 • **\$find-dispenses**  
Find dispense documents and their related documents. Equivalent to FindDispenses query of PHARM-1
- **\$find-medication-administrations**  
Find administered medication documents and their related documents. Equivalent to FindMedicationAdministrations query of PHARM-1
- **\$find-prescriptions-for-validation**  
Find prescriptions and their related documents containing Prescription Items ready to be validated. Equivalent to FindPrescriptionsForValidation query of PHARM-1
- 2330 • **\$find-prescriptions-for-dispense**  
Find prescriptions and their related documents containing Prescription Items ready to be dispensed. Equivalent to FindPrescriptionsForDispense query of PHARM-1

- **\$find-medication-list** (if “Provision of Medication List“ Option is supported)

Find the medication list to the patient. Equivalent to FindMedicationList query of PHARM-1

2335 All operations return a list of a list of DocumentReference Resources.

### 3.2.2 Use Case Roles

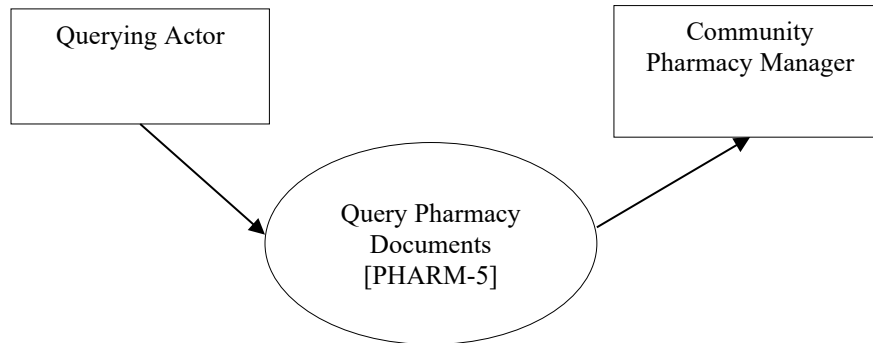

**Actors:** Querying actor

2340 **Role:** Requests an operation by name, and passes parameters to the operation. A parameter controlling the format of the returned data is passed; it selects either object references or full objects.

**Actor:** Community Pharmacy Manager

**Role:** Services the query using its stored definitions of the queries defined for CMPD.

### 3.2.3 Actors and Grouping

2345 If the “Query Pharmacy Document over MHD” Option is supported the following CMPD actors shall be grouped with MHD actors and support respective MHD options.

Actor	Groups with	Note
Medication Treatment Planner <sup>36</sup>	MHD: Document Source MHD: Document Consumer  Option: Comprehensive Metadata	MHD Comprehensive Metadata Option is required in order to fulfill the cardinality requirements of XDS.

---

<sup>36</sup> If “Medication Treatment Planning” Option is used.

## IHE Pharmacy Technical Framework Supplement – Community Medication Prescription and Dispense (CMPD)

Actor	Groups with	Note
Prescription Placer	MHD: Document Source MHD: Document Consumer  Option: Comprehensive Metadata	MHD Comprehensive Metadata Option is required in order to fulfill the cardinality requirements of XDS.
Pharmaceutical Adviser	MHD: Document Source MHD: Document Consumer  Option: Comprehensive Metadata	MHD Comprehensive Metadata Option is required in order to fulfill the cardinality requirements of XDS.
Medication Dispenser	MHD: Document Source MHD: Document Consumer  Option: Comprehensive Metadata	MHD Comprehensive Metadata Option is required in order to fulfill the cardinality requirements of XDS.
Medication Administration Performer	MHD: Document Source MHD: Document Consumer  Option: Comprehensive Metadata	MHD Comprehensive Metadata Option is required in order to fulfill the cardinality requirements of XDS.
Community Pharmacy Manager	MHD: Document Source MHD: Document Consumer  Option: XDS on FHIR	MHD XDS on FHIR Option is required in order to be able to be grouped with an XDS Document Source
Repository Actors:  Medication Treatment Plan <sup>37</sup> Prescription Pharmaceutical Advice Dispensed Medication Administered Medication Medication List <sup>38</sup>	MHD: Document Responder  Options: Comprehensive Metadata XDS on FHIR	MHD Comprehensive Metadata is required in order to fulfill the cardinality requirements of XDS. MHD XDS on FHIR Option is required in order to be able to be grouped with an XDS Document Consumer

### 3.2.4 Referenced Standard

ITI-67: Find Document References and all its related standards.

<sup>37</sup> If “Medication Treatment Planning” Option is used.

<sup>38</sup> If “Persistence of Retrieved Documents” Option is used at Community Pharmacy Manager.

2350 **3.2.5 Messages**

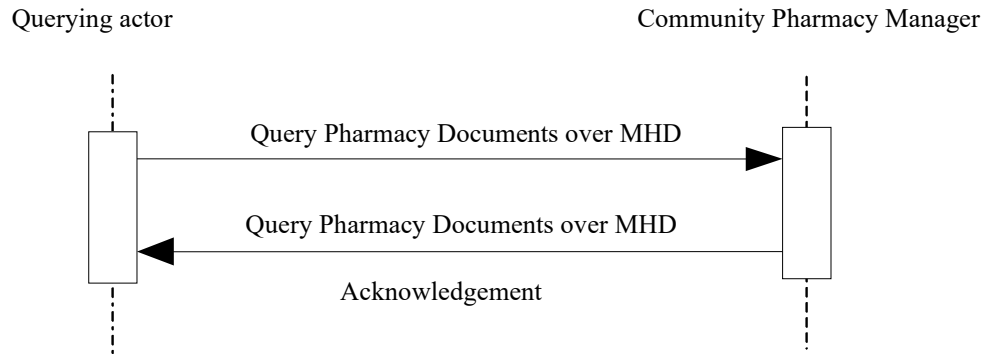

**Figure 3.2.5-1: Interaction Diagram**

**3.2.5.1 Query Pharmacy Documents over MHD**

2355 This is a query request to the Community Pharmacy Manager from a Querying actor. The query request contains:

- A reference to a pre-defined operation stored on the Document Registry.
- Parameters to the operation. The operation parameters are matched up with the corresponding query variables defined in the query definition on the Document Registry.

**3.2.5.1.1 Trigger Events**

2360 This message is initiated when the Querying actor wants to query/retrieve DocumentReference Resources.

This may be the case, if:

- 2365 1. A Medication Treatment Planner, Prescription Placer, Pharmaceutical Adviser, Medication Dispenser or Medication Administration Performer wants to find medication treatment plans, prescriptions, dispenses or administrations (and their related pharmaceutical advices and possibly Community Medication Treatment Plan-, Community Prescription-, Community Dispense- and/or administration documents).
- 2370 2. A Pharmaceutical Adviser wants to find active prescriptions (and their related pharmaceutical advices and possibly Community Medication Treatment Plan-, Community Dispense- and/or administration documents) ready to validate (specialized operation “\$find-prescriptions-for-validation”).
3. A Medication Dispenser wants to find active prescriptions (and their related pharmaceutical advices and possibly Community Medication Treatment Plan-,

- 2375 Community Dispense- and/or administration documents) which are already validated or ready for dispense (specialized operation “\$find-prescriptions-for-dispense”)
4. A Medication Treatment Planner, Prescription Placer, Pharmaceutical Adviser or Medication Dispenser wants to find the Medication List to the patient (operation “\$find-medication-list”)

### 3.2.5.1.2 Message Semantics

- 2380 The Document Consumer executes an HTTP GET against the Document Responder’s DocumentReference URL. The search target follows the FHIR HTTP specification, addressing the DocumentReference Resource <http://hl7.org/fhir/R4/http.html>:

[base]/DocumentReference/<operation>?<query\_parameters>

- 2385 This URL is configurable by the Document Responder and is subject to the following constraints:

The <query\_parameters > represents a series of encoded name-value pairs representing the filter for the operation, as specified in Section 3.67.4.1.2.1 of ITI MHD, as well as control parameters to modify the behavior of the Document Responder such as response format, or pagination.

References to: ITI MHD: 3.67

### 2390 3.2.5.1.2.1 Required Operations

The provided operations are:

- **\$find-medication-treatment-plans (if „Medication Treatment Planning“ Option is supported)**  
Find planned medication documents and their related documents. Equivalent to FindMedicationTreatmentPlans query of PHARM-1
- **\$find-prescriptions**  
Find prescriptions and their related documents. Equivalent to FindPrescriptions query of PHARM-1
- **\$find-dispenses**  
2400 Find dispense documents and their related documents. Equivalent to FindDispenses query of PHARM-1
- **\$find-medication-administrations**  
Find administered medication documents and their related documents. Equivalent to FindMedicationAdministrations query of PHARM-1
- **\$find-prescriptions-for-validation**  
2405

Find prescriptions and their related documents containing Prescription Items ready to be validated. Equivalent to FindPrescriptionsForValidation query of PHARM-1

- **\$find-prescriptions-for-dispense**

2410

Find prescriptions and their related documents containing Prescription Items ready to be dispensed. Equivalent to FindPrescriptionsForDispense query of PHARM-1

- **\$find-medication-list (if “Provision of Medication List“ Option is supported)**

Find the medication list to the patient. Equivalent to FindMedicationList query of PHARM-1

### 3.2.5.1.2.1.1 Parameters for Required Operations

2415

The parameters and business rules for the Required Operations is described in section 3.2.4.1.2.1.1 within corresponding queries sections.

For all operations except \$find-medication-list, the following parameters are supported and are mapped onto corresponding PHARM-1 query parameters:

PHARM-5 Parameter Name	PHARM-1 Equivalent Parameter Name
patient	<i>Not supported</i>
patient.identifier	\$XDSDocumentEntryPatientId
identifier	\$XDSDocumentEntryEntryUUID
identifier	\$XDSDocumentEntryUniqueId
setting	\$XDSDocumentEntryPracticeSettingCode
date <sup>1, 4</sup>	\$XDSDocumentEntryCreationTimeFrom
date <sup>2, 4</sup>	\$XDSDocumentEntryCreationTimeTo
period <sup>1</sup>	\$XDSDocumentEntryServiceStartTimeFrom
period <sup>2</sup>	\$XDSDocumentEntryServiceStartTimeTo
period <sup>1</sup>	\$XDSDocumentEntryServiceStopTimeFrom
period <sup>2</sup>	\$XDSDocumentEntryServiceStopTimeTo
format	\$XDSDocumentEntryFormatCode
facility	\$XDSDocumentEntryHealthcareFacilityTypeCode
event	\$XDSDocumentEntryEventCodeList
security-label	\$XDSDocumentEntryConfidentialityCode
author.given and author.family <sup>5</sup>	\$XDSDocumentEntryAuthorPerson
status	\$XDSDocumentEntryStatus

2420

<sup>1</sup>This parameter is used when the greater than parameter modifier is used on the indexed parameter.

<sup>2</sup>This parameter is used when the less than parameter modifier is used on the indexed parameter.



2425 <sup>4</sup>The FHIR DocumentReference does not yet have a query parameter for creationTime of the document, it has only a date element which is the creation date/time of the DocumentReference. For FHIR R4 we consider equivalent these two elements so that query will function.

<sup>5</sup> The value for this parameter is a pattern compatible with the SQL keyword LIKE which allows the use of the following wildcard characters: % to match any (or no) characters and \_ to match a single character. The match shall be applied to the text contained in the Value elements of the authorPerson Slot on the author Classification (value strings of the authorPerson sub-attribute).

2430 For the \$find-medication-list operation, the following parameters are supported and are mapped onto corresponding PHARM-1 query parameters:

PHARM-5 Parameter Name	PHARM-1 Equivalent Parameter Name <sup>3</sup>
patient	<i>Not supported</i>
patient.identifier	\$XDSDocumentEntryPatientId
period <sup>1</sup>	\$XDSDocumentEntryServiceStartFrom
period <sup>2</sup>	\$XDSDocumentEntryServiceStartTo
period <sup>1</sup>	\$XDSDocumentEntryServiceEndFrom
period <sup>2</sup>	\$XDSDocumentEntryServiceEndTo
format	\$XDSDocumentEntryFormatCode
(not supported) <sup>3</sup>	\$XDSDocumentEntryType
status	\$XDSDocumentEntryStatus

<sup>1</sup>This \$find-document-list parameter is used when the greater than parameter modifier is used on the indexed parameter.

2435 <sup>2</sup>This \$find-document-list parameter is used when the less than parameter modifier is used on the indexed parameter.

<sup>3</sup>The \$XDSDocumentEntryType is not a supported query parameter in HL7 FHIR and thus default value applies.

### 3.2.5.1.2.1.2 Query result examples

2440 Refer to section 3.1.4.1.2.1.2 for Operation result examples.

### 3.2.5.1.3 PHARM-5 Response message

The Community Pharmacy Manager returns a HTTP Status code appropriate to the processing as well as a Bundle of the matching DocumentReference Resources.

#### 3.2.5.1.3.1 Trigger Events

2445 The Document Responder completed processing of the Find Document Reference Request message.

### **3.2.5.1.3.2 Message Semantics**

Based on the query results, the Document Responder will either return an error or success. Guidance on handling Access Denied related to use of 200, 403 and 404 can be found in ITI TF-2x: Appendix Z.7.

2450

When the Document Responder needs to report an error, it shall use HTTP error response codes and should include a FHIR OperationOutcome with more details on the failure. See FHIR <http://hl7.org/fhir/R4/http.html> and <http://hl7.org/fhir/R4/operationoutcome.html>.

2455

If the Query Pharmacy Document over MHD message is processed successfully, whether or not any DocumentReference Resources are found, the HTTP status code shall be 200. The Query Pharmacy Document over MHD Response message shall be a Bundle Resource containing zero or more DocumentReference Resources. If the Document Responder is sending warnings, the Bundle Resource shall also contain an OperationOutcome Resource that contains those warnings.

The response shall adhere to the FHIR Bundle constraints specified in ITI TF-2: Appendix Z.1.

2460

#### **3.2.5.1.3.2.1 DocumentReference Resource Contents**

The DocumentReference Resources returned shall be compliant with the FHIR specification <http://hl7.org/fhir/R4/documentreference.html>

2465

The DocumentReference Resources returned will be compliant with ITI TF-3: 4.5.1.1 for the IHE restrictions on DocumentReference Resource and for a mapping from IHE Document Sharing profiles (e.g., XDS) to FHIR. Document Consumers should be robust to receiving DocumentReference Resources that are not IHE compliant.

#### **3.2.5.1.3.2.2 Resource Bundling**

Resource Bundling shall comply with the guidelines in ITI TF-2: Appendix Z.1.

##### **3.2.5.1.3.2.2.1 Document location**

2470

The Document Responder shall place into the DocumentReference.content.attachment.url element a full URL that can be used by the Document Consumer to retrieve the document using the Retrieve Document [ITI-68] transaction. IHE does not specify the format of the URL. There are many ways to encode this URL that allow for easy processing on a Retrieve Document transaction. Some examples are to encode homeCommunityId, repositoryUniqueId, uniqueId, and patientId into the URL. This could be done in many ways including using character separators or directory separators. In this way, the Document Responder can support many communities, and/or many repositories.

2475

### 3.2.5.1.3.3 Expected Actions

2480 If the Document Responder returns an HTTP redirect response (HTTP status codes 301, 302, 303, or 307), the Document Consumer shall follow the redirect, but may stop processing if it detects a loop. See RFC7231 Section 6.4 Redirection 3xx.

2485 The Document Consumer shall process the results according to application-defined rules. The Document Consumer should be robust as the response may contain DocumentReference Resources that match the query parameters but are not compliant with the DocumentReference constraints defined in ITI TF-3: 4.5.

### 3.2.5.1.4 CapabilityStatement Resource

2490 Document Responders implementing this transaction shall provide a CapabilityStatement Resource as described in ITI TF-2: Appendix Z.3 indicating the query operation for the DocumentReference Resource has been implemented and shall include all query parameters implemented for the DocumentReference Resource.

### 3.2.6 Security Considerations

See MHD Security Considerations in ITI TF-1: 33.5.

2495 This transaction should not return information that the Document Consumer is not authorized to access. Where authorization here is inclusive of system, app, and user according to local policy, patient consents, and security layering. However, the transaction may return DocumentReference resources that have Reference elements that the Document Consumer may not have access to. This is to say that the authorization need only be to the content returned in the Bundle. There may be references (URLs) for which the content is not authorized. This is considered proper as the Document Consumer would need to retrieve the content pointed to by those references, and at that time the proper authorization decision would be made on that context and content. In this way it is possible for a Document Consumer to get DocumentManifest resources that are pointing at data that the Document Consumer is not authorized to retrieve. Thus, the URLs used must be carefully crafted so as to not expose sensitive data in the URL value.

2500 Given that the Document Responder is responsible for the URL placed into DocumentReference.content.attachment.url, care must be taken to assure that manipulation of this URL prior to a Retrieve Document transaction does not expose resources the Document Consumer should not have access to.

Relevant XDS Affinity Domain Security background is discussed in the XDS Security Considerations Section (see ITI TF-1:10.7).

### 2510 3.2.6.1 Security Audit Considerations

The actors involved shall record audit events according to the following:

**3.2.6.1.1 Querying actor audit message:**

	Field Name	Opt	Value Constraints
<b>Event</b> AuditMessage/ EventIdentification	EventID	M	EV(110112, DCM, “Query”)
	EventActionCode	M	“E” (Execute)
	EventDateTime	M	<i>not specialized</i>
	EventOutcomeIndicator	M	<i>not specialized</i>
	EventTypeCode	M	EV(“PHARM-5”, “IHE Transactions”, “Query Pharmacy Documents over MHD”)
<b>Source (Document Consumer) (1)</b>			
<b>Human Requestor (0..n)</b>			
<b>Destination (Document Responder) (1)</b>			
<b>Audit Source (Document Consumer) (1)</b>			
<b>Patient (0..1)</b>			
<b>Query Parameters(1)</b>			

Where:

<b>Source</b> AuditMessage/ ActiveParticipant	UserID	U	<i>not specialized</i>
	AlternativeUserID	M	the process ID as used within the local operating system in the local system logs.
	UserName	U	<i>not specialized</i>
	UserIsRequestor	M	“true”
	RoleIDCode	M	EV(110153, DCM, “Source”)
	NetworkAccessPointTypeCode	M	“1” for machine (DNS) name, “2” for IP address
	NetworkAccessPointID	M	The machine name or IP address, as specified in RFC3881.

2515

<b>Human Requestor (if known)</b> AuditMessage/ ActiveParticipant	UserID	M	Identity of the human that initiated the transaction.
	AlternativeUserID	U	<i>not specialized</i>
	UserName	U	<i>not specialized</i>
	UserIsRequestor	M	“true”
	RoleIDCode	U	Access Control role(s) the user holds that allows this transaction.
	NetworkAccessPointTypeCode	NA	
	NetworkAccessPointID	NA	

<b>Destination</b>	UserID	M	REST endpoint URI.
	AlternativeUserID	U	<i>not specialized</i>

IHE Pharmacy Technical Framework Supplement – Community Medication Prescription and Dispense (CMPD)

AuditMessage/ ActiveParticipant	<i>UserName</i>	<i>U</i>	<i>not specialized</i>
	<i>UserIsRequestor</i>	<i>M</i>	“false”
	<i>RoleIDCode</i>	<i>M</i>	EV(110152, DCM, “Destination”)
	<i>NetworkAccessPointTypeCode</i>	<i>M</i>	“1” for machine (DNS) name, “2” for IP address
	<i>NetworkAccessPointID</i>	<i>M</i>	The machine name or IP address, as specified in RFC3881.

<b>Audit Source</b> AuditMessage/ AuditSourceIdentification	<i>AuditSourceID</i>	<i>U</i>	<i>not specialized</i>
	<i>AuditEnterpriseSiteID</i>	<i>U</i>	<i>not specialized</i>
	<i>AuditSourceTypeCode</i>	<i>U</i>	<i>not specialized</i>

<b>Patient</b> (AuditMessage/ ParticipantObjectIdentification)	<i>ParticipantObjectTypeCode</i>	<i>M</i>	“1” (Person)
	<i>ParticipantObjectTypeCodeRole</i>	<i>M</i>	“1” (Patient)
	<i>ParticipantObjectDataLifeCycle</i>	<i>U</i>	<i>not specialized</i>
	<i>ParticipantObjectIDTypeCode</i>	<i>M</i>	EV(2, RFC-3881, “Patient Number”)
	<i>ParticipantObjectSensitivity</i>	<i>U</i>	<i>not specialized</i>
	<i>ParticipantObjectID</i>	<i>M</i>	The patient ID in HL7 CX format.
	<i>ParticipantObjectName</i>	<i>U</i>	<i>not specialized</i>
	<i>ParticipantObjectQuery</i>	<i>U</i>	<i>not specialized</i>
	<i>ParticipantObjectDetail</i>	<i>U</i>	<i>not specialized</i>

Query Parameters (AuditMessage/ ParticipantObjectIdentification)	<i>ParticipantObjectTypeCode</i>	<i>M</i>	“2” (system object)
	<i>ParticipantObjectTypeCodeRole</i>	<i>M</i>	“24” (query)
	<i>ParticipantObjectDataLifeCycle</i>	<i>U</i>	<i>not specialized</i>
	<i>ParticipantObjectIDTypeCode</i>	<i>M</i>	EV(“PHARM-5”, “IHE Transactions”, “ <b>Query Pharmacy Documents over MHD</b> ”)
	<i>ParticipantObjectSensitivity</i>	<i>U</i>	<i>not specialized</i>
	<i>ParticipantObjectID</i>	<i>M</i>	Stored Operation Name
	<i>ParticipantObjectName</i>	<i>C</i>	If known the value of <ihe:HomeCommunityId/>
	<i>ParticipantObjectQuery</i>	<i>M</i>	the query parameters, base64 encoded

	ParticipantObjectDetail	C	<p>The ParticipantObjectDetail element may occur more than once.</p> <p>In one element, set “QueryEncoding” as the value of the attribute type, Set the attribute value to the character encoding, such as “UTF-8”, used to encode the ParticipantObjectQuery before base64 encoding.</p> <p>In another element, set “urn:ihe:iti:xca:2010:homeCommunityId” as the value of the attribute type and the value of the homeCommunityID as the value of the attribute value, if known.</p>
--	-------------------------	---	--

2520

### 3.2.6.1.2 Community Pharmacy Manager audit message:

	Field Name	Opt	Value Constraints
<b>Event</b> AuditMessage/ EventIdentification	EventID	M	EV(110112, DCM, “Query”)
	EventActionCode	M	“E” (Execute)
	EventDateTime	M	<i>not specialized</i>
	EventOutcomeIndicator	M	<i>not specialized</i>
	EventTypeCode	M	EV(“PHARM-5”, “IHE Transactions”, “Query Pharmacy Documents over MHD”)
<b>Source (Document Consumer) (1)</b>			
<b>Destination (Document Responder) (1)</b>			
<b>Audit Source (Document Responder) (1)</b>			
<b>Patient (0..1)</b>			
<b>Query Parameters(1)</b>			

Where:

<b>Source</b> AuditMessage/ ActiveParticipant	UserID	U	<i>not specialized</i>
	AlternativeUserID	U	<i>not specialized</i>
	UserName	U	<i>not specialized</i>
	UserIsRequestor	M	“true”
	RoleIDCode	M	EV(110153, DCM, “Source”)
	NetworkAccessPointTypeCode	M	“1” for machine (DNS) name, “2” for IP address
	NetworkAccessPointID	M	The machine name or IP address, as specified in RFC3881.

<b>Destination</b> AuditMessage/ ActiveParticipant	UserID	M	REST endpoint URI.
	AlternativeUserID	M	the process ID as used within the local operating system in the local system logs.
	UserName	U	<i>not specialized</i>
	UserIsRequestor	M	“false”
	RoleIDCode	M	EV(110152, DCM, “Destination”)

IHE Pharmacy Technical Framework Supplement – Community Medication Prescription and Dispense (CMPD)

	NetworkAccessPointTypeCode	M	“1” for machine (DNS) name, “2” for IP address
	NetworkAccessPointID	M	The machine name or IP address, as specified in RFC3881.

<b>Audit Source</b> AuditMessage/ AuditSourceIdentification	<i>AuditSourceID</i>	<i>U</i>	<i>not specialized</i>
	<i>AuditEnterpriseSiteID</i>	<i>U</i>	<i>not specialized</i>
	<i>AuditSourceTypeCode</i>	<i>U</i>	<i>not specialized</i>

2525

<b>Patient</b> (AuditMessage/ ParticipantObjectIdentification)	ParticipantObjectTypeCode	M	“1” (Person)
	ParticipantObjectTypeCodeRole	M	“1” (Patient)
	<i>ParticipantObjectDataLifeCycle</i>	<i>U</i>	<i>not specialized</i>
	ParticipantObjectIDTypeCode	M	EV(2, RFC-3881, “Patient Number”)
	<i>ParticipantObjectSensitivity</i>	<i>U</i>	<i>not specialized</i>
	ParticipantObjectID	M	The patient ID in HL7 CX format.
	<i>ParticipantObjectName</i>	<i>U</i>	<i>not specialized</i>
	<i>ParticipantObjectQuery</i>	<i>U</i>	<i>not specialized</i>
	<i>ParticipantObjectDetail</i>	<i>U</i>	<i>not specialized</i>

<b>Query Parameters</b> (AuditMessage/ ParticipantObjectIdentification)	ParticipantObjectTypeCode	M	“2” (system object)
	ParticipantObjectTypeCodeRole	M	“24” (query)
	<i>ParticipantObjectDataLifeCycle</i>	<i>U</i>	<i>not specialized</i>
	ParticipantObjectIDTypeCode	M	EV(“PHARM-5”, “IHE Transactions”, “Query Pharmacy Documents over MHD”)
	<i>ParticipantObjectSensitivity</i>	<i>U</i>	<i>not specialized</i>
	ParticipantObjectID	M	Stored Operation Name
	ParticipantObjectName	C	If known the value of <ihe:HomeCommunityId/>
	ParticipantObjectQuery	M	the query parameters, base64 encoded

	ParticipantObjectDetail	C	<p>The ParticipantObjectDetail element may occur more than once.</p> <p>In one element, set “QueryEncoding” as the value of the attribute type, Set the attribute value to the character encoding, such as “UTF-8”, used to encode the ParticipantObjectQuery before base64 encoding.</p> <p>In another element, set “urn:ihe:iti:xca:2010:homeCommunityId” as the value of the attribute type and the value of the homeCommunityID as the value of the attribute value, if known.</p>
--	-------------------------	---	--

2530 **3.2.6.1.(z) Actor Specific Security Considerations**

No information available yet.



## 4 Workflow Definitions

2535 The management of the workflow related to clinical process has becoming a fundamental topic with the increasing of the use by different sectors of document sharing related IHE profiles with their different types of document and information.

### 4.1 Community Medication Prescription and Dispense Workflow Definition (CMPD-WD)

2540 The management of the workflow related to the CMPD Profile is involved in much clinical and organizational process for its important role in the process of digitalization. The lack of a workflow management blocks the use of the Prescription in an extended way. The definition of a workflow with defined rules and tasks is needed in a scenario cross enterprise in which many actors are involved in the same process.

2545 In this section a set of rules which defines the workflow of the CMPD process and the relationship with the actors involved are described. If real-world scenarios need a technical workflow management the actors involved in the process can use the “Workflow Management” Option which groups the CMPD actors with the XDW actors.

2550 The ITI XDW Profile is a core component of a common, workflow-independent interoperability infrastructure that provides a platform upon which a wide range of specific workflows can be defined by “content specialization” with minimal specification and implementation efforts by the different domains. For the definition of the CMPD workflow it is possible to use the ITI XDW Profile as an infrastructure layer to define a set logical or clinical tasks definitions and rules to apply. The rules in the workflow definition ensure that the different participants in a workflow operate jointly to advance within tasks and to move from one task to another in a consistent way.

2555 To integrate the CMPD Profile with ITI XDW Profile it is necessary to introduce the integrations described in the follow paragraphs.

#### 4.1.1 Actors and Grouping

2560 If the “Workflow Management” Option is supported the following CMPD actors shall be grouped with XDW actors to allow access and manipulation of the XDW-WD (XDW Workflow document).

## IHE Pharmacy Technical Framework Supplement – Community Medication Prescription and Dispense (CMPD)

Actor	Groups with	Note
Medication Treatment Planner <sup>39</sup>	XDW: Content Creator XDW: Content Consumer XDW: Content Updater	The Medication Treatment Planner shall create the XDW-WD to start the process. It also consumes and maybe updates the XDW-WD document in case of modification to the Medication Treatment Plan.
Prescription Placer	XDW: Content Creator XDW: Content Consumer XDW: Content Updater	The Prescription Placer shall create the XDW-WD to start the process if the process was not already started. It also consumes and maybe updates the XDW-WD document in case of modification to the Prescription.
Pharmaceutical Adviser	XDW: Content Consumer XDW: Content Updater	The Pharmaceutical Adviser consumes and updates the XDW-WD after validation of a Prescription Item or modification of a Medication Treatment Plan Item.
Medication Dispenser	XDW: Content Creator XDW: Content Consumer XDW: Content Updater	The Medication Dispenser may create the XDW-WD to start the process if the process was not already started (e.g., in case of dispensing an OTC medication). In case that the process was already started (e.g., in case of a prescribed medication) the Medication Dispenser consumes and updates the XDW-WD after dispensing a Prescription Item.
Medication Administration Performer	XDW: Content Creator XDW: Content Consumer XDW: Content Updater	The Medication Administration Performer may create the XDW-WD to start the process if the process was not already started (e.g., in case of administering a medication without prescription or dispense recorded). In case that the process was already started (e.g., of a prescribed medication) the Medication Administration Performer consumes and updates the XDW-WD after dispensing a Prescription Item.

### 4.1.2 XDW Workflow Document – Common Attributes

2565 The CMPD Workflow Definition does not introduce new metadata and all the metadata elements used are the common XDS document metadata specified in ITI TF-3: 4.1.5 and in ITI TF-3: 5.4.6.

In this section only the use of some specific metadata for the use of XDW in the CMPD context is specified.

<sup>39</sup> If “Medication Treatment Planning” Option is used.

XSDDocumentEntry Attribute	Definition
typeCode	<p>For the Workflow Document which tracks the CMPD process the code for the typeCode shall be:</p> <p><b>Scenario 1: urn:ihe:pharm:cmpdwd1:2011</b>  <b>Scenario 2: urn:ihe:pharm:cmpdwd2:2011</b></p> <p>Note: see Section 4.1.3 for a description of the two workflow scenarios.</p> <p>This code is the same code that shall be used in the element <b>workflowDefinitionReference</b> inside the Workflow Document</p>
eventCodeList	<p>Rule 1:  A CMPD workflow shall be created with code OPEN and shall remain in this status until it is set to CLOSE.</p> <p>Rule 2:  A CMPD workflow should be set to CLOSE by any actor which discovers that the started workflow of</p> <ol style="list-style-type: none"> <li>a) each Medication Treatment Plan Item (for which a task “Plan” has been created) or</li> <li>b) each Prescription Item within (for which a task “Ordering” has been created) or</li> <li>c) each Dispense Item within (for which a task “Dispensing” has been created)</li> <li>d) each Medication Administration Item within (for which a task “Administration” has been created)</li> </ol> <p>has ended (e.g., by either a complete dispense of the item (if no electronic documentation of the medication administration is expected) or by a complete medication administration or any other way, such as cancelation, etc.).</p> <p>See ITI TF-3: 5.4.5.7 for a general description of this attribute.</p>
serviceStartTime	<p>It is the time at which work began on the earliest task for this workflow.</p>
serviceStopTime	<p>It is the time at which the status of the overall Workflow is changed from OPEN to CLOSE.</p> <p>It shall be empty when the workflow is still in OPEN state.</p>

2570

### 4.1.3 Workflow Task Definition

This section describes Workflow Tasks which are used in the XDW Workflow document to express a Community Pharmacy workflow.

2575 The CMPD Process Flow can be principally differentiated in two basic workflow scenarios, one including a validation step by a Pharmaceutical Adviser and another excluding it:

- **Scenario 1: Including a validation step by a Pharmaceutical Adviser**

- **Scenario 2: Not including a validation step by a Pharmaceutical Adviser**

2580 A domain using CMPD has to define in which workflow scenario it operates. If Workflow Scenario 2 is selected, it shall apply on all prescriptions, except those containing provisional Prescription Items for which Workflow Scenario 1 applies. If Scenario 1 is selected, it shall apply the same way to all prescriptions including prescriptions containing provisional Prescription Items.

Please refer to Volume 1, Section 4.4 CMPD Process Flow for a detailed explanation of the Community Pharmacy workflow scenarios.

2585 The following workflow tasks are defined and specified in detail in the following sections:

- Planning
- Ordering
- Validation
- Dispensing
- 2590 • Administering

The CMPD Workflow Definition does not introduce new content specifications for workflow documents and the CMPD workflow documents shall generally follow the XDW content specifications declared in ITI TF-3: 5.4.3.

2595 In this section only the use of some specific content elements for the use of XDW in the CMPD context are specified.

<p><b>Important Note:</b> When referencing input and output documents in tasks, both document <code>uniqueId</code> and <code>homeCommunityId</code> of the document shall be used.</p>
---

#### **4.1.3.1 Task: Planning**

2600 The task “Planning” is able to record the planning of a single Medication Treatment Plan Item (within a Community Medication Treatment Plan document) in a workflow document.

In case the Medication Treatment Planning Option is used, the task starts the Community Pharmacy workflow by creation of the Workflow document.

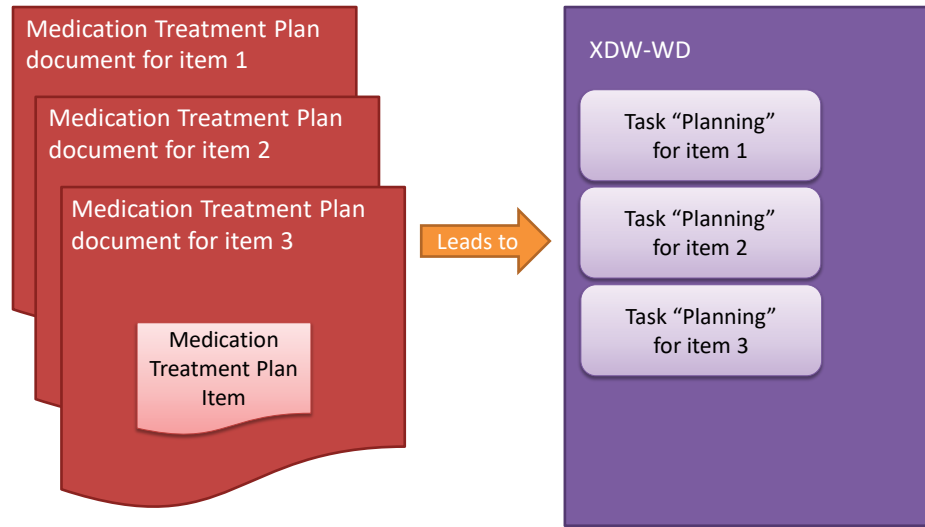

2605

**Figure 4.1.3.1-1: Community Medication Treatment Plan document containing a Medication Treatment Plan Item leading to workflow tasks “Planning”**

**Table 4.1.3.1-1: Planning Task Rules**

Task attributes	Rules for the task “Planning”
Task dependencies	<p><b>Workflow scenario 1</b>                      Ancestors: None                      Successors: Ordering, Dispensing, Administering</p> <p><b>Workflow scenario 2</b>                      Ancestors: None                      Successors: Ordering, Dispensing, Administering</p>
taskDetails.id	Unique id of the instance of the task
taskDetails.taskType	<b>Planning</b>
taskDetails.name	Planning_of_item
taskDetails.actualOwner	Same physician or organization that creates the Community Medication Treatment Plan document
Owner changes allowed	No (task shall not be changed, only one taskEvent)
taskDetails.status	<p><b>COMPLETED</b>                      A Planning task SHALL be always set to COMPLETED.</p>
Status transaction rules	None (task shall not be changed, only one taskEvent)

Task attributes	Rules for the task “Planning”
description	<p>The description element shall contain the MedicationTreatmentPlanItemId, this task is referring to (substanceAdministration/id element of the Medication Treatment Plan Item).</p> <p><u>Format compliant to the HL7 v2 CX datatype:</u></p> <p><i>Variant 1: Only id/@root is given</i>                      \$desc = substanceAdministration/id/@root</p> <p><i>Variant 2: id/@root and id/@extension is given</i>                      \$desc = concat(                                        substanceAdministration/id/@extension, "^^^&amp;",                                        substanceAdministration/id/@root, "&amp;ISO")</p>
input	<ul style="list-style-type: none"> <li>• Optional                             <ul style="list-style-type: none"> <li>○ All documents useful to understand the reason for the planning (clinical reports, ...) MAY be referenced.</li> </ul> </li> </ul>
output	<ul style="list-style-type: none"> <li>• Required                             <ul style="list-style-type: none"> <li>○ The Community Medication Treatment Plan document produced SHALL be referenced.</li> </ul> </li> </ul>
# of taskEvents	Only one creating the “completed” task

2610 Example XML for this XDW task:

```

:
<xdw:taskData>
2615   <ws-ht:taskDetails>
        <ws-ht:id>urn:oid:1.1.1.1.0</ws-ht:id>
        <ws-ht:taskType>Planning</ws-ht:taskType>
        <ws-ht:name>Planning_of_item</ws-ht:name>
2620   <ws-ht:status>COMPLETED</ws-ht:status>
        <ws-ht:actualOwner>Dr. Brum</ws-ht:actualOwner>
        <ws-ht:createdTime>2006-05-04T18:13:51.OZ</ws-ht:createdTime>
        <ws-ht:createdBy>Dr. Brum</ws-ht:createdBy>
        <ws-ht:lastModifiedTime>2006-05-04T18:13:51.OZ</ws-ht:lastModifiedTime>
2625   <ws-ht:renderingMethodExists>>false</ws-ht:renderingMethodExists>
        </ws-ht:taskDetails>

<!--
2630   The description element shall contain the MedicationTreatmentPlanItemId, this
        task is referring to (substanceAdministration/id element of the Medication
        Treatment Plan Item)
    
```

```
-->
<ws-ht:description>4711^^^&1.2.3.4.5.6.7.8.9&ISO</ws-ht:description>

2635 <!-- input documents -->
<ws-ht:input>
  <ws-ht:part name="some clinical document">
    <!-- Document useful to understand the reason of the planning -->
    <ws-ht:attachmentInfo>
      <ws-ht:identifier>1.2.3.4.4</ws-ht:identifier>
2640 <ws-ht:name>Some clinical document</ws-ht:name>
      <ws-ht:accessType>urn:ihe:iti:xdw:2011:XDSregistered</ws-ht:accessType>
      <ws-ht:contentType>application/xml</ws-ht:contentType>
      <ws-ht:contentCategory>http://www.iana.org/assignments/media-types</ws-
2645 ht:contentCategory>
      <ws-ht:attachedTime>2011-04-01T03:15:20.0Z</ws-ht:attachedTime>
      <ws-ht:attachedBy>Dr. Brum</ws-ht:attachedBy>
      <xdw:homeCommunityId>urn:oid:1.2.3</xdw:homeCommunityId>
    </ws-ht:attachmentInfo>
  </ws-ht:part>
2650 </ws-ht:input>

<!-- output documents -->
<ws-ht:output>
  <ws-ht:part name="Medication_Treatment_Plan_Document">
2655 <!-- Community Medication Treatment Plan document -->
    <ws-ht:attachmentInfo>
      <ws-ht:identifier>1.2.3.4.4</ws-ht:identifier>
      <ws-ht:name>MTP document</ws-ht:name>
2660 <ws-ht:accessType>urn:ihe:iti:xdw:2011:XDSregistered</ws-ht:accessType>
      <ws-ht:contentType>application/xml</ws-ht:contentType>
      <ws-ht:contentCategory>http://www.iana.org/assignments/media-types</ws-
ht:contentCategory>
      <ws-ht:attachedTime>2011-04-01T03:15:20.0Z</ws-ht:attachedTime>
      <ws-ht:attachedBy>Dr. Brum</ws-ht:attachedBy>
2665 <xdw:homeCommunityId>urn:oid:1.2.3</xdw:homeCommunityId>
    </ws-ht:attachmentInfo>
  </ws-ht:part>
  </ws-ht:output>
2670 </xdw:taskData>
:
```

#### 4.1.3.2 Task: Ordering

2675 The task “Ordering” is able to record the prescription of a single Prescription Item (within a Community Prescription document) in a workflow document. Since a Community Prescription document may contain more than one Prescription Items, separate tasks have to be created for each Prescription Item of the Prescription.

In case no “Planning” task has been performed before, the “Ordering” task starts the Community Pharmacy workflow by creation of the Workflow document.

2680 In all other cases, the task continues the Community Pharmacy workflow by updating an existing Workflow document.

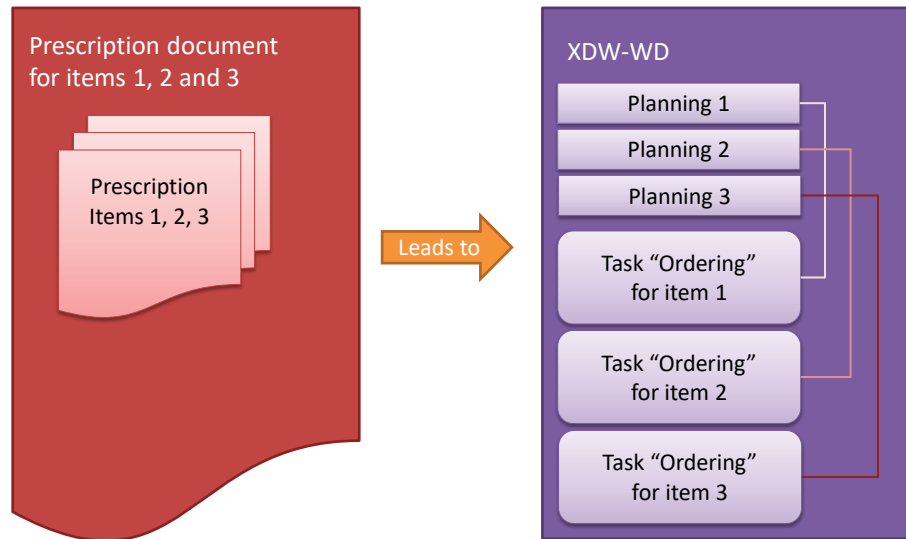

2685 **Figure 4.1.3.2-1: Community Prescription document containing Prescription Items leading to workflow tasks "Ordering"**

**Table 4.1.3.2-1: Ordering Task Rules**

Task attributes	Rules for the task "Ordering"
Task dependencies	<p><b>Workflow scenario 1</b>                      Ancestors: None, Planning, Validation                      Successors: Validation</p> <p><b>Workflow scenario 2</b>                      Ancestors: None, Planning                      Successors: Dispensing, Administering</p>
taskDetails.id	Unique id of the instance of the task
taskDetails.taskType	<b>Ordering</b>
taskDetails.name	Order_of_item
taskDetails.actualOwner	Same physician or organization that creates the Community Prescription document
Owner changes allowed	No (task shall not be changed, only one taskEvent)



Task attributes	Rules for the task “Ordering”
taskDetails.status	<b>COMPLETED</b> An Ordering task SHALL be always set to COMPLETED.
Status transaction rules	None (task shall not be changed, only one taskEvent)
description	The description element shall contain the PrescriptionItemId, this task is referring to (substanceAdministration/id element of the Prescription Item).  <u>Format compliant to the HL7 v2 CX datatype:</u>  <i>Variant 1: Only id/@root is given</i> \$desc = substanceAdministration/id/@root  <i>Variant 2: id/@root and id/@extension is given</i> \$desc = concat( substanceAdministration/id/@extension, "^^&", substanceAdministration/id/@root, "&ISO")
input	<ul style="list-style-type: none"> <li>• Required <ul style="list-style-type: none"> <li>○ The Community Medication Treatment Plan document containing the Medication Treatment Plan Item, the Prescription Item of this task is referring to, SHALL be referenced IF KNOWN.</li> <li>○ The ancestor task SHALL be referenced IF KNOWN.</li> </ul> </li> <li>• Optional <ul style="list-style-type: none"> <li>○ All documents useful to understand the reason for the prescription (clinical reports, ...) MAY be referenced.</li> </ul> </li> </ul>
output	<ul style="list-style-type: none"> <li>• Required <ul style="list-style-type: none"> <li>○ The Community Prescription document produced SHALL be referenced.</li> </ul> </li> </ul>
# of taskEvents	Only one creating the “completed” task

Example XML for this XDW task:

2690

```

:
<xdw:taskData>

  <ws-ht:taskDetails>
    <ws-ht:id>urn:oid:1.1.1.1.1</ws-ht:id>
    <ws-ht:taskType>Ordering</ws-ht:taskType>
    <ws-ht:name>Order_of_item</ws-ht:name>
    <ws-ht:status>COMPLETED</ws-ht:status>
  </ws-ht:taskDetails>

```

2695

# IHE Pharmacy Technical Framework Supplement – Community Medication Prescription and Dispense (CMPD)

```
2700 <ws-ht:actualOwner>Dr. Brum</ws-ht:actualOwner>
<ws-ht:createdTime>2006-05-04T18:13:51.0Z</ws-ht:createdTime>
<ws-ht:createdBy>Dr. Brum</ws-ht:createdBy>
<ws-ht:lastModifiedTime>2006-05-04T18:13:51.0Z</ws-ht:lastModifiedTime>
<ws-ht:renderingMethodExists>>false</ws-ht:renderingMethodExists>
</ws-ht:taskDetails>

2705 <!--
The description element shall contain the PrescriptionItemId, this task is
referring to (substanceAdministration/id element of the Prescription Item)
-->
2710 <ws-ht:description>4711^^^&amp;1.2.3.4.5.6.7.8.9&amp;ISO</ws-ht:description>

<!-- input documents -->
<ws-ht:input>
  <ws-ht:part name="Ancestor_task">
2715 <!-- Ancestor task -->
<ws-ht:attachmentInfo>
  <ws-ht:identifier>1.1.1.1.1</ws-ht:identifier>
  <ws-ht:name>Ancestor task</ws-ht:name>
  <ws-ht:accessType>urn:ihe:iti:xdw:2013:workflowInstanceId</ws-ht:accessType>
  <ws-ht:contentType/>
2720 <ws-ht:contentCategory>http://www.iana.org/assignments/media-types</ws-
ht:contentCategory>
  <ws-ht:attachedTime>2011-04-01T03:15:20.0Z</ws-ht:attachedTime>
  <ws-ht:attachedBy>Dr. Brum</ws-ht:attachedBy>
  </ws-ht:attachmentInfo>
2725 </ws-ht:part>
<ws-ht:part name="Medication_Treatment_Plan_Document">
  <!-- Community Medication Treatment Plan document according to MTP Profile the
Prescription relates to -->
2730 <ws-ht:attachmentInfo>
  <ws-ht:identifier>1.2.3.4.4</ws-ht:identifier>
  <ws-ht:name>MTP document</ws-ht:name>
  <ws-ht:accessType>urn:ihe:iti:xdw:2011:XDSregistered</ws-ht:accessType>
  <ws-ht:contentType>application/xml</ws-ht:contentType>
  <ws-ht:contentCategory>http://www.iana.org/assignments/media-types</ws-
2735 ht:contentCategory>
  <ws-ht:attachedTime>2011-04-01T03:15:20.0Z</ws-ht:attachedTime>
  <ws-ht:attachedBy>Dr. Brum</ws-ht:attachedBy>
  <xdw:homeCommunityId>urn:oid:1.2.3</xdw:homeCommunityId>
  </ws-ht:attachmentInfo>
2740 </ws-ht:part>
<ws-ht:part name="some clinical document">
  <!-- Document useful to understand the reason of the prescription -->
  <ws-ht:attachmentInfo>
2745 <ws-ht:identifier>1.2.3.4.4</ws-ht:identifier>
<ws-ht:name>Some clinical document</ws-ht:name>
<ws-ht:accessType>urn:ihe:iti:xdw:2011:XDSregistered</ws-ht:accessType>
<ws-ht:contentType>application/xml</ws-ht:contentType>
<ws-ht:contentCategory>http://www.iana.org/assignments/media-types</ws-
2750 ht:contentCategory>
  <ws-ht:attachedTime>2011-04-01T03:15:20.0Z</ws-ht:attachedTime>
  <ws-ht:attachedBy>Dr. Brum</ws-ht:attachedBy>
  <xdw:homeCommunityId>urn:oid:1.2.3</xdw:homeCommunityId>
  </ws-ht:attachmentInfo>
```

## IHE Pharmacy Technical Framework Supplement – Community Medication Prescription and Dispense (CMPD)

---

```
2755     </ws-ht:part>
        </ws-ht:input>

        <!-- output documents -->
        <ws-ht:output>
2760     <ws-ht:part name="Prescription_Document">
        <!-- Prescription document according to PRE Profile -->
        <ws-ht:attachmentInfo>
            <ws-ht:identifier>1.2.3.4.4</ws-ht:identifier>
            <ws-ht:name>PRE document</ws-ht:name>
2765     <ws-ht:accessType>urn:ihe:iti:xdw:2011:XDSregistered</ws-ht:accessType>
            <ws-ht:contentType>application/xml</ws-ht:contentType>
            <ws-ht:contentCategory>http://www.iana.org/assignments/media-types</ws-
ht:contentCategory>
            <ws-ht:attachedTime>2011-04-01T03:15:20.0Z</ws-ht:attachedTime>
2770     <ws-ht:attachedBy>Dr. Brum</ws-ht:attachedBy>
            <xdw:homeCommunityId>urn:oid:1.2.3</xdw:homeCommunityId>
        </ws-ht:attachmentInfo>
        </ws-ht:part>
        </ws-ht:output>
2775 </xdw:taskData>
        :
```

2780 **4.1.3.3 Task: Validation**

The task “Validation” is able to record the validation of a single Prescription Item (within a Community Prescription document) in a workflow document. Since a Community Prescription document may contain more than one Prescription Items, separate tasks have to be created for each Prescription Item of the Prescription.

2785 The task continues the Community Pharmacy workflow by updating an existing Workflow document.

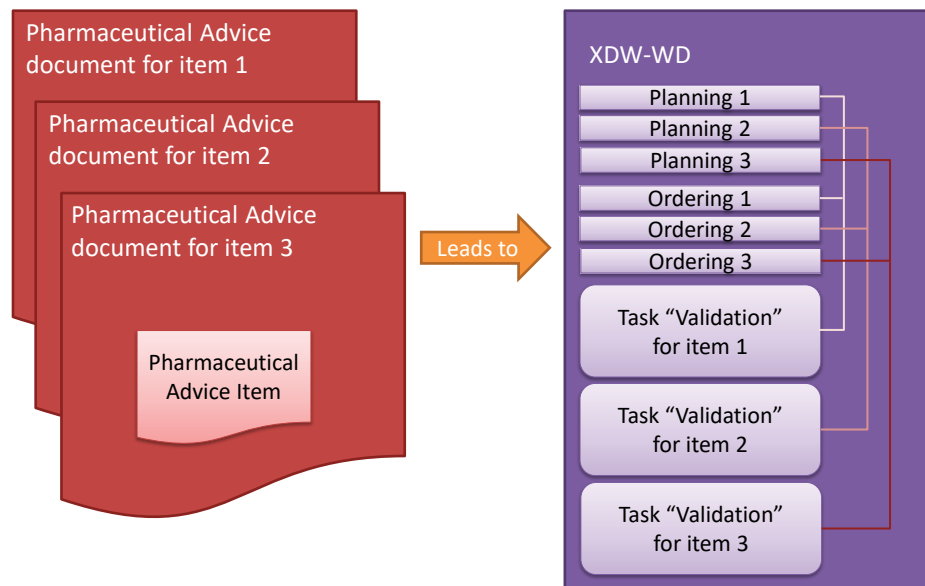

2790 **Figure 4.1.3.3-1: Community Pharmaceutical Advice documents containing Pharmaceutical Advice Items leading to workflow tasks “Validation”**

**Table 4.1.3.3-1: Validation Task Rules**

Task attributes	Rules for the task “Validation”
Task dependencies	<p><b>Workflow scenario 1</b>                      Ancestors: Ordering                      Successors: Dispensing, Administering, Ordering</p> <p><b>Workflow scenario 2</b>                      Not applicable</p>
taskDetails.id	Unique id of the instance of the task
taskDetails.taskType	<b>Validation or Management</b>

Task attributes	Rules for the task “Validation”
taskDetails.name	ValidationManagement_of_item
taskDetails.actualOwner	Same physician or organization that creates the Community Pharmaceutical Advice document
Owner changes allowed	No (task shall not be changed, only one taskEvent)
taskDetails.status	<b>COMPLETED</b> A Validation or Management task SHALL be always set to COMPLETED.
Status transaction rules	None (task shall not be changed, only one taskEvent)
description	The description element shall contain the PharmaceuticalAdviceItemId, this task is referring to (observation/id element of the Pharmaceutical Advice Item).  <u>Format compliant to the HL7 v2 CX datatype:</u>  <i>Variant 1: Only id/@root is given</i> \$desc = observation/id/@root  <i>Variant 2: id/@root and id/@extension is given</i> \$desc = concat( observation/id/@extension, "^^^&", observation/id/@root, "&ISO")
input	<ul style="list-style-type: none"> <li>• Required <ul style="list-style-type: none"> <li>○ The document containing the item (Prescription-, Dispense- or Medication Administration Item), the Pharmaceutical Advice Item of this task is referring to, SHALL be referenced.</li> <li>○ The ancestor task SHALL be referenced IF KNOWN.</li> </ul> </li> <li>• Optional <ul style="list-style-type: none"> <li>○ All additional documents useful to understand the reason for the outcome of the Pharmaceutical Advice MAY be referenced.</li> </ul> </li> </ul>
output	<ul style="list-style-type: none"> <li>• Required <ul style="list-style-type: none"> <li>○ The Community Pharmaceutical Advice document produced SHALL be referenced.</li> </ul> </li> </ul>
# of taskEvents	Only one creating the “completed” task

2795

Example XML for this XDW task:

2800

```

:
<xdw:taskData>
  <ws-ht:taskDetails>
    <ws-ht:id>urn:oid:2.2.2.2.2</ws-ht:id>
    <ws-ht:taskType>Validation or Management</ws-ht:taskType>
    <ws-ht:name>ValidationManagement_of_item</ws-ht:name>
    <ws-ht:status>COMPLETED</ws-ht:status>
    <ws-ht:actualOwner>Dr. Brum</ws-ht:actualOwner>
    <ws-ht:createdTime>2006-05-04T18:13:51.OZ</ws-ht:createdTime>
    <ws-ht:createdBy>Dr. Brum</ws-ht:createdBy>
    <ws-ht:lastModifiedTime>2006-05-04T18:13:51.OZ</ws-ht:lastModifiedTime>
    <ws-ht:renderingMethodExists>>false</ws-ht:renderingMethodExists>
  </ws-ht:taskDetails>

  <!--
  The description element shall contain the PharmaceuticalAdviceItemId, this task is
  referring to (observation/id element of the Pharmaceutical Advice Item)
  -->
  <ws-ht:description>4711^^^&amp;1.2.3.4.5.6.7.8.9&amp;ISO</ws-ht:description>

  <!-- input documents -->
  <ws-ht:input>
    <ws-ht:part name="Ancestor_task">
      <!-- Ancestor task -->
      <ws-ht:attachmentInfo>
        <ws-ht:identifier>1.1.1.1.1</ws-ht:identifier>
        <ws-ht:name>Ancestor task</ws-ht:name>
        <ws-ht:accessType>urn:ihe:iti:xdw:2013:workflowInstanceId</ws-ht:accessType>
        <ws-ht:contentType/>
        <ws-ht:contentCategory>http://www.iana.org/assignments/media-types</ws-
      ht:contentCategory>
        <ws-ht:attachedTime>2011-04-01T03:15:20.OZ</ws-ht:attachedTime>
        <ws-ht:attachedBy>Dr. Brum</ws-ht:attachedBy>
      </ws-ht:attachmentInfo>
    </ws-ht:part>
    <ws-ht:part name="Prescription Document">
      <!-- Prescription document according to PRE Profile the Pharmaceutical Advice
      relates to -->
      <ws-ht:attachmentInfo>
        <ws-ht:identifier>1.2.3.4.4</ws-ht:identifier>
        <ws-ht:name>PRE document</ws-ht:name>
        <ws-ht:accessType>urn:ihe:iti:xdw:2011:XDSregistered</ws-ht:accessType>
        <ws-ht:contentType>application/xml</ws-ht:contentType>
        <ws-ht:contentCategory>http://www.iana.org/assignments/media-types</ws-
      ht:contentCategory>
        <ws-ht:attachedTime>2011-04-01T03:15:20.OZ</ws-ht:attachedTime>
        <ws-ht:attachedBy>Dr. Brum</ws-ht:attachedBy>
        <xdw:homeCommunityId>urn:oid:1.2.3</xdw:homeCommunityId>
      </ws-ht:attachmentInfo>
    </ws-ht:part>
  </ws-ht:input>

```

2805

2810

2815

2820

2825

2830

2835

2840

2845

## IHE Pharmacy Technical Framework Supplement – Community Medication Prescription and Dispense (CMPD)

---

```
2850 </ws-ht:input>
      <!-- output documents -->
      <ws-ht:output>
        <ws-ht:part name="Pharmaceutical_Advice_Document">
          <!-- Pharmaceutical Advice document according to PADV Profile -->
2855 <ws-ht:attachmentInfo>
          <ws-ht:identifier>1.2.3.4.4</ws-ht:identifier>
          <ws-ht:name>PADV document</ws-ht:name>
          <ws-ht:accessType>urn:ihe:iti:xdw:2011:XDSregistered</ws-ht:accessType>
2860 <ws-ht:contentType>application/xml</ws-ht:contentType>
          <ws-ht:contentCategory>http://www.iana.org/assignments/media-types</ws-
ht:contentCategory>
          <ws-ht:attachedTime>2011-04-01T03:15:20.0Z</ws-ht:attachedTime>
          <ws-ht:attachedBy>Dr. Brum</ws-ht:attachedBy>
          <xdw:homeCommunityId>urn:oid:1.2.3</xdw:homeCommunityId>
2865 </ws-ht:attachmentInfo>
        </ws-ht:part>
      </ws-ht:output>
    </xdw:taskData>
2870 :
```

2875 **4.1.3.4 Task: Dispensing**

The task “Dispensing” is able to record the dispense of a single Dispense Item (within a Community Dispense document) in a workflow document.

2880 In case no “Planning” or “Ordering” task has been performed before, the “Dispensing” task starts the Community Pharmacy workflow by creation of the Workflow document (e.g., OTC medication).

In all other cases, the task continues the Community Pharmacy workflow by updating an existing Workflow document.

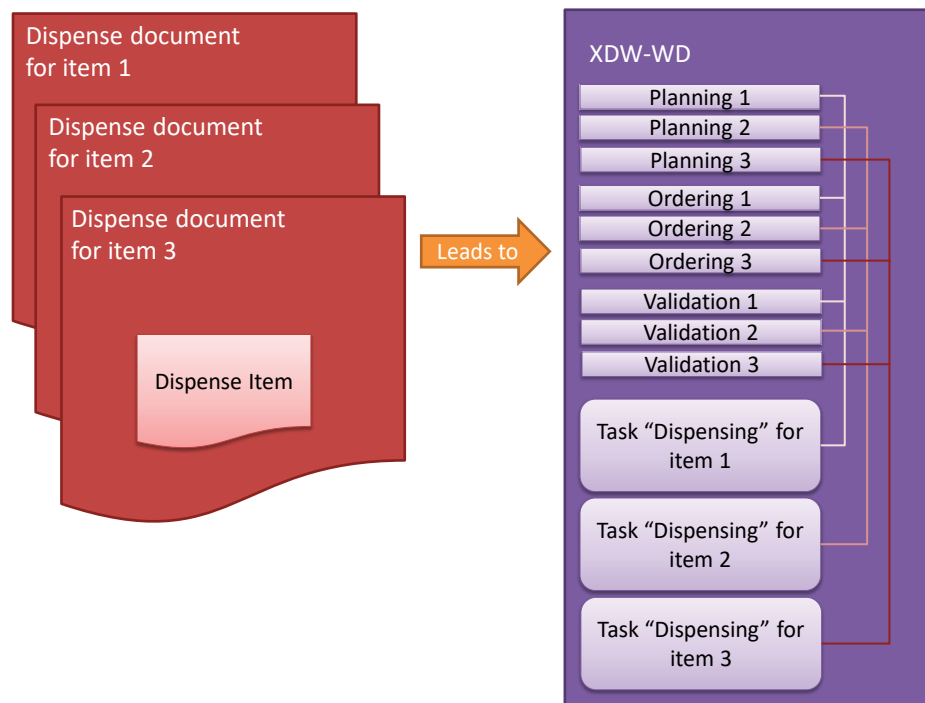

2885 **Figure 4.1.3.4-1: Community Dispense documents containing Dispense Items leading to workflow tasks “Dispensing”**

**Table 4.1.3.4-1: Dispensing Task Rules**

Task attributes	Rules for the task “Dispensing”
Task dependencies	<p><b>Workflow scenario 1</b>                      Ancestors: None, Validation                      Successors: Dispensing, Administration</p> <p><b>Workflow scenario 2</b></p>



IHE Pharmacy Technical Framework Supplement – Community Medication Prescription and Dispense (CMPD)

Task attributes	Rules for the task “Dispensing”		
	Ancestors: None, Planning, Ordering Successors: Dispensing, Administration		
taskDetails.id	Unique id of the instance of the task		
taskDetails.taskType	<b>Dispensing</b>		
taskDetails.name	Dispense_of_item		
taskDetails.actualOwner	Same physician or organization that creates the Community Dispense document.		
<table border="1" style="width: 100%; border-collapse: collapse;"> <tr> <td style="width: 15%;"></td> <td>Owner changes allowed</td> </tr> </table>		Owner changes allowed	No (task shall not be changed, only one taskEvent)
	Owner changes allowed		
taskDetails.status	<b>COMPLETED</b> A Dispensing task SHALL be always set to COMPLETED.		
<table border="1" style="width: 100%; border-collapse: collapse;"> <tr> <td style="width: 15%;"></td> <td>Status transaction rules</td> </tr> </table>		Status transaction rules	None (task shall not be changed, only one taskEvent)
	Status transaction rules		
description	The description element shall contain the DispenseItemid, this task is referring to (supply/id element of the Dispense Item).  <u>Format compliant to the HL7 v2 CX datatype:</u>  <i>Variant 1: Only id/@root is given</i> Sdesc = supply/id/@root  <i>Variant 2: id/@root and id/@extension is given</i> Sdesc = concat( supply/id/@extension, "^^&", supply/id/@root, "&ISO")		
input	<ul style="list-style-type: none"> <li>• Required                         <ul style="list-style-type: none"> <li>○ The Community Medication Treatment Plan document containing the Medication Treatment Plan Item, the Dispense Item of this task is referring to, SHALL be referenced IF KNOWN.</li> <li>○ The Community Prescription document containing the Prescription Item, the Dispense Item of this task is referring to, SHALL be referenced IF KNOWN.</li> <li>○ The Community Pharmaceutical Advice document containing the Pharmaceutical Advice Item, the Dispense Item of this task is referring to, SHALL be referenced IF KNOWN.                                 <ul style="list-style-type: none"> <li>▪ E.g., the Pharmaceutical Advice on the underlying Prescription Item which approved the dispensing act (in case of scenario 1, “with validation step”)</li> </ul> </li> <li>○ The ancestor task SHALL be referenced IF KNOWN.</li> </ul> </li> </ul>		

IHE Pharmacy Technical Framework Supplement – Community Medication Prescription and Dispense (CMPD)

Task attributes	Rules for the task “Dispensing”
output	<ul style="list-style-type: none"> <li>• Required                             <ul style="list-style-type: none"> <li>○ The Community Dispense document produced SHALL be referenced.</li> </ul> </li> </ul>
# of taskEvents	Only one creating the “completed” task

Example XML for this XDW task:

2890

2895

2900

2905

2910

2915

2920

2925

2930

```

:
<xdw:taskData>

  <ws-ht:taskDetails>
    <ws-ht:id>urn:oid:3.3.3.3</ws-ht:id>
    <ws-ht:taskType>Dispensing</ws-ht:taskType>
    <ws-ht:name>Dispense_of_item</ws-ht:name>
    <ws-ht:status>COMPLETED</ws-ht:status>
    <ws-ht:actualOwner>Dr. Brum</ws-ht:actualOwner>
    <ws-ht:createdTime>2006-05-04T18:13:51.OZ</ws-ht:createdTime>
    <ws-ht:createdBy>Dr. Brum</ws-ht:createdBy>
    <ws-ht:lastModifiedTime>2006-05-04T18:13:51.OZ</ws-ht:lastModifiedTime>
    <ws-ht:renderingMethodExists>>false</ws-ht:renderingMethodExists>
  </ws-ht:taskDetails>

  <!--
  The description element shall contain the DispenseItemId, this task is
  referring to (supply/id element of the Dispense Item)
  -->
  <ws-ht:description>4711^^^&amp;1.2.3.4.5.6.7.8.9&amp;ISO</ws-ht:description>

  <!-- input documents -->
  <ws-ht:input>
    <ws-ht:part name="Ancestor_task">
      <!-- Ancestor task -->
      <ws-ht:attachmentInfo>
        <ws-ht:identifier>1.1.1.1.1</ws-ht:identifier>
        <ws-ht:name>Ancestor task</ws-ht:name>
        <ws-ht:accessType>urn:ihe:iti:xdw:2013:workflowInstanceId</ws-ht:accessType>
        <ws-ht:contentType/>
        <ws-ht:contentCategory>http://www.iana.org/assignments/media-types</ws-
ht:contentCategory>
        <ws-ht:attachedTime>2011-04-01T03:15:20.OZ</ws-ht:attachedTime>
        <ws-ht:attachedBy>Dr. Brum</ws-ht:attachedBy>
      </ws-ht:attachmentInfo>
    </ws-ht:part>
    <ws-ht:part name="Medication_Treatment_Plan_Document">
      <!-- Community Medication Treatment Plan document according to MTP Profile the
      Dispense relates to -->
      <ws-ht:attachmentInfo>
        <ws-ht:identifier>1.2.3.4.4</ws-ht:identifier>
        <ws-ht:name>MTP document</ws-ht:name>
  
```

# IHE Pharmacy Technical Framework Supplement – Community Medication Prescription and Dispense (CMPD)

```
2935     <ws-ht:accessType>urn:ihe:iti:xdw:2011:XDSregistered</ws-ht:accessType>
     <ws-ht:contentType>application/xml</ws-ht:contentType>
     <ws-ht:contentCategory>http://www.iana.org/assignments/media-types</ws-
2940 ht:contentCategory>
     <ws-ht:attachedTime>2011-04-01T03:15:20.0Z</ws-ht:attachedTime>
     <ws-ht:attachedBy>Dr. Brum</ws-ht:attachedBy>
     <xdw:homeCommunityId>urn:oid:1.2.3</xdw:homeCommunityId>
     </ws-ht:attachmentInfo>
     </ws-ht:part>
     <ws-ht:part name="Prescription Document">
       <!-- Prescription document according to PRE Profile the
2945         Dispense relates to -->
       <ws-ht:attachmentInfo>
         <ws-ht:identifier>1.2.3.4.4</ws-ht:identifier>
         <ws-ht:name>PRE document</ws-ht:name>
         <ws-ht:accessType>urn:ihe:iti:xdw:2011:XDSregistered</ws-ht:accessType>
2950         <ws-ht:contentType>application/xml</ws-ht:contentType>
         <ws-ht:contentCategory>http://www.iana.org/assignments/media-types</ws-
         ht:contentCategory>
         <ws-ht:attachedTime>2011-04-01T03:15:20.0Z</ws-ht:attachedTime>
         <ws-ht:attachedBy>Dr. Brum</ws-ht:attachedBy>
         <xdw:homeCommunityId>urn:oid:1.2.3</xdw:homeCommunityId>
2955         </ws-ht:attachmentInfo>
         </ws-ht:part>
         <ws-ht:part name="Pharmaceutical Advice Document">
           <!-- Pharmaceutical Advice document according to PADV Profile the
2960             Dispense relates to -->
           <ws-ht:attachmentInfo>
             <ws-ht:identifier>1.2.3.4.4</ws-ht:identifier>
             <ws-ht:name>PADV document</ws-ht:name>
             <ws-ht:accessType>urn:ihe:iti:xdw:2011:XDSregistered</ws-ht:accessType>
2965             <ws-ht:contentType>application/xml</ws-ht:contentType>
             <ws-ht:contentCategory>http://www.iana.org/assignments/media-types</ws-
             ht:contentCategory>
             <ws-ht:attachedTime>2011-04-01T03:15:20.0Z</ws-ht:attachedTime>
             <ws-ht:attachedBy>Dr. Brum</ws-ht:attachedBy>
             <xdw:homeCommunityId>urn:oid:1.2.3</xdw:homeCommunityId>
2970             </ws-ht:attachmentInfo>
             </ws-ht:part>
             </ws-ht:input>

           <!-- output documents -->
2975           <ws-ht:output>
             <ws-ht:part name="Dispense Document">
               <!-- Dispense document according to DIS Profile -->
               <ws-ht:attachmentInfo>
                 <ws-ht:identifier>1.2.3.4.4</ws-ht:identifier>
2980                 <ws-ht:name>DIS document</ws-ht:name>
                 <ws-ht:accessType>urn:ihe:iti:xdw:2011:XDSregistered</ws-ht:accessType>
                 <ws-ht:contentType>application/xml</ws-ht:contentType>
                 <ws-ht:contentCategory>http://www.iana.org/assignments/media-types</ws-
2985                 ht:contentCategory>
                 <ws-ht:attachedTime>2011-04-01T03:15:20.0Z</ws-ht:attachedTime>
                 <ws-ht:attachedBy>Dr. Brum</ws-ht:attachedBy>
                 <xdw:homeCommunityId>urn:oid:1.2.3</xdw:homeCommunityId>
                 </ws-ht:attachmentInfo>
```

2990

```
</ws-ht:part>  
</ws-ht:output>  
  
</xdw:taskData>  
:
```

2995

### 4.1.3.5 Task: Administering

The task “Administering” is able to record the administration of a single Medication Administration Item (within a Community Medication Administration document) in a workflow document.

3000

In case no “Planning”, “Ordering” or “Dispensing” task has been performed before, the “Administering” task starts the Community Pharmacy workflow by creation of the Workflow document (e.g., ad-hoc administration of medication).

In all other cases, the task continues the Community Pharmacy workflow by updating an existing Workflow document.

3005

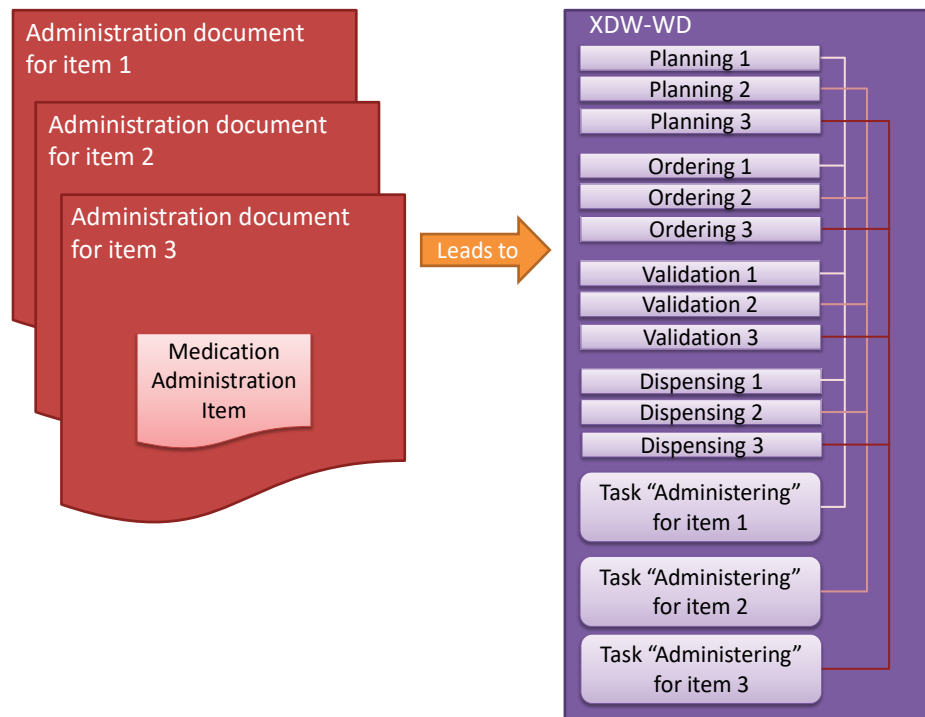

**Figure 4.1.3.4-1: Community Medication Administration documents containing Medication Administration Items leading to workflow tasks “Administering”**



Task attributes	Rules for the task “Administering”
	<ul style="list-style-type: none"> <li>○ The Community Dispense document containing the Dispense Item, the Medication Administration Item of this task is referring to, SHALL be referenced IF KNOWN.</li> <li>○ The Community Pharmaceutical Advice document containing the Pharmaceutical Advice Item, the Medication Administration Item of this task is referring to, SHALL be referenced IF KNOWN.                             <ul style="list-style-type: none"> <li>▪ E.g., a Pharmaceutical Advice to the underlying dispense of this administration, indicating that the dosage instructions have changed since the last administration of the dispensed medication</li> </ul> </li> <li>○ The ancestor task SHALL be referenced IF KNOWN.</li> </ul>
output	<ul style="list-style-type: none"> <li>• Required                             <ul style="list-style-type: none"> <li>○ The Community Medication Administration document produced SHALL be referenced.</li> </ul> </li> </ul>
# of taskEvents	Only one creating the “completed” task

3010 Example XML for this XDW task:

```

:
<xdw:taskData>
3015   <ws-ht:taskDetails>
        <ws-ht:id>urn:oid:3.3.3.3.3</ws-ht:id>
        <ws-ht:taskType>Dispensing</ws-ht:taskType>
        <ws-ht:name>Administration_of_item</ws-ht:name>
3020   <ws-ht:status>COMPLETED</ws-ht:status>
        <ws-ht:actualOwner>Dr. Brum</ws-ht:actualOwner>
        <ws-ht:createdTime>2006-05-04T18:13:51.OZ</ws-ht:createdTime>
        <ws-ht:createdBy>Dr. Brum</ws-ht:createdBy>
        <ws-ht:lastModifiedTime>2006-05-04T18:13:51.OZ</ws-ht:lastModifiedTime>
3025   <ws-ht:renderingMethodExists>>false</ws-ht:renderingMethodExists>
    </ws-ht:taskDetails>

    <!--
3030   The description element shall contain the PrescriptionItemId, this task is
        referring to (substanceAdministration/id element of the Prescription Item)
    -->
    <ws-ht:description>4711^^^&amp;1.2.3.4.5.6.7.8.9&amp;ISO</ws-ht:description>

    <!-- input documents -->
3035   <ws-ht:input>
        <ws-ht:part name="Ancestor_task">
            <!-- Ancestor task -->
            <ws-ht:attachmentInfo>
                <ws-ht:identifier>1.1.1.1.1</ws-ht:identifier>
                <ws-ht:name>Ancestor task</ws-ht:name>
        </ws-ht:part>
    </ws-ht:input>

```

# IHE Pharmacy Technical Framework Supplement – Community Medication Prescription and Dispense (CMPD)

```
3040     <ws-ht:accessType>urn:ihe:iti:xdw:2013:workflowInstanceId</ws-ht:accessType>
     <ws-ht:contentType/>
     <ws-ht:contentCategory>http://www.iana.org/assignments/media-types</ws-
3045 ht:contentCategory>
     <ws-ht:attachedTime>2011-04-01T03:15:20.0Z</ws-ht:attachedTime>
     <ws-ht:attachedBy>Dr. Brum</ws-ht:attachedBy>
     </ws-ht:attachmentInfo>
     </ws-ht:part>
     <ws-ht:part name="Medication_Treatment_Plan_Document">
3050     <!-- Community Medication Treatment Plan document according to MTP Profile the
           Medication Administration relates to -->
     <ws-ht:attachmentInfo>
     <ws-ht:identifier>1.2.3.4.4</ws-ht:identifier>
     <ws-ht:name>MTP document</ws-ht:name>
3055     <ws-ht:accessType>urn:ihe:iti:xdw:2011:XDSregistered</ws-ht:accessType>
     <ws-ht:contentType>application/xml</ws-ht:contentType>
     <ws-ht:contentCategory>http://www.iana.org/assignments/media-types</ws-
ht:contentCategory>
     <ws-ht:attachedTime>2011-04-01T03:15:20.0Z</ws-ht:attachedTime>
     <ws-ht:attachedBy>Dr. Brum</ws-ht:attachedBy>
3060     <xdw:homeCommunityId>urn:oid:1.2.3</xdw:homeCommunityId>
     </ws-ht:attachmentInfo>
     </ws-ht:part>
     <ws-ht:part name="Prescription_Document">
3065     <!-- Prescription document according to PRE Profile the
           Medication Administration relates to -->
     <ws-ht:attachmentInfo>
     <ws-ht:identifier>1.2.3.4.4</ws-ht:identifier>
     <ws-ht:name>PRE document</ws-ht:name>
3070     <ws-ht:accessType>urn:ihe:iti:xdw:2011:XDSregistered</ws-ht:accessType>
     <ws-ht:contentType>application/xml</ws-ht:contentType>
     <ws-ht:contentCategory>http://www.iana.org/assignments/media-types</ws-
ht:contentCategory>
     <ws-ht:attachedTime>2011-04-01T03:15:20.0Z</ws-ht:attachedTime>
     <ws-ht:attachedBy>Dr. Brum</ws-ht:attachedBy>
3075     <xdw:homeCommunityId>urn:oid:1.2.3</xdw:homeCommunityId>
     </ws-ht:attachmentInfo>
     </ws-ht:part>
     <ws-ht:part name="Dispense_Document">
3080     <!-- Dispense document according to DIS Profile the
           Medication Administration relates to -->
     <ws-ht:attachmentInfo>
     <ws-ht:identifier>1.2.3.4.4</ws-ht:identifier>
     <ws-ht:name>DIS document</ws-ht:name>
3085     <ws-ht:accessType>urn:ihe:iti:xdw:2011:XDSregistered</ws-ht:accessType>
     <ws-ht:contentType>application/xml</ws-ht:contentType>
     <ws-ht:contentCategory>http://www.iana.org/assignments/media-types</ws-
ht:contentCategory>
     <ws-ht:attachedTime>2011-04-01T03:15:20.0Z</ws-ht:attachedTime>
     <ws-ht:attachedBy>Dr. Brum</ws-ht:attachedBy>
3090     <xdw:homeCommunityId>urn:oid:1.2.3</xdw:homeCommunityId>
     </ws-ht:attachmentInfo>
     </ws-ht:part>
     <ws-ht:part name="Pharmaceutical_Advice_Document">
3095     <!-- Pharmaceutical Advice document according to PADV Profile the
           Medication Administration relates to -->
```

# IHE Pharmacy Technical Framework Supplement – Community Medication Prescription and Dispense (CMPD)

```
3100     <ws-ht:attachmentInfo>
        <ws-ht:identifier>1.2.3.4.4</ws-ht:identifier>
        <ws-ht:name>PADV document</ws-ht:name>
        <ws-ht:accessType>urn:ihe:iti:xdw:2011:XDSregistered</ws-ht:accessType>
        <ws-ht:contentType>application/xml</ws-ht:contentType>
        <ws-ht:contentCategory>http://www.iana.org/assignments/media-types</ws-
3105 ht:contentCategory>
        <ws-ht:attachedTime>2011-04-01T03:15:20.0Z</ws-ht:attachedTime>
        <ws-ht:attachedBy>Dr. Brum</ws-ht:attachedBy>
        <xdw:homeCommunityId>urn:oid:1.2.3</xdw:homeCommunityId>
        </ws-ht:attachmentInfo>
        </ws-ht:part>
    </ws-ht:input>

3110 <!-- output documents -->
    <ws-ht:output>
        <ws-ht:part name="Medication_Administration_Document">
3115     <!-- Medication Administration document according to CMA Profile -->
        <ws-ht:attachmentInfo>
            <ws-ht:identifier>1.2.3.4.4</ws-ht:identifier>
            <ws-ht:name>CMA document</ws-ht:name>
            <ws-ht:accessType>urn:ihe:iti:xdw:2011:XDSregistered</ws-ht:accessType>
            <ws-ht:contentType>application/xml</ws-ht:contentType>
            <ws-ht:contentCategory>http://www.iana.org/assignments/media-types</ws-
3120 ht:contentCategory>
            <ws-ht:attachedTime>2011-04-01T03:15:20.0Z</ws-ht:attachedTime>
            <ws-ht:attachedBy>Dr. Brum</ws-ht:attachedBy>
            <xdw:homeCommunityId>urn:oid:1.2.3</xdw:homeCommunityId>
            </ws-ht:attachmentInfo>
3125     </ws-ht:part>
        </ws-ht:output>
    </xdw:taskData>
    :
```

3130