

Integrating the Healthcare Enterprise



5 **IHE Pathology and Laboratory Medicine (PaLM)
Technical Framework**

10 **Volume 2c
(PaLM TF-2c)
Transactions (cont.)**

15

20

**Revision 9.0 - Final Text
August 7, 2018**

25

Please verify you have the most recent version of this document, which is published [here](#).

CONTENTS

1	Introduction.....	6
30	1.1 Introduction to IHE.....	6
	1.2 Intended Audience.....	6
	1.3 Overview of Technical Framework Volume 2.....	6
	1.4 Comment Process.....	7
	1.5 Copyright Licenses.....	7
35	1.5.1 Copyright of Base Standards.....	7
	1.6 Trademark.....	8
	1.7 Disclaimer Regarding Patent Rights.....	8
	1.8 History of Document Changes.....	8
2	Conventions.....	9
40	2.1 Transaction Modeling and Profiling Conventions.....	9
	2.2 Additional Standards Profiling Conventions.....	9
	2.3 Use of Coded Entities and Coding Schemes.....	9
3	IHE Transactions.....	10
	3.30 Initiate POCT on a patient specimen [LAB-30].....	11
45	3.30.1 Scope.....	11
	3.30.2 Actor Roles.....	11
	3.30.3 Referenced Standards.....	12
	3.30.4 Interaction Diagram.....	12
	3.30.4.1 Message OBS.R01 and its acknowledgement ACK.R01.....	12
50	3.30.4.1.1 Trigger Events.....	13
	3.30.4.1.2 Message Semantics.....	13
	3.30.4.1.2.1 Message OBS.R01, status_cd = 'INI'.....	13
	3.30.4.1.2.2 Use of the Service Object.....	15
	3.30.4.1.2.3 Use of the Patient Object.....	15
55	3.30.4.1.2.4 Use of the Operator Object.....	15
	3.30.4.1.2.5 Use of the Order Object.....	16
	3.30.4.1.2.6 Use of the Specimen object.....	16
	3.30.4.1.2.7 Example Message OBS.R01: Initiate POCT on a Patient Specimen.....	17
	3.30.4.1.2.8 Acknowledgement with Patient Name – Message ACK.R01.....	17
60	3.30.4.1.2.9 Use of the Header Object.....	18
	3.30.4.1.2.10 Use of the Acknowledgement Object.....	18
	3.30.4.1.3 Expected Actions.....	19
	3.30.5 Security Considerations.....	19
	3.31 Produced Observation Set [LAB-31].....	20
65	3.31.1 Scope.....	20
	3.31.2 Actor Roles.....	20
	3.31.3 Referenced Standards.....	20
	3.31.4 Interaction Diagram.....	21

	3.31.4.1	Messages OBS.R01 and OBS.R02	21
70	3.31.4.1.1	Trigger Events.....	21
	3.31.4.1.2	Message Semantics	22
	3.31.4.1.2.1	Message OBS.R01: Patient-Related Set of Observations.....	22
	3.31.4.1.2.2	Use of the Service Object	24
	3.31.4.1.2.3	Use of the Patient Object	24
75	3.31.4.1.2.4	Use of the Observation Object.....	25
	3.31.4.1.2.5	Use of the Note Object Related to the Observation Object	26
	3.31.4.1.2.6	Use of the Operator Object	26
	3.31.4.1.2.7	Use of the Order Object.....	26
	3.31.4.1.2.8	Use of the Specimen Object	26
80	3.31.4.1.2.9	Use of the Reagent Object	27
	3.31.4.1.2.10	Use of the Note Object	27
	3.31.4.1.2.11	Example of Patient-Related Observations Message.....	27
	3.31.4.1.2.12	Message OBS.R02: QC-Related Set of Observations	29
	3.31.4.1.2.13	Use of the Service Object.....	29
85	3.31.4.1.2.14	Use of the Control/Calibration Object.....	30
	3.31.4.1.2.15	Use of the Observation Object	30
	3.31.4.1.2.16	Use of the Note Object Related to the Observation Object.....	31
	3.31.4.1.2.17	Use of the Operator Object.....	31
	3.31.4.1.2.18	Use of the Reagent Object.....	31
90	3.31.4.1.2.19	Use of the Note Object	32
	3.31.4.1.3	Expected Actions	32
	3.31.5	Security Considerations.....	32
	3.32	Accepted Observation Set [LAB-32].....	33
	3.32.1	Scope	33
95	3.32.2	Actor Roles	33
	3.32.3	Referenced Standards	33
	3.32.4	Interaction Diagram.....	34
	3.32.4.1	Messages ORU^R30 and ORU^R31 and their Acknowledgement.....	35
	3.32.4.1.1	Trigger Events.....	35
100	3.32.4.1.2	Message Semantics	35
	3.32.4.1.2.1	Common Static Definition for ORU^R30 and ORU^R31	35
	3.32.4.1.2.2	Usage of MSH segment.....	35
	3.32.4.1.2.3	Usage of ORC Segment.....	35
	3.32.4.1.2.4	Usage of OBR Segment.....	37
105	3.32.4.1.2.5	Static Definition for ACK^R33: Acknowledgement Message.....	39
	3.32.4.1.2.6	Usage of MSA Segment	40
	3.32.4.1.3	Expected Actions	40
	3.32.5	Security Considerations.....	41
	3.33[LAB-xx]	42
110	3.34[LAB-xx]	42
	3.35[LAB-xx]	42

	3.36[LAB-xx].....	42
	3.37[LAB-xx].....	42
	3.38[LAB-xx].....	42
115	3.39Laboratory Code Set Management [LAB-51]	43
	3.39.1 Scope	43
	3.39.2 Actor Roles	43
	3.39.3 Referenced Standards	43
	3.39.4 Interaction Diagram.....	44
120	3.39.4.1 Messages MFN and MFK.....	46
	3.39.4.1.1 Trigger Events.....	46
	3.39.4.1.2 Message Semantics	46
	3.39.4.1.2.1MFN^M08: Full Set of Numeric Observation Codes.....	46
	3.39.4.1.2.2MFN^M09: Full Set of Categorical Observation Codes	46
125	3.39.4.1.2.3MFN^M10: Full Set of Battery Codes	47
	3.39.4.1.2.4MFN^M11: Full Set of Calculated Observation Codes.....	48
	3.39.4.1.2.5MFK: Acknowledgement Message	48
	3.39.4.1.2.6OM1 – General Segment	49
	3.39.4.1.2.7OM2 – Numeric Observation Segment	51
130	3.39.4.1.2.8OM3 Categorical Service/Test/Observation Segment.....	52
	3.39.4.1.2.9OM4 Segment: Observations that Require Specimens.....	53
	3.39.4.1.2.10 OM5 – Observation Batteries.....	54
	3.39.4.1.2.11 MFA - Master File Acknowledgement Segment.....	54
	3.39.4.1.2.12 Batch Message Static Definitions.....	55
135	3.39.4.1.2.13 Batch Message Acknowledgement.....	56
	3.39.4.1.2.14 BHS – Batch Header Segment	58
	3.39.4.1.2.15 BTS – Batch Trailer Segment.....	59
	3.39.4.1.3 Expected Actions	59
	3.39.5 Security Considerations.....	59
140	3.40[LAB-xx].....	60
	3.41[LAB-xx].....	60
	3.42[LAB-xx].....	60
	3.43[LAB-xx].....	60
	3.44Label Delivery Request [LAB-61].....	61
145	3.44.1 Scope	61
	3.44.2 Actor Roles	61
	3.44.3 Referenced Standards	61
	3.44.4 Interaction Diagram.....	62
	3.44.4.1 Message Pair OML^O33 and ORL^O34.....	62
150	3.44.4.1.1 Trigger Events.....	62
	3.44.4.1.2 Message Semantics	62
	3.44.4.1.2.1Static Definition of OML^O33.....	62
	3.44.4.1.2.2Static Definition of ORL^O34.....	63
	3.44.4.1.2.3OBR Segment	64

155	3.44.4.1.3 Expected Actions	66
	3.44.5 Security Considerations.....	66
	3.45 Query for Label Delivery Instruction [LAB-62]	67
	3.45.1 Scope	67
	3.45.2 Actor Roles.....	67
160	3.45.3 Referenced Standards	67
	3.45.4 Interaction Diagram.....	68
	3.45.4.1 Message Pair QBP^SLI^QBP_Q11 and RSP^SLI^RSP_K11	68
	3.45.4.1.1 Trigger Events.....	68
	3.45.4.1.2 Message Semantics	68
165	3.45.4.1.2.1 Query Message Static Definition.....	68
	3.45.4.1.2.2 Response Message Static Definition	69
	3.45.4.1.2.3 QPD Segment (Query Parameters) Static Definition	70
	3.45.4.1.2.4 RCP Segment.....	71
	3.45.4.1.3 Expected Actions	72
170	3.45.5 Security Considerations.....	72
	3.46 Labels and Containers Delivered [LAB-63]	72
	3.46.1 Scope	72
	3.46.2 Actor Roles.....	72
	3.46.3 Referenced Standards	73
175	3.46.4 Interaction Diagram.....	73
	3.46.4.1 Message Pair OML^O33 and ORL^O34	73
	3.46.4.1.1 Trigger Events.....	73
	3.46.4.1.2 Message Semantics	73
	3.46.4.1.2.1 Static Definition of OML^O33	73
180	3.46.4.1.2.2 Static Definition of ORL^O34.....	74
	3.46.4.1.2.3 OBR Segment Static Definition.....	75
	3.46.4.1.3 Expected Actions	77
	3.46.5 Security Considerations.....	77
	Glossary	78
185		

1 Introduction

190 This document, Volume 2c of the IHE Pathology and Laboratory Medicine (PaLM) Technical Framework, defines the transactions of three profiles of the Pathology and Laboratory Medicine domain: the Laboratory Point of Care Testing (LPOCT) Profile, the Laboratory Code Set Distribution (LCSD) Profile and the Laboratory Specimen Barcode Labeling (LBL) Profile.

1.1 Introduction to IHE

195 Integrating the Healthcare Enterprise (IHE) is an international initiative to promote the use of standards to achieve interoperability among health information technology (HIT) systems and effective use of electronic health records (EHRs). IHE provides a forum for care providers, HIT experts and other stakeholders in several clinical and operational domains to reach consensus on standards-based solutions to critical interoperability issues.

200 The primary output of IHE is system implementation guides, called IHE Profiles. IHE publishes each profile through a well-defined process of public review and trial implementation and gathers profiles that have reached final text status into an IHE Technical Framework, of which this volume is a part.

For more general information regarding IHE, refer to www.ihe.net. It is strongly recommended that, prior to reading this volume, the reader familiarizes themselves with the concepts defined in the *IHE Technical Frameworks General Introduction*, which is published on [this page](#).

1.2 Intended Audience

The intended audience of IHE Technical Frameworks Volume 2 is:

- IT departments of healthcare institutions
- 210 • Technical staff of vendors participating in the IHE initiative
- Experts involved in standards development

1.3 Overview of Technical Framework Volume 2

Volume 2 is comprised of several distinct sections:

- Section 1 provides background and reference material.
- 215 • Section 2 presents the conventions used in this volume to define the transactions.
- Section 3 defines Pathology and Laboratory Medicine transactions in detail, specifying the roles for each actor, the standards employed, the information exchanged, and in some cases, implementation options for the transaction.

220 The appendices in Volume 2 provide clarification of technical details of the IHE data model and transactions. A glossary of terms and acronyms used in the IHE Technical Framework, including those from relevant standards, is provided in the *IHE Technical Framework General*

225 *Introduction*, which is published on [this page](#). Due to the length of the document, some domains may divide Volume 2 into smaller volumes labeled 2a, 2b, etc. In this case, the Volume 2 appendices are gathered in Volume 2x. Code and message samples may also be stored on the IHE ftp server. In this case, explicit links to the ftp server will be provided in the transaction text.

1.4 Comment Process

IHE International welcomes comments on this document and the IHE initiative. They can be submitted by sending an email to the co-chairs and secretary of the Pathology and Laboratory Medicine domain committees at palm@ihe.net.

230 1.5 Copyright Licenses

IHE International hereby grants to each Member Organization, and to any other user of these documents, an irrevocable, worldwide, perpetual, royalty-free, nontransferable, nonexclusive, non-sublicensable license under its copyrights in any IHE profiles and Technical Framework documents, as well as any additional copyrighted materials that will be owned by IHE
235 International and will be made available for use by Member Organizations, to reproduce and distribute (in any and all print, electronic or other means of reproduction, storage or transmission) such IHE Technical Documents.

The licenses covered by this Copyright License are only to those copyrights owned or controlled
240 by IHE International itself. If parts of the Technical Framework are included in products that also include materials owned or controlled by other parties, licenses to use those products are beyond the scope of this IHE document and would have to be obtained from that other party.

1.5.1 Copyright of Base Standards

IHE technical documents refer to and make use of a number of standards developed and
245 published by several standards development organizations. All rights for their respective base standards are reserved by these organizations. This agreement does not supersede any copyright provisions applicable to such base standards.

Health Level Seven, Inc. has granted permission to IHE to reproduce tables from the HL7^{®1} standard. The HL7 tables in this document are copyrighted by Health Level Seven, Inc. All rights reserved. Material drawn from these documents is credited where used.

250 The Clinical and Laboratory Standards Institute (CLSI) has granted to IHE the permission to reproduce tables and figures from the POCT1-A standard. The POCT1-A tables and figures in the IHE Pathology and Laboratory Medicine Technical Framework are copyrighted by CLSI. All rights reserved.

IHE grants permission to CLSI to reproduce either parts of the Pathology and Laboratory
255 Medicine Technical Framework.

¹ HL7 is the registered trademark of Health Level Seven International.

1.6 Trademark

IHE® and the IHE logo are trademarks of the Healthcare Information Management Systems Society in the United States and trademarks of IHE Europe in the European Community. They may only be used with the written consent of the IHE International Board Operations Committee, which may be given to a Member Organization in broad terms for any use that is consistent with the IHE mission and operating principles.

1.7 Disclaimer Regarding Patent Rights

Attention is called to the possibility that implementation of the specifications in this document may require use of subject matter covered by patent rights. By publication of this document, no position is taken with respect to the existence or validity of any patent rights in connection therewith. IHE International is not responsible for identifying Necessary Patent Claims for which a license may be required, for conducting inquiries into the legal validity or scope of Patents Claims or determining whether any licensing terms or conditions provided in connection with submission of a Letter of Assurance, if any, or in any licensing agreements are reasonable or non-discriminatory. Users of the specifications in this document are expressly advised that determination of the validity of any patent rights, and the risk of infringement of such rights, is entirely their own responsibility. Further information about the IHE International patent disclosure process including links to forms for making disclosures is available at http://www.ihe.net/Patent_Disclosure_Process. Please address questions about the patent disclosure process to the secretary of the IHE International Board: secretary@ihe.net.

1.8 History of Document Changes

This section provides a brief summary of changes and additions to this document.

Date	Document Revision	Change Summary
July 2016	7.0	Adoption of IHE_TF_Template_Vol2_Rev1.0_2014-07-01, Incorporation of the LAW Profile “Final Text”, Update of the LDA Profile by removal of the transactions transferred to LAW. Incorporation of option “labels & containers delivered” for the LBL Profile. Reorganization of Vol 2 content in 4 volumes: - 2a contains LTW and LDA transactions, - 2b contains LAW transactions and specific appendices, - 2c contains LBL, LPOCT and LCSD transactions - 2x contains common specifications and appendices
June 2017	8.0	One single typo corrected.
August 2018	9.0	LAB-30: Reverse the arrows of Figure 3.30.4-1 (integration of CP 259) Harmonization: LBL Profile references HL7 2.5.1 instead of 2.5 (integration of CP 261)

2 Conventions

This document has adopted the following conventions for representing the framework concepts and specifying how the standards upon which the IHE Technical Framework is based shall be applied.

285 2.1 Transaction Modeling and Profiling Conventions

In order to maintain consistent documentation methods, modeling methods for IHE transactions and profiling conventions for frequently used standards are maintained as an appendix in the *IHE Technical Frameworks General Introduction* published on [this page](#). Methods described include the Unified Modeling Language (UML) and standards conventions include DICOM^{®2}, HL7
290 v2.x, HL7 Clinical Document Architecture (CDA^{®3}) Documents, etc. These conventions are critical to understanding this volume and should be reviewed prior to reading this text.

2.2 Additional Standards Profiling Conventions

Not Applicable

2.3 Use of Coded Entities and Coding Schemes

295 IHE maintains coding schemes in the *IHE Technical Frameworks General Introduction* Appendix published on [this page](#).

² DICOM is the registered trademark of the National Electrical Manufacturers Association for its standards publications relating to digital communications of medical information.

³ CDA is the registered trademark of Health Level Seven International.

3 IHE Transactions

300 This section defines each IHE Pathology and Laboratory Medicine transaction in detail, specifying the standards used and the information transferred.

3.30 Initiate POCT on a patient specimen [LAB-30]

This transaction is used on a persistently connected POCRG implementing the option *Patient Identity Checking* of the LPOCT Profile.

3.30.1 Scope

305 The point of care devices often work with a patient (or visit) identifier scanned or typed on their user interface. The purpose of this transaction is to provide a real-time control of this patient/visit identifier, and to avoid any risks of mistyping.

310 This transaction is used by a POCRG in a ward to inform the POCDM that a new point of care set of tests is about to start on a patient specimen. The POCRG delivers the relevant information related to the testing, including a patient/visit identifier. The POCDM checks the information received, and particularly verifies that the patient/visit identifier is associated with this ward. It then sends back an acknowledgement carrying either the patient's name or a textual error (e.g., "Patient unknown"). The POCRG displays the information received in the acknowledgement, enabling the operator to check that he is testing on the right patient.

315 3.30.2 Actor Roles

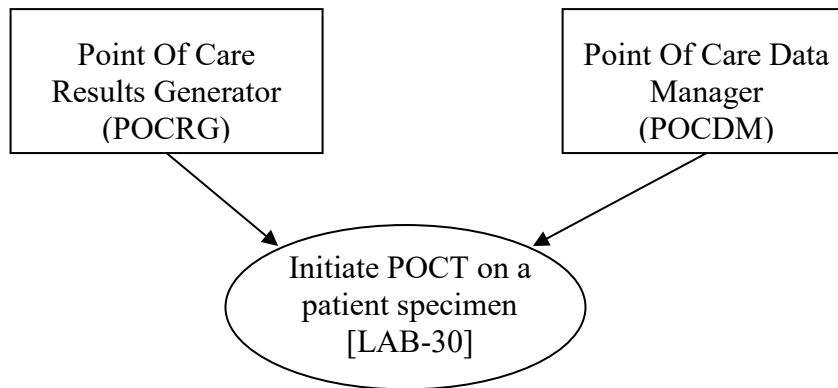

Figure 3.30.2-1: Use Case Diagram

320

Table 3.30.2-1: Actor Roles

Actor:	Point Of Care Results Generator (POCRG)
Role:	Informs the POCDM that a new set of tests is starting, giving all relevant information related to this point of care testing. Waits for the patient identity in the acknowledgement, and displays this identity on its user interface.
Actor:	Point Of Care Data Manager (POCDM)
Role:	Checks the information received related to the point of care testing, searches for the patient data related to the patient identifier received, and sends an acknowledgement back to the PCRGR. The acknowledgement carries either the patient’s name, or an error (e.g., “Test unauthorized on this device”)

3.30.3 Referenced Standards

POCT1-A: Device Message Layer (DML) defined in Appendix B of POCT1-A standard.

In the POCT1-A standard, the PCRGR of IHE is called the *Device* and the POCDM of IHE is called the *Observation Reviewer*.

325 This transaction [LAB-30] uses the *Continuous Mode* defined in Section 4.2 of Appendix B of POCT1-A. This continuous mode is usable if the PCRGR has a persistent link with the POCDM, which is the prerequisite for using transaction [LAB-30].

3.30.4 Interaction Diagram

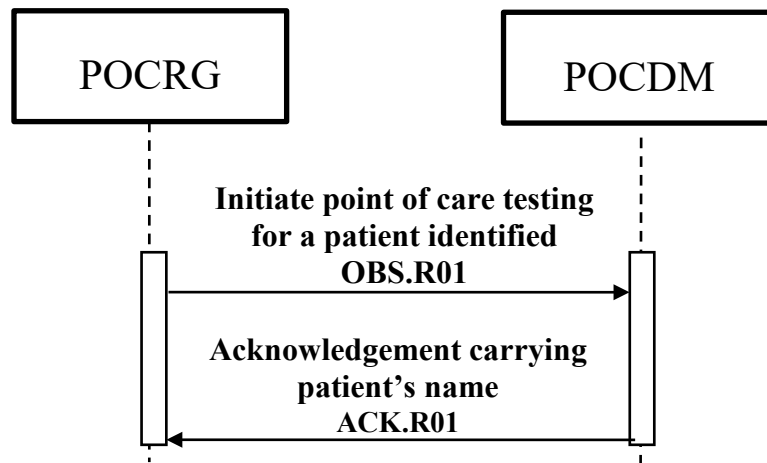

330

Figure 3.30.4-1: Interaction Diagram for Transaction LAB-30

3.30.4.1 Message OBS.R01 and its acknowledgement ACK.R01

The POCT1-A standard currently does not describe this interaction for real-time patient identity checking. Transaction [LAB-30] uses as initial message a “patient-related observation message”

335 OBS.R01 as defined in POCT1-A Appendix B. The status of the Service object is valued to “INI” (as “initiate a point of care testing”), and no results is provided in the message. This value “INI” is added by IHE to the table of service status defined in POCT1-A.

The Acknowledgement message ACK.R01 from the POCDM to the POCRG, carries the patient’s name as a note related to the acknowledgement, within the note_txt field of the Acknowledgement object.

340 The two messages are exchanged within an “*Observations*” *Topic* within the *Continuous Mode* of POCT1-A Device Messaging Level.

3.30.4.1.1 Trigger Events

345 An operator (caregiver or patient) sets a patient specimen on the point of care device (the POCRG supporting the option “Patient identity checking”), and enters relevant information including the operator’s ID and the patient’s ID. This triggers the initial message of Transaction LAB30: “Initiate POCT on a patient specimen”.

3.30.4.1.2 Message Semantics

3.30.4.1.2.1 Message OBS.R01, status_cd = ‘INI’

350 The figure below describes the use of message OBS.R01 in this transaction. It respects the formalism of POCT1-A, Annex B.

OBJECT MODEL	XML DTD FRAGMENT
<p>Header</p> <ul style="list-style-type: none"> -message_type : CV +control_id : ST +version_id : ST +creation_dttm: TS -encoding_chars: ST <p>Service</p> <ul style="list-style-type: none"> +role_cd : CS +observation_dttm: TS -status_cd: CS -reason_cd: CS -sequence_nbr: INT <p>Patient</p> <ul style="list-style-type: none"> +patient_id : ST -location_dttm: ST -name: PN -birth_date: TS -gender_cd: CS -weight: PQ -height: PQ <p>Operator [0..1]</p> <ul style="list-style-type: none"> +operator_id : ST -name: PN <p>Order [0..1]</p> <ul style="list-style-type: none"> +universal_service_id : CE -ordering_provider_id: ST -order_id: CV <p>Specimen [0..1]</p> <ul style="list-style-type: none"> +specimen_dttm : TS -specimen_id: CV -source_cd: CE -type_cd: CE 	<pre> <!ELEMENT OBS.R01 (HDR, SVC+)> <!ELEMENT HDR (HDR.message_type?, HDR.control_id, HDR.version_id, HDR.creation_dttm, HDR.encoding_chars?)> <!ELEMENT SVC (SVC.role_cd, SVC.observation_dttm, SVC.status_cd?, SVC.reason_cd?, SVC.sequence_nbr ?, PT, OPR?, ORD?, SPC?)> <!ELEMENT PT (PT.patient_id, PT.location?, PT.name?, PT.birth_date?, PT.gender_cd ?, PT.weight?, PT.height?)> <!ELEMENT OPR (OPR.operator_id, OPR.name?)> <!ELEMENT ORD (ORD.universal_service_id, ORD.ordering_provider_id?, ORD_order_id?)> <!ELEMENT SPC (SPC.specimen_dttm, SPC.specimen_id?, SPC.source_cd?, SPC.type_cd?)> </pre>

Figure 3.30.4.1.2.1-1: Message OBS.R01 in Transaction LAB-30

3.30.4.1.2.2 Use of the Service Object

One and only one occurrence of this object must appear in the context of transaction [LAB-30].

355

Attribute	Data Type	IHE Usage	IHE Cardinalities	Description
role_cd	CS	R	[1..1]	Value "OBS": Patient test observation
observation_dttm	TS	R	[1..1]	Starting date/time of the test
status_cd	ST	R	[1..1]	Value "INI": The point of care test is about to start. No observation produced yet.
reason_cd	ST	X	[0..0]	This code is not used in the context of [LAB-30].
sequence_nbr	ST	X	[0..0]	This number is not used in the context of [LAB-30].

Table 48 of POCT1-A: Service Status code Field Values

Code	Meaning	Description
NRM	Normal	This test was performed under normal conditions.
OVR	Override	This test was performed in an 'override' or 'stat' circumstance. Some normal procedures (e.g., QC) may not have been followed.
UNK	Unknown	It is not known under what circumstances this test was performed.
INI	Test starting	This test is going to start for this patient. Value added by IHE to this table.

The last value "INI" is added by this IHE transaction.

3.30.4.1.2.3 Use of the Patient Object

One and only one occurrence of this object must appear in the context of transaction [LAB-30].

360

Attribute	Data Type	IHE Usage	IHE Cardinalities	Description
patient_id	ST	R	[1..1]	A unique identifier for the patient, supposed to be known from the POCDM.
location	ST	RE	[0..1]	Location of the patient.
name	PN	X	[0..0]	Patient name. Not used in the context of [LAB-30].
birth_date	TS	X	[0..0]	Patient date of birth. Not used in the context of [LAB-30].
gender_cd	CS	X	[0..0]	Patient gender. Not used in the context of [LAB-30].
weight	PQ	X	[0..0]	Patient weight. Not used in the context of [LAB-30].
height	PQ	X	[0..0]	Patient height. Not used in the context of [LAB-30].

3.30.4.1.2.4 Use of the Operator Object

One and only one occurrence of this object must appear in the context of transaction [LAB-30].

Attribute	Data Type	IHE Usage	IHE Cardinalities	Description
operator_id	ST	R	[1..1]	A unique identifier for the operator
name	PN	RE	[0..1]	Operator's name. Required if available on the POCRG.

3.30.4.1.2.5 Use of the Order Object

365 Zero or one occurrence of this object may appear in the context of transaction [LAB-30].

Attribute	Data Type	IHE Usage	IHE Cardinalities	Description
universal_service_id	CE	R	[1..1]	Identifies the service provided by these observations. LOINC is the preferred encoding scheme. The CE data type allows transmission of two encodings, if appropriate.
ordering_provider_id	ST	RE	[0..1]	An identifier that uniquely identifies the provider who ordered this service.
order_id	CV	O	[0..1]	An identifier that uniquely identifies this service instance. This field may contain an order id, accession number, or other such identifier.

3.30.4.1.2.6 Use of the Specimen object

Zero or one occurrence of this object may appear in the context of transaction [LAB-30].

Attribute	Data Type	IHE Usage	IHE Cardinalities	Description
specimen_dttm	TS	R	[1..1]	Time the specimen was drawn.
specimen_id	CV	O	[0..1]	Code identifying the specimen.
source_cd	CE	O	[0..1]	Location of the specimen. Coded in table 51 of POCT1-A.
type_cd	CE	O	[0..1]	Type of the specimen. Coded in table 52 of POCT1-A.

370 **3.30.4.1.2.7 Example Message OBS.R01: Initiate POCT on a Patient Specimen**

```
<OBS.R01>
  <HDR>
    <HDR.control_id V="12345"/>
    <HDR.version_id V="POCT1"/>
    <HDR.creation_dttm V="2005-05-16T16:30:00+01:00"/>
  </HDR>
  <SVC>
    <SVC.role_cd V="OBS"/>
    <SVC.observation_dttm V="2005-05-16T16:30:00+01:00"/>
    <SVC.status_cd V="INI"/>
    <PT>
      <PT.patient_id V="888888"/>
    </PT>
    <OPR>
      <OPR.operator_id V="Nurse007"/>
      <OPR.name V="Nancy Nursery">
        <GIV V="Nancy"/>
        <FAM V="Nursery"/>
      </OPR.name>
    </OPR>
    <ORD>
      <ORD.universal_service_id V="BG-OXI-ELECT"/>
      <ORD.ordering_provider_id V="Facility1"/>
    </ORD>
  </SVC>
</OBS.R01>
```

375 In this example, the operator Nancy Nursery wants to start a blood gas test on a patient specimen for a patient whose enterprise id is « 888888 ». The device is in a hospital in Palermo one hour ahead GMT.

3.30.4.1.2.8 Acknowledgement with Patient Name – Message ACK.R01

The figure below is extracted from POCT1-A, Annex B.

OBJECT MODEL	XML DTD FRAGMENT											
<table border="1"> <tr> <td>Header</td> </tr> <tr> <td>-message_type : CV</td> </tr> <tr> <td>+control_id : ST</td> </tr> <tr> <td>+version_id : ST</td> </tr> <tr> <td>+creation_dttm : TS</td> </tr> <tr> <td>-encoding_chars : ST</td> </tr> <tr> <td>Acknowledgement</td> </tr> <tr> <td>+type_cd : CS</td> </tr> <tr> <td>+ack_control_id : ST</td> </tr> <tr> <td>-note_txt : ST</td> </tr> <tr> <td>-error_detail_cd : CV</td> </tr> </table>	Header	-message_type : CV	+control_id : ST	+version_id : ST	+creation_dttm : TS	-encoding_chars : ST	Acknowledgement	+type_cd : CS	+ack_control_id : ST	-note_txt : ST	-error_detail_cd : CV	<pre><!ELEMENT ACK.R01 (HDR, ACK)> <!ELEMENT HDR (HDR.message_type?, HDR.control_id, HDR.version_id, HDR.creation_dttm, HDR.encoding_chars?)> <!ELEMENT ACK (ACK.type_cd, ACK.ack_control_id, ACK.note_txt?, ACK.error_detail_cd?)></pre>
Header												
-message_type : CV												
+control_id : ST												
+version_id : ST												
+creation_dttm : TS												
-encoding_chars : ST												
Acknowledgement												
+type_cd : CS												
+ack_control_id : ST												
-note_txt : ST												
-error_detail_cd : CV												

3.30.4.1.2.9 Use of the Header Object

Attribute	Data Type	IHE Usage	IHE Cardinalities	Description
message_type	CV	X	[0..0]	Not used: Redundant with the root element of the message
control_id	ST	R	[1..1]	unique identifier of the instance of this acknowledgement message
version_id	ST	R	[1..1]	“POCT1”
creation_dttm	TS	C	[0..1]	date/time of creation of this acknowledgement

380

3.30.4.1.2.10 Use of the Acknowledgement Object

Attribute	Data Type	IHE Usage	IHE Cardinalities	Description
type_cd	CS	R	[1..1]	AA: Application Accept AE: Application Error
ack_control_id	ST	R	[1..1]	The unique identifier of the acknowledged message
note_txt	ST	R	[1..1]	This field is required in the context of IHE transaction [LAB-30]. It contains either the patient’s name in case of Application Accept or a text describing the error condition in case of Application Error.
error_detail_cd	CV	R	[1..1]	A code detailing the error. Described in Table 14 of Annex B of POCT1-A.

Condition predicate for the field **note_txt**:

385

If the POCDM has matched an existing patient, and has controlled that the information received within the OBS.R01 message is consistent with this patient and that the test for this patient on this device by this operator is authorized, then the POCDM sends back a positive acknowledgement (type_cd = “AA”, error_detail_cd = “0”). In this case, the note_txt is required and shall be valued with the patient’s name, using any display oriented string format.

Example of positive acknowledgement for patient Jeanne DUPONT:

```
<ACK.R01>
  <HDR>
    < HDR.control_id V="45678"/>
    < HDR.version_id V="POCT1"/>
    < HDR.creation_dttm V="2005-05-16T16:30:00"/>
  </HDR>
  <ACK>
    < ACK.type_cd V="AA"/>
    < ACK.ack_control_id V="12345"/>
    < ACK.note_txt V=" DUPONT Jeanne "/>
    < ACK.error_detail_cd V="0"/>
  </ACK>
</ACK.R01>
```

390

If the POCDM has failed to match a patient from the patient identifier received within the OBS.R01 message, then it sends back a negative acknowledgement (type_cd = "AA", error_detail_cd = "202"), with the field note_txt containing a text explaining the error condition.

Example of negative acknowledgement:

```
<ACK.R01>
  <HDR>
    < HDR.control_id V="45679"/>
    < HDR.version_id V="POCT1"/>
    < HDR.creation_dttm V="2005-05-16T16:30:00"/>
  </HDR>
  <ACK>
    < ACK.type_cd V="AE"/>
    < ACK.ack_control_id V="12345"/>
    < ACK.note_txt V=" Unknown patient identifier 888888"/>
    < ACK.error_detail_cd V="202"/>
  </ACK>
</ACK.R01>
```

395

3.30.4.1.3 Expected Actions

When receiving the message "Initiate POCT on a patient specimen", the POCDM SHALL search for the patient using the patient ID, and SHALL check the information related to the testing. Then the POCDM builds its Acknowledgement message and sends it to the POCRG.

400 When receiving the message "Acknowledgement with patient identity", the POCRG SHALL display as much of the patient identity as possible, to allow the operator to verify this identity of the patient.

3.30.5 Security Considerations

None.

405 **3.31 Produced Observation Set [LAB-31]**

3.31.1 Scope

3.31.2 Actor Roles

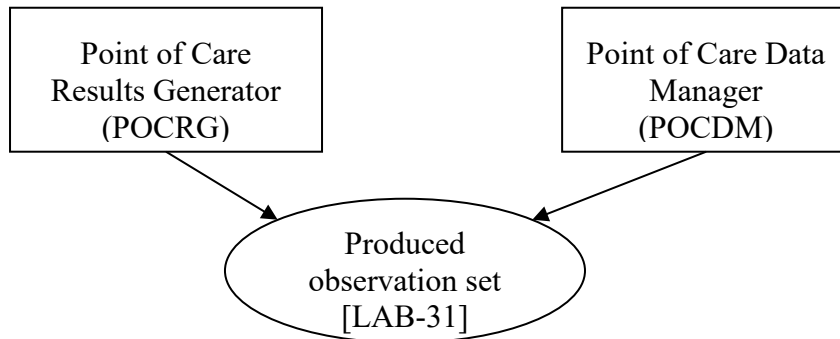

Figure 3.31.2-1: Use Case Diagram

410

Table 3.31.2-1: Actor Roles

Actor:	Point Of Care Results Generator (POCRG)
Role:	Sends to the POCDM a new set of observations obtained on a patient specimen or a QC specimen. Waits for the acknowledgement of this set of observations
Actor:	Point Of Care Data Manager (POCDM)
Role:	Checks the information received with this set of observations, controls the results against its own business rules, accepts them or rejects them, stores the accepted results. Sends acknowledgement of the observation set back to the PCRGR.

3.31.3 Referenced Standards

POCT1-A: Device Message Layer (DML) defined in Appendix B.

This LPOCT Profile describes the upper-layer messaging protocol (DML) of POCT1-A. The PCRGR of IHE is called the “*Device*” in POCT1-A. The POCDM of IHE is called “*Observation Reviewer*” in POCT1-A.

415

This transaction [LAB-31] can be used on the *Basic Profile* defined in Section 4.1 of Appendix B of POCT1-A, or on the *Continuous Mode* defined in Section 4.2 of the same document.

3.31.4 Interaction Diagram

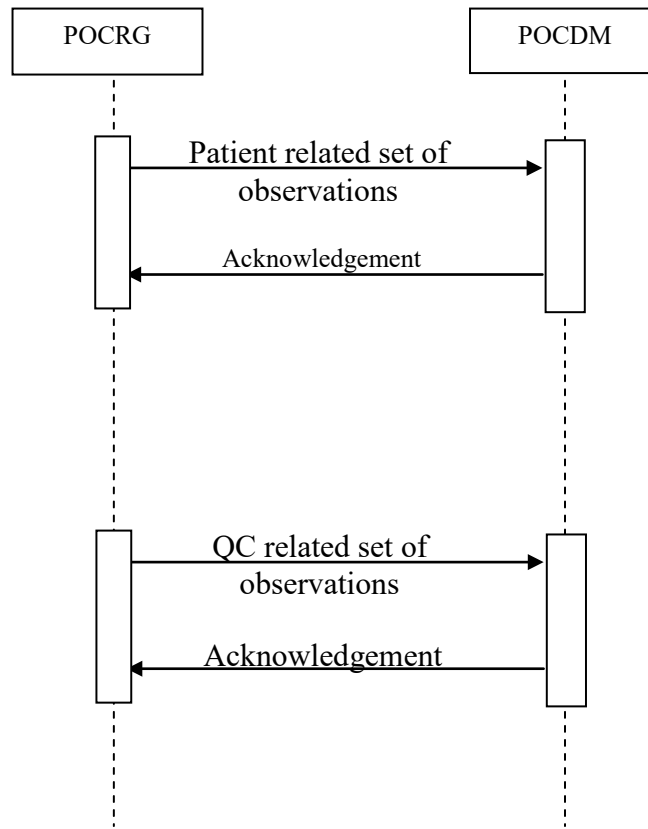

420

Figure 3.31.4-1: Interaction Diagram for Transaction LAB-31

The message “Patient related set of observations” of the diagram above uses the Observations message **OBS.R01** defined in Appendix B – Section 6.10 of POCT1-A.

425 The message “QC related set of observations” uses the Observations message **OBS.R02** defined in the same Section of POCT1-A.

3.31.4.1 Messages **OBS.R01** and **OBS.R02**

3.31.4.1.1 Trigger Events

The “Patient related set of observations” message is triggered by any new patient observations obtained on the POCRG.

430 The “QC related set of observations” message is triggered by any new non-patient observations (internal or external QC, calibration) obtained on the POCRG.

When using the “*Continuous Mode*” of POCT1-A, the above events trigger the Observations messages at once.

435 When using the “*Basic Profile*” of POCT1-A, the sending of these Observation messages
requires these prior conditions:

1. Establishment of a *Conversation* between POCRG and POCDM. (*Topic Hello*)
2. The sending of the message “Device status” by the POCRG and its acknowledgement by
the POCDM. (*Topic Device Status*)
- 440 3. The sending of the message “Request Observations” by the POCDM to the POCRG (if
the Conversation is not in continuous mode).

3.31.4.1.2 Message Semantics

3.31.4.1.2.1 Message OBS.R01: Patient-Related Set of Observations

The figure below is extracted from POCT1-A, Annex B.

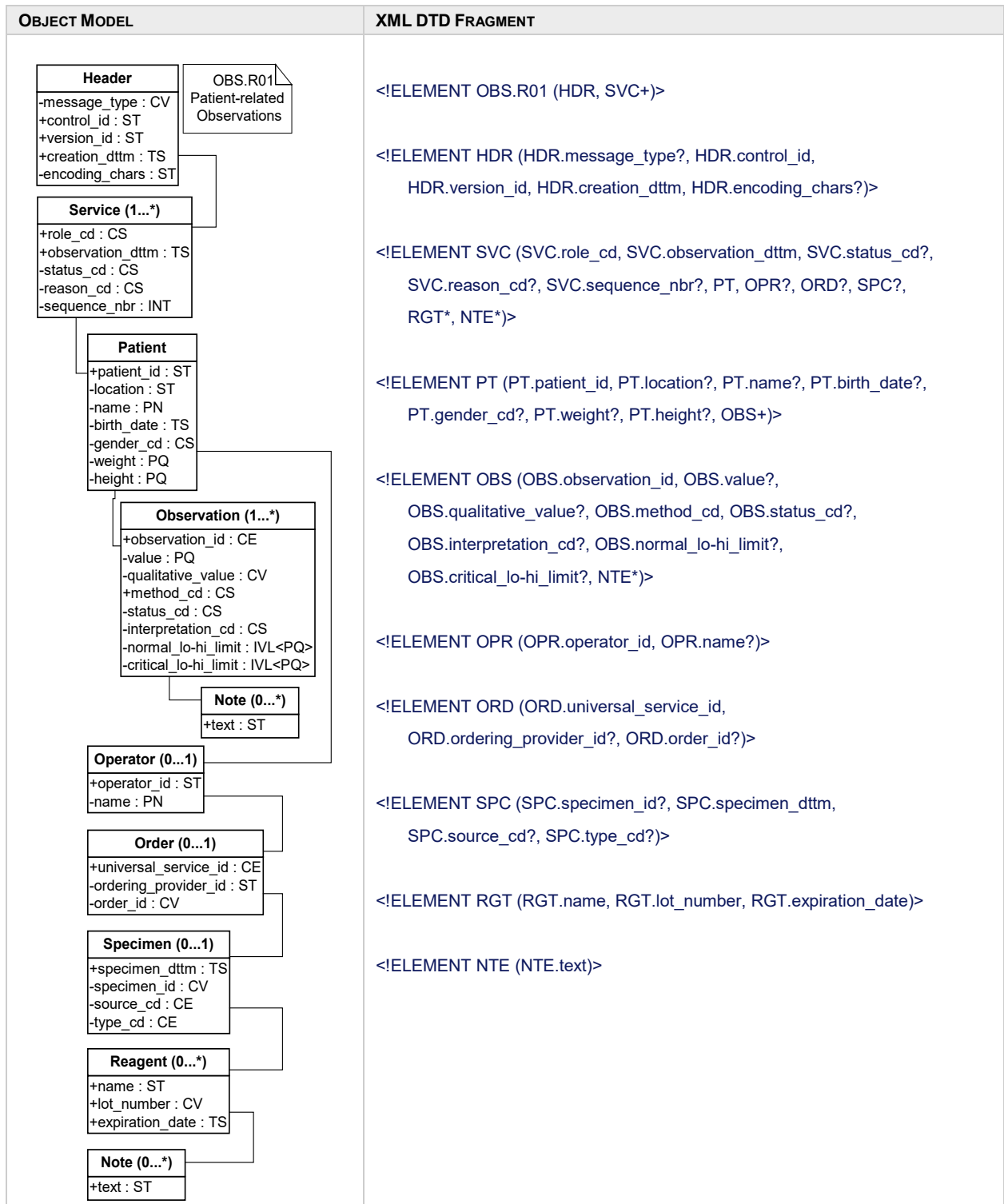

Figure 3.31.4.1.2.1-1: Patient-Related Observation Message Model, POCT1-A – Appendix B

3.31.4.1.2.2 Use of the Service Object

Attribute	Data Type	IHE Usage	IHE Cardinalities	Description
role_cd	CS	R	[1..1]	Value “OBS”: Patient test observation
observation_dttm	TS	R	[1..1]	production date/time of this set of observations
status_cd	ST	R	[1..1]	One of the values listed in table 48 of POCT1-A, Annex B.
reason_cd	ST	R	[1..1]	One of the values listed in table 49 of POCT1-A, Annex B.
sequence_nbr	ST	O	[0..1]	An optional number to indicate the position of this service in a historical list of services performed by this Device. This number is unique only across a single Device, and may wrap (e.g., a ‘use counter’).

Table 48 of POCT1-A: Service Status code Field Values

Code	Meaning	Description
NRM	Normal	This test was performed under normal conditions
OVR	Override	This test was performed in an ‘override’ or ‘stat’ circumstance. Some normal procedures (e.g., QC) may not have been followed.
UNK	Unknown	It is not known under what circumstances this test was performed.

Table 49 of POCT1-A: Service Reason Code Field Values

Code	Meaning	Description
NEW	New	<u>Default</u> . This is a new set of observations.
RES	Resent	This set of observations is being resent.
EDT	Edited	Some fields of this set of observations have been edited since last transmission

3.31.4.1.2.3 Use of the Patient Object

450 One and only one occurrence of Patient per Service:

Attribute	Data Type	IHE Usage	IHE Cardinalities	Description
patient_id	ST	R	[1..1]	A unique identifier for the patient, supposed to be known from the POCDM.
location	ST	RE	[0..1]	Location of the patient. Required if known.
name	PN	RE	[0..1]	Patient name. Required if known.
birth_date	TS	RE	[0..1]	Patient date of birth. Required if known.
gender_cd	CS	RE	[0..1]	Patient gender. Required if known.
weight	PQ	C	[0..1]	Patient weight. Required if known and relevant for the test.
height	PQ	C	[0..1]	Patient height. Required if known and relevant for the test.

3.31.4.1.2.4 Use of the Observation Object

One or more occurrences of Observation per Patient:

Attribute	Data Type	IHE Usage	IHE Cardinalities	Description
observation_id	CE	R	[1..1]	The test identifier, preferably coded with LOINC
value	PQ	C	[0..1]	The observation result, if expressed quantitatively (i.e., a numerical value with units).
qualitative_value	CV	C	[0..1]	The observation result, if expressed qualitatively. POCT1-A, Annex B provides a list of codes in table 35. This list is extensible.
method_cd	CS	R	[1..1]	Origin of the result. Coded in table 36 of POCT1-A, Annex B. This LPOCT Profile authorizes only these values: C = Calculated (The value was calculated) D = Default (The value is a default value) E = Estimated I = Input (The value was externally input to the POCRG) M = Measured (The value was measured on the POCRG)
status_cd	CS	R	[1..1]	Status of the result. Coded in table 37 of POCT1-A, Annex B. This IHE LPOCT Profile authorizes only this value for patient-related results: A = Accepted
interpretation_cd	CS	C	[0..1]	Interpretation of the result (abnormal flags). Coded in table 38 of POCT1-A, Annex B: L = below low normal H = above high normal LL = below lower panic limits HH = above upper panic limits < = below absolute low-off instrument scale > = above absolute high-off instrument scale N = normal A = abnormal (applies to nonnumeric results) AA = very abnormal (applies to nonnumeric results) null = no range defined or normal ranges don't apply U = significant change up D = significant change down B = better (use when direction not relevant) W = worse (use when direction not relevant)
normal_lo-hi_limit	IVL<PQ>	R	[1..1]	The low and high limit range for a normal result
critical_lo-hi_limit	IVL<PQ>	R	[1..1]	The low and high limit range outside which clinical review is required

Condition predicate for fields *value*, *qualitative_value* and *interpretation_cd*:

- 455 Every Observation object instance must contain either a *value* or a *qualitative_value* field. The *interpretation_cd* field may be used to provide additional information about the quantitative or qualitative value.

3.31.4.1.2.5 Use of the Note Object Related to the Observation Object

460 Zero or one occurrence of this object may appear below an observation. The note is a comment related to the observation.

Attribute	Data Type	IHE Usage	IHE Cardinalities	Description
text	ST	R	[1..1]	Comment of the observation

3.31.4.1.2.6 Use of the Operator Object

One and only one occurrence.

Attribute	Data Type	IHE Usage	IHE Cardinalities	Description
operator_id	ST	R	[1..1]	A unique identifier for the operator
name	PN	RE	[0..1]	Operator's name. Required if available on the POCRG.

3.31.4.1.2.7 Use of the Order Object

465 One and only one occurrence.

Attribute	Data Type	IHE Usage	IHE Cardinalities	Description
universal_service_id	CE	R	[1..1]	Identifies the service provided by these observations. LOINC is the preferred encoding scheme. The CE data type allows transmission of two encodings, if appropriate.
ordering_provider_id	ST	RE	[0..1]	An identifier that uniquely identifies the provider who ordered this service.
order_id	CV	O	[0..1]	An identifier that uniquely identifies this service instance. This field may contain an order id, accession number, or other such identifier.

3.31.4.1.2.8 Use of the Specimen Object

Zero or one occurrence.

Attribute	Data Type	IHE Usage	IHE Cardinalities	Description
specimen_dttm	TS	R	[1..1]	Time the specimen was drawn.
specimen_id	CV	O	[0..1]	Code identifying the specimen.
source_cd	CE	O	[0..1]	Location of the specimen. Coded in table 51 of POCT1-A, Annex B.
type_cd	CE	R	[1..1]	Type of the specimen. Coded in table 52 of POCT1-A, Annex B.

3.31.4.1.2.9 Use of the Reagent Object

Zero or one occurrence.

Attribute	Data Type	IHE Usage	IHE Cardinalities	Description
name	ST	RE	[0..1]	The manufacturer's name for the reagent
lot_number	CV	R	[1..1]	The lot number of reagent used
expiration_date	TS	RE	[0..1]	The date past which the reagent should not be used

470

3.31.4.1.2.10 Use of the Note Object

Zero or more occurrences of this object may appear below the Service object. The note is a comment related to the service (i.e., the set of observations).

Attribute	Data Type	IHE Usage	IHE Cardinalities	Description
text	ST	R	[1..1]	Comment of the observation

3.31.4.1.2.11 Example of Patient-Related Observations Message

```

<OBS.R01>
  <HDR>
    <HDR.control_id V="12345"/>
    <HDR.version_id V="POCT1"/>
    <HDR.creation_dttm V="2005-05-16T16:30:00+1:00"/>
  </HDR>
  <SVC>
    <SVC.role_cd V="OBS"/>
    <SVC.observation_dttm V="2005-05-16T16:30:00+1:00"/>
    <SVC.status_cd V="NRM"/>
    <SVC.reason_cd V="NEW"/>
  <PT>
    <PT.patient_id V="888888"/>
    <PT.location V="ICU-Bed3"/>
    <PT.name V="Pat Patient">
      <GIV V="Patrick"/>
      <FAM V="Patient"/>
    </PT.name>
    <PT.birth_date V="1958-10-31"/>
    <PT.gender_cd V="M"/>
  <OBS>
    <OBS.observation_id V="2703-7" SN="LN" DN="Oxygen"/>
    <OBS.value V="110" U="mmHg"/>
    <OBS.method_cd V="M"/>
    <OBS.status_cd V="A"/>
    <OBS.interpretation_cd V="H"/>
    <OBS.normal_lo-hi_limit V="[83;108]" V="mmHg"/>
    <OBS.critical_lo-hi_limit V="[40;130]" V="mmHg"/>
  </OBS>
  <OBS>
    <OBS.observation_id V="11557-6" SN="LN" DN="Carbon Dioxide"/>
    <OBS.value V="33.2" U="mmHg"/>
    <OBS.method_cd V="M"/>
    <OBS.status_cd V="A"/>
    <OBS.interpretation_cd V="L"/>
    <OBS.normal_lo-hi_limit V="[35.0;48.0]" V="mmHg"/>
    <OBS.critical_lo-hi_limit V="[20.0;60.0]" V="mmHg"/>
  </OBS>
  <NTE>
    <NTE.text V="result below reference ranges, within critical ranges"/>
  </NTE>
  <OBS>
    <OBS.observation_id V="11558-4" SN="LN" DN="pH"/>
    <OBS.value V="7.47"/>
    <OBS.method_cd V="M"/>
    <OBS.status_cd V="A"/>
    <OBS.interpretation_cd V="H"/>
    <OBS.normal_lo-hi_limit V="[7.35;7.45]" V="mmHg"/>
    <OBS.critical_lo-hi_limit V="[7.00;7.60]" V="mmHg"/>
  </OBS>
  <PT>
  <OPR>
    <OPR.operator_id V="Nurse007"/>
    <OPR.name V="Nancy Nursery">
      <GIV V="Nancy"/>
      <FAM V="Nursery"/>
    </OPR.name>
  </OPR>
  <ORD>
    <ORD.universal_service_id V="BG-OXI-ELECT"/>
    <ORD.ordering_provider_id V="Facility1"/>
  </ORD>
  <SPC>
    <SPC.specimen_dttm V="2005-05-19T10:20:00-1:00"/>
    <SPC.source_cd V="LLFA"/>
    <SPC.type_cd V="BLDA"/>
  </SPC>
  <NTE>
    <NTE.text V="Battery approved by Dr Escalpios"/>
  </NTE>
</SVC>
</OBS.R01>

```

Figure 3.31.4.1.2.11-1: Example of Patient-Related Observation Message

3.31.4.1.2.12 Message OBS.R02: QC-Related Set of Observations

The figure below is extracted from POCT1-A, Annex B.

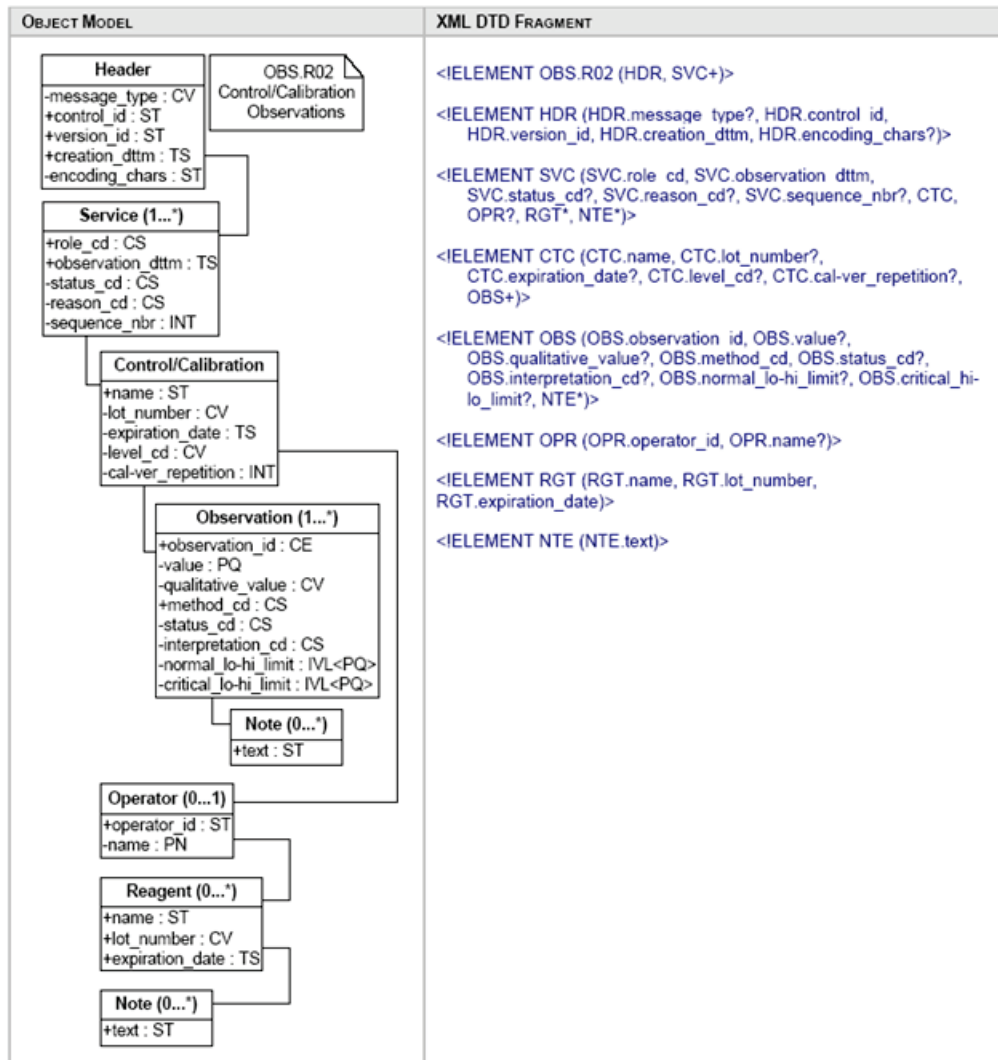

480

Figure 3.31.4.1.2.12-1: QC-Related Observation Message Model, POCT1-A – Appendix B

3.31.4.1.2.13 Use of the Service Object

Attribute	Data Type	IHE Usage	IHE Cardinalities	Description
role_cd	CS	R	[1..1]	The following values are authorized within OBS.R02 message, taken from table 47 in POCT1-A, Annex B:

Attribute	Data Type	IHE Usage	IHE Cardinalities	Description
				LQC = Liquid QC (observation from a liquid QC test) EQC = Electronic QC (observation from an electronic QC test) CVR = Calibration verification CAL = Calibration PRF = Proficiency test
observation_dttm	TS	R	[1..1]	Production date/time of this set of observations.
status_cd	ST	R	[1..1]	One of the values listed in table 48 of POCT1-A, Annex B.
reason_cd	ST	R	[1..1]	One of the values listed in table 49 of POCT1-A, Annex B.
sequence_nbr	ST	O	[0..1]	An optional number to indicate the position of this service in a historical list of services performed by this Device. This number is unique only across a single Device, and may wrap (e.g., a ‘use counter’).

3.31.4.1.2.14 Use of the Control/Calibration Object

One and only one occurrence of Control/Calibration per Service:

Attribute	Data Type	IHE Usage	IHE Cardinalities	Description
name	ST	RE	[0..1]	The manufacturer’s name for the QC/Calibration material
lot_number	CV	R	[1..1]	The vendor-specific lot number of the QC/Calibration material
expiration_date	TS	RE	[0..1]	The date past which the reagent should not be used
level_cd	CV	C	[0..1]	The level for the QC test or for the calibration verification test. Not applicable to proficiency tests nor to calibration tests.
cal-ver_repetition	INT	C	[0..1]	Only applicable to calibration verification: If tests within a linearity sequence are repeated at a given level, this field indicates the repetition count for this particular test.

485 3.31.4.1.2.15 Use of the Observation Object

At least one occurrence of Observation below Control/Calibration:

Attribute	Data Type	IHE Usage	IHE Cardinalities	Description
observation_id	CE	R	[1..1]	The test identifier, preferably coded with LOINC.
value	PQ	C	[0..1]	The observation result, if expressed quantitatively (i.e., a numerical value with units).
qualitative_value	CV	C	[0..1]	The observation result, if expressed qualitatively.
method_cd	CS	R	[1..1]	Origin of the result. Coded in table 36 of POCT1-A, Annex B. This LPOCT Profile authorizes only these values: C = Calculated (The value was calculated) D = Default (The value is a default value) E = Estimated I = Input (The value was externally input to the POCRG) M = Measured (The value was measured on the POCRG)

Attribute	Data Type	IHE Usage	IHE Cardinalities	Description
status_cd	CS	R	[1..1]	Status of the result. Coded in table 36 of POCT1-A, Annex B. This LPOCT Profile authorizes only these values for patient-related results: A = Accepted D = Discarded R = Rejected
interpretation_cd	CS	C	[0..1]	Interpretation of the result (abnormal flags). Coded in table 38 of POCT1-A, Annex B.
normal_lo-hi_limit	IVL<PQ>	RE	[0..1]	The low and high limit range for a normal result.
critical_lo-hi_limit	IVL<PQ>	RE	[0..1]	The low and high limit range outside which clinical review is required.

Condition predicate for fields *value*, *qualitative_value* and *interpretation_cd*:

490 Every Observation object instance must contain either a value or a qualitative_value field. The interpretation_cd field may be used to provide additional information about the quantitative or qualitative value.

3.31.4.1.2.16 Use of the Note Object Related to the Observation Object

Zero or one occurrence of this object may appear below an observation. The note is a comment related to the observation.

Attribute	Data Type	IHE Usage	IHE Cardinalities	Description
text	ST	R	[1..1]	Comment of the observation

495 3.31.4.1.2.17 Use of the Operator Object

One and only one occurrence.

Attribute	Data Type	IHE Usage	IHE Cardinalities	Description
operator_id	ST	R	[1..1]	A unique identifier for the operator
name	PN	RE	[0..1]	Operator's name. Required if available on the POCRG.

3.31.4.1.2.18 Use of the Reagent Object

Zero or one occurrence.

Attribute	Data Type	IHE Usage	IHE Cardinalities	Description
name	ST	RE	[0..1]	The manufacturer's name for the reagent
lot_number	CV	R	[1..1]	The lot number of reagent used
expiration_date	TS	RE	[0..1]	The date past which the reagent should not be used

3.31.4.1.2.19 Use of the Note Object

500 Zero or more occurrences of this object may appear below the Service object. The note is a comment related to the service (i.e., the set of observations).

Attribute	Data Type	IHE Usage	IHE Cardinalities	Description
text	ST	R	[1..1]	Comment of the observation

3.31.4.1.3 Expected Actions

505 The POCDM receiving a message OBS.R01 (patient related observations) must check this set of observations against its own configuration rules (comparison with normal ranges, QC performed and OK, operator allowed to proceed, patient known in this point of care ...). It then accepts or rejects this set of observations, and sends its reply in an Acknowledgement message. If the set of observations was accepted, the POCDM stores it in its data base. Then the POCDM initiates a transaction [LAB-32] with the Order Filler to forward this accepted set of observations.

510 The POCDM receiving a message OBS.R02 (non-patient related observations) must check this set of observations against its own configuration rules. It then accepts or rejects this set of observations, and sends its reply in an Acknowledgement message. If the set of observations (QC or calibration results) was accepted, the POCDM stores it in its data base.

3.31.5 Security Considerations

None.

515

3.32 Accepted Observation Set [LAB-32]

3.32.1 Scope

The POCDM forwards all accepted sets of patient observations to the Order Filler, so that they can be consolidated with observations produced by the laboratory for the patient.

520 3.32.2 Actor Roles

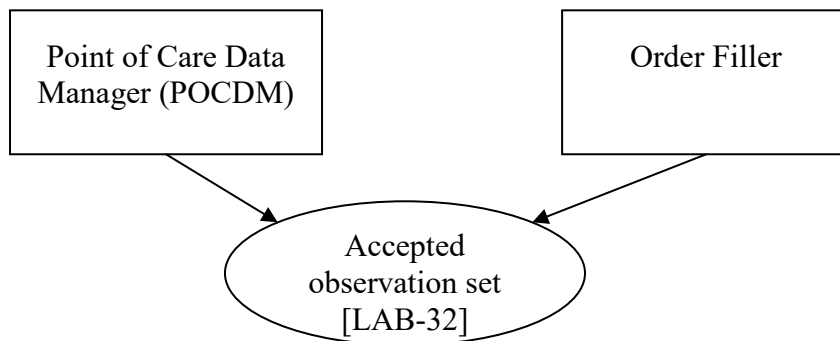

Figure 3.32.2-1: Use Case Diagram

Table 3.32.2-1: Actor Roles

Actor:	Point Of Care Data Manager (POCDM)
Role:	Forwards to the Order Filler each set of observations accepted for a patient specimen. Waits for the acknowledgement of this set of observations and stores the filler order number that it contains.
Actor:	Order Filler
Role:	Receives the set of patient observations, and according to the trigger event, either stores this set in an existing order, or generates a new order for it. In either case it will return the filler order number in the acknowledgement sent back to the POCDM.

3.32.3 Referenced Standards

525 POCT1-A: Observation Reporting Interface (ORI) defined in Appendix C of this standard. The POCT1-A standard names “*Observation Reviewer*” the IHE **POCDM**, and names “*Observation Recipient*” the IHE **Order Filler**.

HL7 v2.5: The ORI of POCT1-A relies on HL7 v2.5 messages structures ORU defined in chapter 7 of the HL7 standard.

530 All implementation rules and notes specified in the present Volume 2 of the IHE Laboratory Technical Framework fully apply to the messages of this transaction [LAB-32]. More precisely:

- Section 2.2 “HL7 profiling conventions”
- Section 2.3 “HL7 implementation notes”
- Section 3 “Common message segments for Laboratory Technical Framework”. This section provides the common description of segments MSH, MSA, NTE, ERR, PID, that are also applicable to this transaction [LAB-32].

535

3.32.4 Interaction Diagram

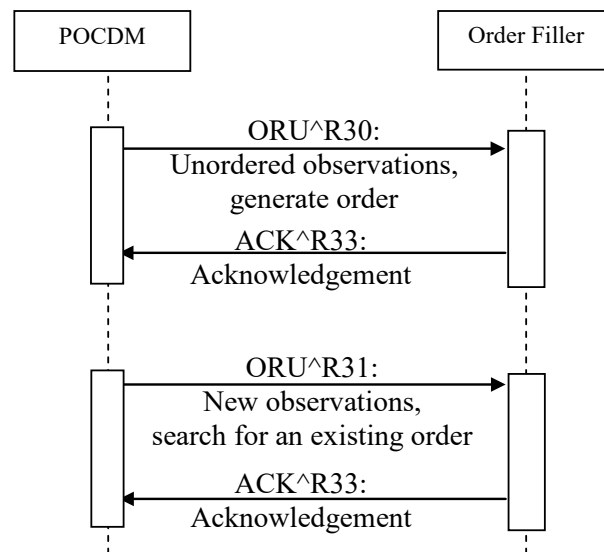

Figure 3.32.4-1: Interaction diagram for Transaction LAB-32

540 Transaction [LAB-32] offers two distinct message structures to support the various use cases described in Volume 1:

- ORU^R30 (Unordered observations) is used to instruct the Order Filler to generate a new filler order when receiving this message.
- ORU^R31 is used to instruct the Order Filler to match an existing order to store the observations into.

545

The acknowledgement to both message structures is ACK^R33. This acknowledgement is an application acknowledgement that sends back the filler order number of the order generated or matched by the Order Filler, for this set of POCT results.

550 Note 5: The trigger event ORU^R32 “preordered observations” described in POCT1-A’s ORI, is not part of the IHE LPOCT Profile.

3.32.4.1 Messages ORU^R30 and ORU^R31 and their Acknowledgement

3.32.4.1.1 Trigger Events

555 The POCDM integrates a set of point of care observations for a patient, received from a POCRG on [LAB-31]. This triggers a message of [LAB-32] that sends these observations to the Order Filler.

If the indication “existing order” is present in the set of observations, the message sent is ORU^R31, otherwise the message sent is ORU^R30.

3.32.4.1.2 Message Semantics

3.32.4.1.2.1 Common Static Definition for ORU^R30 and ORU^R31

560

Table 3.32.4.1.2.1-1: Static Definition for ORU^R30 and ORU^R31

Segment	Meaning	Usage	Card.	HL7 chapter
MSH	Message Header	R	[1..1]	2
PID	Patient Identification	R	[1..1]	3
ORC	Common Order information	R	[1..1]	4
OBR	Observation Request	R	[1..1]	4
[{NTE}]	Notes or Comments for order/Result	RE	[0..1]	4
[{	--- RESULT begin	O	[0..*]	
OBX	Observation related to OBR	R	[1..*]	7
[{NTE}]	Comment of the result	C	[0..1]	2
}]	--- RESULT end			

3.32.4.1.2.2 Usage of MSH segment

MSH-9 – Message Type, shall have its three components valued as follows:

- ORU^R30^ORU_R30 for the unordered point of care observations
 - ORU^R31^ORU_R30 for the point of care observations to match with a possibly existing order
- 565

3.32.4.1.2.3 Usage of ORC Segment

The common definition of segment ORC in PaLM TF-2x: C: 5 does not apply to this LPOCT Integration Profile: The ORU^R30 message structure instructs the recipient to generate the order, and the ORU^R31 message instructs to match an existing order, without identifying it.

570 Hence, the usage definition of ORC segment within this LPOCT Profile, below:

Table 3.32.4.1.2.3-1: ORC Segment

SEQ	LE N	DT	Usage	Card.	TBL #	ITEM#	Element name
1	2	ID	R	[1..1]	0119	00215	Order Control
2	22	EI	X	[0..0]		00216	Placer Order Number
3	22	EI	C	[0..0]		00217	Filler Order Number
4	22	EI	X	[0..0]		00218	Placer Group Number
5	2	ID	X	[0..0]	0038	00219	Order Status
7	200	TQ	X	[0..0]		00221	Quantity/Timing
8	200	EIP	X	[0..0]		00222	Parent
9	26	TS	X	[0..0]		00223	Date/Time of Transaction
10	250	XCN	X	[0..0]		00224	Entered By
11	250	XCN	X	[0..0]		00225	Verified By
17	250	CE	X	[0..0]		00231	Entering Organization
20	250	CE	X	[0..0]	0339	01310	Advanced Beneficiary Notice Code
21	250	XON	RE	[0..1]		01311	Ordering Facility Name
25	250	CWE	X	[0..0]		01473	Order Status Modifier
26	60	CWE	X	[0..0]	0552	01641	Advanced Beneficiary Notice Override Reason
27	26	TS	X	[0..0]		01642	Filler's Expected Availability Date/Time

575 **ORC-1 Order Control (ID)**, required. This field shall be valued to “NW” (new order) both in ORU^R30 and ORU^R31 message structures.

580 **ORC-3 Filler Order Number (EI)**: This LPOCT Profile applies the condition predicate specified by POCT1-A: “*The POC DM may supply an external identifier in this field that other systems can use to reference this result set. This specification places no restrictions on the format or content of this field’s value. For example, some POC DM might expose a database key in this field while others might use a combination of Device name, serial number and the timestamp of the result as the unique external identifier*”.

ORC-21 Ordering Facility Name (XON), required but may be empty (RE).

For this LPOCT Profile, this field contains the facility (ward) where this point of care observation set has been performed. These three components shall be valued:

- 585
- 1st = Organization name.
 - 7th = Identifier Type Code with the value “FI”, which means “Facility ID” as stated by HL7 table n° 0203.
 - 10th = Organization Identifier.

Example: Urology^^^^^FI^^^UR01

590 **3.32.4.1.2.4 Usage of OBR Segment**

Table 3.32.4.1.2.4-1: OBR Segment

SEQ	LE N	DT	Usage	Card.	TBL #	ITEM#	Element name
2	22	EI	X	[0..0]		00216	Placer Order Number
3	22	EI	X	[0..0]		00217	Filler Order Number
4	250	CE	R	[1..1]		00238	Universal Service Identifier
5	2	ID	X	[0..0]		00239	Priority – OBR
6	26	TS	X	[0..0]		00240	Requested Date/Time
7	26	TS	X	[0..0]		00241	Observation Date/Time
8	26	TS	X	[0..0]		00242	Observation End Date/Time
9	20	CQ	X	[0..0]		00243	Collection Volume
10	250	XCN	X	[0..0]		00244	Collector Identifier
11	1	ID	R	[1..1]	0065	00245	Specimen Action Code
12	250	CE	X	[0..0]		00246	Danger Code
13	300	ST	X	[0..0]		00247	Relevant Clinical Information
14	26	TS	X	[0..0]		00248	Specimen Received Date/Time
15	300	SPS	RE	[0..1]		00249	Specimen Source or Segment SPM
16	250	XCN	RE	[0..1]		00226	Ordering Provider
17	250	XTN	X	[0..0]		00250	Order Callback Phone Number
18	60	ST	X	[0..0]		00251	Placer Field 1
19	60	ST	X	[0..0]		00252	Placer Field 2
20	60	ST	X	[0..0]		00253	Filler Field 1
21	60	ST	X	[0..0]		00254	Filler Field 2
22	26	TS	X	[0..0]		00255	Results Rpt/Status Chng – Date/Time
23	40	MOC	X	[0..0]		00256	Charge to Practice
24	10	ID	X	[0..0]	0074	00257	Diagnostic Serv Sect ID
25	1	ID	R	[1..1]	0123	00258	Order Result Status
26	400	PRL	X	[0..0]		00259	Parent Result
27	200	TQ	X	[0..0]		00221	Quantity/Timing
28	250	XCN	X	[0..0]		00260	Result Copies To
29	200	EIP	X	[0..0]		00261	Parent
30	20	ID	X	[0..0]	0124	00262	Transportation Mode
31	250	CE	X	[0..0]		00263	Reason for Study
32	200	NDL	C	[0..1]		00264	Principal Result Interpreter
33	200	NDL	X	[0..0]		00265	Assistant Result Interpreter
34	200	NDL	RE	[0..0]		00266	Technician
37	4	NM	X	[0..0]		01028	Number of Sample Containers *
38	250	CE	X	[0..0]		01029	Transport Logistics of Collected Sample

SEQ	LE N	DT	Usage	Card.	TBL #	ITEM#	Element name
39	250	CE	X	[0..0]		01030	Collector's Comment *
40	250	CE	X	[0..0]		01031	Transport Arrangement Responsibility
41	30	ID	X	[0..0]	0224	01032	Transport Arranged
42	1	ID	X	[0..0]	0225	01033	Escort Required
43	250	CE	X	[0..0]		01034	Planned Patient Transport Comment
44	250	CE	X	[0..0]	0088	00393	Procedure Code
45	250	CE	X	[0..0]	0340	01316	Procedure Code Modifier
46	250	CE	X	[0..0]	0411	01474	Placer Supplemental Service Information
47	250	CE	X	[0..0]	0411	01475	Filler Supplemental Service Information
48	250	CWE	X	[0..0]	0476	01646	Medically Necessary Duplicate Procedure Reason.
49	2	IS	X	[0..0]	N	01647	Result Handling

OBR-4 Universal Service Identifier (CE): This field identifies either a battery (panel) or an individual test. The first sub-field (the code), and the third (the coding system) are required.

595 **OBR-11 Specimen Action Code (ID):** This required field will be valued to 'O' (Specimen obtained by service other than lab).

600 **OBR-15 Specimen source (CM):** This field is required if available within LPOCT Profile, because the messages of this profile do not embed any SPM segment, given that very little information is needed on the specimen in point of care testing. This profile applies the POCT1-A recommendations of use for this field. The following components should be valued:

- 1st component: **Specimen Source Name or Code (CWE)**, called "Specimen Type" in POCT1-A. Codes are given by table 107 in POCT1-A.
- 4th component: **Body Site (CWE)**, called "Location" in POCT1-A. Code are given by table 108 in POCT1-A.
- 605 • 7th component: **Specimen Role (CWE)**, valued to 'P' (Patient specimen).

OBR-16 Ordering Provider (XCN): This field is required if available (RE). The POCDM shall value it with the ordering physician if it knows this information.

610 **OBR-25 Order Result Status (ID):** The set of observations is considered as reviewed (i.e., technically validated) either automatically or interactively by the POCDM application (called the Observation Reviewer in POCT1-A). Therefore the status shall be valued to "F" (Final results).

OBR-32 Principal Interpreter (NDL): The field identifies who validated (reviewed) the results, and when this technical validation was performed. It shall be valued if this review has been performed interactively by a human reviewer using the POCDM; in this case only the two first components are required:

- 615
- Name (CNN):
 - First sub-subcomponent = ID number of the reviewer
 - Second sub-component = Family name
 - Third component = Given name
 - Stat Date/Time (TS): Date/Time of the review.
- 620 **OBR-34 Technician (NDL):** The field is required if available (RE). It identifies the operator who produced the set of observations on the point of care device (the actor POCRG). It also locates the point of care, room, bed, facility, and dates this production. The following components are to be valued if the information is known:
- 1st component: Name (CNN):
- 625
- First sub-subcomponent = ID number of the reviewer
 - Second sub-component = Family name
 - Third component = Given name
 - 2nd component: Stat Date/Time (TS): Date/Time of the testing.
 - 4th component: Point Of Care (IS)
- 630
- 5th component: Room (IS)
 - 6th component: Bed (IS)
 - 7th component: Facility (HD)

3.32.4.1.2.5 Static Definition for ACK^R33: Acknowledgement Message

635 This message sent by the Order Filler to the POCDM is the acknowledgement message for both ORU^R30 and ORU^R31 messages.

Table 3.32.4.1.2.5-1: static definition for ACK^R33

Segment	Meaning	Usage	Card.	HL7 chapter
MSH	Message Header	R	[1..1]	2
MSA	Message Acknowledgement	R	[1..1]	2
[{ERR}]	Error	C	[0..1]	2

MSH-9 – Message Type, shall have its three components valued “**ACK^R33^ACK**”

3.32.4.1.2.6 Usage of MSA Segment

640

Table 3.32.4.1.2.6-1: MSA - Message Acknowledgement

SEQ	LE N	DT	Usage	Card.	TBL #	ITEM#	Element name
1	2	ID	R	[1..1]	0008	00018	Acknowledgement code
2	20	ST	R	[1..1]		00010	Message Control Id
3	80	ST	R	[0..0]		00020	Text Message
5			X	[0..0]		00022	Delayed Acknowledgment Type
6	250	CE	X	[0..0]	0357	00023	Error Condition

The general specification of use of this segment is given in Volume 2x.

The particularity of use in the context of transaction [LAB-32] is as follows:

645 **MSA-3 – Text Message (ST)**, is usage R (required). This field contains the filler order number sent by the Order Filler to the POCDM.

3.32.4.1.3 Expected Actions

When receiving an ORU^R30, the Order Filler performs the following sequence of actions:

- It generates a new order to store this set of point of care observations within.
- It sends back to the POCDM the acknowledgement message ACK^R33, including the filler order number.
- Using transaction [LAB-2] of LSWF Profile, the Order Filler propagates this new order to the Order Placer, and requires a placer order number for it. The placer order number is sent back by the Order Placer to the Order Filler.
- The Order Filler stores the placer order number within the order in its database.

655 When receiving an ORU^R31, the Order Filler performs the following sequence of actions:

- It tries to match an existing order in its data base, corresponding to this set of observations. The criteria used may depend upon site-defined policies. They should include the patient, the ordering provider, the facility where the point of care tests was performed, the date-time of the observations and the ordering provider.
- If no order can be matched, the Order Filler proceeds as if it had received an ORU^R30 (see the sequence of actions above).
- If an order is matched, the Order Filler stores the results in this order, and acknowledges the order to the POCDM, sending back the filler order number in the acknowledgement.
- Using transaction [LAB-1] of LSWF Profile, the Order Filler notifies the arrival of the POCT results to the Order Placer.

665

3.32.5 Security Considerations

None.

3.33 [LAB-xx]

Left blank intentionally.

670 **3.34 [LAB-xx]**

Left blank intentionally.

3.35 [LAB-xx]

Left blank intentionally.

3.36 [LAB-xx]

675 Left blank intentionally.

3.37 [LAB-xx]

Left blank intentionally.

3.38 [LAB-xx]

Left blank intentionally.

680

3.39 Laboratory Code Set Management [LAB-51]

3.39.1 Scope

685 This transaction is used by the Code Set Master to distribute entire code sets to Code Set Consumer. A code set may contain battery, test and observation codes. This transaction is initiated on a scheduled based (e.g., weekly) or whenever the organization of the laboratory changes (e.g., because of the addition/removing of an instrument, specialties).

3.39.2 Actor Roles

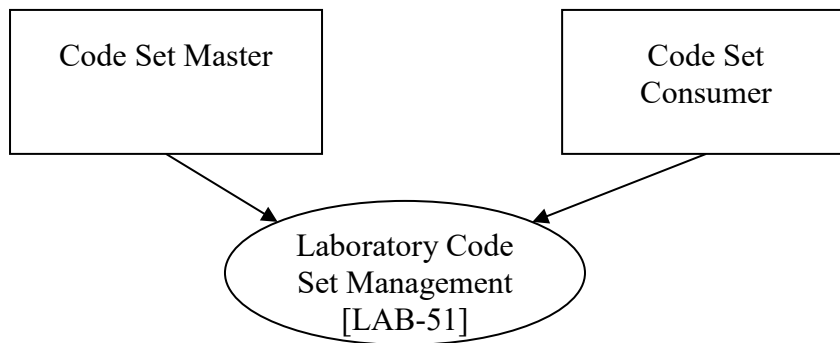

690

Figure 3.39.2-1: Use Case Diagram

Table 3.39.2-1: Actor Roles

Actor:	Code Set Master
Role:	Sends a full code set.
Actor:	Code Set Consumer
Role:	Receives a code set, and acknowledges it, with its acceptance or refusal.

3.39.3 Referenced Standards

HL7 2.5.1 Chapter 8 (Master Files)

HL7 2.5.1 Chapter 2: 2.10.3 (Batch protocol), 2.15.2 (BHS segment), 2.15.3 (BTS segment)

695 **3.39.4 Interaction Diagram**

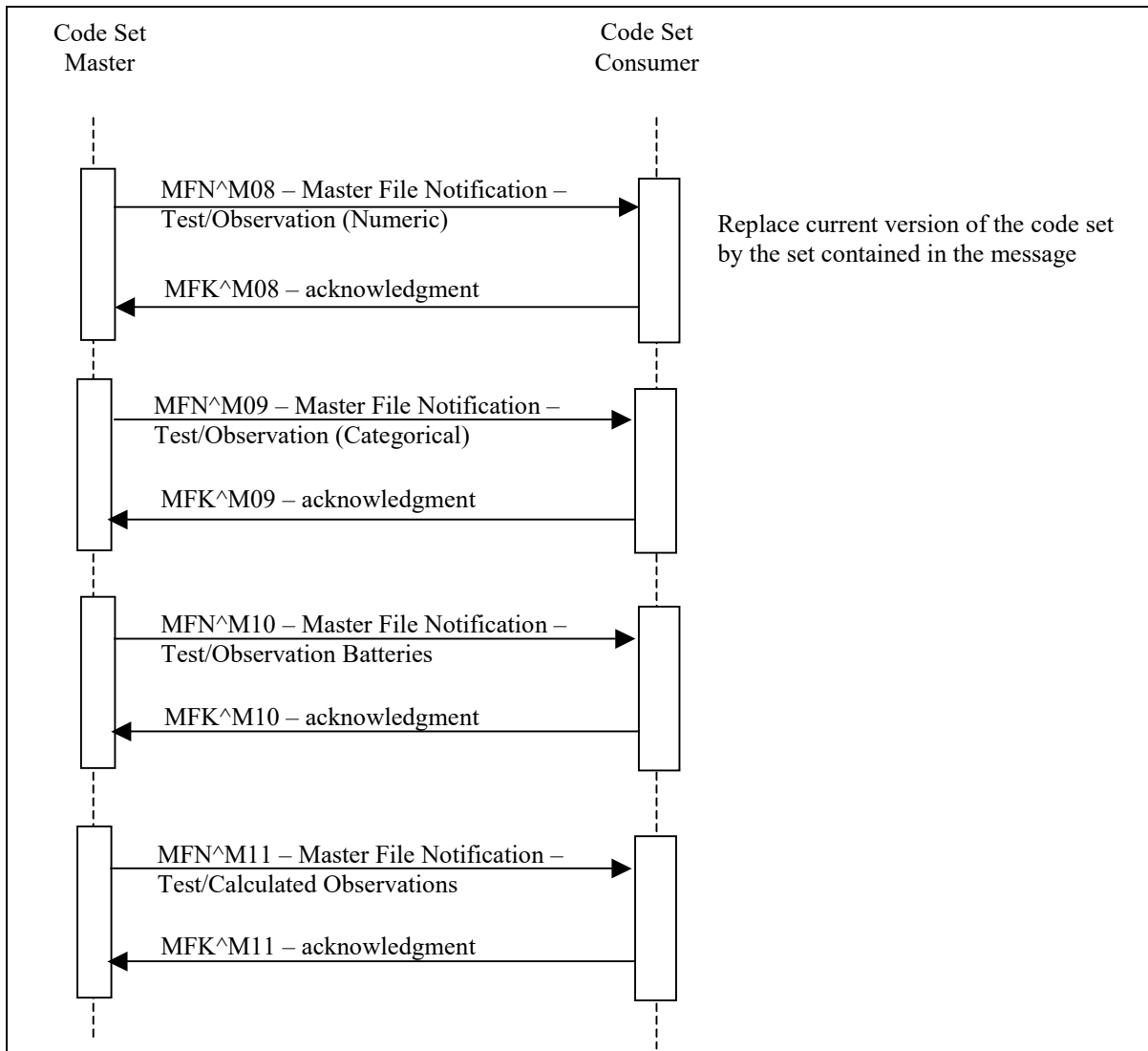

Figure 3.39.4-1: Interaction Diagram for Transaction LAB-51

The interaction diagram shows the message flow between a Code Set Master and a Code Set Consumer. Four messages are defined for this transaction:

- 700 • MFN^M08 – Master File Notification – Test/Observation (Numeric). This message is used for codes related to individual tests with numeric results. This message should not be used for battery or panel definitions. If the result of the test is a formulaic expression (a calculation) of other tests, MFN^M11 should be used instead of this message.
- 705 • MFN^M09 – Master File Notification – Test/Observation (Categorical). This message is used for codes related to individual tests with results that are NOT numeric. This message

should not be used for battery or panel definitions. If the result of the test is a formulaic expression of other tests, MFN^M11 should be used instead of this message.

- 710 • MFN^M10 – Master File Notification – Test/Observation Batteries. This message is used for codes that identify batteries or panels. This message should not be used for individual tests.
- MFN^M11 – Master File Notification – Test/Calculated Observations. This message is used for codes related to individual tests with calculated results. This message SHALL NOT be used for battery or panel definitions.

715 In order to simplify the management of observation codes (OBX-3) and battery codes (OBR-4), the MFN^M08, MFN^M09 and MFN^M11 messages SHALL be used to distribute observation codes only (OBX-3), and MFN^M10 SHALL be used to distribute battery codes (OBR-4).

The definitions of atomic tests (M08, M09) SHALL in all cases precede the definitions of batteries and calculated tests (M10, M11).

720 Without the batch option, in order to fully synchronize the code set between the Code Set Master and the Code Set Consumer, all 4 messages SHALL be sent.

The batch option enables to encapsulate the sequence of relevant messages into a single batch as shown in the figure below.

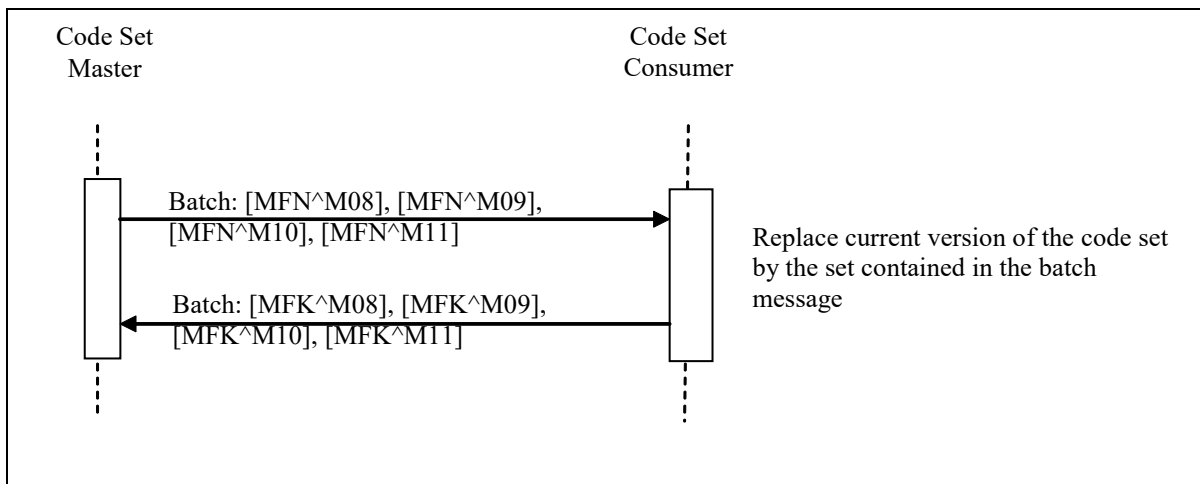

725 **Figure 3.39.4-2: Interaction Diagram for Transaction LAB-51 with the Batch Option**

The Code Set Master sends a single batch containing 1 to 4 MFN messages, and the Code Set Consumer responds with a single batch acknowledgement containing the corresponding acknowledgement MFK messages.

3.39.4.1 Messages MFN and MFK

730 3.39.4.1.1 Trigger Events

The Code Set Master has a new full revision of the laboratory code set to be distributed to the Code Set Consumer.

3.39.4.1.2 Message Semantics

Refer to HL7 Standard Chapter 8 for general semantics of the messages described in this section.

735 Refer to PaLM TF-2x: Appendix C for the description of MFI and MFE segments.

3.39.4.1.2.1 MFN^M08: Full Set of Numeric Observation Codes

Table 3.39.4.1.2.1-1: MFN^M08 static definition

Segment	Meaning	Usage	Card.	HL7
MSH	Message Header	R	[1..1]	2
MFI	Master File Identification	R	[1..1]	8
{	--- MASTER FILE ENTRY begin	R	[1..*]	8
MFE	Master File Entry	R	[1..1]	8
OM1	General Segment	R	[1..1]	8
[OM2]	Numeric Observation Segment	O	[0..1]	8
[OM4]	Observations that Require Specimens	O	[0..1]	8
}	--- MASTER FILE ENTRY end			

740 This message is used to transmit observation codes, i.e., codes sent in the OBX-3 field (Observation Identifier). Observations must have continuous values (data of type numeric, date, or time stamp).

MFI-1 Master File Identifier (CE), SHALL contain the value "OMA" (Numerical Observation Master File).

3.39.4.1.2.2 MFN^M09: Full Set of Categorical Observation Codes

745 **Table 3.39.4.1.2.2-1: MFN^M09 static definition**

Segment	Meaning	Usage	Card.	HL7
MSH	Message Header	R	[1..1]	2
MFI	Master File Identification	R	[1..1]	8
{	--- MASTER FILE ENTRY begin	R	[1..*]	8
MFE	Master File Entry	R	[1..1]	8

Segment	Meaning	Usage	Card.	HL7
OM1	General Segment	R	[1..1]	8
[--- MF_TEST_CAT_DETAIL begin	O	[0..1]	8
OM3	Categorical Service/Test/Observation Segment	R	[1..1]	8
[{OM4}]	Observations that Require Specimens	O	[0..*]	8
]	--- MF_TEST_CAT_DETAIL end			
}	--- MASTER FILE ENTRY end			

This message is used to transmit the code of observations where the value is free text or categorical and other non-numeric data types.

750 **MFI-1 Master File Identifier (CE)**, SHALL contain the value "OMB" (Categorical Observation Master File).

3.39.4.1.2.3 MFN^M10: Full Set of Battery Codes

Table 3.39.4.1.2.3-1: MFN^M10 static definition

Segment	Meaning	Usage	Card.	HL7
MSH	Message Header	R	[1..1]	2
MFI	Master File Identification	R	[1..1]	8
{	--- MASTER FILE ENTRY begin	R	[1..*]	8
MFE	Master File Entry	R	[1..1]	8
OM1	General Segment	R	[1..1]	8
[--- MF_TEST_BATT_DETAIL begin	RE	[0..1]	8
OM5	Observation Batteries	R	[1..1]	8
[{OM4}]	Observations that Require Specimens	O	[0..*]	8
]	--- MF_TEST_BATT_DETAIL end			
}	--- MASTER FILE ENTRY end			

755 This message is used to transmit battery codes, i.e., codes sent in the OBR-4 field (Universal Service Identifier).

MFI-1 Master File Identifier (CE), SHALL contain the value "OMC" (Observation Batteries Master File).

3.39.4.1.2.4 MFN^M11: Full Set of Calculated Observation Codes

Table 3.39.4.1.2.4-1: MFN^M11 static definition

Segment	Meaning	Usage	Card.	HL7
MSH	Message Header	R	[1..1]	2
MFI	Master File Identification	R	[1..1]	8
{	--- MASTER FILE ENTRY begin	R	[1..*]	8
MFE	Master File Entry	R	[1..1]	8
OM1	General Segment	R	[1..1]	8
[
OM6	Observation calculated from other observations	O	[0..1]	8
OM2	Numeric Observation Segment	O	[0..1]	8
]				
}	--- MASTER FILE ENTRY end			

760

This message is used to transmit the code of observations where the value is derived from one or more quantities or direct observations.

MFI-1 Master File Identifier (CE), SHALL contain the value "OMD" (Calculated Observation Master File).

765 3.39.4.1.2.5 MFK: Acknowledgement Message

The Master File Application Acknowledgment message is defined in HL7 2.5 Chapter 8.

The structure of the acknowledgement messages is the same for all acknowledgements:

Table 3.39.4.1.2.5-1: MFK^M08, MFK^M09, MFK^M10, MFK^M11 Static Definition

Segment	Meaning	Usage	Card.	HL7
MSH	Message Header	R	[1..1]	2
MSA	Acknowledgment	R	[1..1]	2
[{ERR}]	Error	C	[1..1]	2
MFI	Master File Identification	R	[1..1]	8
{	--- MASTER FILE ENTRY begin	C	[0..*]	8
MFA	Master File ACK Segment	R	[1..1]	8
}	--- MASTER FILE ENTRY end			

770

MSH, MSA and ERR segments are described in PaLM TF-2x: Appendix C. The ERR segment SHALL be used in case of negative acknowledgement, i.e., when the receiving application sends an error on one Master File entry.

775

The MASTER FILE ENTRY segment group is conditional upon the presence of errors (see the description of field MFI-6). The segment group SHALL only be populated with MFA Segment for those master file entries that could NOT be accepted. If the entire batch can be accepted by the receiver then the acknowledgement message shall not contain any MFA segments.

3.39.4.1.2.6 OM1 – General Segment

Table 3.39.4.1.2.6-1: OM1 – General Segment

SEQ	LEN	DT	Usage	Card.	TBL#	ITEM#	Element name
1	4	NM	R	[1..1]		00586	Sequence Number - Test/Observation Master File
2	250	CE	R	[1..1]		00587	Producer's Service/Test/Observation ID
3	12	ID	O	[0..*]	0125	00588	Permitted Data Types
4	1	ID	R	[1..1]	0136	00589	Specimen Required
5	250	CE	R	[1..1]		00590	Producer ID
7	250	CE	O	[0..*]		00592	Other Service/Test/Observation IDs for the Observation
8	200	ST	R	[1..*]		00593	Other Names
12	1	ID	O	[0..1]	0136	00597	Orderability
18	1	IS	R	[1..1]	0174	00603	Nature of Service/Test/Observation
19	250	CE	RE	[0..1]	99999	00604	Report Subheader
20	20	ST	RE	[0..1]		00605	Report Display order
30	250	CWE	O	[0..1]	0177	00615	Confidentiality Code
31	250	CE	O	[0...*]	9999	00616	Observations Required to Interpret the Observation

780

OM1-1 Sequence Number – Test/Observation Master File (NM), required, shall contain a sequence number from 1 to n (number of records).

OM1-2 MFN Producer's Service/Test/Observation ID (CE) is required. Only the first three sub-fields (Identifier, Text and Name of Coding System) are required. The last 3 components of the CE data type shall not be valued.

(MFN^M08 and MFN^M10 and MFN^M11 messages)

785

OM1-3 Permitted Data Types (ID), optional, should contain numerical, date or time stamp data types, in MFN^M08 and MFN^M10 and MFN^M11 messages.

OM1-3 Permitted Data Types (ID), optional, should contain data types other than numerical, date or time stamp in MFN^M09 message.

790 **OM1-4 Specimen Required (ID)**, required, contain the value Y if one or more specimen are required to obtain this observation, and N if a specimen is not required.

OM1-5 Producer ID (CE), required, uniquely identifies the service producing the observation. Only the first three sub-fields (Identifier, Text and Name of Coding System) are required.

795 **OM1-7 Other Service/Test/Observation IDs for the Observation (CE)** is optional and repeating. It can be used to send mapped/translated codes to the destination system. This field can be used to convey the mapping of local codes to reference code sets such as LOINC or SNOMED CT.

OM1-8 Other Names (ST), required, contains aliases or synonyms for the name in the context of the Order Placer. By default, this field can contain the same value as OM1-2 (2nd sub-field).

800 **OM1-12 Orderability (ID)**, optional, indicates whether or not a service/test/observation is an orderable code. For example, blood differential count is usually an orderable "test," MCV, contained within the differential count, is usually not independently orderable.

HL7 Table 0136 – Yes/No Indicator Values

Value	Description
Y	The service/test/observation is an orderable code
N	The service/test/observation is not orderable

805 **OM1-18 Nature of Service/Test/Observation (IS)**, required, contains the value A (atomic observation) in MFN^M08 and MFN^M09 messages.

OM1-18 Nature of Service/Test/Observation (IS), required, contains the value P (battery consisting of one or many independent atomic observations), F (functional procedure) and S (superset of batteries or procedure ordered under a single code unit) in MFN^M10 message.

810 **OM1-18 Nature of Service/Test/Observation (IS)**, required, contains the value C (single observation calculated via a rule or formula from other independent observations) in MFN^M11 message.

OM1-19 Report Subheader (CE), required if known, contains an optional string that defines the preferred header under which this observation should be listed on a standard display.

815 **OM1-20 Report Display Order (ST)**, required if known, contains an optional string that defines the absolute sort order in which this observation is presented in a standard report or display that contains the many observations.

820 **OM1-30 Confidentiality Code (CWE)**, optional, contains the degree to which special confidentiality protection should be applied to the observation. For example, a tighter control may be applied to an HIV test than to a CBC. This field can especially be useful if all observations for the OM1 record can be treated in the same manner.

HL7 Table 0177 – Confidentiality Code (Subset)

Value	Description
V	Very restricted
R	Restricted
U	Usual control

OM1-31 Observations Required to Interpret the Observation (CE), optional.

825 This field contains the list of supporting observations (e.g., patient temperature) needed by the laboratory to perform the ordered test.

Each of these supporting observations appears as a coded test that must have been sent ahead of the current test, in the same catalog, published through transaction [LAB-51].

The observations specified here should be sent to the diagnostic service as OBX segments along with the order (OBR) segment in [LAB-1] messages.

830 **3.39.4.1.2.7 OM2 – Numeric Observation Segment**

Table 3.39.4.1.2.7-1: OM2 – Numeric Observation Segment

SEQ	LEN	DT	Usage	Card.	TBL#	ITEM#	Element name
2	250	CE	R	[1..1]		00627	Units of Measure
3	10	NM	RE	[0..*]		00628	Range of Decimal Precision
6	250	RFR	O	[0..*]		00631	Reference (Normal) Range For Ordinal And Continuous Observations

OM2-2 Units of Measure (CE), required. Used only if the test contained in OM1 has numeric results. Contains the customary units of measure for the test.

835 **OM2-3 Range of Decimal Precision (NM)**, required if known. Used only if the test contained in OM1 has numeric results. Specifies the total length in characters of the field needed to display the observation, and the number of digits displayed to the right of the decimal point. This is coded as a single number in the format <length>.<decimal-digits>. For example, a value of 6.2 implies 6 characters total (including the sign and decimal point) with 2 digits after the decimal point. For integer values, the period and <decimal-digits> portion may be omitted (that is, 5.0 and 5 are equivalent). More than one such mask may be transmitted (separated by repeat delimiters) when it is necessary to define possible multiple display formats.

840

OM2-6 Reference (Normal) Range for Ordinal and Continuous Observations, Optional.

845 This field contains the reference (normal) ranges for "numeric" observations/tests with a nature code of A or C (see OM1-18 - Nature of Service/Test/Observation). The use of this field is discouraged (but not forbidden) by IHE. This field can identify different reference (normal)

850 ranges for different categories of patients according to age, sex, race, and other patient conditions. Reference (normal) ranges however also depend on the Analyzer being used, a factor which isn't included in this field. Without having knowledge of the Analyzer generic statements about reference ranges may be clinically misleading and dangerous.

3.39.4.1.2.8 OM3 Categorical Service/Test/Observation Segment

The OM3 segment is used as part of the MFN^M09 message to convey information related to non-numeric tests, that is tests expecting a coded or free text result.

855 This segment description is taken from version 2.7 of the HL7 standard, since version 2.5 had a bug in the segment description.

Fields 2 to 6 are not constrained in length, as stated in the 2.7 HL7 standard.

Table 3.39.4.1.2.8-1: OM3 – Categorical Service/Test/Observation

SEQ	LEN	DT	Usage	Card.	TBL#	ITEM#	Element name
1	4	NM	O	[0..1]		00586	Sequence Number - Test/Observation Master File
2		CWE	O	[0..1]		00636	Preferred Coding System
3		CWE	O	[0..*]		00637	Valid Coded Answers
4		CWE	O	[0..*]		00638	Normal Text/Codes for Categorical Observations
5		CWE	O	[0..*]		00639	Abnormal Text/Codes for Categorical Observations
6		CWE	O	[0..*]		00640	Critical Text/Codes for Categorical Observations
7	2..3	ID	O	[0..1]	0125	00570	Value Type

OM3-1 Sequence Number - Test/Observation Master File, optional.

860 HL7 2.7 definition:

If used, this field contains the same value as the sequence number of the associated OM1 segment.

OM3-2 Preferred Coding System, optional.

865 This field is used in case there is one coding system, from which the valid values for the observations will be taken. Record the preferred coding system for this observation (e.g., ICD-10, SNOMED CT ...).

OM3-3 Valid Coded Answers, optional.

This field is used in case the list of coded answers is easily enumerated. It contains the list of valid coded answers. Multiple values in this field shall be separated with a repeat delimiter.

870 OM3-4 Normal Text/Codes for Categorical Observations, optional.

This field is used to specify the list of answers that are considered normal for that test.

The format of this field is:

- The first component is a code taken from a standard code source list.
- The second component is the text associated with the code (i.e., the meaning of the code).
- 875 • The third component is the identification of the coding system. When only a text description of a possible answer is available, it is recorded as ^<text>.

Multiple values in this field shall be separated with a repeat delimiter.

OM3-5 Abnormal Text/Codes for Categorical Observations, optional.

This field is used to specify the list of answers that are considered abnormal for that test.

880 Same structure as OM3-4.

OM3-6 Critical Text/Codes for Categorical Observations, optional.

This field is used to specify the list of answers that are considered critical for that test.

Same structure as OM3-4.

OM3-7 Value Type, optional.

885 If used, this field contains the allowed data type for a single categorical observation (code A in OM1-18 - Nature of Observation).

3.39.4.1.2.9 OM4 Segment: Observations that Require Specimens

890 The OM4 segment is used to convey information related to the (collection of) specimen required for the test/battery. This information can be used by Order Placers (e.g., at the ward) to collect the specimen.

Table 3.39.4.1.2.9-1: OM4 – Observations that Require Specimens

SEQ	LEN	DT	Usage	Card.	TBL#	ITEM#	Element name
3	60	TX	R	[1..1]		00643	Container Description
4	20	NM	O	[0..1]		00644	Container Volume
6	250	CE	O	[0..1]		00646	Specimen
10	20	CQ	O	[0..1]		00650	Normal Collection Volume
11	20	CQ	O	[0..1]		00651	Minimal Collection Volume

895 **OM4-3 Container Description (TX)**, required. Used only if OM1-4 contains “Y”; contains a textual description of the type of container used for collection of the sample, e.g., “Red capped tube #2”.

OM4-4 Container Volume (NM), optional, indicates the capacity of the container

OM4-6 Specimen (CE), optional. See SPM-4 for additional information. The actor shall use one and the same vocabulary table for OM4-6 and SPM-4 if the Code Set Master is also an Order Filler Actor.

900 **OM4-10 Normal Collection Volume (CQ)**, optional, contains the normal specimen volume required by the lab. This is the amount used by the normal methods and provides a sufficient amount to repeat the procedure at least once if needed. The default unit is milliliters (ml).

905 **OM4-11 Minimal Collection Volume (CQ)**, optional, contains the volume needed by the most specimen sparing method (e.g., using micro techniques). The minimum amount allows for only one determination. The default unit is milliliters (ml).

3.39.4.1.2.10 OM5 – Observation Batteries

Table 3.39.4.1.2.10-1: OM5 – Observation Batteries

SEQ	LEN	DT	Usage	Card.	TBL#	ITEM#	Element name
2	250	CE	R	[1..*]		00655	Test/Observations Included within an Ordered Test Battery

OM5-2 Test/Observations Included within an Ordered Test Battery, required, contains the codes and names of all tests/observations included within a single battery.

910 If the OM1 segment defined serum electrolytes, this field might look like the following:
84132^potassium^AS4~84295^sodium^AS4~82435^chloride^AS4~82374^HCO3^^AS4

3.39.4.1.2.11 MFA - Master File Acknowledgement Segment

Table 3.39.4.1.2.11-1: MFA – Master File Acknowledgment Segment

SEQ	LEN	DT	Usage	Card.	TBL#	ITEM#	Element name
1	3	ID	R	[1..1]	0180	00664	Record-Level Event Code
2	20	ST	R	[1..1]		00665	MFN Control ID
3	26	TS	O	[0..1]		00668	Event Completion Date/Time
4	250	CE	R	[1..1]	0181	00669	MFN Record Level Error Return
5	250	CE	R	[1..1]		01308	Primary Key Value - MFA
6	3	ID	R	[1..1]	0355	01320	Primary Key Value Type - MFA

915 **MFA-1 Record-Level Event Code (ID)**, required, shall contain the value MAD (add record to master file).

MFA-2 MFN Control ID (ST) is required and contains an identifier that uniquely identifies the change to the record.

920 **MFA-4 MFN Record Level Error Return (CE)**, required, contains the status of the requested update. The actors of IHE Laboratory Technical Framework should support the following values:

Table 3.39.4.1.2.11-2: MFN record-level error return

Value	Description
S	Successful posting of the record defined by the MFE segment
U	Unsuccessful posting of the record defined by the MFE segment

MFA-5 Primary Key Value – MFA, required, uniquely identifies a record of the code set. It contains the same value as MFE-4.

925 **MFA-6 Primary Key Value Type - MFA (ID)**, required, contains the value CE (coded element).

3.39.4.1.2.12 Batch Message Static Definitions

Table 3.39.4.1.2.12-1: Batch Message Static Definition

Segment	Meaning	Usage	Card	HL7
BHS	Batch Header Segment	R	[1..1]	2
{				
[--- Start MFN^M08 message (Test/Observation Numeric)	O	[0..1]	8
MSH	Message Header	R	[1..1]	2
MFI	Master File Identification	R	[1..1]	8
{	--- MASTER FILE ENTRY begin	R	[1..*]	8
MFE	Master File Entry	R	[1..1]	8
OM1	General Segment	R	[1..1]	8
[OM2]	Numeric Observation Segment	O	[0..1]	8
[OM4]	Observations that Require Specimens	O	[0..1]	8
}	--- MASTER FILE ENTRY end			
]	--- End MFN^M08 message			
[--- Start MFN^M09 message (Test/Observation Categorical)	O	[0..1]	8
MSH	Message Header	R	[1..1]	2
MFI	Master File Identification	R	[1..1]	8
{	--- MASTER FILE ENTRY begin	R	[1..*]	8
MFE	Master File Entry	R	[1..1]	8
OM1	General Segment	R	[1..1]	8
[--- MF_TEST_CAT_DETAIL begin	O	[0..1]	8
OM3	Categorical Service/Test/Observation Segment	R	[1..1]	8
[{OM4}]	Observations that Require Specimens	O	[0..*]	8
]	--- MF_TEST_CAT_DETAIL end			

Segment	Meaning	Usage	Card	HL7
}	--- MASTER FILE ENTRY end			
]	--- End MFN^M09 message			
[--- Start MFN^M10 message (Test/Observation Batteries)	O	[0..1]	8
MSH	Message Header	R	[1..1]	2
MFI	Master File Identification	R	[1..1]	8
{	--- MASTER FILE ENTRY begin	R	[1..*]	8
MFE	Master File Entry	R	[1..1]	8
OM1	General Segment	R	[1..1]	8
[--- MF_TEST_BATT_DETAIL begin	RE	[0..1]	8
OM5	Observation Batteries	R	[0..1]	8
[{OM4}]	Observations that Require Specimens	O	[0..1]	8
]	--- MF_TEST_BATT_DETAIL end			
}	--- MASTER FILE ENTRY end			
]	--- End MFN^M10 message			
[Start MFN^M11 message (Test/Observation Numeric)	O	[0..1]	8
MSH	Message Header	R	[1..1]	2
MFI	Master File Identification	R	[1..1]	8
{	--- MASTER FILE ENTRY begin	R	[1..*]	8
MFE	Master File Entry	R	[1..1]	8
OM1	General Segment	R	[1..1]	8
[
OM6	Observation calculated from other observations		[0..1]	8
OM2	Numeric Observation Segment		[0..1]	8
]				
}	--- MASTER FILE ENTRY end			
]				
}				
BTS	Batch Trailer Segment	R	[1..1]	2

3.39.4.1.2.13 Batch Message Acknowledgement

930

Table 3.39.4.1.2.13-1: Batch Message Acknowledgment Static Definition

Segment	Meaning	Usage	Card	HL7
BHS	Batch Header Segment	R	[1..1]	2
{				

IHE Pathology & Laboratory Medicine Technical Framework, Vol. 2c (PaLM TF-2c):
Transactions

Segment	Meaning	Usage	Card	HL7
[--- Start MFK^M08 acknowledgment	O	[0..1]	2
MSH	Message Header	R	[1..1]	2
MSA	Acknowledgment	R	[1..1]	2
[{ERR}]	Error	C	[1..1]	2
MFI	Master File Identification	R	[1..1]	8
{	--- MASTER FILE ENTRY begin	R	[1..*]	8
MFA	Master File ACK segment	R	[1..1]	8
}	--- MASTER FILE ENTRY end			
]	--- End MFK^M08 message			
[--- Start MFK^M09 acknowledgment	O	[0..1]	2
MSH	Message Header	R	[1..1]	2
MSA	Acknowledgment	R	[1..1]	2
[{ERR}]	Error	C	[1..1]	2
MFI	Master File Identification	R	[1..1]	8
{	--- MASTER FILE ENTRY begin	R	[1..*]	8
MFA	Master File ACK segment	R	[1..1]	8
}	--- MASTER FILE ENTRY end			
]	--- End MFK^M09 message			
[--- Start MFK^M10 acknowledgment	O	[0..1]	2
MSH	Message Header	R	[1..1]	2
MSA	Acknowledgment	R	[1..1]	2
[{ERR}]	Error	C	[1..1]	2
MFI	Master File Identification	R	[1..1]	8
{	--- MASTER FILE ENTRY begin	R	[1..*]	8
MFA	Master File ACK segment	R	[1..1]	8
}	--- MASTER FILE ENTRY end			
]	--- End MFK^M10 message			
[--- Start MFK^M11 acknowledgment	O	[0..1]	2
MSH	Message Header	R	[1..1]	2
MSA	Acknowledgment	R	[1..1]	2
[{ERR}]	Error	C	[1..1]	2
MFI	Master File Identification	R	[1..1]	8
{	--- MASTER FILE ENTRY begin	R	[1..*]	8
MFA	Master File ACK segment	R	[1..1]	8
}	--- MASTER FILE ENTRY end			

Segment	Meaning	Usage	Card	HL7
]	--- End MFK^M11 message			
}				
BTS	Batch Trailer Segment	R	[1..1]	2

3.39.4.1.2.14 BHS – Batch Header Segment

Table 3.39.4.1.2.14-1: Batch Header Segment Static Definition

SEQ	LEN	DT	USAGE	Card.	TBL#	ITEM#	Element name
1	1	ST	R	[1..1]		00081	Batch Field Separator
2	3	ST	R	[1..1]		00082	Batch Encoding Characters
3	227	HD	R	[1..1]		00083	Batch Sending Application
4	227	HD	R	[1..1]		00084	Batch Sending Facility
5	227	HD	R	[1..1]		00085	Batch Receiving Application
6	227	HD	R	[1..1]		00086	Batch Receiving Facility
7	26	TS	R	[1..1]		00087	Batch Creation Date/Time
8	40	ST	X	[0..0]		00088	Batch Security
9	20	ST				00089	Batch Name/ID/Type
10	80	ST				00090	Batch Comment
11	20	ST	RE	[0..1]		00091	Batch Control ID
12	20	ST	RE	[0..1]		00092	Reference Batch Control ID

935 **BHS-1 Batch Field Separator**, required: The IHE Laboratory Technical Framework requires that applications support HL7-recommended value that is | (ASCII 124).

BHS-2 Batch Encoding Characters, required: This field contains the four characters in the following order: the component separator, repetition separator, escape character, and subcomponent separator. The IHE Laboratory Technical Framework requires that applications support HL7-recommended values ^~\& (ASCII 94, 126, 92, and 38, respectively).

940 **BHS-4 Batch Sending Facility (HD)**, required:

Components: <Namespace ID (IS)> ^ <Universal ID (ST)> ^ <Universal ID Type (ID)>

The IHE Laboratory Technical Framework requires that this field be populated with:

First component (required): Namespace ID. The name of the organizational entity responsible for the sending application.

945 Second component (optional): The URI (OID) of the organizational entity responsible for the sending application.

Third component (optional): The type of identification URI provided in the second component of this field. The codification of these three components is entirely site-defined. It may be detailed in the national extensions of this framework.

950 **BHS-6 Batch Receiving Facility (HD)**, required:

Components: <Namespace ID (IS)> ^ <Universal ID (ST)> ^ <Universal ID Type (ID)>

This field SHALL be populated with:

First component (required): Namespace ID. The name of the organizational entity responsible for the receiving application.

955 Second component (optional): The URI (e.g., OID) of the organizational entity responsible for the receiving application.

Third component (optional): The type of identification URI provided in the second component of this field. The codification of these three components is entirely site-defined. It may be detailed in the national extensions of this framework.

960 **BHS-11 Batch Control Id (ST)**, required in the initiating message: This field is used to uniquely identify a particular batch. It must be echoed back in BHS-12 – reference batch control ID of the responding batch of HL-7 MFK messages. The combination of this identifier and the name of the batch sending application (BHS-3) should be unique across the Healthcare enterprise.

965 **BHS-12 Reference Batch Control (ID)**, required in the responding message: This field contains the value of the Batch Control Id (BHS-11) of the initiating batch of HL-7 MFN messages.

3.39.4.1.2.15 BTS – Batch Trailer Segment

Table 3.39.4.1.2.15-1: Batch Trailer Segment Static Definition

SEQ	LEN	DT	USAGE	Card.	TBL#	ITEM#	Element name
1	10	ST	O	[0..1]		00093	Batch Message Count
2	80	ST	O	[0..1]		00090	Batch Comment
3	100	NM	O	[0..*]		00095	Batch Totals

3.39.4.1.3 Expected Actions

970 The Code Set Consumer must replace its corresponding code set by the received code set. Codes which have been removed from the code set are not to be used by the receiving system any more from the effective date/time given in the message. Codes which have been removed should not be deleted but be flagged as disabled/invalid for backward compatibility reasons. New added codes are usable from the effective date/time given in the message.

3.39.5 Security Considerations

975 None.

3.40 [LAB-xx]

Left blank intentionally.

3.41 [LAB-xx]

Left blank intentionally.

980 **3.42 [LAB-xx]**

Left blank intentionally.

3.43 [LAB-xx]

Left blank intentionally.

985 **3.44 Label Delivery Request [LAB-61]**

3.44.1 Scope

This transaction is used by the Label Information Provider to send label and container delivery instructions to the Label Broker, to enable the collection of specimens related to an order or to an order group.

990 **3.44.2 Actor Roles**

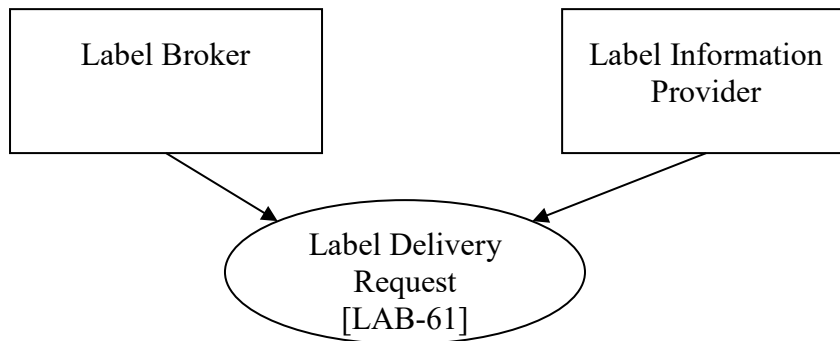

Figure 3.44.2-1: Use Case Diagram

Table 3.44.2-1: Actor Roles

Actor:	Label Information Provider
Role:	Sends the labeling and container delivery instructions
Actor:	Label Broker
Role:	Receives labeling instructions to issue the specimen container labels and stick them on the appropriate containers.

3.44.3 Referenced Standards

995 HL7 v2.5.1, Chapter 4

3.44.4 Interaction Diagram

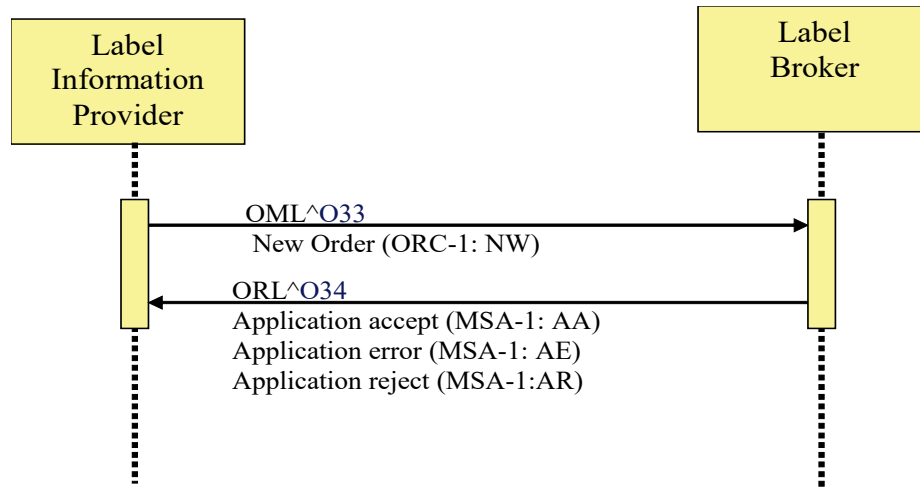

Figure 3.44.4-1: Interaction diagram for Transaction LAB-61

3.44.4.1 Message Pair OML^O33 and ORL^O34

1000 3.44.4.1.1 Trigger Events

A new order or order group of laboratory tests needs specimens to be collected from the subject. The instructions for delivery and labeling of the needed specimens have been computed by the Label Information Provider. This triggers the notification of these instructions to the Label Broker, using an OML^O33 message.

1005 3.44.4.1.2 Message Semantics

The OML message with Order Control Code ‘NW’ received from the Label Information Provider, contains the specimen container labeling instructions for the Label Broker.

3.44.4.1.2.1 Static Definition of OML^O33

Table 3.44.4.1.2.1-1: OML^O33

Segment	Meaning	Usage	Card.	HL7 chapter
MSH	Message Header	R	[1..1]	2
[--- PATIENT begin	R	[1..1]	
PID	Patient Identification	R	[1..1]	3
[PV1]	Patient Visit	RE	[0..1]	3
]	--- PATIENT end			
{	--- SPECIMEN begin	R	[1..*]	
SPM	Specimen	R	[1..1]	7
[{SAC}]	Specimen Container	O	[0..*]	

Segment	Meaning	Usage	Card.	HL7 chapter
{	--- ORDER begin	R	[1..*]	
ORC	Common Order (for one battery)	R	[1..1]	4
[{TQ1}]	Timing Quantity	RE	[0..1]	4
[--- OBSERVATION REQUEST begin	O	[0..1]	
OBR	Observation Request	R	[1..1]	4
[TCD]	Test Code Details	O	[0..1]	13
[{O BX}]	Observation Result	O	[0..*]	7
]	--- OBSERVATION REQUEST end			
}	--- ORDER end			
}	--- SPECIMEN end			

1010

MSH-9 - Message Type (MSG) shall have its three components respectively valued to "OML", "O33" and "OML_O33".

1015 This message carries the specimen container labeling instructions in the SPECIMEN segment group: The SPM segment contains the specimen ID (SPM-2), specimen type (SPM-4), specimen source site (SPM-8), specimen collection amount (SPM-12), container type (SPM-27)...
Optionally, the SAC segment may be used to deliver additional information on the physical container to be selected by the Label Broker.

Usage of the SAC segment:

1020 In some cases, depending upon the laboratory organizational policy, more than one tube or label may be needed for the same SPECIMEN_ID. Each additional label/tube, other than the first one, is requested through a SAC segment appended below the SPM segment. The Laboratory Information Provider SHALL provide, in the OML_O33 message, immediately after the related SPM segment, as many SAC segment as there are additional labels requested. Refer to PaLM TF-2.x:C.8 for details on usage of the SAC segment.

1025 3.44.4.1.2.2 Static Definition of ORL^O34

Table 3.44.4.1.2.2-1: ORL^O34

Segment	Meaning	Usage	Card.	HL7 chapter
MSH	Message header	R	[1..1]	2
MSA	Message Acknowledgement	R	[1..1]	2
[{ERR}]	Error	C	[0..*]	2
[--- RESPONSE begin	O	[0..1]	
[PID]	Patient Identification	O	[0..1]	3
{	--- SPECIMEN begin	O	[0..*]	
SPM	Specimen	R	[1..1]	7

Segment	Meaning	Usage	Card.	HL7 chapter
{SAC}	Specimen Container	O	[0..*]	13
{	--- ORDER begin	O	[0..*]	
ORC	Common Order	R	[1..1]	4
{TQ1 }	Timing/Quantity	RE	[0..1]	4
[OBR]	Observation Request	R	[1..1]	4
}]	--- ORDER end			
}	--- SPECIMEN end			
]	--- RESPONSE end			

MSH-9 - Message Type (MSG) shall have its three components respectively valued to "ORL", "O34" and "ORL_O34".

1030 Condition predicate for use of the ERR segment:

The ERR segment SHALL be used whenever the Label Broker does not accept the labeling instruction (MSA-1 = AE or AR).

3.44.4.1.2.3 OBR Segment

Table 3.44.4.1.2.3-1: OBR Segment

SEQ	LEN	DT	Usage	Card.	TBL #	ITEM#	Element name
1	4	SI	O	[0..1]		00237	Set ID – OBR
2	22	EI	R	[1..1]		00216	Placer Order Number
3	22	EI	RE	[0..1]		00217	Filler Order Number
4	250	CE	R	[1..1]		00238	Universal Service Identifier
5	2	ID	X	[0..0]		00239	Priority – OBR
6	26	TS	X	[0..0]		00240	Requested Date/Time
7	26	TS	X	[0..0]		00241	Observation Date/Time #
8	26	TS	X	[0..0]		00242	Observation End Date/Time #
9	20	CQ	X	[0..0]		00243	Collection Volume *
10	250	XC N	O	[0..*]		00244	Collector Identifier *
11	1	ID	RE	[0..1]	0065	00245	Specimen Action Code *
12	250	CE	X	[0..0]		00246	Danger Code
13	300	ST	X	[0..0]		00247	Relevant Clinical Information
14	26	TS	X	[0..0]		00248	Specimen Received Date/Time *
15	300	SPS	X	[0..0]		00249	Specimen Source
16	250	XC	R	[1..1]		00226	Ordering Provider

IHE Pathology & Laboratory Medicine Technical Framework, Vol. 2c (PaLM TF-2c):
Transactions

SEQ	LEN	DT	Usage	Card.	TBL #	ITEM#	Element name
		N					
17	250	XT N	RE	[0..2]		00250	Order Callback Phone Number
18	60	ST	X	[0..0]		00251	Placer Field 1
19	60	ST	X	[0..0]		00252	Placer Field 2
20	60	ST	X	[0..0]		00253	Filler Field 1 +
21	60	ST	X	[0..0]		00254	Filler Field 2 +
22	26	TS	X	[0..0]		00255	Results Rpt/Status Chng - Date/Time +
23	40	MO C	X	[0..0]		00256	Charge to Practice +
24	10	ID	C	[0..1]	0074	00257	Diagnostic Serv Sect ID
25	1	ID	X	[0..0]	0123	00258	Result Status +
26	400	PRL	X	[0..0]		00259	Parent Result +
27	200	TQ	X	[0..0]		00221	Quantity/Timing
28	250	XC N	O	[0..*]		00260	Result Copies To
29	200	EIP	X	[0..0]		00261	Parent
30	20	ID	X	[0..0]	0124	00262	Transportation Mode
31	250	CE	O	[0..1]		00263	Reason for Study
32	200	ND L	O	[0..1]		00264	Principal Result Interpreter +
33	200	ND L	O	[0..1]		00265	Assistant Result Interpreter +
34	200	ND L	O	[0..1]		00266	Technician +
35	200	ND L	O	[0..1]		00267	Transcriptionist +
36	26	TS	O	[0..1]		00268	Scheduled Date/Time +
37	4	NM	O	[0..1]		01028	Number of Sample Containers *
38	250	CE	O	[0..1]		01029	Transport Logistics of Collected Sample *
39	250	CE	O	[0..1]		01030	Collector's Comment *
40	250	CE	X	[0..0]		01031	Transport Arrangement Responsibility
41	30	ID	X	[0..0]	0224	01032	Transport Arranged
42	1	ID	X	[0..0]	0225	01033	Escort Required
43	250	CE	X	[0..0]		01034	Planned Patient Transport Comment
44	250	CE	O	[0..1]	0088	00393	Procedure Code
45	250	CW E	O	[0..1]	0340	01316	Procedure Code Modifier
46	250	CE	O	[0..1]	0411	01474	Placer Supplemental Service Information
47	250	CE	O	[0..1]	0411	01475	Filler Supplemental Service Information

SEQ	LEN	DT	Usage	Card.	TBL #	ITEM#	Element name
48	250	CW E	X	[0..0]	0476	01646	Medically Necessary Duplicate Procedure Reason.
49	2	IS	O	[0..1]	0507	01647	Result Handling

1035 **3.44.4.1.3 Expected Actions**

The Label Broker SHALL reply with an ORL^O34 message with either “Accept” (MSA-1 = AA) or “Reject” (MSA-1 = AR) or “Error” (MSA-1 = AE).

The Label Broker then delivers the requested labels and containers.

3.44.5 Security Considerations

1040 None.

3.45 Query for Label Delivery Instruction [LAB-62]

3.45.1 Scope

1045 This transaction is used by the Label Broker to query the Label Information Provider for specimen container labeling instructions related to an order or order group of laboratory tests for a patient.

3.45.2 Actor Roles

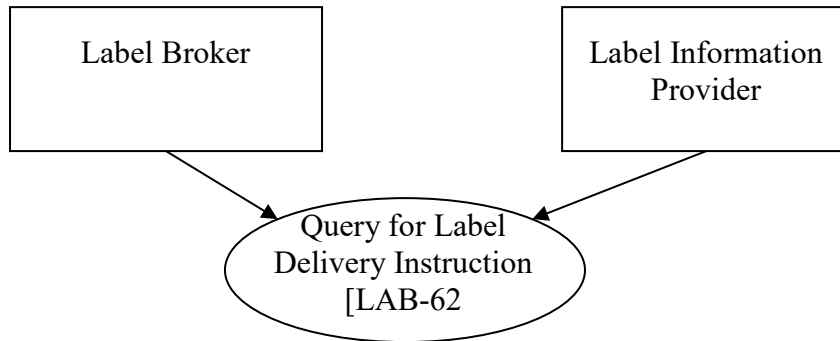

1050

Figure 3.45.2-1: Use Case Diagram

Table 3.45.2-1: Actor Roles

Actor:	Label Broker
Role:	Sends a query to the Label Information Provider to obtain the container delivery and labeling instructions related to a laboratory test orders for a patient.
Actor:	Label Information Provider
Role:	Responds to the query with the container delivery and labeling instructions

3.45.3 Referenced Standards

HL7 version 2.5.1: Chapter 5

3.45.4 Interaction Diagram

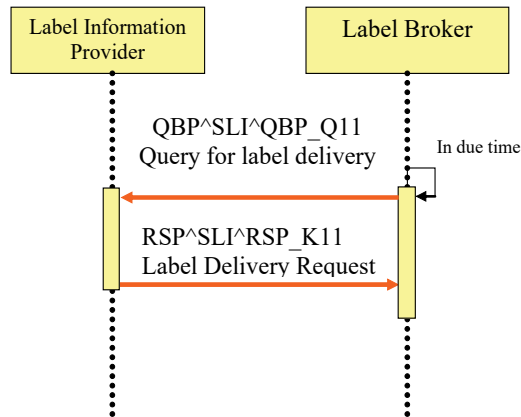

1055

Figure 3.45.4-1: Interaction diagram for Transaction LAB-62

3.45.4.1 Message Pair QBP^SLI^QBP_Q11 and RSP^SLI^RSP_K11

3.45.4.1.1 Trigger Events

1060 A patient is ready for specimen collection in relation with a laboratory test order. The application delivering the containers and labels implementing the Label Broker, needs to obtain the list of needed containers and labels corresponding to this test order.

3.45.4.1.2 Message Semantics

3.45.4.1.2.1 Query Message Static Definition

Table 3.45.4.1.2.1-1: QBP^SLI^QBP_Q11

Segment	Meaning	Usage	Card.	HL7 chapter
MSH	Message header	R	[1..1]	2
[{SFT}]	Software Segment	O	[0..*]	2
QPD	Query Parameter Definition	R	[1..1]	5
RCP	Response Control Parameter	R	[1..1]	5
[DSC]	Continuation Pointer	O	[0..1]	2

1065

MSH-9 - Message Type (MSG) SHALL be valued QBP^SLI^QBP_Q11.

3.45.4.1.2.2 Response Message Static Definition

Table 3.45.4.1.2.2-1: RSP^SLI^RSP_K11

Segment	Meaning	Usage	Card.	HL7 chapter
MSH	Message header	R	[1..1]	2
[{SFT}]	Software Segment	O	[0..*]	2
MSA	Message Acknowledgement	R	[1..1]	2
[ERR]	Error	O	[0..1]	2
QAK	Query Acknowledgement	R	[1..1]	5
QPD	Query Parameter Definition	R	[1..1]	5
[--- PATIENT begin	C	[0..1]	
PID	Patient Identification	R	[1..1]	3
PV1	Patient Visit	O	[0..1]	3
[{OBX}]	Observation related to the patient	O	[0..*]	7
{	--- SPECIMEN begin	R	[1..*]	
SPM	Specimen	R	[1..1]	7
[{OBX}]	Observation related to specimen	O	[0..*]	7
[{SAC}]	Specimen Container	O	[0..*]	13
{	--- ORDER begin	R	[1..*]	
ORC	Common Order	R	[1..1]	4
[{TQ1}]	Timing/Quantity	RE	[0..1]	4
[--- OBSERVATION REQUEST begin	O	[0..1]	
OBR	Observation Request	R	[1..1]	4
[TCD]	Test Code Details	O	[0..1]	13
[{OBX}]	Observation Result	O	[0..*]	7
]	--- OBSERVATION REQUEST end			
}	--- ORDER end			
}	--- SPECIMEN end			
]	--- PATIENT end			

1070 MSH-9 - Message Type (MSG) SHALL have its two first components respectively valued to "RSP" and "K11".

Condition predicate for PATIENT segment group: This segment group is present if and only if the LIP has labeling instructions available matching the query criteria. If not the response message SHALL contain only the first segments from MSH to QPD, the QAK segment indicating with QAK-2 "Query Response Status" valued "NF" (i.e., no data found, no error) that there was no available data matching the query parameters.

Usage of the SAC segment:

1080 In some cases, depending upon the laboratory organizational policy, more than one tube or label may be needed for the same SPECIMEN_ID. Each additional label/tube, other than the first one, is requested through a SAC segment appended below the SPM segment. The Laboratory Information Provider SHALL provide, in the OML_O33 message, immediately after the related SPM segment, as many SAC segment as there are additional labels requested. Refer to PaLM TF-2.x:C.8 for details on usage of the SAC segment.

3.45.4.1.2.3 QPD Segment (Query Parameters) Static Definition

1085 **Table 3.45.4.1.2.3-1: QPD segment**

SEQ	LEN	DT	Usage	Card.	TBL#	ITEM#	Element name
1	60	CE	R	[1..1]		01375	Message Query Name
2	32	ST	R	[1..1]		00696	Query Tag
3	80	CK	C	[0..1]		00105	Patient ID
4	250	CX	C	[0..1]		00149	Patient Visit Number
5	22	EI	C	[0..1]		00218	Placer Group Number
6	22	EI	C	[0..1]		00216	Placer Order Number,
7	22	EI	C	[0..1]		00217	Filler Order Number
8	53	DR	C	[0..1]			Search Period

QPD-1 Message Query Name (CE), required

Must be valued "SLI^Specimen Labeling Instructions^IHE_LABTF"

QPD-2 Query Tag (ST), required

1090 Unique to each query message instance. This identifies the query instance. It is used to match the response with the query.

QPD-3 Patient Identifier, conditional

Contains a patient unique identifier, as defined in PID-3.

QPD-4 Patient Visit Number, conditional

1095 Contains a patient visit number, as defined in PV1-19.

QPD-5 Placer Group Number, conditional

Contains a placer group number, as defined in ORC-4.

QPD-6 Placer Order Number, conditional

Contains a placer order number, as defined in transaction [LAB-1] (OBR-2).

1100 QPD-7 Filler Order Number, conditional

Contains a filler order number, as defined in transaction [LAB-1] (OBR-3).

Condition predicate: At least one of the fields QPD-3, QPD4, QPD-5, QPD-6, QPD-7 must be valued. In case QPD-3 or QPD-4 is used and there is more than one pending test order for the

1105 patient id or the visit number, it is the responsibility of the application implementing the Label Information Provider to decide whether to pick up one or all of the pending orders. The business rules governing this decision are out of the scope of this Integration Profile.

QPD-8 Search Period (DR), conditional

This field contains a range of date/times

HL7 Component Table - DR – Date/Time Range

SEQ	LEN	DT	OPT	TBL#	COMPONENT NAME	COMMENTS	SEC.REF.
1	26	TS	O		Range Start Date/Time		2.A.77
2	26	TS	O		Range End Date/Time		2.A.77

1110

Condition predicate: This criterion can be used when no order identifier is available, that is, when field QPD-5, QPD-6, QPD-7 are empty. QPD-8 is used in conjunction with QPD-3 or QPD-4.

1115 Use case: It happens that the patient comes to the specimen collection room on another day than the scheduled one. Therefore a range of dates is a convenient criterion if the only information brought by the patient is a patient identifier or a visit identifier.

3.45.4.1.2.4 RCP Segment

Table 3.45.4.1.2.4-1: RCP segment

SEQ	LEN	DT	Usage	Card.	TBL#	ITEM#	Element name
1	1	ID	R	[1..1]	0091	00027	Query Priority
2	10	CQ	O	[0..1]	0126	00031	Quantity Limited Request
3	60	CE	R	[1..1]	0394	01440	Response Modality
7	256	ID	O	[0..*]		01594	Segment group inclusion

1120 **RCP-1 Query Priority(ID), required**

Shall be fixed to "I" (=Immediate).

RCP-2 Quantity Limited Request (CQ), optional

1125 As for the 1st component "Quantity"(NM), Number of records that will be returned in each increment of the response. If no value is given, the entire response will be returned in a single increment.

As for the 2nd component "Units"(CE), "RD"(=Records) is always set. If no value is given, the default is RD.

RCP-3 Response Modality (CE), required

Shall be fixed to "R" (=Realtime).

1130 **RCP-7 Segment group inclusion (ID), optional**

Specifies those optional segment groups which are to be included in the response. If this field is not valued, all segment groups will be included.

3.45.4.1.3 Expected Actions

1135 The Label Information Provider parses the query parameters, and selects the appropriate pending test order(s) matching these parameters, according to its own business rules, and builds the response, which is sent back immediately to the Label Broker.

The Label Broker then delivers the labels and containers identified in the response message.

3.45.5 Security Considerations

None.

1140 **3.46 Labels and Containers Delivered [LAB-63]**

3.46.1 Scope

This transaction is used by the Label Broker to notify the effective delivery of labeled containers to the Label Information Provider.

3.46.2 Actor Roles

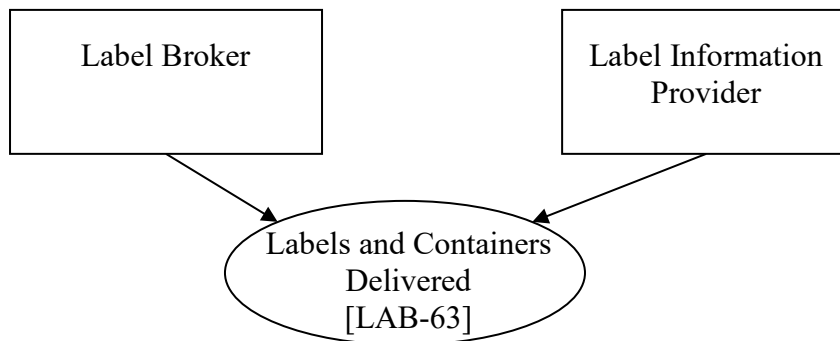

1145

Figure 3.46.2-1: Use Case Diagram

Table 3.46.2-1: Actor Roles

Actor:	Label Broker
Role:	Sends a message to the Label Information Provider to notify the effective labels printing and delivery of labeled containers

Actor:	Label Information Provider
Role:	Tracks the notification message from the Label Broker and updates the status of the process

3.46.3 Referenced Standards

HL7 V.2.5.1, Chapter 4

1150 3.46.4 Interaction Diagram

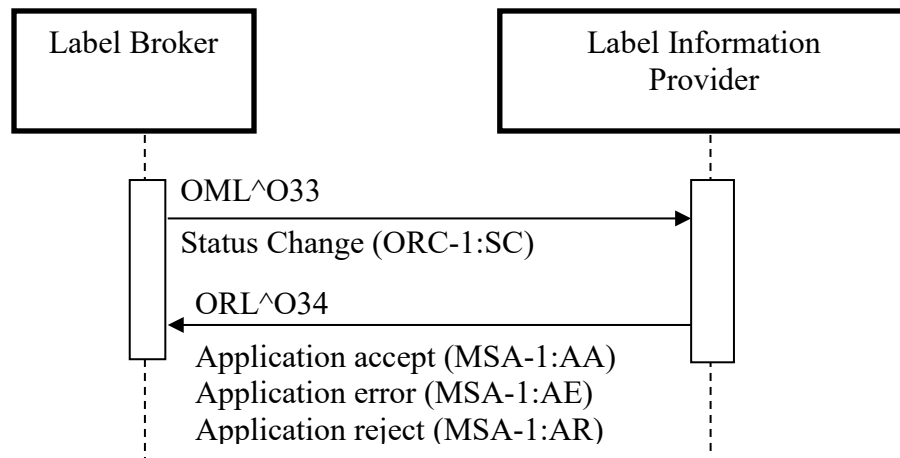

Figure 3.46.4-1: Interaction Diagram for Transaction LAB-63

3.46.4.1 Message Pair OML^O33 and ORL^O34

3.46.4.1.1 Trigger Events

1155 The system implementing the Label Broker has effectively delivered the containers and labels for specimen collection corresponding to a laboratory test order for a patient.

3.46.4.1.2 Message Semantics

1160 The OML message with Order Control Code ‘SC’ informs the Label Information Provider that the Label Broker has delivered the containers and labels related to a laboratory test order for a patient.

3.46.4.1.2.1 Static Definition of OML^O33

Table 3.46.4.1.2.1-1: OML^O33

Segment	Meaning	Usage	Card.	HL7 chapter
MSH	Message Header	R	[1..1]	2

Segment	Meaning	Usage	Card.	HL7 chapter
[--- PATIENT begin	R	[1..1]	
PID	Patient Identification	R	[1..1]	3
[PV1]	Patient Visit	RE	[0..1]	3
]	--- PATIENT end			
{	--- SPECIMEN begin	R	[1..*]	
SPM	Specimen	R	[1..1]	7
[{SAC}]	Specimen Container	O	[0..*]	
{	--- ORDER begin	R	[1..*]	
ORC	Common Order (for one battery)	R	[1..1]	4
[{TQ1}]	Timing Quantity	RE	[0..1]	4
[--- OBSERVATION REQUEST begin	O	[0..1]	
OBR	Observation Request	R	[1..1]	4
[TCD]	Test Code Details	O	[0..1]	13
[{O BX}]	Observation Result	O	[0..*]	7
]	--- OBSERVATION REQUEST end			
}	--- ORDER end			
}	--- SPECIMEN end			

1165 MSH-9 -Message Type (MSG) shall have its three components respectively valued to "OML", "O33" and "OML_O33".

This message conveys the notification of labeled containers delivered, in each SPECIMEN segment group. The SPM-27 field is valued with the type of labeled container; SPM-2 is the specimen (barcoded) id; SPM-4 is the specimen type.

The ORC-1 field SHALL be valued to 'SC' (Status Changed: labels and containers delivered).

1170 The OBR-25 field SHALL be valued to 'S', according to the Correlations of Status between ORC and OBR.

The SAC segment is used to notify the delivery of additional label/container for the specimen.

3.46.4.1.2.2 Static Definition of ORL^O34

Table 3.46.4.1.2.2-1: OML^O34

Segment	Meaning	Usage	Card.	HL7 chapter
MSH	Message header	R	[1..1]	2
MSA	Message Acknowledgement	R	[1..1]	2
[{ERR}]	Error	C	[0..*]	2
[--- RESPONSE begin	O	[0..1]	

Segment	Meaning	Usage	Card.	HL7 chapter
[PID]	Patient Identification	O	[0..1]	3
{	--- SPECIMEN begin	O	[0..*]	
SPM	Specimen	R	[1..1]	7
[{SAC}]	Specimen Container	O	[0..*]	13
[{	--- ORDER begin	O	[0..*]	
ORC	Common Order	R	[1..1]	4
[{TQ1 }]	Timing/Quantity	RE	[0..1]	4
[OBR]	Observation Request	R	[1..1]	4
}]	--- ORDER end			
}	--- SPECIMEN end			
]	--- RESPONSE end			

1175

MSH-9 -Message Type (MSG) shall have its three components respectively valued to "ORL", "O34" and "ORL_O34".

Condition predicate for use of the ERR segment:

1180 The ERR segment SHALL be used whenever the Label Information Provider does not accept the labeled notification (MSA-1 = AE or AR).

3.46.4.1.2.3 OBR Segment Static Definition

Table 3.46.4.1.2.3-1: OBR Segment

SEQ	LEN	DT	Usage	Card.	TBL#	ITEM#	Element name
1	4	SI	O	[0..1]		00237	Set ID – OBR
2	22	EI	R	[1..1]		00216	Placer Order Number
3	22	EI	RE	[0..1]		00217	Filler Order Number
4	250	CE	R	[1..1]		00238	Universal Service Identifier
5	2	ID	X	[0..0]		00239	Priority – OBR
6	26	TS	X	[0..0]		00240	Requested Date/Time
7	26	TS	X	[0..0]		00241	Observation Date/Time #
8	26	TS	X	[0..0]		00242	Observation End Date/Time #
9	20	CQ	X	[0..0]		00243	Collection Volume *
10	250	XCN	O	[0..*]		00244	Collector Identifier *
11	1	ID	RE	[0..1]	0065	00245	Specimen Action Code *
12	250	CE	X	[0..0]		00246	Danger Code
13	300	ST	X	[0..0]		00247	Relevant Clinical Information
14	26	TS	X	[0..0]		00248	Specimen Received Date/Time *
15	300	SPS	X	[0..0]		00249	Specimen Source

IHE Pathology & Laboratory Medicine Technical Framework, Vol. 2c (PaLM TF-2c):
Transactions

SEQ	LEN	DT	Usage	Card.	TBL#	ITEM#	Element name
16	250	XCN	R	[1..1]		00226	Ordering Provider
17	250	XTN	RE	[0..2]		00250	Order Callback Phone Number
18	60	ST	X	[0..0]		00251	Placer Field 1
19	60	ST	X	[0..0]		00252	Placer Field 2
20	60	ST	X	[0..0]		00253	Filler Field 1 +
21	60	ST	X	[0..0]		00254	Filler Field 2 +
22	26	TS	X	[0..0]		00255	Results Rpt/Status Chng - Date/Time +
23	40	MOC	X	[0..0]		00256	Charge to Practice +
24	10	ID	C	[0..1]	0074	00257	Diagnostic Serv Sect ID
25	1	ID	R	[0..0]	0123	00258	Result Status +
26	400	PRL	X	[0..0]		00259	Parent Result +
27	200	TQ	X	[0..0]		00221	Quantity/Timing
28	250	XCN	O	[0..*]		00260	Result Copies To
29	200	EIP	X	[0..0]		00261	Parent
30	20	ID	X	[0..0]	0124	00262	Transportation Mode
31	250	CE	O	[0..1]		00263	Reason for Study
32	200	NDL	O	[0..1]		00264	Principal Result Interpreter +
33	200	NDL	O	[0..1]		00265	Assistant Result Interpreter +
34	200	NDL	O	[0..1]		00266	Technician +
35	200	NDL	O	[0..1]		00267	Transcriptionist +
36	26	TS	O	[0..1]		00268	Scheduled Date/Time +
37	4	NM	O	[0..1]		01028	Number of Sample Containers *
38	250	CE	O	[0..1]		01029	Transport Logistics of Collected Sample *
39	250	CE	O	[0..1]		01030	Collector's Comment *
40	250	CE	X	[0..0]		01031	Transport Arrangement Responsibility
41	30	ID	X	[0..0]	0224	01032	Transport Arranged
42	1	ID	X	[0..0]	0225	01033	Escort Required
43	250	CE	X	[0..0]		01034	Planned Patient Transport Comment
44	250	CE	O	[0..1]	0088	00393	Procedure Code
45	250	CWE	O	[0..1]	0340	01316	Procedure Code Modifier
46	250	CE	O	[0..1]	0411	01474	Placer Supplemental Service Information
47	250	CE	O	[0..1]	0411	01475	Filler Supplemental Service Information
48	250	CWE	X	[0..0]	0476	01646	Medically Necessary Duplicate Procedure Reason.
49	2	IS	O	[0..1]	0507	01647	Result Handling

3.46.4.1.3 Expected Actions

1185 The Label Information Provider tracks the container delivery information received, and acknowledges the message with an ORL^O34 message with either “Accept” (MSA-1 = AA) or “Reject” (MSA-1 = AR) or “Error” (MSA-1=AE).

3.46.5 Security Considerations

None.

1190

Glossary

The IHE Glossary can be found as an appendix to the *IHE Technical Frameworks General Introduction* published on [this page](#).

1195