

Integrating the Healthcare Enterprise



5 **IHE Pathology and Laboratory Medicine (PaLM)
Technical Framework**

10 **Volume 2a
(PaLM TF-2a)
Transactions**

15

20 **Revision 9.0 - Final Text
August 7, 2018**

25 **Please verify you have the most recent version of this document, which is published [here](#).**

CONTENTS

1	Introduction.....	7
30	1.1 Introduction to IHE.....	7
	1.2 Intended Audience.....	7
	1.3 Overview of Technical Framework Volume 2.....	7
	1.4 Comment Process.....	8
	1.5 Copyright Licenses.....	8
35	1.5.1 Copyright of Base Standards.....	8
	1.6 Trademark.....	9
	1.7 Disclaimer Regarding Patent Rights.....	9
	1.8 History of Document Changes.....	9
2	Conventions.....	11
40	2.1 Transaction Modeling and Profiling Conventions.....	11
	2.2 Additional Standards Profiling Conventions.....	11
	2.2.1 Message Granularity for Transactions Specified in this Volume.....	11
	2.3 Use of Coded Entities and Coding Schemes.....	11
3	IHE Transactions.....	12
45	3.1 Placer Order Management [LAB-1].....	12
	3.1.1 Scope.....	12
	3.1.2 Actor Roles.....	13
	3.1.3 Referenced Standards.....	13
	3.1.3.1 HL7 2.5 OML Message Structures.....	13
50	3.1.3.2 Constraints on OML Message Structures added by Transaction [LAB-1].....	14
	3.1.4 Interaction Diagram.....	15
	3.1.4.1 Message OML^O21 and its Acknowledgement ORL^O22.....	17
	3.1.4.1.1 Trigger Events.....	17
	3.1.4.1.2 Message Semantics.....	18
55	3.1.4.1.2.1 OML^O21 Static Definition.....	18
	3.1.4.1.2.2 ORL^O22 Static Definition.....	19
	3.1.4.1.2.3 OBR Segment Static Definition.....	20
	3.1.4.1.3 Expected Actions.....	24
	3.1.4.2 Message OML^O33 and its Acknowledgement ORL^O34.....	25
60	3.1.4.2.1 Trigger Events.....	25
	3.1.4.2.2 Message Semantics.....	25
	3.1.4.2.2.1 OML^O33 Static Definition.....	25
	3.1.4.2.2.2 ORL^O34 Static Definition.....	27
	3.1.4.2.2.3 OBR Segment Static Definition.....	27
	3.1.4.2.3 Expected Actions.....	27
65	3.1.4.3 Message OML^O35 and its Acknowledgement ORL^O36.....	28
	3.1.4.3.1 Trigger Events.....	28
	3.1.4.3.2 Message Semantics.....	28
	3.1.4.3.2.1 OML^O35 Static Definition.....	28

70	3.1.4.3.2.2 ORL^O36 Static Definition.....	29
	3.1.4.3.2.3 OBR Segment Static Definition.....	30
	3.1.4.3.3 Expected Actions	30
	3.1.5 Security Considerations	30
	3.2 Filler Order Management [LAB-2].....	31
75	3.2.1 Scope.....	31
	3.2.2 Actor Roles	31
	3.2.3 Referenced Standards	31
	3.2.3.1 HL7 2.5 OML Message Structures.....	32
	3.2.4 Interaction Diagram	32
80	3.2.4.1 Message OML^O21 and its Acknowledgement ORL^O22.....	32
	3.2.4.1.1 Trigger Events.....	32
	3.2.4.1.2 Message Semantics	33
	3.2.4.1.2.1 OML^O21 Static Definition	33
	3.2.4.1.2.2 ORL^O22 Static Definition.....	33
85	3.2.4.1.2.3 OBR Segment Static Definition.....	33
	3.2.4.1.3 Expected Actions	36
	3.2.4.2 Message OML^O33 and its Acknowledgement ORL^O34.....	36
	3.2.4.2.1 Trigger Events.....	36
	3.2.4.2.2 Message Semantics	36
90	3.2.4.2.2.1 OML^O33 Static Definition	36
	3.2.4.2.2.2 ORL^O34 Static Definition.....	36
	3.2.4.2.2.3 OBR Segment Static Definition.....	36
	3.2.4.2.3 Expected Actions	36
	3.2.4.3 Message OML^O35 and its Acknowledgement ORL^O36.....	36
95	3.2.4.3.1 Trigger Events.....	36
	3.2.4.3.2 Message Semantics	36
	3.2.4.3.2.1 OML^O35 Static Definition	36
	3.2.4.3.2.2 ORL^O36 Static Definition.....	37
	3.2.4.3.2.3 OBR Segment Static Definition.....	37
100	3.2.4.3.3 Expected Actions	37
	3.2.5 Security Consideration.....	37
	3.3 Order Results Management [LAB-3].....	38
	3.3.1 Scope.....	38
	3.3.2 Actor Roles	38
105	3.3.3 Referenced Standards	39
	3.3.3.1 HL7 2.5 Result Message Structures	39
	3.3.3.2 Constraints on Result Message Structures added by Transaction [LAB-3].....	39
	3.3.4 Interaction Diagram	39
	3.3.4.1 Message OUL^R22	41
110	3.3.4.1.1 Trigger Events.....	41
	3.3.4.1.2 Message Semantics	42
	3.3.4.1.2.1 OUL^R22 Static Definition.....	42

	3.3.4.1.2.2 OBR Segment Static Definition.....	43
	3.3.4.1.2.3 Semantic with the Option Report Facsimile for Order Group.....	47
115	3.3.4.1.3 Expected Actions	50
	3.3.4.2 Message ORU^R01	50
	3.3.4.2.1 Trigger Events.....	50
	3.3.4.2.2 Message Semantics	50
	3.3.4.2.2.1 ORU^R01 Static Definition.....	50
120	3.3.4.2.2.2 OBR Segment Static Definition.....	52
	3.3.4.2.2.3 Semantic with the Option Report Facsimile for Order Group.....	52
	3.3.4.2.3 Expected Actions	52
	3.3.5 Security Considerations.....	52
	3.4 Work Order Management [LAB-4]	53
125	3.4.1 Scope.....	53
	3.4.2 Actor Roles	53
	3.4.3 Referenced Standards	53
	3.4.3.1 Trigger Events (ORC-1 values) Supported by Transaction [LAB-4]	54
	3.4.4 Interaction Diagram	54
130	3.4.4.1 Message OML^O21 and its Acknowledgement ORL^O22	54
	3.4.4.1.1 Trigger Events.....	54
	3.4.4.1.2 Message Semantics	55
	3.4.4.1.2.1 OML^O21 Static Definition	55
	3.4.4.1.2.2 ORL^O22 Static Definition	56
135	3.4.4.1.2.3 OBR Segment Static Definition.....	57
	3.4.4.1.2.4 TCD Segment Static Definition.....	59
	3.4.4.1.3 Expected Actions	59
	3.4.4.2 Message OML^O33 and its Acknowledgement ORL^O34.....	60
140	3.4.4.2.1 Trigger Events.....	60
	3.4.4.2.2 Message Semantics	60
	3.4.4.2.2.1 OML^O33 Static Definition	60
	3.4.4.2.2.2 ORL^O34 Static Definition	61
	3.4.4.2.2.3 OBR Segment Static Definition.....	61
	3.4.4.2.2.4 TCD Segment Static Definition.....	62
145	3.4.4.2.3 Expected Actions	62
	3.4.4.3 Message OML^O35 and its Acknowledgement ORL^O36.....	62
	3.4.4.3.1 Trigger Events.....	62
	3.4.4.3.2 Message Semantics	62
	3.4.4.3.2.1 OML^O35 Static Definition	62
150	3.4.4.3.2.2 ORL^O36 Static Definition	63
	3.4.4.3.2.3 OBR Segment Static Definition.....	64
	3.4.4.3.2.4 TCD Segment Static Definition.....	64
	3.4.4.3.3 Expected Actions	64
	3.4.5 Security Considerations.....	64
155	3.5 Test Results Management [LAB-5].....	65

	3.5.1 Scope.....	65
	3.5.2 Actor Roles	65
	3.5.3 Referenced Standards	65
	3.5.4 Interaction Diagram	66
160	3.5.4.1 Message OUL^R22 and its Acknowledgement ACK^R22.....	66
	3.5.4.1.1 Trigger Events.....	66
	3.5.4.1.2 Message Semantics	66
	3.5.4.1.2.1 OUL^R22 Static Definition	66
	3.5.4.1.2.2 ACK^R22 Static Definition.....	67
165	3.5.4.1.3 Expected Actions	67
	3.5.4.2 Message OUL^R23 and its Acknowledgement ACK^R23.....	67
	3.5.4.2.1 Trigger Events.....	68
	3.5.4.2.2 Message Semantics	68
	3.5.4.2.2.1 OUL^R23 Static Definition	68
170	3.5.4.2.2.2 ACK^R23 Static Definition.....	69
	3.5.4.2.3 Expected Actions	69
	3.5.5 Security Considerations	69
	3.6 Specimen Work Order Step Download [LAB-21].....	70
	3.6.1 Scope.....	70
175	3.6.2 Actor Roles	70
	3.6.3 Referenced Standards	70
	3.6.4 Interaction Diagram	71
	3.6.4.1 Message OML^O33 and its Acknowledgement.....	71
	3.6.4.1.1 Trigger Events.....	71
180	3.6.4.1.2 Message Semantics	71
	3.6.4.1.2.1 OML^O33 Static Definition	71
	3.6.4.1.2.2 ORL^O34 Static Definition	72
	3.6.4.1.2.3 OBR Segment Static Definition.....	73
	3.6.4.1.2.4 TCD Segment Static Definition.....	74
185	3.6.4.1.3 Expected Actions	75
	3.6.5 Security Considerations	75
	3.7 Specimen Work Order Step Query [LAB-22]	76
	3.7.1 Scope.....	76
	3.7.2 Actor Roles	76
190	3.7.3 Referenced Standards	76
	3.7.4 Interaction Diagram	77
	3.7.4.1 Message QBP^WOS and its Response RSP^WOS.....	77
	3.7.4.1.1 Trigger Events.....	77
	3.7.4.1.2 Message Semantics	77
195	3.7.4.1.2.1 QBP^WOS Static Definition	77
	3.7.4.1.2.2 RSP^WOS Static Definition.....	78
	3.7.4.1.2.3 QPD Segment Static Definition.....	79
	3.7.4.1.2.4 RCP Segment Static Definition	80

	3.7.4.1.3 Expected Actions	81
200	3.7.5 Security Considerations	81
	3.8 Specimen Work Order Step Status Change [LAB-26]	82
	3.8.1 Scope.....	82
	3.8.2 Actor Roles	82
	3.8.3 Referenced Standards	82
205	3.8.4 Interaction Diagram	83
	3.8.4.1 Message SSU and its Acknowledgement	83
	3.8.4.1.1 Trigger Events.....	83
	3.8.4.1.2 Message Semantics	83
	3.8.4.1.2.1 SSU^U03 Static Definition.....	83
210	3.8.4.1.2.2 ACK^U03 Static Definition.....	84
	3.8.4.1.3 Expected Actions	84
	3.8.5 Security Considerations	84
	Appendices.....	85
	Glossary	86
215		

1 Introduction

This document, Volume 2a of the IHE Pathology and Laboratory Medicine (PaLM) Technical Framework, defines transactions used in two of the profiles of the IHE Pathology and Laboratory
220 Medicine domain: the Laboratory Testing Workflow (LTW) Profile and the Laboratory Device
Automation (LDA) Profile.

1.1 Introduction to IHE

Integrating the Healthcare Enterprise (IHE) is an international initiative to promote the use of
225 standards to achieve interoperability among health information technology (HIT) systems and
effective use of electronic health records (EHRs). IHE provides a forum for care providers, HIT
experts and other stakeholders in several clinical and operational domains to reach consensus on
standards-based solutions to critical interoperability issues.

The primary output of IHE is system implementation guides, called IHE Profiles. IHE publishes
230 each profile through a well-defined process of public review and trial implementation and
gathers profiles that have reached final text status into an IHE Technical Framework, of which
this volume is a part.

For more general information regarding IHE, refer to www.ihe.net. It is strongly recommended
that, prior to reading this volume, the reader familiarizes themselves with the concepts defined in
the *IHE Technical Frameworks General Introduction*, which is published [here](#).

1.2 Intended Audience

The intended audience of IHE Technical Frameworks Volume 2 is:

- IT departments of healthcare institutions
- Technical staff of vendors participating in the IHE initiative
- Experts involved in standards development

1.3 Overview of Technical Framework Volume 2

Volume 2 is comprised of several distinct sections:

- Section 1 provides background and reference material.
- Section 2 presents the conventions used in this volume to define the transactions.
- Section 3 defines Pathology and Laboratory Medicine transactions in detail, specifying
245 the roles for each actor, the standards employed, the information exchanged, and in some
cases, implementation options for the transaction.

The appendices in Volume 2 provide clarification of technical details of the IHE data model and
transactions. A glossary of terms and acronyms used in the IHE Technical Framework, including
those from relevant standards, is provided in the *IHE Technical Framework General*

250 *Introduction*, which is published on [this page](#). Due to the length of the document, some domains may divide Volume 2 into smaller volumes labeled 2a, 2b, etc. In this case, the Volume 2 appendices are gathered in Volume 2x. Code and message samples may also be stored on the IHE ftp server. In this case, explicit links to the ftp server will be provided in the transaction text.

1.4 Comment Process

255 IHE International welcomes comments on this document and the IHE initiative. They can be submitted by sending an email to the co-chairs and secretary of the Pathology and Laboratory Medicine domain committees at palm@ihe.net.

1.5 Copyright Licenses

260 IHE International hereby grants to each Member Organization, and to any other user of these documents, an irrevocable, worldwide, perpetual, royalty-free, nontransferable, nonexclusive, non-sublicensable license under its copyrights in any IHE profiles and Technical Framework documents, as well as any additional copyrighted materials that will be owned by IHE International and will be made available for use by Member Organizations, to reproduce and distribute (in any and all print, electronic or other means of reproduction, storage or
265 transmission) such IHE Technical Documents.

The licenses covered by this Copyright License are only to those copyrights owned or controlled by IHE International itself. If parts of the Technical Framework are included in products that also include materials owned or controlled by other parties, licenses to use those products are beyond the scope of this IHE document and would have to be obtained from that other party.

270 1.5.1 Copyright of Base Standards

IHE technical documents refer to and make use of a number of standards developed and published by several standards development organizations. All rights for their respective base standards are reserved by these organizations. This agreement does not supersede any copyright provisions applicable to such base standards.

275 Health Level Seven, Inc. has granted permission to IHE to reproduce tables from the HL7^{®1} standard. The HL7 tables in this document are copyrighted by Health Level Seven, Inc. All rights reserved. Material drawn from these documents is credited where used.

280 The Clinical and Laboratory Standards Institute (CLSI) has granted to IHE the permission to reproduce tables and figures from the POCT1-A standard. The POCT1-A tables and figures in the IHE Pathology and Laboratory Medicine Technical Framework are copyrighted by CLSI. All rights reserved.

IHE grants permission to CLSI to reproduce either parts of the Pathology and Laboratory Medicine Technical Framework.

¹ HL7 is the registered trademark of Health Level Seven International.

1.6 Trademark

285 IHE® and the IHE logo are trademarks of the Healthcare Information Management Systems
Society in the United States and trademarks of IHE Europe in the European Community. They
may only be used with the written consent of the IHE International Board Operations
Committee, which may be given to a Member Organization in broad terms for any use that is
consistent with the IHE mission and operating principles.

290 1.7 Disclaimer Regarding Patent Rights

Attention is called to the possibility that implementation of the specifications in this document
may require use of subject matter covered by patent rights. By publication of this document, no
position is taken with respect to the existence or validity of any patent rights in connection
therewith. IHE International is not responsible for identifying Necessary Patent Claims for which
295 a license may be required, for conducting inquiries into the legal validity or scope of Patents
Claims or determining whether any licensing terms or conditions provided in connection with
submission of a Letter of Assurance, if any, or in any licensing agreements are reasonable or
non-discriminatory. Users of the specifications in this document are expressly advised that
300 determination of the validity of any patent rights, and the risk of infringement of such rights, is
entirely their own responsibility. Further information about the IHE International patent
disclosure process including links to forms for making disclosures is available at
http://www.ihe.net/Patent_Disclosure_Process. Please address questions about the patent
disclosure process to the secretary of the IHE International Board: secretary@ihe.net.

1.8 History of Document Changes

305 This section provides a brief summary of changes and additions to this document.

Date	Document Revision	Change Summary
July 2016	7.0	Adoption of IHE_TF_Template_Vol2_Rev1.0_2014-07-01, Incorporation of the LAW Profile “Final Text”, Update of the LDA Profile by removal of the transactions transferred to LAW. Incorporation of option “labels & containers delivered” for the LBL Profile. Reorganization of Vol 2 content in 4 volumes: - 2a contains LTW and LDA transactions (including CP-LAB-250), - 2b contains LAW transactions and specific appendices, - 2c contains LBL, LPOCT and LCSD transactions - 2x contains common appendices
June 2017	8.0	Harmonization of the description of field OBR-10 across LTW transactions (CP 254)

Date	Document Revision	Change Summary
August 2018	9.0	<ul style="list-style-type: none">- Refine transitions of OBX-11, OBR-25, ORC-5 in [LAB-3], when correction after final (integration of CP 256)- Harmonization: LDA Profile references HL7 2.5.1 instead of 2.5 (integration of CP 261)- Moved Appendix A of Volume 2a to Volume 2x (as Appendix F)

2 Conventions

310 This document has adopted the following conventions for representing the framework concepts and specifying how the standards upon which the IHE Technical Framework is based shall be applied.

2.1 Transaction Modeling and Profiling Conventions

Refer to PaLM TF-2x: 2.1

2.2 Additional Standards Profiling Conventions

315 Refer to PaLM TF-2x: 2.2.

2.2.1 Message Granularity for Transactions Specified in this Volume

A message is generated from one trigger event in the real world. Therefore a message is related to one single business object:

- A [LAB-1], [LAB-2] or [LAB-3] message is related to one Order or to one Order Group.
- 320 • A [LAB-4] or [LAB-5] message is related to one Work Order.
- A [LAB-21], [LAB-22], or [LAB-26] message is related to one SWOS.

2.3 Use of Coded Entities and Coding Schemes

325 In the cases where coding schemes are not explicitly identified by base standards such as HL7, nor by the IHE PaLM Technical Framework, implementations may utilize any controlled vocabulary provided any licensing/copyright requirements are satisfied.

3 IHE Transactions

This section defines each IHE Pathology and Laboratory Medicine transaction in detail, specifying the standards used and the information transferred.

330 3.1 Placer Order Management [LAB-1]

3.1.1 Scope

This transaction is used by the Order Placer to place an Order Group (i.e., a set of Orders to be tested together for a patient) or a standalone Order to the Order Filler. The transaction enables both Order Placer and Order Filler to notify all subsequent changes of status and/or content of each Order to the other side.

An Order contains a battery or a single test requested to a laboratory. The tests are to be performed on one or more in vitro specimens collected from the patient.

An Order accepted by the Order Filler is acknowledged to the Order Placer as scheduled by the laboratory: Order Status ORC-5 = “SC” (scheduled)

340 When the accurate specimens for this Order are accepted or collected by the laboratory the Order Filler notifies the start of the process to the Order Placer: Order Status ORC-5 = “IP” (in process).

When the first results of an Order are released the Order Filler notifies to the Order Placer the Order Status ORC-5 = “A” (some, but not all, results available).

345 When all results of an Order are released the Order Filler notifies to the Order Placer the Order Status ORC-5 = “CM” (completed).

Both Order Placer and Order Filler may update or cancel an existing Order. Update consists in replacing the ordered test or battery by another one.

An Order canceled ends with Order Status ORC-5 = “CA” (canceled).

350 To request an additional battery or test in an existing Order Group the Order Placer places a new Order added to this Order Group.

To generate an additional battery or test in an existing Order Group the Order Filler uses transaction [LAB-2], not [LAB-1].

355 In addition, if the “Report Facsimile For Order Group” Option is activated, this transaction MAY include into an Order Group placed, the request for the facsimile of the report related to that Order Group.

3.1.2 Actor Roles

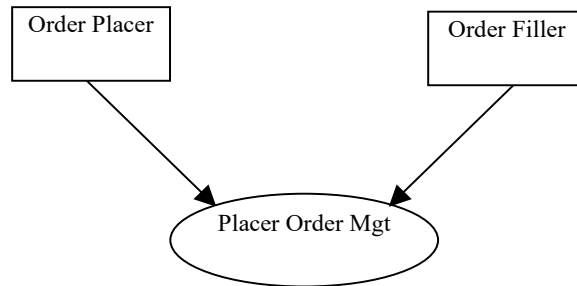

Figure 3.1.2-1: Use Case Diagram

360

Table 3.1.2-1: Actor Roles

Actor:	Order Placer
Role:	Places, updates, cancels and nullifies orders. Receives acceptance or rejection from the Order Filler. Receives Order content and status changes from the Order Filler.
Actor:	Order Filler
Role:	Receives orders. Checks the specimens required, and notifies the Order Placer of acceptance or refusal. Receives Order content changes from the Order Placer. Notifies content updates (removed batteries/tests) to the Order Placer. Notifies status changes (scheduled, started, cancelled, completed) to the Order Placer.

3.1.3 Referenced Standards

HL7 version 2.5.1:

- Chapter 2: "Control" --> generic segments and data types
- Chapter 3: "ADT" --> PID and PV1 segments
- Chapter 4: "Order Entry" --> OML and ORL messages
- Chapter 7: "Observation Reporting" --> SPM segment
- Chapter 13: "Clinical Laboratory Automation" --> SAC segment

365

3.1.3.1 HL7 2.5 OML Message Structures

370 HL7 v2.5 chapter 4, offers three different message structures for the OML message type:

- OML^O21^OML_O21: **laboratory order message**. This is a battery/panel/test-centric message structure. The applicative acknowledgement is ORL^O22^ORL_O22
- 375 • OML^O33^OML_O33: **Laboratory order for multiple orders related to a single specimen**. This is a specimen-centric structure providing for each specimen a list of containers and a list of batteries (ORC/OBR segment groups) using this specimen. The batteries are not related to the containers. The applicative acknowledgement is ORL^O34^ORL_O34.
- 380 • OML^O35^OML_O35: **Laboratory order for multiple orders related to a single container of a specimen**. This message structure provides for each specimen a list of containers, and for each container the list of batteries that are to be performed on that container. This structure is more appropriate when the ordered batteries are sorted by container. The applicative acknowledgement is ORL^O36^ORL_O36.

3.1.3.2 Constraints on OML Message Structures added by Transaction [LAB-1]

Transaction [LAB-1] supports the three message structures listed above, and adds the following
385 constraints:

- Each of the three message structures can convey in field ORC-1 the same trigger event, which can be:
 - the creation of a new order (NW) by the Order Placer,
 - the replacement (RP) of a test or battery requested by the Order Placer,
 - 390 • the replacement unsolicited (RU) of a test or battery decided on the Order Filler side,
 - the status change (SC) of an order recorded by the Order Filler,
 - the cancellation (CA) of an order requested by the Order Placer,
 - the cancellation unsolicited (OC) of an order decided on the Order Filler side.
- [LAB-1] carries all clinical observations provided by the ordering provider, such as
395 allergy, therapy, diagnosis, temperature, urine volume, blood pressure, within observation segments (OBX) that accompany the order. This choice has been made to simplify the building and parsing of the messages. All these specific patient observations are sent in the OML message, in OBX segments.
- [LAB-1] restrains timing/quantity to one execution per order. The main reason for this
400 choice is:
 - The only operation that would have needed the iteration features provided by the segment TQ1 is the specimen collection. In this transaction this operation is not triggered by any message: It is an internal operation performed within the Order Placer or the Order Filler,
405 depending on the organization. All orders sent to laboratories require one single execution, even the studies based on a temporal series of specimens. For example a serum

glucose tolerance study is an atomic order to be performed once, taking into account all the specimens to be tested.

3.1.4 Interaction Diagram

410 In all interactions below, the initiator chooses the OML message structure appropriate to its orders. The responder SHALL respond with the corresponding ORL message structure. An OML message shall be responded to with exactly one ORL message. The Filler Order Number (assigned by the Order Filler application) is required in the ORL messages.

415 Simplification of the message flow when Order Placer and Order Results Tracker Actors are grouped:

The blue message flows “Order status change” notified by the Order Filler to the Order Placer in the figure below happen only when the Order Placer and the Order Results Tracker are not grouped together.

420 Whenever the Order Placer and the Order Results Tracker are grouped in the same system, the transaction [LAB-3] message carrying the status change and possible new results is sufficient to inform that application of the new status of the Order. An “Order status change” message in [LAB-1] would be redundant in that case. Therefore, when exchanging with a grouped Order Placer/Order Results Tracker, the Order Filler SHALL NOT send the redundant message “Order Status Change” from transaction [LAB-1] (marked in blue in the figure below).

425 The figure below shows the flow of messages in the normal process of a placer order, from placing of the order by the Order Placer, to the "order completed" event notified by the Order Filler.

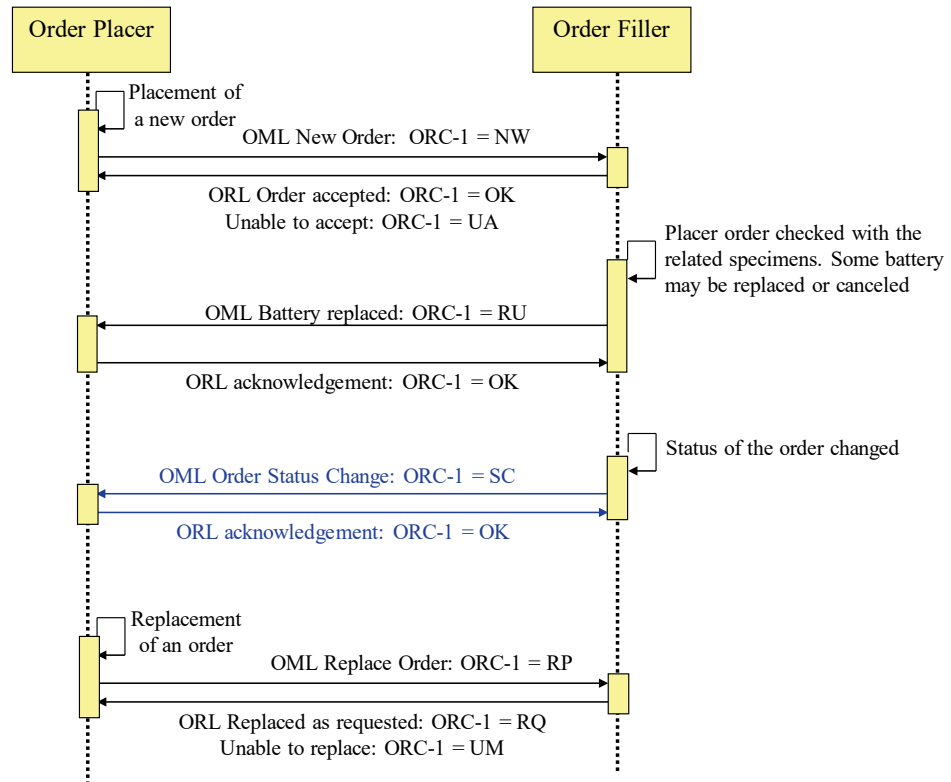

Figure 3.1.4-1: Normal process of a placer order

430 The figure below shows the flow of messages in case of cancellation of an order by the Order Placer. The Order Filler accepts the cancellation only if the processing has not started yet, particularly if no work order has been sent to the Automation Manager (through transaction [LAB-4]).

435

440

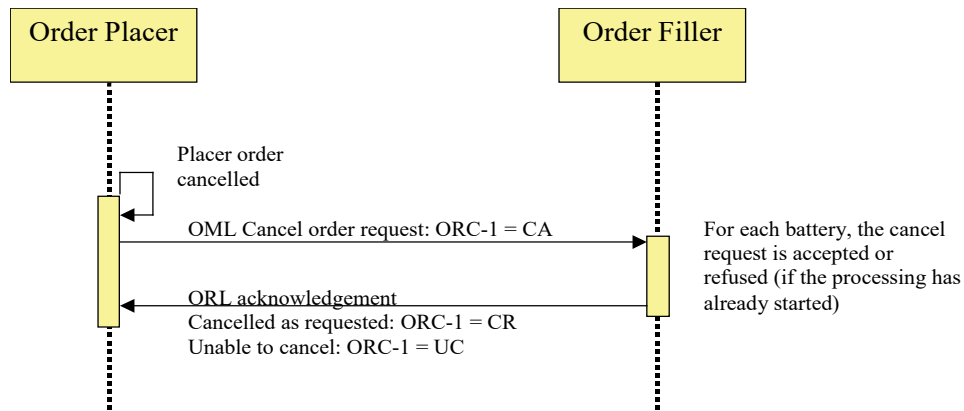

Figure 3.1.4-2: Cancellation of an order by the Order Placer

445 The figure below shows the flow of messages in case of cancellation of an order by the Order Filler.

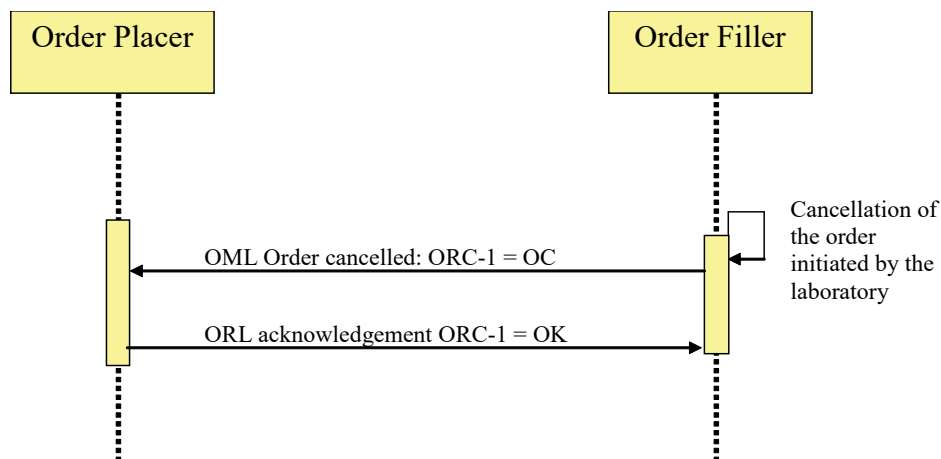

Figure 3.1.4-3: Cancellation by Order Filler

3.1.4.1 Message OML^O21 and its Acknowledgement ORL^O22

450 This battery/panel/test centric message pair contains a list of ordered batteries belonging to zero or one Order Group, a list of specimens underneath each battery/panel/test, and a list of containers underneath each specimen. This structure implies duplication of specimen/container information whenever two batteries use the same specimen. It is particularly appropriate for ordering batteries that need several specimens (e.g., creatinine clearance, glucose tolerance test).

455 3.1.4.1.1 Trigger Events

The real events conveyed by ORC-1 are listed in Section 3.1.3.2.

3.1.4.1.2 Message Semantics

3.1.4.1.2.1 OML^O21 Static Definition

Table 3.1.4.1.2.1-1: OML^O21 Message Static Definition

Segment	Meaning	Usage	Card.	HL7 chapter
MSH	Message Header	R	[1..1]	2
[--- PATIENT begin	RE	[0..1]	
PID	Patient Identification	R	[1..1]	3
[--- PATIENT_VISIT begin	RE	[0..1]	
PV1	Patient Visit	R	[1..1]	3
]	--- PATIENT_VISIT end			
]	--- PATIENT end			
{	--- ORDER begin	R	[1..*]	
ORC	Common Order (for one battery)	R	[1..1]	4
[{	--- TIMING begin	RE	[0..1]	
TQ1	Timing Quantity	R	[1..1]	4
}]	--- TIMING end			
	--- OBSERVATION REQUEST begin	R	[1..1]	
OBR	Observation Request	R	[1..1]	4
{ [NTE] }	Notes and Comments	O	[0..*]	2
[{	--- OBSERVATION begin	O	[0..*]	
OBX	Observation Result	R	[1..1]	7
[{NTE}]	Comment of the result	O	[0..*]	2
}]	--- OBSERVATION end			
[{	--- SPECIMEN begin	O	[0..*]	
SPM	Specimen	R	[1..1]	7
[{SAC}]	Container	RE	[0..*]	13
}]	--- SPECIMEN end			
[{	--- PRIOR_RESULT begin	O	[0..*]	
PV1	Patient Visit – previous result	R	[1..1]	3
{	--- ORDER_PRIOR begin	R	[1..*]	
ORC	Common Order - previous result	R	[1..1]	4
OBR	Order Detail - previous result	R	[1..1]	4
{ [NTE] }	Notes and Comments - previous result	O	[0..*]	2
{	--- OBSERVATION_PRIOR begin	R	[1..*]	
OBX	Observation/Result - previous result	R	[1..1]	7
{ [NTE] }	Notes and Comments - previous result	O	[0..*]	2
}	--- OBSERVATION_PRIOR end			
}	--- ORDER_PRIOR end			

Segment	Meaning	Usage	Card.	HL7 chapter
]} }	--- PRIOR_RESULT end			
	--- OBSERVATION REQUEST end			
}	--- ORDER end			

460

Field MSH-9 - Message Type (MSG) shall have its three components respectively valued to “OML”, “O21” and “OML_O21”.

The triplet (ORC, TQ1, OBR) represents the Order (i.e., an ordered battery/test). In case of an Order Group, this triplet is repeated as many times as there are Orders in the Order Group.

465

The OBSERVATION repeatable segment group carries observations given by the ordering provider (patient temperature, blood pressure, weight, ...) with eventual comments (NTE).

The PRIOR RESULT segment group provides the prior results obtained for the same patient. Segment PID is not provided in this segment group because it is the same patient, and the laboratory is not concerned by the fact that this patient might have had a different identification when the prior results were produced.

470

Segment PV1, which is the first segment of the segment group PRIOR RESULT, is mandatory. The presence of this segment at this point in the message structure announces unambiguously a set of prior orders with related prior observations. The segment PV1 represents the patient visit (or encounter) during which these prior observations were produced. The only field mandatory in the segment PV1 is PV1-2 “Patient Class” (as shown in Volume 2x, Appendix C). If the sender of this message does not know the patient class, it SHALL value the field PV1-2 “U”, which stands for “patient class unknown”.

475

The ORC appearing in the PRIOR RESULT segment group is mandatory and SHALL have its first field “Order Control” populated with “PR” (Prior results).

480

The SAC segment should be used only to provide information specific of that segment, i.e., having no placeholder in the SPM segment.

3.1.4.1.2.2 ORL^O22 Static Definition

Table 3.1.4.1.2.2-1: ORL^O22 Message Static Definition

Segment	Meaning	Usage	Card.	HL7 chapter
MSH	Message header	R	[1..1]	2
MSA	Message Acknowledgement	R	[1..1]	2
[{ERR}]	Error	C	[0..*]	2
[--- RESPONSE begin	C	[0..1]	
[--- PATIENT begin	R	[1..1]	
[PID]	Patient Identification	O	[0..1]	3
{	--- ORDER begin	R	[1..*]	

Segment	Meaning	Usage	Card.	HL7 chapter
ORC	Common Order	R	[1..*]	4
[{	--- TIMING begin	RE	[0..1]	
TQ1	Timing/Quantity	R	[1..1]	4
}]	--- TIMING end			
	--- OBSERVATION REQUEST begin	R	[1..1]	
OBR	Observation Request	R	[1..1]	4
[{	--- SPECIMEN begin	O	[0..1]	
SPM	Specimen	R	[1..1]	7
[{SAC}]	Specimen Container Details	O	[0..*]	7
}]	--- SPECIMEN end			
	--- OBSERVATION REQUEST end			
}	--- ORDER end			
]	--- PATIENT end			
]	--- RESPONSE end			

485 MSH-9 - Message Type (MSG) shall have its three components respectively valued to “ORL”, “O22” and “ORL_O22”.

The ERR segment shall be used in case of negative acknowledgement (when MSA-1 = AE or AR).

490 The RESPONSE segment group is mandatory unless in case of error (MSA-1 = AE or AR). This segment group carries the response of the Order Filler in the segments ORC and OBR.

The mandatory ORC and OBR segments in the repeatable ORDER segment group provide the response of the Order Filler for each order, in particular the ORC-1 Order Control field, which values are listed in the table of Section 3.1.4.1.3.

3.1.4.1.2.3 OBR Segment Static Definition

495 **Table 3.1.4.1.2.3-1: OBR - Observation Request Segment**

SEQ	LE N	DT	Usage	Card.	TBL #	ITEM#	Element name
2	22	EI	R	[1..1]		00216	Placer Order Number
3	22	EI	RE	[0..1]		00217	Filler Order Number
4	250	CE	R	[1..1]		00238	Universal Service Identifier
5	2	ID	X	[0..0]		00239	Priority – OBR
6	26	TS	X	[0..0]		00240	Requested Date/Time
7	26	TS	C	[0..1]		00241	Observation Date/Time #
8	26	TS	X	[0..0]		00242	Observation End Date/Time #
9	20	CQ	X	[0..0]		00243	Collection Volume

SEQ	LE N	DT	Usage	Card.	TBL #	ITEM#	Element name
10	250	XCN	RE	[0..*]		00244	Collector Identifier
11	1	ID	RE	[0..1]	0065	00245	Specimen Action Code
12	250	CE	X	[0..0]		00246	Danger Code
13	300	ST	X	[0..0]		00247	Relevant Clinical Information
14	26	TS	X	[0..0]		00248	Specimen Received Date/Time *
15	300	SPS	X	[0..0]		00249	Specimen Source
16	250	XCN	R	[1..1]		00226	Ordering Provider
17	250	XTN	RE	[0..2]		00250	Order Callback Phone Number
18	60	ST	X	[0..0]		00251	Placer Field 1
19	60	ST	X	[0..0]		00252	Placer Field 2
20	60	ST	X	[0..0]		00253	Filler Field 1 +
21	60	ST	X	[0..0]		00254	Filler Field 2 +
22	26	TS	X	[0..0]		00255	Results Rpt/Status Chng - Date/Time +
23	40	MOC	X	[0..0]		00256	Charge to Practice +
24	10	ID	C	[0..1]	0074	00257	Diagnostic Serv Sect ID
25	1	ID	C	[0..1]	0123	00258	Result Status +
26	400	PRL	X	[0..0]		00259	Parent Result +
27	200	TQ	X	[0..0]		00221	Quantity/Timing
28	250	XCN	RE	[0..*]		00260	Result Copies To
29	200	EIP	X	[0..0]		00261	Parent
30	20	ID	X	[0..0]	0124	00262	Transportation Mode
37	4	NM	X	[0..1]		01028	Number of Sample Containers *
40	250	CE	X	[0..0]		01031	Transport Arrangement Responsibility
41	30	ID	X	[0..0]	0224	01032	Transport Arranged
42	1	ID	X	[0..0]	0225	01033	Escort Required
43	250	CE	X	[0..0]		01034	Planned Patient Transport Comment
48	250	CWE	X	[0..0]	0476	01646	Medically Necessary Duplicate Procedure Reason.

OBR-2 Placer Order Number (EI), required in transaction [LAB-1].

500

Each ordered battery/test should be assigned to a unique Order, identified by a unique Placer Order Number. The same identifier will never be used twice by the Order Placer. The Placer Order Number is generated by the Order Placer and should be unique across all OBR segments across all messages.

OBR-3 Filler Order Number (EI), required if available.

505 Each Order should be assigned a unique Filler Order Number by the Order Filler. The same identifier will never be used twice by the Order Filler. The filler order number generated by the Order Filler should be unique across all OBR segments across all messages.

OBR-4 Universal Service Identifier (CE), required.

This field contains one ordered battery or test. A battery is composed of one or more tests or batteries.

510 Additionally, when the “Report Facsimile For Order Group” Option is activated, when placing an Order Group, the Order Placer MAY request this service in an extra (ORC/OBR) segment group. In that case this requested service SHALL be identified in this field using either the LOINC code: 11502-2^ LABORATORY REPORT.TOTAL^LN or one of the LOINC codes for laboratory specialties listed in LAB TF-3: Table 2.3.4.1.1-1. For instance, the request for a microbiology report facsimile shall populate OBR-4 with: 18725-2^ MICROBIOLOGY
515 STUDIES^LN

OBR-5 Priority and OBR-6 Requested Date/Time are not supported. See TQ1 segment.

Condition predicate for OBR-7: this field is a copy of SPM-17.1. The information is provided when the placer of the order knows the time of the specimen collection.

OBR-8, OBR-12, OBR-14, OBR-15 fields are superseded by fields of the SPM segment.

520 OBR-10 Collector Identifier, required if available.

This repeatable field identifies the person who collected the specimen(s).

OBR-11 Specimen Action Code (ID), required if available.

The value of this field is dependent on the use case as described in Volume 1.

525 The field identifies the action to be taken with respect to the specimens that accompany or precede this order. The purpose of this field is to further qualify (when appropriate) the general action indicated by the order control code contained in the accompanying ORC segment.

HL7 Table 0065 - Specimen Action Code gives the valid values:

HL7 Table 0065 - Specimen Action Code

Value	Description	Comment
A	Add ordered tests to the existing specimen	
G	Generated order; reflex order	
L	Lab to obtain specimen from patient	
O	Specimen obtained by service other than Lab	
P	Pending specimen; Order sent prior to delivery	
R	Revised order	
S	Schedule the tests specified below	

530 OBR-13 Relevant Clinical information (ST), not supported.

Transaction [LAB-1] uses OBX segment to carry relevant clinical information, or a NTE segment below the OBR for more comment orientated information.

OBR-16 Ordering Provider (XCN), required.

OBR-17 Order Callback Phone Number (XTN), required if available.

535 This field contains one or two telephone numbers for reporting a status or a result using the standard format with extension and/or beeper number when applicable.

OBR-22 Results Rpt/Status Chng - Date/Time (TS), not used in [LAB-]1: OBR-22 is related to the results, not to the order. OBR-22 is related to OBR-25. ORC-9 contains the date/time of the latest status change of the ORDER.

540 OBR-24 Diagnostic Serv Sect ID (ID), conditional

Condition predicate: This field is RE for the Order Filler. The valid values are defined in HL7 Table 0074 - Diagnostic Service Section ID. The table below presents a subset of these valid values as identified in Volume 1.

HL7 Table 0074 - Diagnostic Service Section ID (subset)

Value	Description	Addressed by Laboratory TF 2003 - 2004
BG	Blood Gases	Yes
CH	Chemistry	Yes
CP	Cytopathology	
HM	Hematology	Yes
IMM	Immunology	Yes
LAB	Laboratory	Yes
MB	Microbiology	Yes
MCB	Mycobacteriology	Yes
MYC	Mycology	Yes
OSL	Outside Lab	
SR	Serology	Yes
TX	Toxicology	Yes
VR	Virology	Yes

545

OBR-25 Order Result Status (ID), Conditional.

Condition predicate: This field shall not be filled in messages sent by the Order Placer. This field shall be filled in messages sent by the Order Filler, according to HL7 Table 0123 described in Chapter 7 of HL7. The possible values for this field are a subset of this table:

550

HL7 Table 0123 - Result Status

Value	Description	Comment
O	Order received; specimen not yet received	
I	No results available; specimen received, procedure incomplete	
S	No results available; procedure scheduled, but not done	
R	Results stored; not yet verified	
P	Preliminary: A verified early result is available, final results not yet obtained	
F	Final results; results stored and verified. Can only be changed with a corrected result.	
C	Correction to results	
X	No results available. Order canceled	

Note: For the conditions of use of these values, please read Appendix C in Volume 2x: “Correlations of status between ORC, OBR and OBX”.

555 OBR-28 Result Copies To (XCN), required if available.

This field identifies the people who are to receive copies of the results. By local convention, either the ID number or the name may be absent. The Order Placer shall fill this field when it sends a new order for which there are persons or care units declared for receiving a copy of the results.

560 **3.1.4.1.3 Expected Actions**

Table 3.1.4.1.3-1: Expected Actions by Responder in [LAB-1]

Event	Initiator	Responder	Expected action by the responder
New order placed (NW)	Order Placer	Order Filler	check the order content, if accepted, assign a filler order number and store it, in wait for specimens, respond OK, otherwise respond “unable to accept” (UA)
Request for replacement of a test/battery (RP)	Order Placer	Order Filler	Check whether the action is possible, considering the work in progress on the order. If accepted respond “replaced as requested (RQ) otherwise respond “unable to “replace” (UM)
Request for cancellation of an order (CA)	Order Placer	Order Filler	Check whether the action is possible, considering the work in progress on the order. If accepted respond “canceled as requested (CR) otherwise respond “unable to “cancel” (UC)
Unsolicited replacement of a test/battery (RU)	Order Filler	Order Placer	Update the content of the order, and acknowledge (OK), keep the ordering provider informed of this order content change.

Event	Initiator	Responder	Expected action by the responder
Unsolicited cancellation of a test/battery (OC)	Order Filler	Order Placer	Update the content of the order, and acknowledge (OK), keep the ordering provider informed of this order cancellation.
Status change of an order (SC)	Order Filler	Order Placer	Update the status of the order, and acknowledge (OK), keep the ordering provider informed of the advancement of work on this order.

3.1.4.2 Message OML^O33 and its Acknowledgement ORL^O34

565 This specimen centric message pair contains a list of specimens. Each specimen may be associated with a list of containers, and is associated with a list of ordered batteries/tests (belonging to zero or one Order Group) to be performed on this specimen. This structure is particularly appropriate for ordering multiple batteries/tests on a specimen (e.g., in chemistry or microbiology).

3.1.4.2.1 Trigger Events

The real events conveyed by ORC-1 are listed in Section 3.1.3.2.

570 3.1.4.2.2 Message Semantics

3.1.4.2.2.1 OML^O33 Static Definition

Table 3.1.4.2.2.1-1: OML^O33 Message Static Definition

Segment	Meaning	Usage	Card.	HL7
MSH	Message Header	R	[1..1]	2
[--- PATIENT begin	RE	[0..1]	
PID	Patient Identification	R	[1..1]	3
[--- PATIENT_VISIT begin	RE	[0..1]	
PV1	Patient Visit	R	[1..1]	3
]	--- PATIENT_VISIT end	RE	[0..1]	
]	--- PATIENT end			
{	--- SPECIMEN begin	R	[1..*]	
SPM	Specimen	R	[1..*]	7
[{SAC}]	Specimen Container	RE	[0..*]	13
{	--- ORDER begin	R	[1..*]	
ORC	Common Order (for one battery)	R	[1..*]	4
[--- TIMING begin	RE	[0..1]	
TQ1	Timing Quantity	R	[1..1]	4
]	--- TIMING end	RE	[0..1]	
	--- OBSERVATION REQUEST begin	R	[1..1]	
OBR	Observation Request	R	[1..1]	4

Segment	Meaning	Usage	Card.	HL7
{ {	--- OBSERVATION begin	O	[0..*]	
OBX	Observation Result	R	[1..1]	7
[{NTE}]	Notes and comments for result	C	[0..1]	
}}	--- OBSERVATION end			
{ {	--- PRIOR RESULT begin	O	[0..*]	
PV1	Patient Visit – previous result	R	[1..1]	3
{	--- ORDER PRIOR begin	R	[1*]	
ORC	Common order – previous result	R	[1..1]	4
OBR	Order detail – previous result	R	[1..1]	4
{	--- OBSERVATION PRIOR begin	R	[1..*]	
OBX	Observation/Result – previous result	R	[1..1]	
[{NTE}]	Comment of the result	O	[0..*]	2
}	--- OBSERVATION PRIOR end			
}	--- ORDER PRIOR end			
}}	--- PRIOR RESULT end			
	--- OBSERVATION REQUEST end			
}	--- ORDER end			
}	--- SPECIMEN end			

575 MSH-9 - Message Type (MSG) shall have its three components respectively valued to “OML”, “O33”, and “OML_O33”.

The conditions on the OBSERVATION segment group are the same as for OML^O21.

580 The SAC segment should be used only to provide information specific of that segment, i.e., having no placeholder in the SPM segment. The PRIOR RESULT segment group provides the prior results obtained for the same patient. Segment PID is not provided in this segment group because it is the same patient, and the laboratory is not concerned by the fact that this patient might have had a different identification when the prior results were produced.

585 Segment PV1, which is the first segment of the segment group PRIOR RESULT, is mandatory. The presence of this segment at this point in the message structure announces unambiguously a set of prior orders with related prior observations. The segment PV1 represents the patient visit (or encounter) during which these prior observations were produced. The only field mandatory in the segment PV1 is PV1-2 “Patient Class” (as shown in Volume 2x, Appendix C). If the sender of this message does not know the patient class, it SHALL value the field PV1-2 “U”, which stands for “patient class unknown”.

590 The ORC appearing in the PRIOR RESULT segment group is mandatory and SHALL have its first field “Order Control” populated with “PR” (Prior results).

3.1.4.2.2.2 ORL^O34 Static Definition

Table 3.1.4.2.2.2-1: ORL^O34 Message Static Definition

Segment	Meaning	Usage	Card.	HL7 chapter
MSH	Message header	R	[1..1]	2
MSA	Message Acknowledgement	R	[1..1]	2
[{ERR}]	Error	O	[0..*]	2
[--- RESPONSE begin	C	[0..1]	
[--- PATIENT begin	R	[1..1]	
[PID]	Patient Identification	O	[0..1]	3
{	--- SPECIMEN begin	R	[1..*]	
SPM	Specimen	R	[1..1]	7
[{SAC}]	Specimen Container	O	[0..*]	13
{	--- ORDER begin	R	[1..*]	
ORC	Common Order	R	[1..1]	4
[{	--- TIMING begin	RE	[0..1]	
TQ1	Timing/Quantity	R	[1..1]	4
}]	--- TIMING end	RE	[0..1]	
OBR	Observation Request	R	[1..1]	4
}	--- ORDER end			
}	--- SPECIMEN end			
]	--- PATIENT end			
]	--- RESPONSE end			

595 MSH-9 - Message Type (MSG) shall have its three components respectively valued to “ORL”, “O34” and “ORL_O34”.

The RESPONSE segment group is mandatory unless in case of error (MSA-1 = AE or AR). This segment group carries the response of the Order Filler in the segments ORC and OBR.

600 The mandatory ORC and OBR segments in the repeatable ORDER segment group provide the response of the Order Filler for each order, in particular the ORC-1 Order Control field, which values are listed in the table of Section 3.1.4.1.3.

3.1.4.2.2.3 OBR Segment Static Definition

See Section 3.1.4.1.2.3.

3.1.4.2.3 Expected Actions

Identical to Section 3.1.4.1.3

605 **3.1.4.3 Message OML^O35 and its Acknowledgement ORL^O36**

This message pair contains a list of specimens. Each specimen may be associated with one or more containers. Each container is associated with a list of ordered batteries/tests (belonging to zero or one Order Group) to be performed on the specimen in this container.

3.1.4.3.1 Trigger Events

610 The real events conveyed by ORC-1 are listed in Section 3.1.3.2.

3.1.4.3.2 Message Semantics

3.1.4.3.2.1 OML^O35 Static Definition

Table 3.1.4.3.2.1-1: OML^O35 Message Static Definition

Segment	Meaning	Usage	Card	HL7
MSH	Message Header	R	[1..1]	2
[--- PATIENT begin	RE	[0..1]	
PID	Patient Identification	R	[1..1]	3
[--- PATIENT_VISIT begin		[0..1]	
PV1	Patient Visit	R	[1..1]	3
]	--- PATIENT_VISIT end			
]	--- PATIENT end			
{	--- SPECIMEN begin	R	[1..*]	
SPM	Specimen	R	[1..1]	7
{	--- CONTAINER begin	R	[1..*]	
SAC	Container detail	R	[1..1]	13
{	--- ORDER begin	R	[1..*]	
ORC	Common Order (for one battery)	R	[1..1]	4
[{	--- TIMING begin	RE	[0..1]	
TQ1	Timing Quantity	R	[1..1]	4
}]	--- TIMING end			
	--- OBSERVATION REQUEST begin	R	[1..1]	
OBR	Observation Request	R	[1..1]	4
[{	--- OBSERVATION begin	O	[0..*]	
OBX	Observation Result	R	[1..*]	7
[{NTE}]	Comment of the result	C	[0..*]	2
}]	--- OBSERVATION end			
[{	--- PRIOR_RESULT begin	O	[0..*]	
PV1	Patient Visit – previous result	R	[1..1]	3
{	--- ORDER_PRIOR begin	R	[1..*]	
ORC	Common Order - previous result	R	[1..1]	4

Segment	Meaning	Usage	Card	HL7
OBR	Order Detail - previous result	R	[1..1]	4
{ [NTE] }	Notes and Comments - previous result	O	[0..*]	2
{	--- OBSERVATION_PRIOR begin	R	[1..*]	
OBX	Observation/Result - previous result	R	[1..1]	7
{ [NTE] }	Notes and Comments - previous result	O	[0..*]	2
}	--- OBSERVATION_PRIOR end			
}	--- ORDER_PRIOR end			
}]	--- PRIOR_RESULT end			
	--- OBSERVATION REQUEST end			
}	--- ORDER end			
}	--- CONTAINER end			
}	--- SPECIMEN end			

615 Field MSH-9 - Message Type (MSG) shall have its three components respectively valued to “OML”, “O35” and “OML_O35”.

The conditions on the OBSERVATION segment group are the same as for message OML^O21.

The SAC segment below the SPM segment is mandatory in OML^O35 message structure.

The PRIOR RESULT segment group provides the prior results obtained for the same patient.

620 Segment PID is not provided in this segment group because it is the same patient, and the laboratory is not concerned by the fact that this patient might have had a different identification when the prior results were produced.

Segment PV1, which is the first segment of the segment group PRIOR RESULT, is mandatory.

625 The presence of this segment at this point in the message structure announces unambiguously a set of prior orders with related prior observations. The segment PV1 represents the patient visit (or encounter) during which these prior observations were produced. The only field mandatory in the segment PV1 is PV1-2 “Patient Class” (as shown in Volume 2x, Appendix C). If the sender of this message does not know the patient class, it SHALL value the field PV1-2 “U”, which stands for “patient class unknown”.

630 The ORC appearing in the PRIOR RESULT segment group is mandatory and SHALL have its first field “Order Control” populated with “PR” (Prior results).

3.1.4.3.2.2 ORL^O36 Static Definition

Table 3.1.4.3.2.2-1: ORL^O36 Message Static Definition

Segment	Meaning	Usage	Card.	HL7
MSH	Message header	R	[1..1]	2
MSA	Message Acknowledgement	R	[1..1]	2

Segment	Meaning	Usage	Card.	HL7
[{ERR}]	Error	C	[0..*]	2
[--- RESPONSE begin	C	[0..1]	
[--- PATIENT begin	R	[1..1]	
PID	Patient Identification	O	[0..1]	3
{	--- SPECIMEN begin			
SPM	Specimen	R	[1..*]	7
{	--- CONTAINER begin	R	[1..*]	
SAC	Specimen Container	R	[1..1]	13
{	--- ORDER begin	R	[1..*]	
ORC	Common Order	R	[1..*]	4
[{	--- TIMING begin	RE	[0..1]	
TQ1	Timing/Quantity	R	[1..1]	4
}]	--- TIMING end			
OBR	Observation Request	R	[1..1]	4
}	--- ORDER end			
}	--- CONTAINER end			
}	--- SPECIMEN end			
]	--- PATIENT end			
]	--- RESPONSE end			

635 MSH-9 - Message Type (MSG) shall have its three components respectively valued to “ORL”, “O36” and “ORL_O36”.

The RESPONSE segment group is mandatory unless in case of error (MSA-1 = AE or AR). This segment group carries the response of the Order Filler in the segments ORC and OBR.

640 The mandatory ORC and OBR segments in the repeatable ORDER segment group provide the response of the Order Filler for each order, in particular the ORC-1 Order Control field, which values are listed in the table of Section 3.1.4.1.3.

3.1.4.3.2.3 OBR Segment Static Definition

See Section 3.1.4.1.2.3.

3.1.4.3.3 Expected Actions

645 Identical to Section 3.1.4.1.3.

3.1.5 Security Considerations

The only security constraint is that both Order Result Tracker and Order Filler be grouped with a Consistent Time Client, as specified in PaLM TF-1, and that these two CT Clients be served by a common Consistent Time Server.

650 **3.2 Filler Order Management [LAB-2]**

3.2.1 Scope

655 This transaction is used by the Order Filler to inform the Order Placer that a new Order, standalone or embedded in an existing Order Group, has been generated on the laboratory side. By this transaction, the Order Filler requests the Order Placer to assign a unique Placer Order Number to this new Order. The Order contains a battery or a test to be performed by the laboratory, using biological specimens collected from the subject.

3.2.2 Actor Roles

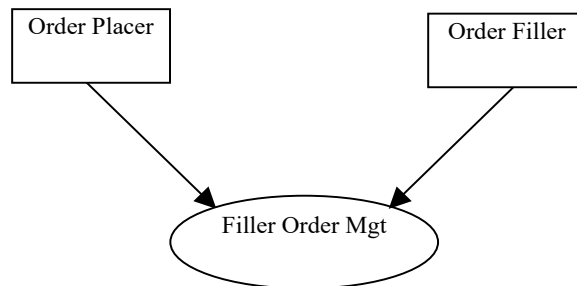

Figure 3.2.2-1: Use Case Diagram

660

Table 3.2.2-1: Actor Roles

Actor:	Order Placer
Role:	Receives filler orders. Notifies the Order Filler of acceptance with a placer number assigned, or refusal.
Actor:	Order Filler
Role:	Notifies filler orders to the Order Placer. Receives acceptance with a placer number assigned, or rejection.

3.2.3 Referenced Standards

HL7 version 2.5.1:

- Chapter 2: "Control" --> generic segments and data types
- Chapter 3: "ADT" --> PID and PV1 segments
- 665 • Chapter 4: "Order Entry" --> OML and ORL messages
- Chapter 7: "Observation Reporting" --> SPM segment

- Chapter 13: "Clinical Laboratory Automation" --> SAC segment

3.2.3.1 HL7 2.5 OML Message Structures

Identical to those listed in Section 3.1.3.1.

670 3.2.4 Interaction Diagram

In all interactions below, the initiator chooses the OML message structure appropriate to its orders. The responder SHALL respond with the corresponding ORL message structure. An OML message shall be responded to with exactly one ORL message.

675 The figure below shows the flow of messages in the normal process of a filler order. A filler order is placed, and responded to by either a rejection or an acceptance and a placer number assigned to it.

The creation of a filler order may be triggered by a prior placer order, e.g., if the results of one of the previously ordered tests triggers the laboratory to perform additional tests. The creation of a filler order could also happen during the quality control performed by the laboratory on a new order received from the Order Placer: the laboratory may then decide that some extra battery that
680 was not ordered should be added, e.g., regarding the pathology context.

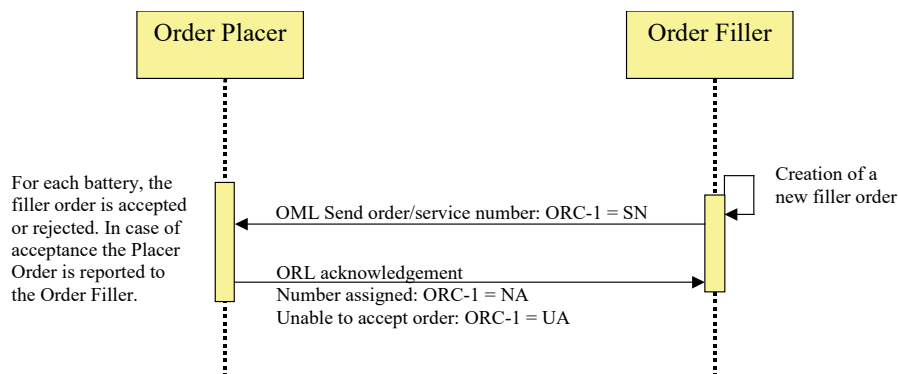

Figure 3.2.4-1: Process of a filler order

685 3.2.4.1 Message OML^O21 and its Acknowledgement ORL^O22

Battery/test centric message pair.

3.2.4.1.1 Trigger Events

The real event is the creation of a filler order and the request of a placer number for it.

3.2.4.1.2 Message Semantics

690 3.2.4.1.2.1 OML^O21 Static Definition

See Section 3.1.4.1.2.1.

3.2.4.1.2.2 ORL^O22 Static Definition

See Section 3.1.4.1.2.2.

3.2.4.1.2.3 OBR Segment Static Definition

695

Table 3.2.4.1.2.3-1: OBR - Observation Request Segment

SEQ	LEN	DT	Usage	Card.	TBL#	ITEM#	Element name
2	22	EI	C	[0..1]		00216	Placer Order Number
3	22	EI	R	[1..1]		00217	Filler Order Number
4	250	CE	R	[1..1]		00238	Universal Service Identifier
5	2	ID	X	[0..0]		00239	Priority – OBR
6	26	TS	X	[0..0]		00240	Requested Date/Time
7	26	TS	C	[0..1]		00241	Observation Date/Time #
8	26	TS	X	[0..0]		00242	Observation End Date/Time #
9	20	CQ	X	[0..0]		00243	Collection Volume
10	250	XCN	RE	[0..*]		00244	Collector Identifier
11	1	ID	RE	[0..1]	0065	00245	Specimen Action Code
12	250	CE	X	[0..0]		00246	Danger Code
13	300	ST	X	[0..0]		00247	Relevant Clinical Information
14	26	TS	X	[0..0]		00248	Specimen Received Date/Time *
15	300	SPS	X	[0..0]		00249	Specimen Source
16	250	XCN	RE	[0..1]		00226	Ordering Provider
17	250	XTN	RE	[0..2]		00250	Order Callback Phone Number
18	60	ST	X	[0..0]		00251	Placer Field 1
19	60	ST	X	[0..0]		00252	Placer Field 2
20	60	ST	X	[0..0]		00253	Filler Field 1 +
21	60	ST	X	[0..0]		00254	Filler Field 2 +
22	26	TS	X	[0..0]		00255	Results Rpt/Status Chng - Date/Time +
23	40	MOC	X	[0..0]		00256	Charge to Practice +
24	10	ID	RE	[0..1]	0074	00257	Diagnostic Serv Sect ID
25	1	ID	X	[0..0]	0123	00258	Result Status +
26	400	PRL	X	[0..0]		00259	Parent Result +
27	200	TQ	X	[0..0]		00221	Quantity/Timing
28	250	XCN	RE	[0..*]		00260	Result Copies To

SEQ	LEN	DT	Usage	Card.	TBL#	ITEM#	Element name
29	200	EIP	X	[0..0]		00261	Parent
30	20	ID	X	[0..0]	0124	00262	Transportation Mode
37	4	NM	X	[0..1]		01028	Number of Sample Containers *
40	250	CE	X	[0..0]		01031	Transport Arrangement Responsibility
41	30	ID	X	[0..0]	0224	01032	Transport Arranged
42	1	ID	X	[0..0]	0225	01033	Escort Required
43	250	CE	X	[0..0]		01034	Planned Patient Transport Comment
48	250	CWE	X	[0..0]	0476	01646	Medically Necessary Duplicate Procedure Reason.

OBR-2 Placer Order Number (EI), conditional.

Condition predicate: Populated only in the ORL message sent back by the Order Placer to acknowledge an accepted filler order. In that case ORC-1 = “NA” (number assigned).

700 OBR-3 Filler Order Number (EI), required.

The filler order number should be unique across all OBR segments across all messages ever sent by the order filler.

OBR-4 Universal Service Identifier (CE), required

705 This field contains one ordered battery or test. A battery is composed of one or more tests or batteries.

OBR-5 Priority and OBR-6 Requested Date/Time

These two fields are not supported. See TQ1 segment.

Condition predicate for OBR-7: this field is a copy of SPM-17.1. The information is provided when the placer of the order knows the time of the specimen collection.

710 OBR-8, OBR-12, OBR-14, OBR-15 fields are superseded by fields of the SPM segment.

OBR-10 Collector Identifier, required if available.

This repeatable field identifies the person who collected the specimen(s).

OBR-11 Specimen Action Code (ID), required if available.

The value of this field is dependent on the use case as described in Volume 1.

715 The field identifies the action to be taken with respect to the specimens that accompany or precede this order. The purpose of this field is to further qualify (when appropriate) the general action indicated by the order control code contained in the accompanying ORC segment.

HL7 Table 0065 - Specimen Action Code gives the valid values:

HL7 Table 0065 - Specimen Action Code

Value	Description	Comment
G	Generated order; filler order	

720

OBR-13 Relevant Clinical information (ST), not supported.

Instead of OBR-13, transaction [LAB-2] uses OBX segment to carry relevant clinical information, or a NTE segment below the OBR for more comment orientated information.

OBR-16 Ordering Provider (XCN), required if available.

725 OBR-17 Order Callback Phone Number (XTN), required if available. One or two phone numbers.

OBR-24 Diagnostic Serv Sect ID (ID), required if available.

The valid values are defined in HL7 Table 0074 - Diagnostic Service Section ID. The table below presents a subset of these valid values as identified in Volume 1.

730

HL7 Table 0074 - Diagnostic Service Section ID (subset)

Value	Description	Addressed by Laboratory TF 2003 - 2004
BG	Blood Gases	Yes
CH	Chemistry	Yes
CP	Cytopathology	
HM	Hematology	Yes
IMM	Immunology	Yes
LAB	Laboratory	Yes
MB	Microbiology	Yes
MCB	Mycobacteriology	Yes
MYC	Mycology	Yes
OSL	Outside Lab	
SR	Serology	Yes
TX	Toxicology	Yes
VR	Virology	Yes

OBR-28 Result Copies To (XCN), required if available.

HL7 Definition: This field identifies the persons who are to receive copies of the results. By local convention, either the ID number or the name may be absent.

735 If there are known individuals or care units that should receive a copy of results related to this order, they should be listed here.

3.2.4.1.3 Expected Actions

Table 3.2.4.1.3-1: Expected Actions by Responder in [LAB-2]

Event	Initiator	Responder	Expected action by the responder
Request a placer number for a filler order	Order Filler	Order Placer	check the order content, if accepted, assign a placer order number, store it, and send it in the response “number assigned” (NA), otherwise respond “unable to accept” (UA)

3.2.4.2 Message OML^O33 and its Acknowledgement ORL^O34

740 Specimen centric message pair.

3.2.4.2.1 Trigger Events

The real event is the creation of a filler order and the request of a placer number for it.

3.2.4.2.2 Message Semantics

3.2.4.2.2.1 OML^O33 Static Definition

745 See Section 3.1.4.2.2.1.

3.2.4.2.2.2 ORL^O34 Static Definition

See Section 3.1.4.2.2.2.

3.2.4.2.2.3 OBR Segment Static Definition

See Section 3.2.4.1.2.3

750 3.2.4.2.3 Expected Actions

See Section 3.2.4.1.3

3.2.4.3 Message OML^O35 and its Acknowledgement ORL^O36

Specimen/container centric message pair.

3.2.4.3.1 Trigger Events

755 The real event is the creation of a filler order and the request of a placer number for it.

3.2.4.3.2 Message Semantics

3.2.4.3.2.1 OML^O35 Static Definition

See Section 3.1.4.3.2.1.

3.2.4.3.2.2 ORL^O36 Static Definition

760 See Section 3.1.4.3.2.2.

3.2.4.3.2.3 OBR Segment Static Definition

See Section 3.2.4.1.2.3

3.2.4.3.3 Expected Actions

See Section 3.2.4.1.3

765 3.2.5 Security Consideration

The only security constraint is that both Order Result Tracker and Order Filler be grouped with a Consistent Time Client, as specified in PaLM TF-1, and that these two CT Clients be served by a common Consistent Time Server.

770 **3.3 Order Results Management [LAB-3]**

3.3.1 Scope

775 This transaction notifies the Order Result Tracker of requested tests upon creation of an order or reception of a specimen in the laboratory. It transmits the observation results from the Order Filler to the Order Result Tracker, when a result is acquired, clinically validated, modified or deleted at the Order Filler level. Another goal of this transaction is to provide the Order Result Tracker with the complete sorted set of results related to an Order Group or to an Order. The Order Result Tracker shall store these results in the sorting order given by the Order Filler. In addition, if the “Report Facsimile For Order Group” Option is activated, this transaction MAY provide in the results messages related to an Order Group a PDF report built by the OF presenting the releasable results of this Order Group.

780

In order to maintain consistency between order and result messages, the result messages of transaction [LAB-3] should refer to primary specimen even in the case where some of the observations are performed on secondary samples that are derived from primary specimen after specific preparation.

785 **3.3.2 Actor Roles**

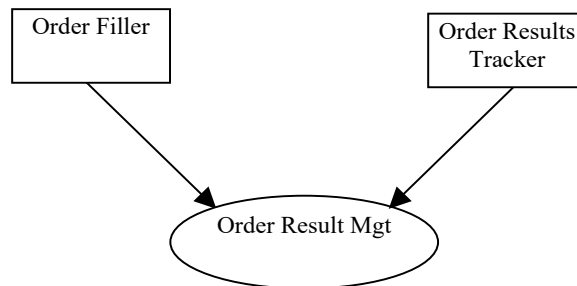

Figure 3.3.2-1: Use Case Diagram

Table 3.3.2-1: Actor Roles

Actor:	Order Filler
Role:	<p>Sends notification to the Order Result Tracker for specimen arrival, acquisition of technically validated results, clinical validation of results, modification/cancellation of results and deletion of tests.</p> <p>Provides the complete sorted set of results related to an Order Group or to an order.</p> <p>In case the “Report Facsimile For Order Group” Option is in use, upon request from the OP the OF complements its results messages related to an Order Group and carrying some clinically validated results, with a link to the PDF report recapitulating the set of clinically validated results completed for this Order Group.</p>

Actor:	Order Result Tracker
Role:	<p>Receives results for orders from the Order Filler, gives access to these orders and results to the healthcare enterprise, respects the sorting order of the results as received from the Order Filler.</p> <p>In case the “Report Facsimile For Order Group” Option is in use, when receiving a result message related to an Order Group providing a link to the PDF report, the ORT imports this PDF file immediately, and integrates it with the set of results received.</p>

790 **3.3.3 Referenced Standards**

HL7 version 2.5.1:

- Chapter 2: "Control" --> generic segments and data types
- Chapter 3: "ADT" --> PID and PV1 segments
- Chapter 4: "Order Entry" --> OML and ORL messages
- Chapter 7: "Observation Reporting" --> SPM segment

795

3.3.3.1 HL7 2.5 Result Message Structures

Transaction [LAB-3] admits two message structures from the base standard:

- The OUL^R22 message is designed for specimen centered result reporting.
- The ORU^R01 message is designed for order centered result reporting.

800 **3.3.3.2 Constraints on Result Message Structures added by Transaction [LAB-3]**

In both message structures listed above, the order in which the OBX segments appear defines the sorting order for the presentation of the results for a given battery or specimen. In this respect, the Order Filler shall transmit all available results for the battery or specimen in recapitulative mode no matter whether they have already been transmitted or not.

805 An Order Filler MAY send whichever message structure depending upon its own business rules. An Order Result Tracker SHALL be able to receive both message structures.

3.3.4 Interaction Diagram

810 The figures below show the flow of messages that occurs during normal process of a filler order, from the reception of specimen or entry of the order in the laboratory, up to the completion of this order and visualization of results by an end user on the Order Result Tracker. For each triggering event of an OUL or ORU message, the value of the result status of the OBR (OBR-25) is indicated.

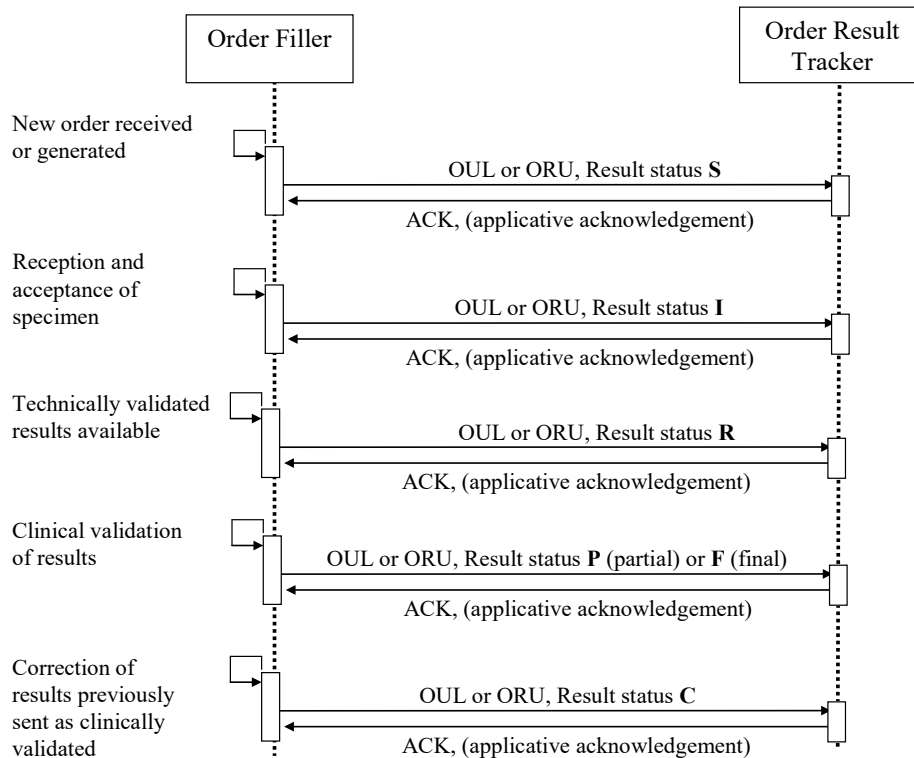

815 **Figure 3.3.4-1: Normal process for management of results of a filler order**

The first interaction appearing in this diagram is triggered by the accession of the order or of the Order Group by the Order Filler application. The Order Result Status (OBR-25) is valued:

- "S" (Scheduled) if the specimen is not received or collected yet.
- "I" if the specimen is available in lab.

820 In this first message, the date/time of transaction for the Order (ORC-9) is a good approximation of the date/time of accession of the Order by the Order Filler application. For an Order Group identified by ORC-4 and comprising several orders, the minimum value of all ORC-9 in the corresponding ORC segments is the approximation of the date/time of accession of the Order Group by the Order Filler application.

825 The decision whether to deliver or not technically validated results (using OBR-25 "Result Status" "R") to the Order Result Tracker is driven by organization rules specific to each healthcare enterprise. These rules may take account of the order priority (TQ1-9), the ordering provider, the particular ordered battery, the executing laboratory, the observation result itself...

830 This Technical Framework does not make any assertion on these rules. It only states that an Order Filler MUST be able to send all the result statuses mentioned in the above diagram, and doing so, MUST conform to the correlation diagrams and transition diagrams presented in of PaLM TF-2x: Appendix C.

The same remark applies to the sending of partial clinically validated results (using OBR-25 “Result Status” “P”).

835 At any time during the process, an ordered test/battery of the order can be deleted from the filler order by the laboratory, which should trigger a message to the Order Result Tracker, with OBR-25 “Result Status” set to “X” for this particular Order, as shown below.

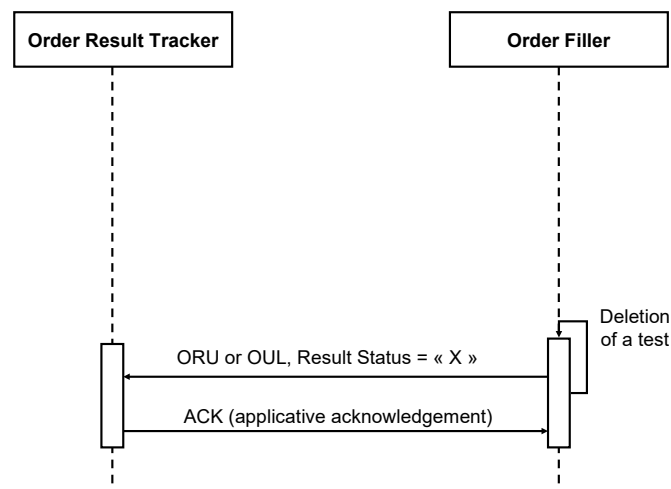

Figure 3.3.4-2: Deletion of a test by the Order Filler

840 3.3.4.1 Message OUL^R22

Preferred message structure for specimen centered result reporting.

3.3.4.1.1 Trigger Events

The following events detected by the Order Filler application (LIS) trigger the sending of an OUL or of an ORU message to the Order Result Tracker:

- 845
- Entry of an order at the laboratory level for an already collected specimen
 - Reception and acceptance of a specimen for an existing order
 - Acquisition of some technically validated results, in the context where transmission of such results is expected by the ward staff.
 - Clinical validation of results
- 850
- Correction of results previously transmitted
 - Cancellation of results previously transmitted

- Deletion of tests

3.3.4.1.2 Message Semantics

3.3.4.1.2.1 OUL^R22 Static Definition

855

Table 3.3.4.1.2.1-1: OUL^R22 static definition

Segment	Meaning	Usage	Card.	HL7 chapter
MSH	Message Header	R	[1..1]	2
[--- PATIENT begin	RE	[0..1]	
PID	Patient Identification	R	[1..1]	3
[--- VISIT begin	RE	[0..1]	
PV1	Patient Visit	R	[1..1]	3
]	--- VISIT end			
]	--- PATIENT end			
{	--- SPECIMEN begin	R	[1..*]	
SPM	Specimen	R	[1..1]	7
[{OBX}]	Observation related to specimen	O	[0..*]	
[{SAC}]	Container information	O	[0..*]	13
{	--- ORDER begin	R	[1..*]	
OBR	Observation Request	R	[1..*]	4
ORC	Common Order (for one specimen)	R	[1..1]	4
[{NTE}]	Comments on the order	O	[0..*]	2
[--- TIMING begin	RE	[0..1]	
TQ1	Timing Quantity	R	[1..1]	4
]	--- TIMING end			
[{	--- RESULT begin	O	[0..*]	
OBX	Observation related to OBR	R	[1..*]	7
[{NTE}]	Comment of the result	C	[0..*]	2
}]	--- RESULT end			
}	--- ORDER end			
}	--- SPECIMEN end			

Field MSH-9 – Message Type shall have its three components valued as follows:
OUL^R22^OUL_R22

860 For specimen oriented observation message, additional parameters that are related to the specimen (e.g., Anatomic origin, Collection procedure) should be transmitted in OBX segments that immediately follow the SPM segment.

For each set of observations (e.g., Microscopy; Culture; Antibiotic Susceptibility) the Order Filler should generate an OBR segment that identifies the Observation followed by a series of OBX segments, each of them carrying the result of an individual test/observation.

865 Following the SPM segment, the Order Filler should systematically transmit in the OUL message, all OBR and OBX segments related to this SPM. This systematic transmission of all observations linked to an SPM segment and their respective status may help the Order Result Tracker to recover from an error situation, when for some hazardous reasons a previous OUL message for the same request could not have been properly processed. For the same reason the
870 "U" value should not be used in the Observation Result Status field of an OBX segment (see description of this segment in Appendix C of Volume 2x.

In case an observation previously transmitted is deleted, the Order Filler should transmit all OBX segments linked to the OBR to which the deleted observation relates to; and it should indicate the current status of each OBX segment. The Observation Result Status field of the OBX that
875 correspond to the deleted observation should be valued with a "D".

Unless the Report Status field (OBR-25) of the OBR is valued with an "X" (deleted battery), the OBR segment shall always be followed by one or several OBX segments.

TQ1 and ORC segments shall be transmitted because they contain important information such as the priority of the order and the order group number.

880 3.3.4.1.2.2 OBR Segment Static Definition

Table 3.3.4.1.2.2-1: OBR - Observation Request Segment

SEQ	LEN	DT	Usage	Card.	TBL#	ITEM#	Element name
2	22	EI	RE	[0..1]		00216	Placer Order Number
3	22	EI	R	[1..1]		00217	Filler Order Number
4	250	CE	R	[1..1]		00238	Universal Service Identifier
5	2	ID	X	[0..0]		00239	Priority – OBR
6	26	TS	X	[0..0]		00240	Requested Date/Time
7	26	TS	C	[0..1]		00241	Observation Date/Time
8	26	TS	X	[0..0]		00242	Observation End Date/Time
9	20	CQ	X	[0..0]		00243	Collection Volume
10	250	XCN	RE	[0..*]		00244	Collector Identifier
11	1	ID	RE	[0..1]	0065	00245	Specimen Action Code
12	250	CE	X	[0..0]		00246	Danger Code
13	300	ST	X	[0..0]		00247	Relevant Clinical Information
14	26	TS	X	[0..0]		00248	Specimen Received Date/Time
15	300	SPS	X	[0..0]		00249	Specimen Source or Segment SPM
16	250	XCN	RE	[0..1]		00226	Ordering Provider
17	250	XTN	X	[0..0]		00250	Order Callback Phone Number
18	60	ST	X	[0..0]		00251	Placer Field 1

IHE Pathology & Laboratory Medicine Technical Framework, Vol. 2a (PaLM TF-2a):
Transactions

SEQ	LEN	DT	Usage	Card.	TBL#	ITEM#	Element name
19	60	ST	X	[0..0]		00252	Placer Field 2
20	60	ST	X	[0..0]		00253	Filler Field 1
21	60	ST	X	[0..0]		00254	Filler Field 2
22	26	TS	X	[0..0]		00255	Results Rpt/Status Chng – Date/Time
23	40	MOC	X	[0..0]		00256	Charge to Practice
24	10	ID	RE	[0..1]	0074	00257	Diagnostic Serv Sect ID
25	1	ID	R	[1..1]	0123	00258	Order Result Status
26	400	PRL	C	[0..1]		00259	Parent Result
27	200	TQ	X	[0..0]		00221	Quantity/Timing
28	250	XCN	RE	[0..*]		00260	Result Copies To
29	200	EIP	C	[0..1]		00261	Parent
30	20	ID	X	[0..0]	0124	00262	Transportation Mode
31	250	CE	X	[0..0]		00263	Reason for Study
32	200	NDL	C	[0..1]		00264	Principal Result Interpreter
33	200	NDL	X	[0..0]		00265	Assistant Result Interpreter
34	200	NDL	X	[0..0]		00266	Technician
35	200	NDL	O	[0..1]		00267	Transcriptionist +
36	26	TS	O	[0..1]		00268	Scheduled Date/Time +
37	4	NM	X	[0..0]		01028	Number of Sample Containers *
38	250	CE	X	[0..0]		01029	Transport Logistics of Collected Sample
39	250	CE	X	[0..0]		01030	Collector's Comment *
40	250	CE	X	[0..0]		01031	Transport Arrangement Responsibility
41	30	ID	X	[0..0]	0224	01032	Transport Arranged
42	1	ID	X	[0..0]	0225	01033	Escort Required
43	250	CE	X	[0..0]		01034	Planned Patient Transport Comment
44	250	CE	X	[0..0]	0088	00393	Procedure Code
45	250	CE	X	[0..0]	0340	01316	Procedure Code Modifier
46	250	CE	X	[0..0]	0411	01474	Placer Supplemental Service Information
47	250	CE	X	[0..0]	0411	01475	Filler Supplemental Service Information
48	250	CWE	X	[0..0]	0476	01646	Medically Necessary Duplicate Procedure Reason.
49	2	IS	X	[0..0]	N	01647	Result Handling

OBR-2 Placer Order Number (EI), required if available

OBR-3 Filler Order Number (EI), required

885 This field is required. It allows the Order Result Tracker to link all the Tests/results of a request together. It also identifies the order at the Order Filler level.

OBR-4 Universal Service Identifier (CE), required

The first three sub-fields “Identifier”, “Text” and “Name of Coding System” are required.

890 The second sub-field “Text” allows the Order Result Tracker to manage the results without the help of Battery Master File.

The last three sub-fields are optional.

OBR-7 Observation Date/Time (TS), conditional

895 Condition predicate: If the order is related to one single specimen, then OBR-7 SHALL be populated with the content of SPM-17.1, which represents the physiologically relevant date-time (i.e., the time the specimen was collected from the patient). In all other situations this field OBR-7 SHALL be populated with a NULL value: ""

OBR-9 Collection Volume (CQ)

900 Since when it is needed by the laboratory and reported, the volume of collection is the result of an observation (sometimes done by the Order Placer) that can be used for calculation of other results (e.g., Creatinine Clearance); this information should be transferred in an OBX segment as all other results of observation. This field OBR-9 should consequently not be used in this transaction.

OBR-10 Collector Identifier (XCN)

This repeatable field identifies the person who collected the specimen(s).

905 OBR-11 Specimen Action Code (ID)

This field is only required in the following events:

- The order is entered at the Order Filler side. The value of the Action Code is A in this case.
 - The battery or test has been added by the Order Filler for confirmation of a diagnostic (reflex testing); value is G in this case.
- 910

In all other triggering events of this transaction, this Action Code field is meaningless.

OBR-12 Danger Code (CE)

This field should not be used in this Technical Framework.

OBR-13 Relevant Clinical Information (ST)

915 Since it is stated in the HL7 V2.5 Chapter 7 that "for some orders this information may be sent on a more structured form as a series of OBX segments (see HL7 V2.5 Chapter 7) that

immediately follow the order segment", it is preferable and more consistent to systematically use OBX segments in the result message for sending Clinical Information.

OBR-14 Specimen Received Date/Time (TS)

920 This field should not be used; this information should be transmitted in an SPM segment.

OBR-15 Specimen Source (SPS)

As for OBR-13, if this information needs to be transmitted to the Order Result Tracker it is more consistent to transfer it in an OBX segment. This field should not be used.

OBR-16 Ordering Provider (XCN)

925 This field is required if it was part of the order sent by the Order Placer.

OBR-24 Diagnostic Serv Sect ID (ID)

This field is required if available. In case the Order Result Tracker receives part of the results of an entire order at different time, the Order Result Tracker can use this field for presenting all the batteries/test with the same Diagnostic Serv. Sect. ID together.

930 OBR-25 Result Status (ID)

This field is required and should be filled according to HL7 Table 0123 described in Chapter 4. Depending on the triggering event of the OUL or ORU message the possible values for this field are:

- 935 • Value I is used to indicate reception of specimen(s) at the laboratory. In case a battery or test requires more than one specimen (e.g., creatinine clearance) this I status has to be used when all the required specimens have been received. An OBR segment with this I status may be followed by OBX segments that contains result of observations performed at specimen collection time (e.g., volume of collected specimen).
- 940 • Value R, to indicate that some results are available and technically validated but not yet clinically validated.
- 945 • Value P, to indicate that some of the results, but not all, are available and have been clinically validated. The identity of the clinical expert should in this case be indicated in the OBR-32 field.
- 945 • Value F, to indicate that all results are available and have been clinically validated. The identity of the clinical expert should in this case be indicated in the OBR-32 field.
- 950 • Value C, to indicate that at least one result contained in one of the following OBX segments has been modified after the results have been transmitted with the F status. This value C SHALL NOT be used before results have been transmitted with the F status.
- 950 • Value X, to indicate that the battery/test has been deleted. This deletion could have been, either received from the Order Placer for an already received specimen and accepted by the Order Filler, or decided by the laboratory. This value X should not be used if some results for this test have already been transmitted.

- Value S, although the usage of this value is mainly in response to a Query message. It can be used in OUL messages for tests that have been added to the original request by the Order Filler (LIS). In this case, the value of the OBR-11 field (Action Code) should be either A, or G.

Note: For the conditions of use of these values, please read Volume 2x, Appendix C “Correlations of status between ORC, OBR and OBX”.

OBR-26 Parent Result (PRL), conditional

960 This field is used to report spawned orders in microbiology.

Condition predicate: Populated if OBR-11 (Specimen Action code) is valued "G".

OBR-28 Result Copies To (XCN)

This field may be used to indicate the list of recipients who will receive a hard copy of the results report, which may be useful information for users who have access to these results.

965 OBR-29 Parent (EIP), conditional

This field is used to report spawned orders in microbiology.

Condition predicate: Populated if OBR-11 (Specimen Action code) is valued "G".

OBR-32 Principal Result Interpreter (NDL)

970 This field is required when the value of the Results Status field (OBR-25) is P or F. The field identifies who validated the results, where, and when this clinical validation was performed. It describes completely the clinical validation step.

OBR-33 Assistant Result Interpreter (NDL)

This field is meaningless when the value of the Result Status field is different from P, F or C.

OBR-34 Technician (NDL)

975 This field should not be used, as all observations linked to the battery have not necessarily been performed by the same Technician. The OBX-16 (Responsible Observer) should be used instead.

OBR-35 Transcriptionist (NDL)

980 This field is only applicable when the final report has been dictated and transcribed, which is frequent for Histology and Cytology reports.

OBR-36 Scheduled - Date/Time (TS)

This field is optional and only applies when the value of the Result Status field (OBR-25) is S.

3.3.4.1.2.3 Semantic with the Option Report Facsimile for Order Group

985 When the option Report Facsimile for Order Group is activated the semantic of the result message and behavior of the actors is modified.

If the Order Placer requested this facsimile report service with an Order Group, then:

- 990 • When the Order Filler prepares a message containing some clinically validated results for this Order Group, it SHALL construct and make available in a shared repository the PDF report recapitulating all releasable results obtained by the sending laboratory for this Order Group, and SHALL include a link to this PDF report in the results message.
- 995 • When canceling some results previously transmitted with a PDF report facsimile, if after this cancellation occurs, no result from the sending laboratory remains releasable for this Order Group, then the Order Filler SHALL provide a nullified link in the results message, to request the cancellation without replacement of the report facsimile.
- 1000 • An ORU^R01 message provides the link to the report in a dedicated ORDER_OBSERVATION segment group, appearing at the bottom of the message. This last ORDER_OBSERVATION segment group, which was requested by the Order Placer when the Order Group was placed, is composed of only 3 segments: ORC, OBR, OBX.
- 1005 • An OUL^R22 message provides this link through in a dedicated ORDER segment group appearing at the end of the last SPECIMEN segment group of the message. This last ORDER segment group is composed of only 3 segments: OBR, ORC, OBX.
- In both message structures the 3 segments introducing the PDF report are populated as follows:

The ORC segment contains at least these 3 fields:

Field	DT	Element name	Value	comment
ORC-1	ID	Order Control	SC	<i>A results message is always a Status Change.</i>
ORC-4	EI	Placer Group Number	<i>The Order Group number</i>	<i>The identifier assigned by the Order Placer to this Order Group.</i>
ORC-9	TS	Date/Time of Transaction	<i>Date time of the triggering event</i>	<i>Date/time of this release of the laboratory report produced for this Order Group.</i>

The OBR segment contains at least these 4 fields:

Field	DT	Element name	Value	comment
OBR-2	EI	Placer Order Number	As assigned by Order Placer	
OBR-3	EI	Filler Order Number	As assigned by Order Filler	
OBR-4	CE	Universal Service Identifier		
OBR-4.1	ST	Code	(1)	<i>This code announces the laboratory report</i>
OBR-4.2	ST	Text	(1)	<i>The LOINC name of this code</i>
OBR-4.3	ID	Name of Coding System	LN	<i>Coding system LOINC</i>

Field	DT	Element name	Value	comment
OBR-25	ID	Result Status	P, F, C, X	The report is Preliminary , Final , Corrected (after final) or canceled (X). When existing, it contains only verified results (i.e., clinically validated).

1010

Note 1: Use either the LOINC code “11502-2” and the corresponding name “LABORATORY REPORT.TOTAL” or one of the LOINC codes for laboratory specialties listed in PaLM TF-3.

The OBX segment contains at least these 6 fields:

Field	DT	Element name	Value	comment
OBX-1	SI	Set ID – OBX	1	
OBX-2	ID	Value Type	RP	Reference Pointer
OBX-3		Observation Identifier		
OBX-3.1	ST	Code	(1)	The observation is the laboratory report itself
OBX-3.2	ST	Text	(1)	The LOINC name of this code
OBX-3.3	ID	Name of Coding System	LN	Coding system LOINC
OBX-5	RP	Observation Value		
OBX-5.1	ST	Pointer	URL of the laboratory report	The syntax of the URL SHALL be conformant with RFC1738 and RFC1808.
OBX-5.2	HD	Application ID	unique ID assigned to the OF application	
OBX-5.3	ID	Type Of Data	AP	Other application data. The report is not to be interpreted by a HL7 parser.
OBX-5.4	ID	Subtype	PDF or JPG	The laboratory report is in pdf or jpeg format
OBX-11	ID	Observation Result Status	P, F, C, D, X (2)	The report is Preliminary , Final , Corrected , Deleted , or cannot be produced (X). In the two latter cases (D or X) OBX-5.1 SHALL be nullified (, populated with two double quotes)
OBX-13	ST	User Defined Access Checks	P or empty	P means this report should be viewed only by privileged users.

Note 1: Use either the LOINC ® code “11502-2” and the corresponding name “LABORATORY REPORT.TOTAL” or one of the LOINC codes for laboratory specialties listed in PaLM TF-3.

1015

Note 2: In the situation where the order was previously reported as final, and the Order Filler wants to announce the pending correction of one or more results for this order, the previous report will be cleared by the message announcing this pending correction, using OBX-11 = ‘D’. Once the corrected values are verified and sent, the new report will accompany them.

1020 **3.3.4.1.3 Expected Actions**

Table 3.3.4.1.3-1: Expected Actions by Responder in [LAB-3]

Event	Initiator	Responder	Expected action by the responder
Change of status of an order, with possible new or corrected or deleted or validated results for this order	Order Filler	Order Result Tracker	Store the status and content of the order, and acknowledge with OK.
Result message carrying a link to the pdf report, in the context of option Report Facsimile for Order Group	Order Filler	Order Result Tracker	The Order Result Tracker SHALL follow the link, retrieve the PDF report immediately, and store it attached to the Order Group and its current set of results, replacing any previous report facsimile for this Order Group with this new one.
Result message carrying a nullified link to the pdf report, in the context of option Report Facsimile for Order Group	Order Filler	Order Result Tracker	The Order Result Tracker SHALL mark the previous PDF report for this Order Group as canceled.

3.3.4.2 Message ORU^R01

Preferred message structure for order centered result reporting.

1025 **3.3.4.2.1 Trigger Events**

Identical to 3.3.4.1.1

3.3.4.2.2 Message Semantics

3.3.4.2.2.1 ORU^R01 Static Definition

Table 3.3.4.2.2.1-1: ORU^R01 static definition

Segment	Meaning	Usage	Card.	HL7 chapter
MSH	Message Header	R	[1..1]	2
{	--- PATIENT_RESULT begin	R	[1..1]	
[--- PATIENT begin	RE	[0..1]	
PID	Patient Identification	R	[1..1]	3
[--- PATIENT_VISIT begin	RE	[0..1]	
PV1	Patient Visit	R	[1..1]	3
]	--- PATIENT_VISIT end			
]	--- PATIENT end			
{	--- ORDER_OBSERVATION begin	R	[1..*]	
ORC	Common Order (for one battery)	R	[1..1]	4
OBR	Observation Request	R	[1..1]	4
[{NTE}]	Comments on the order	O	[0..*]	2

Segment	Meaning	Usage	Card.	HL7 chapter
[{	--- TIMING begin	RE	[0..1]	
[{TQ1}]	Timing Quantity	R	[1..1]	4
}]	--- TIMING end			
[{	--- OBSERVATION begin	C	[0..*]	
OBX	Observation related to OBR	R	[1..1]	7
[{NTE}]	Comment of the result	RE	[0..*]	2
}]	--- OBSERVATION end			
[{	--- SPECIMEN begin	RE	[0..*]	
SPM	Specimen	R	[1..1]	7
[{OBX}]	Observation related to specimen	O	[0..*]	
}]	--- SPECIMEN end			
}	--- ORDER_OBSERVATION end			
}	--- PATIENT_RESULT end			

1030

Field MSH-9 – Message Type shall have its three components valued as follows:
ORU^R01^ORU_R01

1035

Condition predicate for the OBSERVATION segment group: This group is present (one or more occurrence) only when OBR-25 from the preceding OBR segment is not in { “X”, “O”, “I”, “S”}.

1040

The observations and notes produced to fulfill an order are reported as OBX and NTE segments in the OBSERVATION segment group following the ORC/OBR pair representing this order. Each specimen used by this order is described as a SPM segment in an instance of the SPECIMEN segment group following the results of the order. Pre-analytical observations qualifying the usability or characteristics (e.g., volume, collection duration, defect ...) of the specimen may be reported in OBX attached to the SPM segment.

1045

Following the ORC/OBR, the Order Filler should systematically transmit in the message, all OBX and SPM segments related to this ORC/OBR. This systematic transmission of all observations linked to an OBR and their respective status may help the Order Result Tracker to recover from error situations.

1050

For the same reason the "U" value should not be used in the Observation Result Status field of an OBX segment.

In case an observation previously transmitted is deleted, the Order Filler should transmit all OBX segments linked to the OBR to which the deleted observation relates to; and it should indicate the current status of each OBX segment. The Observation Result Status field of the OBX that correspond to the deleted observation should be valued with a "D".

Unless the Report Status field (OBR-25) of the OBR is valued with an "X" (deleted battery), the OBR segment shall always be followed by one or several SPM and OBX segments.

1055 TQ1 and ORC segments shall be transmitted because they contain important information such as the priority of the order and the Order Group Number.

3.3.4.2.2 OBR Segment Static Definition

Identical to Section 3.3.4.1.2.2

3.3.4.2.2.3 Semantic with the Option Report Facsimile for Order Group

See Section 3.3.4.1.2.3

1060 **3.3.4.2.3 Expected Actions**

See Section 3.3.4.1.3

3.3.5 Security Considerations

1065 The only security constraint is that both Order Result Tracker and Order Filler be grouped with a Consistent Time Client, as specified in PaLM TF-1, and that these two CT Clients be served by a common Consistent Time Server.

3.4 Work Order Management [LAB-4]

3.4.1 Scope

This transaction is used when the Order Filler issues a new work order to the Automation Manager, or requests for the cancellation or modification of an existing work order.

1070 **3.4.2 Actor Roles**

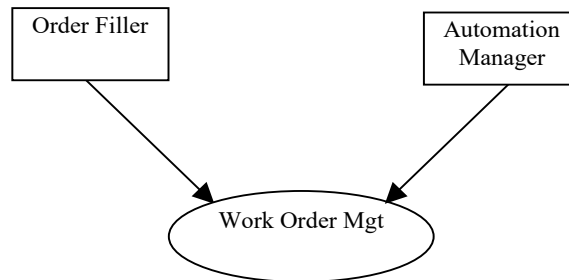

Figure 3.4.2-1: Use Case Diagram

Table 3.4.2-1: Actor Roles

Actor:	Order Filler
Role:	Splits an order into a set of work orders, and sends each work order to the appropriate Automation Manager. Keeps the content of a work order aligned with its originating order, and sends requests to the Automation Manager for cancellation of the work order, or for replacement of its content, when needed.
Actor:	Automation Manager
Role:	Receives work orders from the order filler and organizes their fulfillment. Receives replacement and cancellation requests for work orders and applies them when possible.

3.4.3 Referenced Standards

1075 HL7 version 2.5.1:

- Chapter 2: "Control" --> generic segments and data types
- Chapter 3: "ADT" --> PID and PV1 segments
- Chapter 4: "Order Entry" --> OML and ORL messages
- Chapter 7: "Observation Reporting" --> SPM segment
- Chapter 13: "Clinical Laboratory Automation" --> SAC segment

1080

3.4.3.1 Trigger Events (ORC-1 values) Supported by Transaction [LAB-4]

Transaction [LAB-4] supports three message pairs, which share the same trigger events:

- the creation of a new work order (**NW**) by the Order Filler,
- the replacement (**RP**) of the test /battery in a work order requested by the Order Filler,
- the cancellation (**CA**) of a work order requested by the Order Filler,

1085

3.4.4 Interaction Diagram

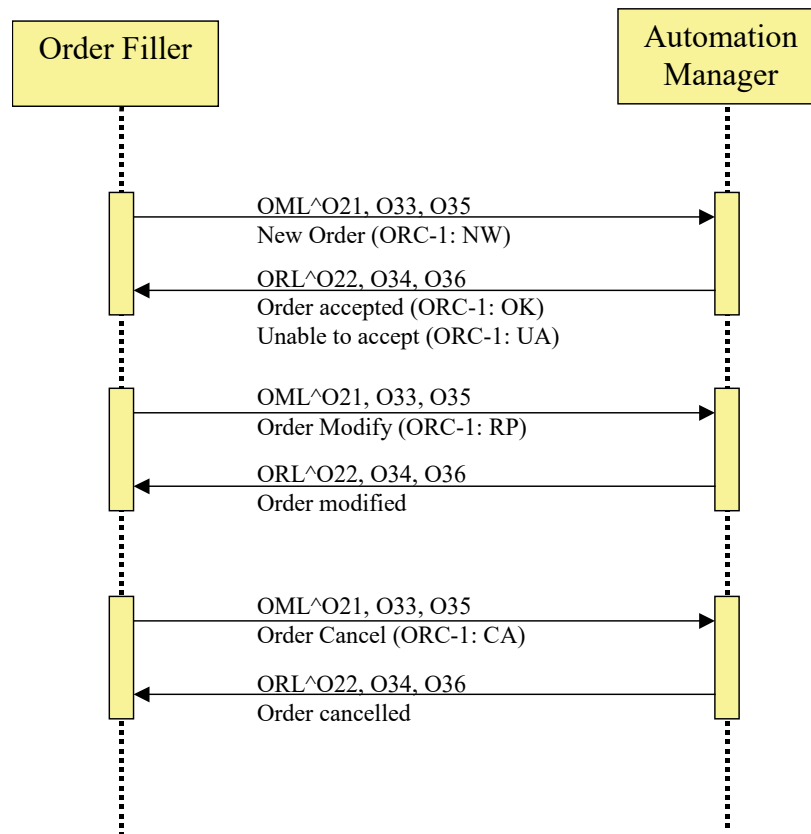

Figure 3.4.4-1: Work Order Management Interactions

3.4.4.1 Message OML^O21 and its Acknowledgement ORL^O22

1090

OML^O21 is a battery/test centric message, with specimen and container information conveyed within the ORDER segment group.

3.4.4.1.1 Trigger Events

See Section 3.4.3.1

3.4.4.1.2 Message Semantics

1095 3.4.4.1.2.1 OML^O21 Static Definition

Table 3.4.4.1.2.1-1: OML^O21 Static Definition

Segment	Meaning	Usage	Card.	HL7 chapter
MSH	Message Header	R	[1..1]	2
[--- PATIENT begin	O	[0..1]	
PID	Patient Identification	R	[1..1]	3
[PV1]	Patient Visit	RE	[0..1]	3
]	--- PATIENT end			
{	--- ORDER begin	R	[1..*]	
ORC	Common Order (for one battery)	R	[1..1]	4
[{TQ1}]	Timing Quantity	RE	[0..1]	4
[--- OBSERVATION REQUEST begin	O	[0..1]	
OBR	Observation Request	R	[1..1]	4
[TCD]	Test Code Details	O	[0..1]	13
[{	--- OBSERVATION begin	O	[0..*]	
OBX	Observation Result	R	[1..1]	7
[{NTE}]	Comment of the result	C	[0..*]	2
}]	--- OBSERVATION end			
[{	--- SPECIMEN begin	C	[0..*]	
SPM	Specimen	R	[1..1]	7
[{	--- CONTAINER begin	C	[0..*]	
SAC	Specimen Container	R	[1..1]	13
[{OBX}]	Additional specimen characteristics	O	[0..*]	7
}]	--- CONTAINER end			
}]	--- SPECIMEN end			
[{	--- PRIOR_RESULT begin	O	[0..*]	
PV1	Patient Visit - previous result	R	[1..1]	3
{	--- ORDER_PRIOR begin	R	[1..*]	
[ORC]	Common Order - previous result	R	[1..1]	4
OBR	Order Detail - previous result	R	[1..1]	4
{ [NTE] }	Notes and Comments - previous result	O	[0..*]	2
{	--- OBSERVATION_PRIOR begin	R	[1..*]	
OBX	Observation/Result - previous result	R	[1..1]	7
{ [NTE] }	Notes and Comments - previous result	O	[0..*]	2
}	--- OBSERVATION_PRIOR end			

Segment	Meaning	Usage	Card.	HL7 chapter
}	--- ORDER_PRIOR end			
]} }	--- PRIOR_RESULT end			
]	--- OBSERVATION REQUEST end			
}	--- ORDER end			

Field MSH-9 – Message Type shall have its three components valued as follows:
OML^O21^OML_O21

1100 PV1 is optional since the Automation Manager and the laboratory devices do not usually need the outpatient information.

1105 The SPECIMEN group is required when the specimen has already been collected and prepared, and is registered in the Order Filler application. In this case, there is at least one SPM segment present in this group. Below each SPM segment, the condition of use of the SAC segment is the one described in the paragraph describing this segment, Section 3.10.

The OBX segment in the OBSERVATION group is used for providing observations, which can support the execution of the work order, including the technical validation of its results.

1110 The optional and repeatable PRIOR RESULT segment group provides the prior results obtained for the same patient. Segment PID is not provided in this segment group because it is the same patient, and the laboratory is not concerned by the fact that this patient might have had a different identification when the prior results were produced.

1115 Segment PV1, which is the first segment of the segment group PRIOR RESULT, is mandatory. The presence of this segment at this point in the message structure announces unambiguously a set of prior orders with related prior observations. The segment PV1 represents the patient visit (or encounter) during which these prior observations were produced. The only field mandatory in the segment PV1 is PV1-2 “Patient Class” (as shown in Appendix C of Volume 2x). If the sender of this message does not know the patient class, it SHALL value the field PV1-2 “U”, which stands for “patient class unknown”.

1120 The ORC appearing in the PRIOR RESULT segment group is mandatory and SHALL have its first field “Order Control” populated with “PR” (Prior results).

3.4.4.1.2.2 ORL^O22 Static Definition

Table 3.4.4.1.2.2-1: ORL^O22 static definition

Segment	Meaning	Usage	Card.	HL7 chapter
MSH	Message header	R	[1..1]	2
MSA	Message Acknowledgement	R	[1..1]	2
[{ERR}]	Error	O	[0..*]	2

Segment	Meaning	Usage	Card.	HL7 chapter
[--- RESPONSE begin	X	[0..0]	
[--- PATIENT begin	O	[0..1]	
PID	Patient Identification	R	[1..1]	3
{	--- ORDER begin	R	[1..*]	
ORC	Common Order	R	[1..*]	4
[{TQ1}]	Timing/Quantity	RE	[0..1]	4
[--- OBSERVATION REQUEST begin	O	[0..1]	
OBR	Observation Request	R	[1..1]	4
[{	--- SPECIMEN begin	C	[0..*]	
SPM	Specimen	R	[1..1]	7
[{SAC}]	Specimen Container Details	C	[0..*]	7
}}	--- SPECIMEN end			
]	--- OBSERVATION end			
}}	--- OBSERVATION REQUEST end			
]	--- ORDER end			
]	--- PATIENT end			
]	--- RESPONSE end			

1125 Field MSH-9 – Message Type shall have its three components valued as follows:
ORL^O22^ORL_O22

This message never carries the RESPONSE segment group. It is therefore limited to the first two or three segments.

3.4.4.1.2.3 OBR Segment Static Definition

Table 3.4.4.1.2.3-1: OBR Segment Static Definition

SEQ	LEN	DT	Usage	Card.	TBL#	ITEM#	Element name
1	4	SI	O	[0..1]		00237	Set ID – OBR
2	22	EI	R	[1..1]		00216	Placer Order Number
3	22	EI	RE	[0..1]		00217	Filler Order Number
4	250	CE	R	[1..1]		00238	Universal Service Identifier
5	2	ID	X	[0..0]		00239	Priority – OBR
6	26	TS	X	[0..0]		00240	Requested Date/Time
7	26	TS	X	[0..0]		00241	Observation Date/Time #
8	26	TS	X	[0..0]		00242	Observation End Date/Time #
9	20	CQ	X	[0..0]		00243	Collection Volume
10	250	XCN	O	[0..*]		00244	Collector Identifier
11	1	ID	RE	[0..1]	0065	00245	Specimen Action Code

IHE Pathology & Laboratory Medicine Technical Framework, Vol. 2a (PaLM TF-2a):
Transactions

SEQ	LEN	DT	Usage	Card.	TBL#	ITEM#	Element name
12	250	CE	X	[0..0]		00246	Danger Code
13	300	ST	X	[0..0]		00247	Relevant Clinical Information
14	26	TS	X	[0..0]		00248	Specimen Received Date/Time *
15	300	SPS	X	[0..0]		00249	Specimen Source
16	250	XCN	R	[1..1]		00226	Ordering Provider
17	250	XTN	RE	[0..2]		00250	Order Callback Phone Number
18	60	ST	X	[0..0]		00251	Placer Field 1
19	60	ST	X	[0..0]		00252	Placer Field 2
20	60	ST	X	[0..0]		00253	Filler Field 1 +
21	60	ST	X	[0..0]		00254	Filler Field 2 +
22	26	TS	X	[0..0]		00255	Results Rpt/Status Chng - Date/Time +
23	40	MOC	X	[0..0]		00256	Charge to Practice +
24	10	ID	C	[0..1]	0074	00257	Diagnostic Serv Sect ID
25	1	ID	X	[0..0]	0123	00258	Result Status +
26	400	PRL	X	[0..0]		00259	Parent Result +
27	200	TQ	X	[0..0]		00221	Quantity/Timing
28	250	XCN	O	[0..*]		00260	Result Copies To
29	200	EIP	X	[0..0]		00261	Parent
30	20	ID	X	[0..0]	0124	00262	Transportation Mode
31	250	CE	O	[0..1]		00263	Reason for Study
32	200	NDL	O	[0..1]		00264	Principal Result Interpreter +
33	200	NDL	O	[0..1]		00265	Assistant Result Interpreter +
34	200	NDL	O	[0..1]		00266	Technician +
35	200	NDL	O	[0..1]		00267	Transcriptionist +
36	26	TS	O	[0..1]		00268	Scheduled Date/Time +
37	4	NM	O	[0..1]		01028	Number of Sample Containers *
38	250	CE	O	[0..1]		01029	Transport Logistics of Collected Sample *
39	250	CE	O	[0..1]		01030	Collector's Comment *
40	250	CE	X	[0..0]		01031	Transport Arrangement Responsibility
41	30	ID	X	[0..0]	0224	01032	Transport Arranged
42	1	ID	X	[0..0]	0225	01033	Escort Required
43	250	CE	X	[0..0]		01034	Planned Patient Transport Comment
44	250	CE	O	[0..1]	0088	00393	Procedure Code
45	250	CWE	O	[0..1]	0340	01316	Procedure Code Modifier
46	250	CE	O	[0..1]	0411	01474	Placer Supplemental Service Information

SEQ	LEN	DT	Usage	Card.	TBL#	ITEM#	Element name
47	250	CE	O	[0..1]	0411	01475	Filler Supplemental Service Information
48	250	CWE	X	[0..0]	0476	01646	Medically Necessary Duplicate Procedure Reason.
49	2	IS	O	[0..1]	0507	01647	Result Handling

1130

OBR-2 Placer Order Number represents the work order identifier assigned by the Order Filler. This field shall be reflected in a test result message in transaction [LAB-5].

3.4.4.1.2.4 TCD Segment Static Definition

Table 3.4.4.1.2.4-1: TCD Segment Static Definition

SEQ	LEN	DT	Usage	Card.	TBL #	ITEM#	Element name
1	250	CE	R	[1..1]		00238	Universal Service Identifier
2	20	SN	O	[0..1]		01420	Auto-Dilution Factor
3	20	SN	O	[0..1]		01421	Rerun Dilution Factor
4	20	SN	O	[0..1]		01422	Pre-Dilution Factor
5	20	SN	O	[0..1]		01413	Endogenous Content of Pre-Dilution Diluent
6	1	ID	O	[0..1]	0136	01416	Automatic Repeat Allowed
7	1	ID	O	[0..1]	0136	01424	Reflex Allowed
8	250	CE	O	[0..1]	0389	01425	Analyte Repeat Status

1135

3.4.4.1.3 Expected Actions

Table 3.4.4.1.3-1: Expected Actions by Responder in [LAB-4]

Event	Initiator	Responder	Expected action by the responder
New order placed (NW)	Order Filler	Automation Manager	check the work order content, if accepted, store it and respond OK, otherwise respond “unable to accept” (UA)
Request for replacement of a test/battery (RP)	Order Filler	Automation Manager	Check whether the action is possible, considering the work potentially already in progress on the work order. If accepted respond “replaced as requested (RQ) otherwise respond “unable to “replace” (UM)
Request for cancellation of an order (CA)	Order Filler	Automation Manager	Check whether the action is possible, considering the work potentially already in progress on the work order. If accepted respond “canceled as requested (CR) otherwise respond “unable to “cancel” (UC)

3.4.4.2 Message OML^O33 and its Acknowledgement ORL^O34

1140 OML^O33 is a specimen centric message, with container and work order information conveyed within the SPECIMEN segment group.

3.4.4.2.1 Trigger Events

See Section 3.4.3.1

3.4.4.2.2 Message Semantics

3.4.4.2.2.1 OML^O33 Static Definition

1145

Table 3.4.4.2.2.1-1: OML^O33 Static Definition

Segment	Meaning	Usage	Card.	HL7 chapter
MSH	Message Header	R	[1..1]	2
[--- PATIENT begin	O	[0..1]	
PID	Patient Identification	R	[1..1]	3
[PV1]	Patient Visit	RE	[0..1]	3
]	--- PATIENT end			
{	--- SPECIMEN begin	R	[1..*]	
SPM	Specimen	R	[1..1]	7
[{SAC}]	Specimen Container	O	[0..*]	
{	--- ORDER begin	R	[1..*]	
ORC	Common Order (for one battery)	R	[1..1]	4
[{TQ1}]	Timing Quantity	RE	[0..1]	4
[--- OBSERVATION REQUEST begin	O	[0..1]	
OBR	Observation Request	R	[1..1]	4
[TCD]	Test Code Details	O	[0..1]	13
[{OBX}]	Observation Result	C	[0..*]	7
{	--- PRIOR RESULT start	O	[0..*]	
[PV1]	Patient Visit	R	[1..1]	3
[ORC]	Common order – prior result	R	[1..1]	4
OBR	Order detail – prior result	R	[1..1]	4
{OBX}	Observation/Result – prior result	R	[1..*]	
[{NTE}]	Comment of the result	C	[0..*]	2
}	--- PRIOR RESULT end			
]	--- OBSERVATION REQUEST end			
}	--- ORDER end			
}	--- SPECIMEN end			

MSH-9 - Message Type (MSG) shall have its three components respectively valued to “OML”, “O33”, and “OML_O33”.

1150 The SAC segment should be used only to provide information specific to that segment, i.e., having no placeholder in the SPM segment.

The usage of the PRIOR RESULT segment group is identical as in OML^O21. See Section 3.4.4.1.2.1.

3.4.4.2.2.2 ORL^O34 Static Definition

Table 3.4.4.2.2.2-1: ORL^O34 Static Definition

Segment	Meaning	Usage	Card.	HL7 chapter
MSH	Message header	R	[1..1]	2
MSA	Message Acknowledgement	R	[1..1]	2
[{ERR}]	Error	O	[0..*]	2
[--- RESPONSE begin	X	[0..0]	
[--- PATIENT begin	R	[1..1]	
[PID]	Patient Identification	R	[1..1]	3
{	--- SPECIMEN begin	R	[1..*]	
SPM	Specimen	R	[1..1]	7
[{SAC}]	Specimen Container	O	[0..*]	13
[{	--- ORDER begin	O	[0..*]	
ORC	Common Order	R	[1..1]	4
[{TQ1}]	Timing/Quantity	RE	[0..1]	4
[OBR]	Observation Request	R	[1..1]	4
}]	--- ORDER end			
}	--- SPECIMEN end			
]	--- PATIENT end			
]	--- RESPONSE end			

1155

MSH-9 - Message Type (MSG) shall have its three components respectively valued to “ORL”, “O34” and “ORL_O34”.

This message never carries the RESPONSE segment group. It is therefore limited to the first two or three segments.

1160 3.4.4.2.2.3 OBR Segment Static Definition

Same as in in OML^O21. See Section 3.4.4.1.2.3

3.4.4.2.2.4 TCD Segment Static Definition

Same as in OML^O21. See Section 3.4.4.1.2.4

3.4.4.2.3 Expected Actions

1165 See Section 3.4.4.1.3.

3.4.4.3 Message OML^O35 and its Acknowledgement ORL^O36

OML^O35 is a specimen-in-a-container centric message, with container and work order information conveyed within the CONTAINER segment group.

3.4.4.3.1 Trigger Events

1170 See Section 3.4.3.1.

3.4.4.3.2 Message Semantics

3.4.4.3.2.1 OML^O35 Static Definition

Table 3.4.4.3.2.1-1: OML^O35 Static Definition

Segment	Meaning	Usage	Card.	HL7 chapter
MSH	Message header	R	[1..1]	2
[--- PATIENT begin	O	[0..1]	
PID	Patient identification	R	[1..1]	3
[PV1]	Patient visit	RE	[0..1]	3
]	--- PATIENT end			
{	--- SPECIMEN begin	R	[1..*]	
SPM	Specimen	R	[1..1]	7
{	--- CONTAINER begin	R	[1..*]	
SAC	Specimen Container	R	[1..1]	13
{	--- ORDER begin	R	[1..*]	
ORC	Common order	R	[1..1]	4
[{TQ1}]	Timing/Quantity Order Sequence	RE	[0..1]	4
[--- OBSERVATION REQUEST begin	O	[0..1]	
OBR	Observation Request	R	[1..1]	4
[TCD]	Test Code Details	O	[0..1]	13
[{OBX}]	Additional specimen characteristics	O	[0..*]	7
{	--- PRIOR RESULT begin	O	[0..*]	
[PV1]	Patient Visit	R	[1..1]	3
[ORC]	Common order – prior result	O	[0..1]	4
OBR	Order detail – prior result	R	[1..1]	4
{OBX}	Observation/Result - prior result	R	[1..*]	7

Segment	Meaning	Usage	Card.	HL7 chapter
}	--- PRIOR RESULT end			
]	--- OBSERVATION REQUEST end			
}	--- ORDER end			
}	--- CONTAINER end			
}	--- SPECIMEN end			

1175 Field MSH-9 - Message Type (MSG) shall have its three components respectively valued to “OML”, “O35” and “OML_O35”.

The SAC segment below the SPM segment is mandatory in OML^O35 message structure.

The usage of the PRIOR RESULT segment group and of the OBSERVATION segment group are identical as in OML^O21. See Section 3.4.4.1.2.1.

1180 3.4.4.3.2.2 ORL^O36 Static Definition

Table 3.4.4.3.2.2-1: ORL^O36 Static Definition

Segment	Meaning	Usage	Card.	HL7 chapter
MSH	Message header	R		2
MSA	Message Acknowledgement	R		2
[{ERR}]	Error	O		2
[--- RESPONSE begin	X	[0..0]	
[--- PATIENT begin	R	[1..1]	
[PID]	Patient Identification	O	[0..1]	3
{	--- SPECIMEN begin	R	[1..*]	
SPM	Specimen	R	[1..1]	7
{	--- CONTAINER begin	R	[1..*]	
SAC	Specimen Container	R	[1..1]	13
[{	--- ORDER begin	O	[0..*]	
ORC	Common Order	R	[1..1]	4
[{TQ1}]	Timing/Quantity	RE	[0..1]	4
[OBR]	Observation Request	R		4
}]	--- ORDER end			
}	--- CONTAINER end			
}	--- SPECIMEN END			
]	--- PATIENT end			
]	--- RESPONSE end			

MSH-9 - Message Type (MSG) shall have its three components respectively valued to “ORL”, “O36” and “ORL_O36”.

1185 This message never carries the RESPONSE segment group. It is therefore limited to the first two or three segments.

3.4.4.3.2.3 OBR Segment Static Definition

Same as in in OML^O21. See Section 3.4.4.1.2.3

3.4.4.3.2.4 TCD Segment Static Definition

1190 Same as in OML^O21. See Section 3.4.4.1.2.4

3.4.4.3.3 Expected Actions

See Section 3.4.4.1.3.

3.4.5 Security Considerations

1195 The only security constraint is that both Order Result Tracker and Order Filler be grouped with a Consistent Time Client, as specified in PaLM TF-1, and that these two CT Clients be served by a common Consistent Time Server.

3.5 Test Results Management [LAB-5]

3.5.1 Scope

1200

This transaction is used by the Automation Manager to transmit the test results fulfilling a work order to the Order Filler.

3.5.2 Actor Roles

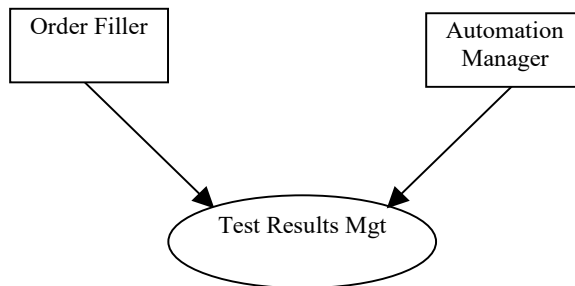

Figure 3.5.2-1: Use Case Diagram

Table 3.5.2-1: Actor Roles

Actor:	Order Filler
Role:	Receives test results fulfilling work orders from the Automation Manager
Actor:	Automation Manager
Role:	Performs the technical validation of the test results and sends the results technically validated to the Order Filler.

1205

3.5.3 Referenced Standards

HL7 version 2.5.1:

- Chapter 2: "Control" --> generic segments and data types
- Chapter 7: "Observation Reporting"

3.5.4 Interaction Diagram

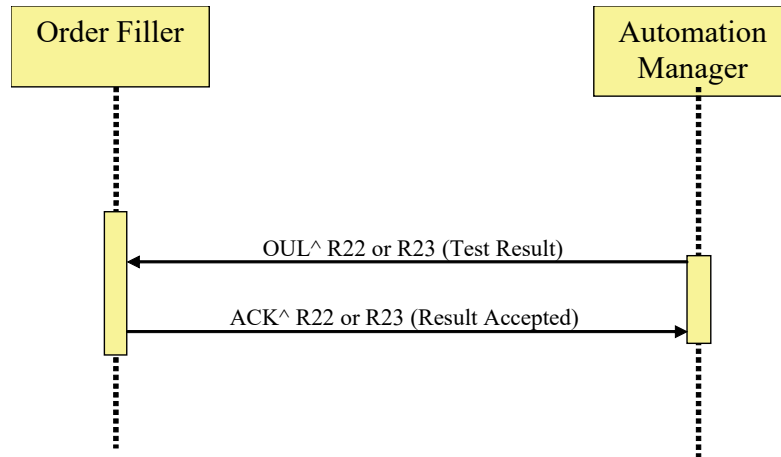

1210

Figure 3.5.4-1: Unsolicited Observation Message from Automation Manager

3.5.4.1 Message OUL^R22 and its Acknowledgement ACK^R22

The use of OUL^R22 is recommended when transferring multiple results related to a specimen.

3.5.4.1.1 Trigger Events

1215

New test results for a work order are technically validated.

3.5.4.1.2 Message Semantics

3.5.4.1.2.1 OUL^R22 Static Definition

Table 3.5.4.1.2.1-1: OUL^R22 Static Definition

Segment	Meaning	Usage	Card.	HL7 chapter
MSH	Message header	R	[1..1]	2
[PID]	Patient Identification	RE	[0..1]	3
[PV1]	Patient Visit	O	[0..1]	3
{	--- SPECIMEN begin	R	[1..*]	
SPM	Specimen information	R	[1..1]	7
[{ OBX }]	Observation Result (for Specimen)	O	[0..*]	7
[{	--- CONTAINER begin	0	[0..*]	
SAC	Container information	R	[1..1]	13
[INV]	Detailed Substance information (e.g., id, lot, manufacturer, ... of QC specimen)	O	[0..1]	13
}]	--- CONTAINER end			
{	--- ORDER begin	R	[1..*]	
OBR	Observation Order	R	[1..1]	7

Segment	Meaning	Usage	Card.	HL7 chapter
[ORC]	Common Order	O	[0..1]	4
[{NTE}]	Comment on the Work Order	O	[0..*]	2
[{	--- RESULT begin	O	[0..*]	
OBX	Observation Result	R	[1..1]	7
[TCD]	Test Code Detail	O	[0..1]	13
[{SID}]	Substance Identifier (e.g., reagents used for testing)	O	[0..*]	13
[{NTE}]	Notes and comments	O	[0..*]	
}]	--- RESULT end			
}	--- ORDER end			
}	--- SPECIMEN end			

1220 Field MSH-9 – Message Type shall have its three components valued as follows:
OUL^R22^OUL_R22

In case of notifying the test results of a patient's specimen the carrier information uses SAC.

3.5.4.1.2.2 ACK^R22 Static Definition

Table 3.5.4.1.2.2-1: ACK^R22 Static Definition

Segment	Meaning	Usage	Card.	HL7 chapter
MSH	Message header	R	[1..1]	2
MSA	Message Acknowledgement	R	[1..1]	2
[ERR]	Error	O	[0..1]	2

1225

Field MSH-9 - Message Type (MSG) shall have its three components respectively valued to "ACK", "R22" and "ACK".

3.5.4.1.3 Expected Actions

Table 3.5.4.1.3-1: Expected Actions by Responder in [LAB-5]

Event	Initiator	Responder	Expected action by the responder
Test result technically validated	Automation Manager	Order Filler	Store the results in the appropriate work order, and acknowledge with OK.

1230 3.5.4.2 Message OUL^R23 and its Acknowledgement ACK^R23

The use of OUL^R23 is recommended when transferring multiple results related to one or more specific containers with one or more specimens.

3.5.4.2.1 Trigger Events

New test results for a work order are technically validated.

1235 3.5.4.2.2 Message Semantics

3.5.4.2.2.1 OUL^R23 Static Definition

Table 3.5.4.2.2.1-1: OUL^R23

Segment	Meaning	Usage	Card.	HL7 chapter
MSH	Message header	R	[1..1]	2
[PID]	Patient Identification	RE	[0..1]	3
[PV1]	Patient Visit	O	[0..1]	3
{	--- SPECIMEN begin	R	[1..*]	
SPM	Specimen information	R	[1..1]	7
[{ OBX }]	Observation Result (for Specimen)	O	[0..*]	7
{	--- CONTAINER begin	R	[1..*]	
SAC	Container information	R	[1..1]	13
[INV]	Detailed Substance information (e.g., id, lot, manufacturer, ... of QC specimen)	O	[0..1]	13
{	--- ORDER begin	R	[1..*]	
OBR	Observation Order	R	[1..1]	7
[ORC]	Common Order	O	[0..1]	4
[{NTE}]	Comment on the Work Order	O	[0..*]	2
[{	--- RESULT begin	O	[0..*]	
OBX	Observation Result	R	[1..1]	7
[TCD]	Test Code Detail	O	[0..1]	13
[{SID}]	Substance Identifier (e.g., reagents used for testing)	O	[0..*]	13
[{NTE}]	Notes and comments	O	[0..*]	
}]	--- RESULT end			
}	--- ORDER end			
}	--- CONTAINER end			
}	--- SPECIMEN end			

1240 Field MSH-9 – Message Type shall have its three components valued as follows:
OUL^R23^OUL_R23.

The carrier information in the case of notifying the test results of a patient's sample uses SAC. Refer to HL7 Chapter 13 for INV, SID segments and refer to HL7 Chapter 7 for CTI segment.

3.5.4.2.2.2 ACK^R23 Static Definition

Table 3.5.4.2.2-1: ACK^R23 Static Definition

Segment	Meaning	Usage	Card.	HL7 chapter
MSH	Message header	R	[1..1]	2
MSA	Message Acknowledgement	R	[1..1]	2
[ERR]	Error	O	[0..1]	2

1245

Field MSH-9 - Message Type (MSG) shall have its three components respectively valued to "ACK", "R23" and "ACK".

3.5.4.2.3 Expected Actions

See Section 3.5.4.1.3.

1250 3.5.5 Security Considerations

The only security constraint is that both Order Result Tracker and Order Filler be grouped with a Consistent Time Client, as specified in PaLM TF-1, and that these two CT Clients be served by a common Consistent Time Server.

3.6 Specimen Work Order Step Download [LAB-21]

1255 **3.6.1 Scope**

This transaction is used between an Automation Manager and a Pre/Post-processor working in download mode. It enables the Automation Manager to issue a new specimen work order step (SWOS) to the Pre/post-processor, or cancel or modify an existing SWOS previously sent. Modification may also be achieved by combining cancellation and sending of a new SWOS.

1260 **3.6.2 Actor Roles**

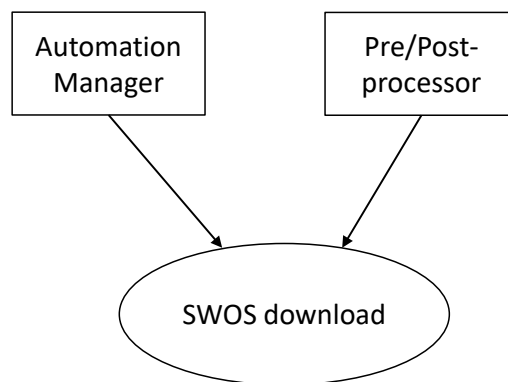

Figure 3.6.2-1: Use Case Diagram

Table 3.6.2-1: Actor Roles

Actor:	Automation Manager
Role:	Converts a work order into a set of SWOS assigned to Pre/Post-processors. Downloads each SWOS to the appropriate Pre/Post-processor.
Actor:	Pre/Post-processor
Role:	Receives SWOS from the Automation Manager

3.6.3 Referenced Standards

1265 HL7 version 2.5.1:

- Chapter 4: "Order Entry" --> OML and ORL messages
- Chapter 7: "Observation Reporting" --> SPM segment
- Chapter 13: "Clinical Laboratory Automation" --> SAC segment

3.6.4 Interaction Diagram

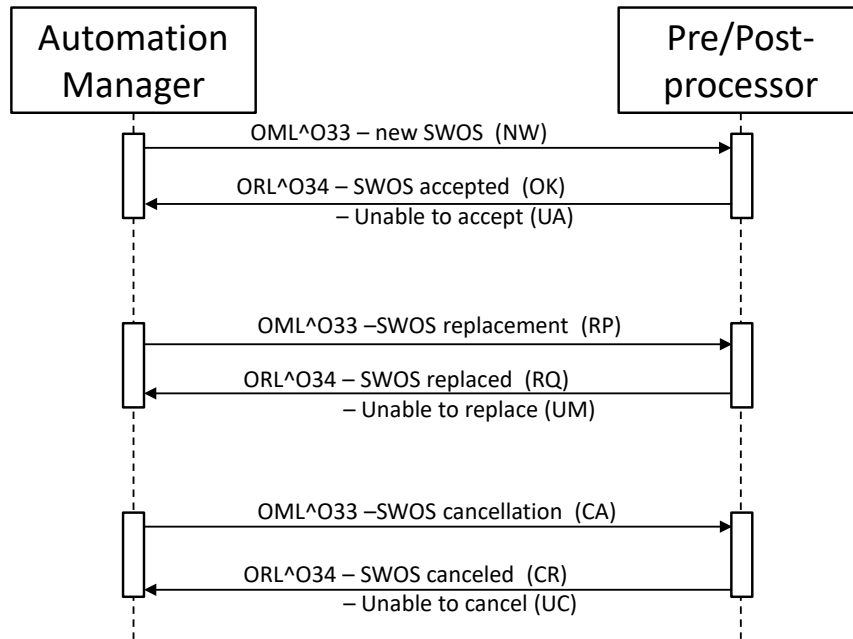

1270

Figure 3.6.4-1: SWOS download on Pre/Post-processor

3.6.4.1 Message OML^O33 and its Acknowledgement

3.6.4.1.1 Trigger Events

- New SWOS assigned to Pre/Post-processor: ORC-1 = "NW".
- Request for replacement of SWOS on specimen: ORC-1 = "RP".
- Request for cancellation of SWOS on specimen: ORC-1 = "CA".

1275

3.6.4.1.2 Message Semantics

3.6.4.1.2.1 OML^O33 Static Definition

Table 3.6.4.1.2.1-1: OML^O33 Static Definition

Segment	Meaning	Usage	Card.	HL7 chapter
MSH	Message Header	R	[1..1]	2
[--- PATIENT begin	O	[0..1]	
PID	Patient Identification	R	[1..1]	3
[{ NTE }	Notes and Comments (for Patient)	O	[0..*]	2
[PV1]	Patient Visit	RE	[0..1]	3
]	--- PATIENT end			

Segment	Meaning	Usage	Card.	HL7 chapter
{	--- SPECIMEN begin	R	[1..1]	
SPM	Specimen	R	[1..1]	7
[{SAC}]	Specimen Container	O	[0..1]	
{	--- ORDER begin	R	[1..1]	
ORC	Common Order (for one battery)	R	[1..1]	4
[{TQ1}]	Timing Quantity	RE	[0..1]	4
	--- OBSERVATION REQUEST begin	R	[1..1]	
OBR	Observation Request	R	[1..1]	4
[TCD]	Test Code Details	O	[0..1]	13
{	--- OBSERVATION begin	O	[0..*]	
OBX	Observation Result	R	[1..*]	7
[TCD]	Test Code Detail	O	[0..*]	13
[{ NTE }]	Notes and Comments (for Results)	O	[0..*]	2
}}	--- OBSERVATION end			
{	--- PRIOR RESULT begin	O	[0..*]	
PV1	Patient Visit – previous result	R	[1..1]	3
{	--- ORDER PRIOR begin	R	[1..*]	
ORC	Common order – prior result	R	[1..1]	4
OBR	Order detail – prior result	R	[1..1]	4
{	--- OBSERVATION PRIOR begin	R	[1..*]	
OBX	Observation/Result – prior result	R	[1..*]	
[{NTE}]	Comment of the result	C	[0..*]	2
}	--- OBSERVATION PRIOR end			
}	--- ORDER PRIOR end			
}}]	--- PRIOR RESULT end			
	--- OBSERVATION REQUEST end			
}	--- ORDER end			
}	--- SPECIMEN end			

1280

MSH-9 - Message Type (MSG) shall have its three components respectively valued to "OML", "O33" and "OML_O33".

3.6.4.1.2.2 ORL^O34 Static Definition

Table 3.6.4.1.2.2-1: ORL^O34 Static Definition

Segment	Meaning	Usage	Card.	HL7 chapter
MSH	Message header	R	[1..1]	2
MSA	Message Acknowledgement	R	[1..1]	2

Segment	Meaning	Usage	Card.	HL7 chapter
[{ERR}]	Error	O	[0..*]	2
[--- RESPONSE begin	O	[0..1]	
[--- PATIENT begin	R	[1..1]	
[PID]	Patient Identification	R	[1..1]	3
{	--- SPECIMEN begin	R	[1..*]	
SPM	Specimen	R	[1..1]	7
[{SAC}]	Specimen Container	O	[0..*]	13
{	--- ORDER begin	O	[0..*]	
ORC	Common Order	R	[1..1]	4
[{TQ1}]	Timing/Quantity	RE	[0..1]	4
[OBR]	Observation Request	R	[1..1]	4
}]	--- ORDER end			
}	--- SPECIMEN end			
]	--- PATIENT end			
]	--- RESPONSE end			

1285

MSH-9 - Message Type (MSG) shall have its three components respectively valued to "ORL", "O34" and "ORL_O34".

3.6.4.1.2.3 OBR Segment Static Definition

Table 3.6.4.1.2.3-1: OBR Static Definition

SEQ	LEN	DT	Usage	Card.	TBL #	ITEM#	Element name
2	22	EI	R	[1..1]		00216	Placer Order Number
3	22	EI	RE	[0..1]		00217	Filler Order Number
4	250	CE	R	[1..1]		00238	Universal Service Identifier
5	2	ID	X	[0..0]		00239	Priority – OBR
6	26	TS	X	[0..0]		00240	Requested Date/Time
7	26	TS	X	[0..0]		00241	Observation Date/Time #
8	26	TS	X	[0..0]		00242	Observation End Date/Time #
9	20	CQ	X	[0..0]		00243	Collection Volume
11	1	ID	RE	[0..1]	0065	00245	Specimen Action Code
12	250	CE	X	[0..0]		00246	Danger Code
13	300	ST	X	[0..0]		00247	Relevant Clinical Information
14	26	TS	X	[0..0]		00248	Specimen Received Date/Time *
15	300	SPS	X	[0..0]		00249	Specimen Source
16	250	XCN	R	[1..1]		00226	Ordering Provider

SEQ	LEN	DT	Usage	Card.	TBL #	ITEM#	Element name
17	250	XTN	RE	[0..2]		00250	Order Callback Phone Number
18	60	ST	X	[0..0]		00251	Placer Field 1
19	60	ST	X	[0..0]		00252	Placer Field 2
20	60	ST	X	[0..0]		00253	Filler Field 1 +
21	60	ST	X	[0..0]		00254	Filler Field 2 +
22	26	TS	X	[0..0]		00255	Results Rpt/Status Chng - Date/Time +
23	40	MOC	X	[0..0]		00256	Charge to Practice +
24	10	ID	C	[0..1]	0074	00257	Diagnostic Serv Sect ID
25	1	ID	X	[0..0]	0123	00258	Result Status +
26	400	PRL	X	[0..0]		00259	Parent Result +
27	200	TQ	X	[0..0]		00221	Quantity/Timing
29	200	EIP	X	[0..0]		00261	Parent
30	20	ID	X	[0..0]	0124	00262	Transportation Mode
40	250	CE	X	[0..0]		01031	Transport Arrangement Responsibility
41	30	ID	X	[0..0]	0224	01032	Transport Arranged
42	1	ID	X	[0..0]	0225	01033	Escort Required
43	250	CE	X	[0..0]		01034	Planned Patient Transport Comment
48	250	CWE	X	[0..0]	0476	01646	Medically Necessary Duplicate Procedure Reason.

1290 **3.6.4.1.2.4 TCD Segment Static Definition**

Table 3.6.4.1.2.4-1: TCD Static Definition

SEQ	LEN	DT	Usage	Card.	TBL #	ITEM#	Element name
1	250	CE	R	[1..1]		00238	Universal Service Identifier
2	20	SN	O	[0..1]		01420	Auto-Dilution Factor
3	20	SN	O	[0..1]		01421	Rerun Dilution Factor
4	20	SN	O	[0..1]		01422	Pre-Dilution Factor
5	20	SN	O	[0..1]		01413	Endogenous Content of Pre-Dilution Diluent
6	1	ID	O	[0..1]	0136	01416	Automatic Repeat Allowed
7	1	ID	O	[0..1]	0136	01424	Reflex Allowed
8	250	CE	O	[0..1]	0389	01425	Analyte Repeat Status

Note: Universal Service Identifier is a copy of OBR-4.

3.6.4.1.3 Expected Actions

Table 3.6.4.1.3-1: Expected Actions by Responder in [LAB-21]

Event	Initiator	Responder	Expected action by the responder
New SWOS (NW)	Automation Manager	Pre/Post-processor	Store SWOS and acknowledge with OK.
Request for replacement of SWOS (RP)	Automation Manager	Pre/Post-processor	Replace SWOS and acknowledge with RQ (or UM if unable to replace).
Request for cancellation of SWOS (CA)	Automation Manager	Pre/Post-processor	Cancel SWOS and acknowledge with CR (or UC if unable to cancel).

1295 **3.6.5 Security Considerations**

None.

3.7 Specimen Work Order Step Query [LAB-22]

3.7.1 Scope

1300 This transaction is used by the Pre/Post-processor to get the SWOS corresponding to a specimen, by querying the Automation Manager after specimen recognition. The transaction provides a query for SWOS on multiple specimens and the reply will convey for each specimen zero or one container and one SWOS.

3.7.2 Actor Roles

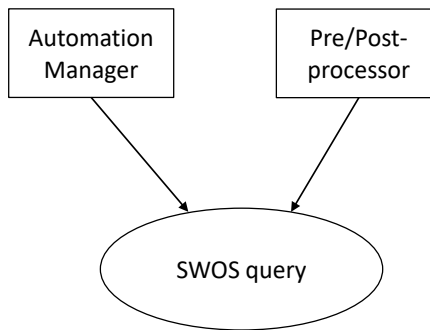

1305 **Figure 3.7.2-1: Use Case Diagram**

Table 3.7.2-1: Actor Roles

Actor:	Pre/Post-processor
Role:	Queries the Automation Manager for a SWOS related to a specimen, and receives the SWOS as the response.
Actor:	Automation Manager
Role:	Manages Work Orders and related SWOS. Responds to queries from the Pre/Post-processor with the appropriate SWOS.

3.7.3 Referenced Standards

HL7 version 2.5.1:

- Chapter 5: "Query" --> QBP and RSP messages

1310 **3.7.4 Interaction Diagram**

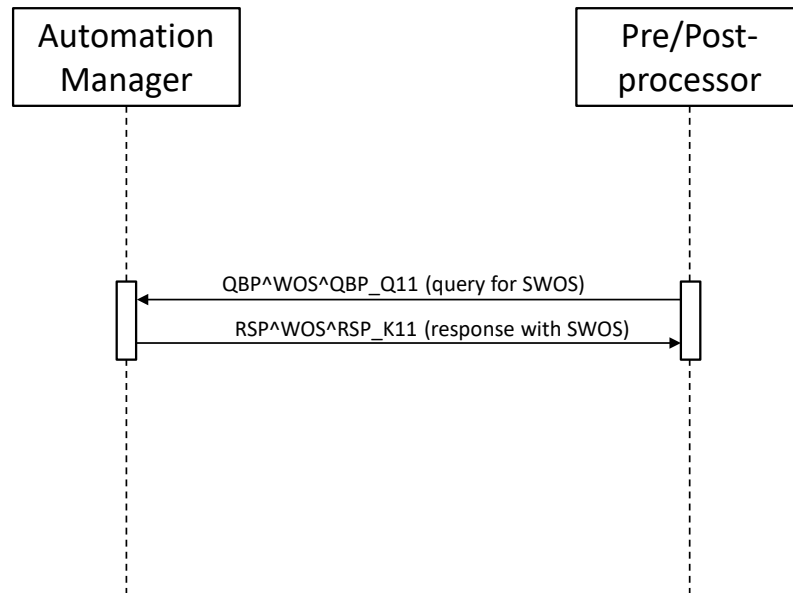

Figure 3.7.4-1: SWOS query by Pre/Post-processor

3.7.4.1 Message QBP^WOS and its Response RSP^WOS

3.7.4.1.1 Trigger Events

1315 The Pre/Post-processor refers one or more specimens by their ID or their position on its tray, and wants to obtain the corresponding specimen work order steps.

3.7.4.1.2 Message Semantics

3.7.4.1.2.1 QBP^WOS Static Definition

Table 3.7.4.1.2.1-1: QBP^WOS^QBP_Q11

Segment	Meaning	Usage	Card.	HL7 chapter
MSH	Message header	R	[1..1]	2
[{SFT}]	Software Segment	O	[0..*]	2
QPD	Query Parameter Definition	R	[1..1]	5
RCP	Response Control Parameter	R	[1..1]	5
[DSC]	Continuation Pointer	O	[0..1]	2

1320

MSH-9 - Message Type (MSG) shall have its two first components respectively valued to "QBP" and "Q11".

3.7.4.1.2.2 RSP^WOS Static Definition

Table 3.7.4.1.2.2-1: RSP^WOS^RSP_K11

Segment	Meaning	Usage	Card.	HL7 chapter
MSH	Message header	R	[1..1]	2
[{SFT}]	Software Segment	O	[0..*]	2
MSA	Message Acknowledgement	R	[1..1]	2
[ERR]	Error	O	[0..1]	2
QAK	Query Acknowledgement	R	[1..1]	5
QPD	Query Parameter Definition	R	[1..1]	5
{	--- SPECIMEN begin	C	[0..*]	
SPM	Specimen	R	[1..1]	7
[{OBX}]	Observation related to specimen	O	[0..*]	7
[{SAC}]	Specimen Container	RE	[0..1]	13
[--- PATIENT begin	O	[0..1]	
PID	Patient Identification	R	[1..1]	3
[{NTE}]	Notes and Comments (for Patient)	O	[0..*]	2
[{OBX}]	Observation related to the patient	O	[0..*]	7
]	--- PATIENT end			
{	--- ORDER begin	R	[1..1]	
ORC	Common Order	R	[1..1]	4
[{NTE}]	Notes and Comments (for Common Order)	O	[0..*]	2
[{TQ1}]	Timing/Quantity	RE	[0..1]	4
[--- OBSERVATION REQUEST begin	O	[0..1]	
OBR	Observation Request	R	[1..1]	4
[TCD]	Test Code Details	O	[0..1]	13
[{NTE}]	Notes and Comments (for ordered test code)	O	[0..*]	2
[{	--- OBSERVATION begin	O	[0..*]	
OBX	Observation/Result	R	[1..*]	7
[TCD]	Test Code Detail	O	[0..*]	13
[{ NTE }	Notes and Comments (for Results)	O	[0..*]	2
}]	--- OBSERVATION end			
]	--- OBSERVATION REQUEST end			
[{	--- PRIOR RESULT begin	O	[0..*]	
PV1	Patient Visit – previous result	R	[1..1]	3
{	--- ORDER PRIOR begin	R	[1*]	

Segment	Meaning	Usage	Card.	HL7 chapter
ORC	Common order – previous result	R	[1..1]	4
OBR	Order detail – previous result	R	[1..1]	4
{	--- OBSERVATION PRIOR begin	R	[1..*]	
OBX	Observation/Result – previous result	R	[1..1]	
[{NTE}]	Comment of the result	C	[0..*]	2
}	--- OBSERVATION PRIOR end			
}	--- ORDER PRIOR end			
}]	--- PRIOR RESULT end			
}	--- ORDER end			
}	--- SPECIMEN end			

1325

MSH-9 - Message Type (MSG) shall have its two first components respectively valued to "RSP" and "K11".

If the query was not based on the specimen ID, the response shall contain a SAC segment.

1330

The SPECIMEN segment group is not present in case of an erroneous query (e.g., barcode read error).

3.7.4.1.2.3 QPD Segment Static Definition

Table 3.7.4.1.2.3-1: QPD Segment Static Definition

SE Q	LEN	DT	Usage	Card.	TBL#	ITEM#	Element name
1	60	CE	R	[1..1]		01375	Message Query Name
2	32	ST	R	[1..1]		00696	Query Tag
3	80	EIP	C	[0..*]		01756	SPM-2:Specimen Identification
4	80	EI	C	[0..*]		01331	SAC-3:Container Identification
5	80	EI	C	[0..1]		01337	SAC-10:Carrier Identification
6	80	NA	C	[0..1]		01338	SAC-11:Position in Carrier
7	80	EI	C	[0..1]		01340	SAC-13:Tray Identification
8	80	NA	C	[0..1]		01341	SAC-14:Position in Tray
9	250	CE	C	[0..*]		01342	SAC-15:Location

1335

QPD-1 Message Query Name (CE), required.
Must be valued "WOS^Work Order Step^IHE_LABTF"

QPD-2 Query Tag (ST), required.

Unique to each query message instance.

QPD-3 Specimen Identification (EIP), conditional.

If this field is valued all other query fields shall be empty.

1340 **QPD-4 Container Identification (EI), conditional.**

Contains the identification of the container.

QPD-5 Carrier Identification (EI), conditional.

Contains the identification of the carrier (also known as Rack).

If this field is valued, then the field "QPD-6: Position in Carrier" shall also be valued.

1345 **QPD-6 Position in Carrier (NA), conditional.**
If these 2 fields (QPD-5,6) are valued all other query fields shall be empty, with the possible exception of the Location field (QPD-9).

QPD-7 Tray Identification (EI), conditional.

Contains the positions of the specimen/aliquot on the carrier (rack).

If this field is valued, then the field "QPD-5: Carrier Identification" shall also be valued.

1350 **QPD-8 Position in Tray (NA), conditional.**

Contains the identification of the Tray.

QPD-9 Location (CE), conditional.

Contains the position of the carrier on the tray.

1355 **QPD-9 Location (CE), conditional.**
Contains the physical location of the specimen.

This field cannot be valued in isolation, it must always be combined with the physical location/position of the specimen on either a carrier or a tray.

This field shall never be used in combination with either the specimen identification or the container identification fields.

1360 **3.7.4.1.2.4 RCP Segment Static Definition**

Table 3.7.4.1.2.4-1: RCP segment Static Definition

SEQ	LEN	DT	Usage	Card.		TBL#	ITEM#	Element name
1	1	ID	O	[0..1]		0091	00027	Query Priority
2	10	CQ	O	[0..1]		0126	00031	Quantity Limited Request
		NM						
		CE						
3	60	CE	O	[0..1]		0394	01440	Response Modality
7	256	ID	O	[0..*]			01594	Segment group inclusion

RCP-1 Query Priority(ID), optional. Fixed to "I" (=Immediate). If no value is given, the default is "I".

1365 RCP-2 Quantity Limited Request(CQ), optional. As for the 1st component "Quantity"(NM), Number of Records which will be returned in each increment of the response. If no value is given, the entire response will be returned in a single increment.
As for the 2nd component "Units"(CE), "RD"(=Records) is always set. If no value is given, the default is RD.

1370 RCP-3 Response Modality(CE), optional. Fixed to "R" (=Realtime). If no value is given, the default is "R".

RCP-7 Segment group inclusion(ID), optional. Specifies those optional segment groups which are to be included in the response. If this field is not valued, all segment groups will be included.

3.7.4.1.3 Expected Actions

Table 3.7.4.1.3-1: Expected Actions by Responder in [LAB-22]

Event	Initiator	Responder	Expected responder action
Query for SWOS. QBP message may have one or more Specimen IDs or Container IDs or locations.	Pre/Post-processor	Automation Manager	Look up for the SWOS corresponding to the specimen(s) of the query, and respond with this (these) SWOS. Even if the Automation Manager cannot find any SWOS for one or more IDs, the RSP message still has as many SPM segments as there were specimens in the query.

1375 3.7.5 Security Considerations

None.

3.8 Specimen Work Order Step Status Change [LAB-26]

3.8.1 Scope

1380 This transaction enables the Pre/Post Processor to notify the Automation Manager with the status of the performed specimen work order step (SWOS).

3.8.2 Actor Roles

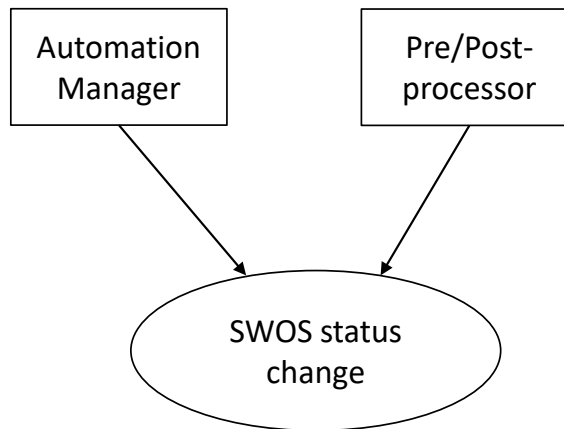

Figure 3.8.2-1: Use Case Diagram

Table 3.8.2-1: Actor Roles

Actor:	Pre/Post-processor
Role:	Performs a SWOS and notifies the Automation Manager with the status of execution.
Actor:	Automation Manager
Role:	Handles the sequence of SWOS

1385 3.8.3 Referenced Standards

HL7 version 2.5.1:

- Chapter 2: "Control" --> generic segments and data types
- Chapter 7: "Observation Reporting" --> SPM segment
- Chapter 13: "Clinical Laboratory Automation" --> SAC segment

1390 **3.8.4 Interaction Diagram**

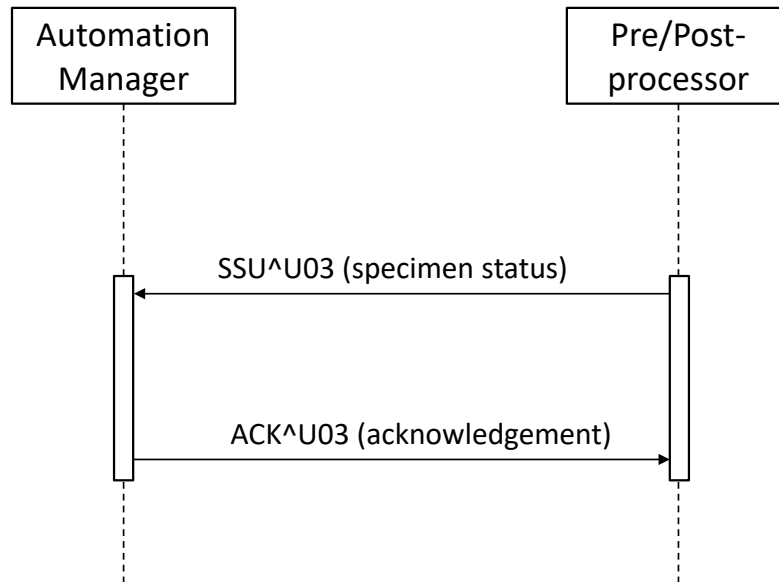

Figure 3.8.4-1: SWOS Status Change

3.8.4.1 Message SSU and its Acknowledgement

3.8.4.1.1 Trigger Events

1395 A SWOS is completed successfully or is terminated in error.

3.8.4.1.2 Message Semantics

3.8.4.1.2.1 SSU^U03 Static Definition

Table 3.8.4.1.2.1-1: SSU^U03 Static Definition^(Note 2)

Segment	Meaning	Usage	Card.	HL7 chapter
MSH	Message header	R	[1..1]	2
EQU	Equipment Detail	R	[1..1]	13
{	--- SPECIMEN_CONTAINER begin	R	[1..*]	
SAC	Specimen Container Detail	R	[1..1]	13
{ [OBX] }	Additional specimen characteristics	O	[0..*]	7
{ [NTE] }	Additional specimen container information ^(Note 1)	O	[0..*]	7
[{	--- SPECIMEN begin	O	[0..1]	
SPM	Specimen information	R	[1..1]	7
{ [OBX] }	Observation Result (for Specimen)	O	[0..*]	7
}]	--- SPECIMEN end			

Segment	Meaning	Usage	Card.	HL7 chapter
}	--- SPECIMEN_CONTAINER end			

Note 1: This segment is pre-adopted from HL7 v.2.8

1400

Note 2: The SSU message might appear too restrictive to meet future needs for carrying the output data of a SWOS, brought along by specific pre or post processing devices. If such a use case appears in the future for a specific device, alternative messages will be studied to extend this profile.

3.8.4.1.2.2 ACK^U03 Static Definition

1405

Table 3.8.4.1.2.2-1: ACK^U03 Static Definition

Segment	Meaning	Usage	Card.	HL7 chapter
MSH	Message header	R	[1..1]	2
MSA	Message Acknowledgement	R	[1..1]	2
[ERR]	Error	O	[0..1]	2

Field MSH-9 - Message Type (MSG) shall have its three components respectively valued to "ACK", "U03" and "ACK".

3.8.4.1.3 Expected Actions

1410

Table 3.8.4.1.3-1: Expected Actions by Responder in [LAB-26]

Event	Initiator	Responder	Expected responder action
SWOS completed or in error	Pre/Post-processor	Automation Manager	Store the information and acknowledges it.

3.8.5 Security Considerations

None.

Appendices

1415

See PaLM TF-2x.

1420

Glossary

1425 The IHE Glossary can be found as an appendix to the *IHE Technical Frameworks General Introduction* published [here](#).