

Integrating the Healthcare Enterprise



5

**IHE Eye Care
Technical Framework Supplement**

10

**Unified Eye Care Workflow
Refractive Measurements
Based upon JOIA 1.5 Release**

15

Rev. 1.2 – Trial Implementation

20 Date: June 29, 2016
Author: IHE Eye Care Technical Committee
Email: eyecare@ihe.net

25

Please verify you have the most recent version of this document. See [here](#) for Trial Implementation and Final Text versions and [here](#) for Public Comment versions.

Foreword

30 This is a supplement to the IHE Eye Care Technical Framework V4.0. Each supplement undergoes a process of public comment and trial implementation before being incorporated into the volumes of the Technical Frameworks.

This supplement is published on June 29, 2016 for trial implementation and may be available for testing at subsequent IHE Connectathons. The supplement may be amended based on the results of testing. Following successful testing it will be incorporated into the Eye Care Technical Framework. Comments are invited and can be submitted at
35 http://ihe.net/Eye_Care_Public_Comments.

This supplement describes changes to the existing technical framework documents.

“Boxed” instructions like the sample below indicate to the Volume Editor how to integrate the relevant section(s) into the relevant Technical Framework volume.

<i>Amend Section X.X by the following:</i>
--

40 Where the amendment adds text, make the added text **bold underline**. Where the amendment removes text, make the removed text **~~bold strikethrough~~**. When entire new sections are added, introduce with editor’s instructions to “add new text” or similar, which for readability are not bolded or underlined.

45 General information about IHE can be found at <http://ihe.net>.

Information about the IHE Eye Care domain can be found at http://ihe.net/IHE_Domains.

Information about the organization of IHE Technical Frameworks and Supplements and the process used to create them can be found at http://ihe.net/IHE_Process and <http://ihe.net/Profiles>.

50 The current version of the IHE Eye Care Technical Framework can be found at http://www.ihe.net/Technical_Frameworks.

CONTENTS

	Introduction to this Supplement.....	6
55	Open Issues and Questions	7
	Closed Issues.....	7
	History of Document Changes.....	7
	General Introduction	8
	Appendix A - Actor Summary Definitions.....	8
60	Appendix B - Transaction Summary Definitions	8
	Glossary	8
	Volume 1 – Integration Profiles.....	9
	Copyright Licenses.....	9
	Domain-specific additions	9
65	2.5 Actors Descriptions.....	9
	2.6 Transaction Descriptions.....	10
9	Unified EYE CARE Workflow (U-EYECARE).....	12
	9.1 U-EYECARE Actors and Transactions	14
	9.1.1 Patient Registration and Appointment Scheduling	15
70	9.1.2 Real World Model I - EHR Supports DICOM Worklist and Integrated with a PACS	15
	9.1.3 Real World Model II - EHR Supports DICOM Worklist, Image Storage and Display (With no PACS).....	15
75	9.1.4 Real World Model III - EHR Implements HL7 Only (no DICOM support) and Integrated with a PACS	15
	9.1.5 U-EYECARE Workflow with DICOM Options.....	15
	9.1.6 Refractive Measurements Model without Patient ID – Integrate refractive devices without Patient ID.....	15
	9.1.6.1 Real Life Example.....	17
80	9.1.7 Refractive Measurements Model with Patient ID – Integrate refractive devices with Valid Patient ID	18
	9.1.7.1 Real Life Example.....	20
	9.1.68 U-EYECARE Actor/Transaction Table	21
	9.1.79 Actor Descriptions and Actor Profile Requirements.....	23
85	9.1.-79.1 Real World Models.....	23
	9.2 U-EYECARE Actor Options	23
	9.2.1 Acquisition Modalities Storage Options	26
	9.2.9 Device Patient List Option	26
	9.3 U-EYECARE Actor Groupings	26
90	9.3.1 U-EYECARE Required Actor Groupings for Real World Models	26
	9.4 Unified Eye Care Workflow Process Flow	27
	9.4.7 Refractive Measurements Model without Patient ID.....	27
	9.4.8 Refractive Measurements Model with Valid Patient ID	29

	9.4.9 Device Patient List Option	30
95	9.5 Unified Eye Care Workflow Use Cases	32
	9.8 Refractive Measurements Use Case	32
	9.89 Unified Eye Care Workflow Security Considerations	33
	9.910 Unified Eye Care Cross-Profile Considerations	33
	Volume 2 – Transactions	34
100	4.23 Transfer Refractive Measurement (No Pat ID) [EYECARE-23]	35
	4.23.1 Scope	35
	4.23.2 Use Case Roles	35
	4.23.3 Referenced Standards	35
	4.23.4 Interaction Diagram	36
105	4.23.4.1 Transfer Refractive Measurement (No Pat ID)	36
	4.23.4.1.1 Trigger Events	36
	4.23.4.1.2 Message Semantics	36
	4.23.4.1.2.1 Common data Extensions	36
	4.23.4.1.2.2 Refractometer (REF) Clarifications	37
110	4.23.4.1.2.3 Tonometer (TM) Recommendations	37
	4.23.4.1.2.4 Lensmeter (REF) Clarifications	37
	4.23.4.1.2.5 Expected Action	37
	4.23.5 Transport Requirements	38
	4.23.6 Security Considerations	38
115	4.23.6.1 Security Audit Considerations	38
	4.24 Transfer Refractive Measurement (Valid Pat ID) [EYECARE-24]	38
	4.24.1 Scope	38
	4.24.2 Use Case Roles	38
	4.24.3 Referenced Standards	39
120	4.24.4 Interaction Diagram	39
	4.24.4.1 Transfer Refractive Measurement (Valid Pat ID)	39
	4.24.4.1.1 Trigger Events	39
	4.24.4.1.2 Message Semantics	40
	4.24.4.1.2.1 Common data Extensions	40
125	4.24.4.1.2.2 Refractometer (REG) Clarifications	40
	4.24.4.1.2.3 Tonometer (TM) Recommendations	40
	4.24.4.1.2.4 Lensmeter (LM) Extensions and Clarifications	40
	4.24.4.1.2.5 Expected Action	40
	4.24.5 Transport Requirements	41
130	4.24.6 Security Considerations	41
	4.24.6.1 Security Audit Considerations	41
	4.25 Query Patient List [EYECARE-25]	41
	4.25.1 Scope	41
	4.25.2 Use Case Roles	42
135	4.25.3 Referenced Standards	42
	4.25.4 Interaction Diagram	42

140

4.25.4.1 Query Patient List Message.....	42
4.25.4.1.1 Trigger Events	42
4.25.4.1.2 Message Semantics.....	43
4.25.4.1.2.1 Matching Keys and Return Keys for Display.....	43
4.25.4.1.3 Expected Action.....	46
4.25.5 Security Considerations.....	47
4.25.5.1 Security Audit Considerations.....	47

145 **Introduction to this Supplement**

150 The Unified Eye Care (U-EYECARE) Profile was added in 2015 and supports the ability to capture eye care images and measurements from many ophthalmic devices. However, it did not address an effective solution to import refractive device information into an EHR system. The IHE Eye Care domain adds this ability in this Trial Implementation Supplement to U-EYECARE by defining two additional real world models called Refractive Measurements Model without Patient ID and Refractive Measurements Model with Patient ID. These measurements are based upon the Japan Ophthalmic Instruments Association (JOIA) XML based specification. The Refractive Models added are:

- 155
- Refractive Measurements Model without Patient ID – Integrate refractive devices without Patient ID into an EHR
 - Refractive Measurements Model with Patient ID – Integrate refractive devices able to generate and/or capture a valid Patient ID into an EHR

Each supplement undergoes a process of public comment and trial implementation before being incorporated into the volumes of the Technical Frameworks.

160 This supplement is written as changes to the documents listed below. The reader should have already read and understood these documents:

1. [IHE Eye Care Technical Framework Volume 1, Integration Profiles](#)
2. [IHE Eye Care Technical Framework Volume 2, Transactions](#)

165 This supplement also references other documents¹. The reader should have already read and understood these documents:

1. [Radiology Technical Framework Volume 1, Integration Profiles](#)
2. [Radiology Technical Framework Volume 2, Transactions](#)
3. [Cardiology Technical Framework Volume 2, Transactions](#)
4. HL7^{®2} and DICOM^{®3} standards documents referenced in Volume 1 and Volume 2
- 170 5. [Common Specification for output data of Ophthalmic Examination Equipment 01 \(JOIA · STD.001-1.5 2016\)](#)

¹ The first three documents are located on the IHE Website at http://ihe.net/Technical_Frameworks/. The remaining documents can be obtained from their respective publishers.

² HL7 is the registered trademark of Health Level Seven International.

³ DICOM is the registered trademark of the National Electrical Manufacturers Association for its standards publications relating to digital communications of medical information.

Open Issues and Questions

No open issues.

Closed Issues

- 175 JOIA version 1.5 has included the requested IHE extensions and clarifications so such text has been removed from earlier versions of this Supplement.

History of Document Changes

This section provides a brief summary of changes and additions to this document.

Date	Document Revision	Change Summary
June 14, 2016	1.1 - Trail Implementation	First Release of U-EYECARE Refractive Profile, based upon JOIA 1.0 Release
June 29, 2016	1.2 - Change Proposal	Change Proposal that updates U-EYECARE Refractive Profile based upon JOIA 1.5 Release. JOIA 1.5 includes most of the extensions, constraints and clarifications recommended by IHE to version 1.0

180

185

General Introduction

190

Update the following Appendices to the General Introduction as indicated below. Note that these are not appendices to Volume 1.

Appendix A - Actor Summary Definitions

Add the following actors to the IHE Technical Frameworks General Introduction list of actors:

Actor	Definition
Refractive Measurement Source (RMS)	A system (such as an autorefractor, auto-keratometer, lensometer, etc.) that is able to generate standard based refractive measurements.
Refractive Measurement Consumer (RMC)	A system (such as an EHR) that is able to consume refractive measurements and import them into its database.
Refractive Measurement Source Importer (RMSI)	A system able to import refractive measurements (typically with a proprietary connection) and synchronize them with a valid patient identifier to generate standard refractive measurements.

Appendix B - Transaction Summary Definitions

195

Add the following transactions to the IHE Technical Frameworks General Introduction list of Transactions:

Transaction	Definition
Transfer Refractive Measurement (No Pat ID) – [EYECARE-23]	The transfer of eye care refractive measurement information based upon one or more JOIA specification data classifications. The data stream does NOT include a valid Patient ID; therefore, the Refractive Measurement Consumer is required to establish the context of the Patient before receiving the data stream from the Refractive Measurement Source. It uses the context to provide the correct patient information when importing the measurement(s) into its database.
Transfer Refractive Measurement (Valid Pat ID) – [EYECARE-24]	The transfer of eye care refractive measurement information based upon one or more JOIA specification data classifications. The data stream is required to include a valid Patient ID; therefore, the Refractive Measurement Consumer uses the Patient ID to identify the patient and to provide the correct patient information when importing the measurement(s) into its database.
Query Patient List [EYECARE-25]	This transaction provides the ability to obtain a list of patients (with associated patient demographics) that have arrived at the organization (e.g., checked into an eye care clinic). It is intended for acquisition devices (such as eye care refractive instruments, etc.) that are used for patient examinations, but are not based upon orders.

Glossary

200

Add the following glossary terms to the IHE Technical Frameworks General Introduction Glossary:

No glossary terms added.

Volume 1 – Integration Profiles

Copyright Licenses

NA

205 Domain-specific additions

NA

2.5 Actors Descriptions

Add descriptions for refractive measurement actors

210

Refractive Measurement Source (RMS) – A system (such as an autorefractor, auto-keratometer, lensometer, etc.) that is able to generate standard based refractive measurements.

Refractive Measurement Source Importer (RMSI) – A system able to import refractive measurements (typically with a proprietary connection) and synchronize them with a valid patient identifier to generate standard refractive measurements.

215

Refractive Measurement Consumer (RMC) – A system (such as an EHR) that is able to consume refractive measurements and import them into its database.

220

Add rows for refractive measurement actors

Table 2.5-1: Integration Profile Actors

Actor \ Integration Profile	Unified EYE CARE Workflow
Acquisition Modality	X
Acquisition Modality Importer	X
Appointment Scheduler	X
Appointment Consumer	X
Charge Processor	X
Department System Scheduler/Order Filler	X
Evidence Creator	X

Actor \ Integration Profile	Unified EYE CARE Workflow
Image Archive	X
Image Display	X
Image Manager	X
Image Storage/Display	X
Patient Registration Source	X
Patient Registration Consumer	X
Performed Procedure Step Manager	X
<u>Refractive Measurement Source</u>	<u>X</u>
<u>Refractive Measurement Source Importer</u>	<u>X</u>
<u>Refractive Measurement Consumer</u>	<u>X</u>
Report Creator	
Report Reader	
Report Repository	

2.6 Transaction Descriptions

Add descriptions for refractive measurement transactions

225

Transfer Refractive Measurement (No Pat ID) [EYECARE-23] – The transfer of eye care refractive measurement information based upon one or more JOIA specification data classifications. The data stream does NOT include a valid Patient ID; therefore, the Refractive Measurement Consumer is required to establish the context of the Patient before receiving the data stream from the Refractive Measurement Source. It uses the context to provide the correct patient information when importing the measurement(s) into its database.

230

Transfer Refractive Measurement (Valid Pat ID) [EYECARE-24] – The transfer of eye care refractive measurement information based upon one or more JOIA specification data classifications. The data stream is required to include a valid Patient ID; therefore, the Refractive Measurement Consumer uses the Patient ID to identify the patient and to provide the correct patient information when importing the measurement(s) into its database.

235

Query Patient List [EYECARE-25] - This transaction provides the ability to obtain a list of patients (with associated patient demographics) that have arrived at the organization (e.g., checked into an eye care clinic, etc.). It is intended for acquisition devices (such as eye care refractive instruments, etc.) that are used for patient examinations, but are not based upon orders.

240

Add new rows to Table 2.6-1 for refractive measurement transactions

245

Table 2.6-1: Integration Profile Transactions

Transaction	Integration Profile	Unified EYE CARE Workflow
Patient Encounter Management [ITI-31]		
Patient Registration [EYECARE-15]		X
Placer Order Management [RAD-2]		
Filler Order Management [RAD-3]		
Appointment Scheduling Management [EYECARE-16]		X
Procedure Scheduled [RAD-4]		
Procedure Scheduled [EYECARE-21]		X
Procedure Status Update [EYECARE-22]		X
Query Modality Worklist [EYECARE-1]		X
Modality Procedure Step In Progress [RAD-6]		X
Modality Procedure Step Completed [EYECARE-6]		X
Modality Images/Evidence Stored [EYECARE-2]		X
Modality Images/Evidence Key Objects Stored [EYECARE-18]		X
Storage Commitment [CARD-3]		X
Patient Update [RAD-12]		
Procedure Update [RAD-13]		
Patient Demographics Update [EYECARE-19]		X
Merge Patient IDs [EYECARE-20]		X
Query Images [EYECARE-5]		X
Retrieve Images [EYECARE-3]		X
Charge Posted [RAD-35]		
Eye Care Charge Posted [EYECARE-17]		X
Account Management [RAD-36]		
Query Evidence Documents [EYECARE-4]		
Retrieve Evidence Documents [RAD-45]		
Displayable Report Storage [EYECARE-7]		
Query Displayable Report [EYECARE-8]		
Retrieve Displayable Report [EYECARE-9]		
<u>Transfer Refractive Measurement (No Pat ID) – [EYECARE-23]</u>		
<u>Transfer Refractive Measurement (Valid Pat ID) – [EYECARE-24]</u>		
<u>Query Patient List [EYECARE-25]</u>		

Update EYECARE TF-1, Section 9 as follows:

9 Unified EYE CARE Workflow (U-EYECARE)

250 The Unified Eye Care Workflow (U-EYECARE) Integration Profile establishes the continuity and integrity of basic patient and procedure data in the context of an eye clinic workflow scenario. This profile deals specifically with consistent handling of patient identifiers and demographic data. It specifies the scheduling and coordination of procedure data to a wide variety of diagnostic imaging and testing equipment and the ability to post eye care charges.

255 This Unified Eye Care Workflow Profile takes the best features of previously defined workflows (which are now retired), combines them into one workflow profile, and provides more flexibility for three real world implementation models for systems such as EHRs and PACS.

An overview of the features is:

- **Patient Registration and Appointment Scheduling:**

260

- These messages are typically sent between Practice Management Systems (PMS) and EHRs. Patient registration and updates to patient demographic data are based upon HL7 ADT messages (A04 and A08). Management of patient appointment data (i.e., new appointments, confirmed appointments, patient checked in, cancelled, deleted, etc.) is based upon HL7 SIU messages.

265

- All HL7 messages in U-EYECARE utilize HL7 v2.5.1.

265

- Optional features include merging patient IDs and the ability to post billing charges.

265

- The patient registration and appointments workflow is the same for all real world implementation models.

265

- See Sections 9.1.1 and 9.4.1.

270

- Real World Model I - EHR Implements DICOM Modality Worklist and Integrates with a PACS:

275

- Real World Model I addresses a scenario where organizations have a Practice Management System (PMS), Electronic Health Record System (EHR), centralized Image Archive, Image Display (PACS) and eye care diagnostic imaging and testing equipment (fundus cameras, slit lamps, refractive measurement devices, visual fields etc.).

275

- This model specifies the transactions and actors required for the scenario where the DSS/Order Filler (i.e., typically an EHR) supports DICOM Modality Worklist and is integrated with the Image Manager/Image Archive (i.e., typically a PACS).

275

- See Sections 9.1.2 and 9.4.2.

280

- Real World Model II - EHR Implements DICOM Modality Worklist, Image Storage and Display (With no PACS):

- 285 • Real World Model II addresses a scenario where organizations have a Practice Management System (PMS), Electronic Health Record System (EHR) and eye care diagnostic imaging and testing equipment (fundus cameras, slit lamps, refractive measurement devices, visual fields etc.). The EHR performs the storage (not archive) and display of DICOM images, measurements, etc.
- 290 • This model reduces the PACS implementation requirements of the other eye care workflows by not integrating an Image Archive (i.e., PACS system) and places more responsibility on the EHR and acquisition devices. **Therefore, users of this model must understand that acquisition devices and users are responsible for the safe keeping of the images and/or measurements created upon their system. It is important for users to determine how this is accomplished so that patient data is protected.** How this is accomplished is outside the scope of IHE.
- 295 • This model specifies the transactions and actors required for the scenario where the DSS/Order Filler (i.e., typically an EHR) supports DICOM Modality Worklist, Image Storage and Display. Real World Model II does not include an Image Manager/Image Archive (i.e., a PACS system). Acquisition Modality Actors (i.e., eye care instruments) have the requirement to send selective images and/or measurements.
- See Sections 9.1.3 and 9.4.3.
- 300 • **Real World Model III - EHR Implements HL7 Only (no DICOM support) and Integrates with a PACS:**
 - 305 • Real World Model III addresses a scenario where organizations have a Practice Management System (PMS), Electronic Health Record System (EHR), centralized Image Archive, Image Display (PACS) and eye care diagnostic imaging and testing equipment (fundus cameras, slit lamps, refractive measurement devices, visual fields, etc.).
 - 310 • This model specifies the transactions and actors required for the scenario where the DSS/Order Filler (i.e., typically an EHR) does not support DICOM and only implements HL7 messages. Therefore, the Image Manager/Image Archive supports DICOM Modality Worklist. All messages utilize HL7 v2.5.1.
 - See Sections 9.1.4 and 9.4.4.
- **Optional Transactions:**
 - 315 • Some transactions, such as those based upon DICOM Modality Performed Procedure Step, DICOM Storage Commitment, are optional for actors in U-EYECARE.

Add new bullets for refractive models

- **Refractive Measurements Model without Patient ID:**

320 **Refractive Measurements Model without Patient ID addresses a scenario where organizations have a Practice Management System (PMS), Electronic Health Record System (EHR) and refractive measurement devices.**

325 **This model specifies the transactions and actors required for the scenario where organizations are integrating refractive measurement devices that are unable to incorporate a valid Patient ID when providing refractive measurements to their EHR system. Therefore, the Refractive Measurement Consumer (typically an EHR) is required to establish the context of the patient before receiving the data stream from the Refractive Measurement Source. Refractive measurements are conveyed using the Japan Ophthalmic Instruments Association (JOIA) XML based specification. Example devices include autorefractors, auto-keratometers, lensometers, etc.**

330

See Sections 9.1.6 and 9.4.7.

- **Refractive Measurements Model with Patient ID:**

335 **Refractive Measurements Model with Patient ID addresses a scenario where organizations have a Practice Management System (PMS), Electronic Health Record System (EHR) and refractive measurement devices.**

340 **This model specifies the transactions and actors required for the scenario where organizations are integrating refractive measurement devices that are able to incorporate a valid Patient ID when providing refractive measurements to their EHR system. Therefore, the Refractive Measurement Consumer (typically an EHR) is required to use the Patient ID provided by the Refractive Measurement Source or by a Refractive Measurement Source Importer to establish the context of the patient. Refractive measurements are conveyed using the Japan Ophthalmic Instruments Association (JOIA) XML based specification. Example devices include autorefractors, auto-keratometers, lensometers, etc.**

345

350 **See Sections 9.1.7 and 9.4.8.**

9.1 U-EYECARE Actors and Transactions

This section defines the actors, transactions, and/or content modules in this profile. General definitions of actors are given in the Technical Frameworks General Introduction Appendix A at http://ihe.net/Technical_Frameworks/.

355

9.1.1 Patient Registration and Appointment Scheduling

.....

9.1.2 Real World Model I - EHR Supports DICOM Worklist and Integrated with a PACS

360

9.1.3 Real World Model II - EHR Supports DICOM Worklist, Image Storage and Display (With no PACS)

.....

9.1.4 Real World Model III - EHR Implements HL7 Only (no DICOM support) and Integrated with a PACS

.....

365

9.1.5 U-EYECARE Workflow with DICOM Options

.....

370

Add Sections 9.1.6, 9.1.7 and subsections for refractive models, text and figures for actors and transactions and update section numbering.

Note that Vol 1 FT already contains these section numbers, so they are renumbered below.

9.1.6 Refractive Measurements Model without Patient ID – Integrate refractive devices without Patient ID

375 Refractive Measurements Model without Patient ID addresses a scenario where organizations have a Practice Management System (PMS), Electronic Health Record System (EHR) and refractive measurement devices.

380 This model specifies the transactions and actors required for the scenario where organizations are integrating refractive measurement devices that are unable to incorporate a valid Patient ID when providing refractive measurements to their EHR system. Therefore, the Refractive Measurement Consumer (typically an EHR) is required to establish the context of the patient before receiving the data stream from the Refractive Measurement Source. It uses the context to provide correct patient information when importing the measurement(s) into its database. Refractive measurements are conveyed using the JOIA XML based specification. Example devices include
385 autorefractors, auto-keratometers, lensometers, etc.

Figure 9.1.6-1 shows the actors directly involved in the U-EYECARE Profile relevant to this refractive model (no Pat ID). Only required transactions are shown, optional transactions have been omitted from the diagram.

390

Note: Organizations may have other systems such as PACS, display stations, other eye care devices, etc. However, these actors are not part of the refractive models.

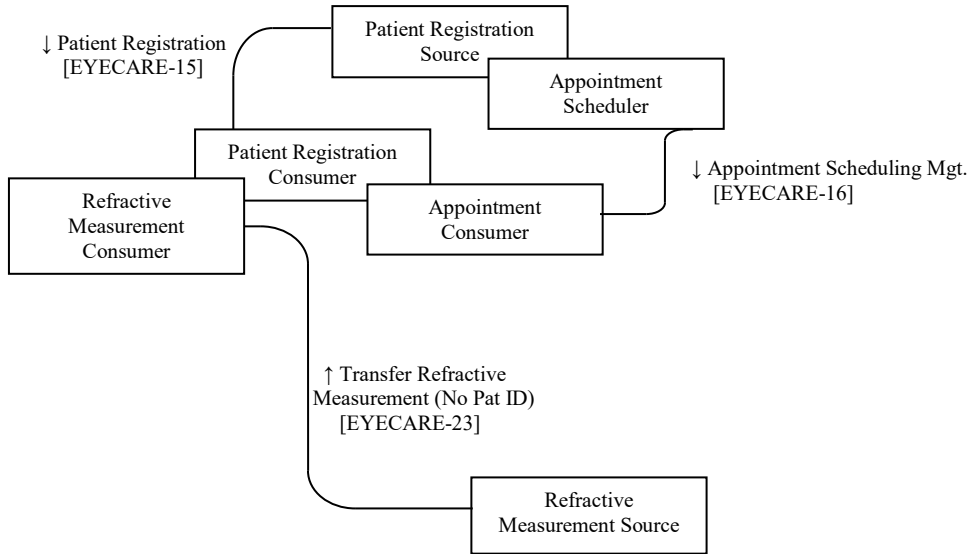

Figure 9.1.6-1: Refractive Measurement Model (No Pat ID) - Workflow Diagram

395

IHE Eye Care does not specify real world systems that implement IHE actors. However, certain actors (and/or combination of actors) often make sense for specific products. For example, a Practice Management System (PMS) real world product may be the type of system that implements the Patient Registration Source and Appointment Scheduler Actors. An Electronic Health Record (EHR) real world product may be the type of system that implements the Patient Registration Consumer, Appointment Consumer, Refractive Measurement Consumer Actors (see Figure 9.1.6-2).

400

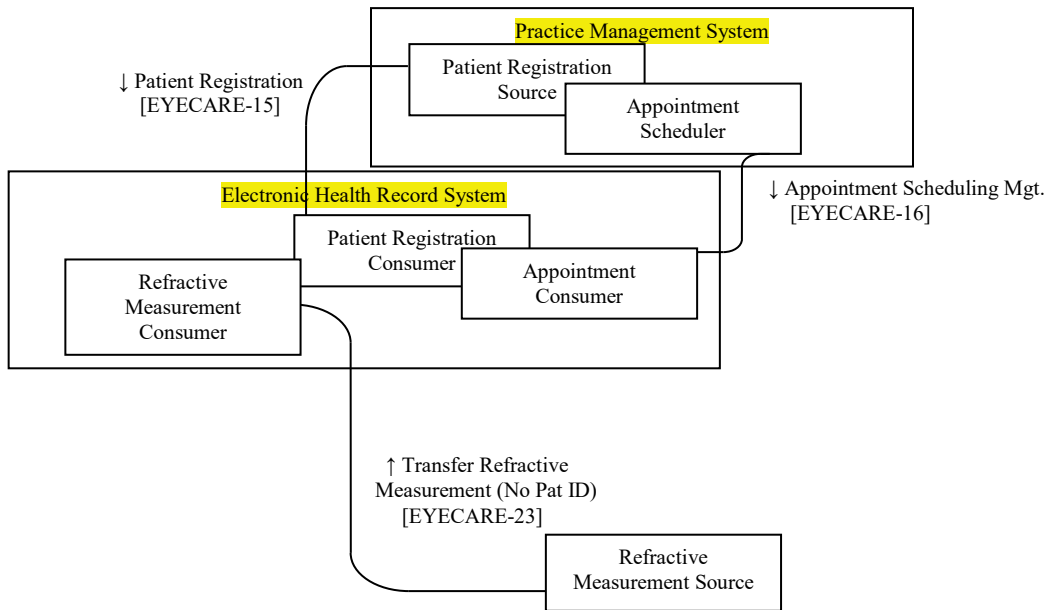

Figure 9.1.6-2: (Informative) Actors Mapping to Real World Systems

9.1.6.1 Real Life Example

405 Refractive measurement devices typically last for many years therefore devices may not have the
 ability to conform to the JOIA XML specification. They are only capable of transmitting
 measurement data in a proprietary format. This requires that the instrument's measurement data
 be transmitted to an intermediary, a software application that captures the instrument's
 measurement data (in a proprietary format) and translates it into a standardized message format
 410 before transferring it to the target.

Figure 9.1.6.1-1 shows that the Refractive Measurement Source consists of the refractive
 measurement instrument and a measurement data translator (the capture/translation program).
 This actor is typically implemented by connecting the instrument to a computer workstation
 running the capture/translation program. The output of the Refractive Measurement Source is a
 415 Transfer Refractive Measurement (No Pat ID) [EYECARE-23] transaction which is transferred
 to the Refractive Measurement Consumer.

Since neither the instrument nor the capture/translation program have access to patient
 information, the capture/translation program will set the <PatientIDSource> field in the JOIA
 XML data stream to "unreliable" in order to notify the Refractive Measurement Consumer (target
 420 system or instrument) of that fact. The Refractive Measurement Consumer is required to
 associate the received measurement data with a specific patient session (an appointment or
 examination). The Refractive Measurement Consumer can only accept this measurement data if
 a valid patient session context exists for the data.

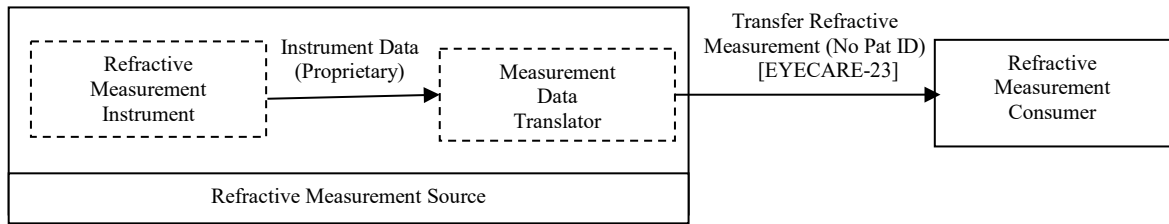

425 **Figure 9.1.6.1-1: (Informative) Refractive Measurement Source Example**

9.1.7 Refractive Measurements Model with Patient ID – Integrate refractive devices with Valid Patient ID

430 Refractive Measurements Model with Patient ID addresses a scenario where organizations have a Practice Management System (PMS), Electronic Health Record System (EHR) and refractive measurement devices.

435 This model specifies the transactions and actors required for the scenario where organizations are integrating refractive measurement devices that are able to incorporate a valid Patient ID when providing refractive measurements to their EHR system. The Refractive Measurement Source could accomplish this directly or by a Refractive Measurement Source Importer. Therefore, the Refractive Measurement Consumer (typically an EHR) is required to use the Patient ID provided by the Refractive Measurement Source or a Refractive Measurement Source Importer to establish the context of the patient. It uses the context to provide the correct patient information when importing the measurement(s) into its database. Refractive measurements are conveyed using the JOIA XML based specification. Example devices include autorefractors, auto-
440 keratometers, lensometers, etc.

Figure 9.1.7-1 shows the actors directly involved in the U-EYECARE Profile relevant to this refractive model (no Pat ID). Only required transactions are shown, optional transactions have been omitted from the diagram.

445 Note: Organizations may have other systems such as PACS, display stations, other eye care devices, etc. However, these actors are not part of the refractive models.

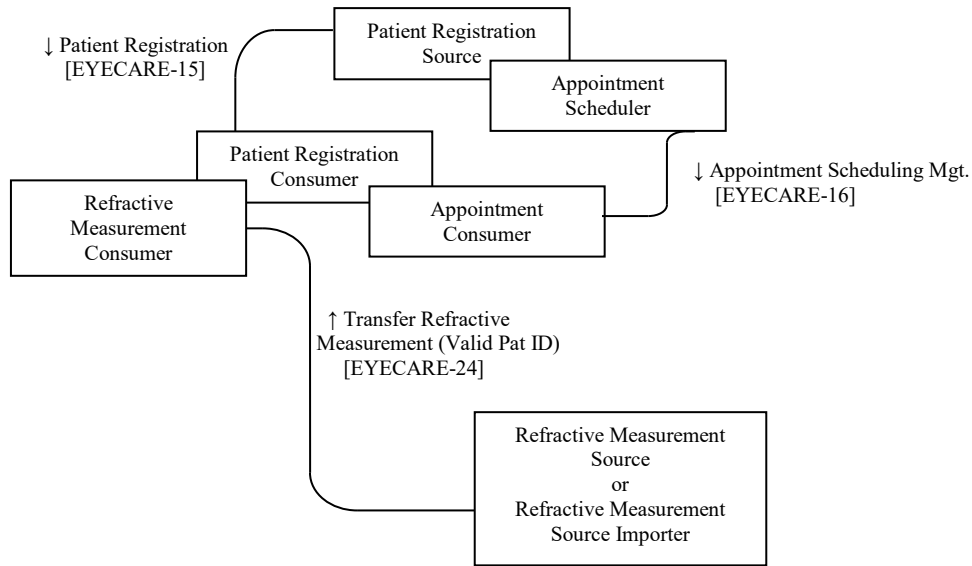

Figure 9.1.7-1: Refractive Measurement Model (Valid Pat ID) - Workflow Diagram

IHE Eye Care does not specify real world systems that implement IHE actors. However, certain actors (and/or combination of actors) often make sense for specific products. For example, a Practice Management System (PMS) real world product may be the type of system that implements the Patient Registration Source and Appointment Scheduler Actors. An Electronic Health Record (EHR) real world product may be the type of system that implements the Patient Registration Consumer, Appointment Consumer, Refractive Measurement Consumer Actors (see Figure 9.1.7-2).

455

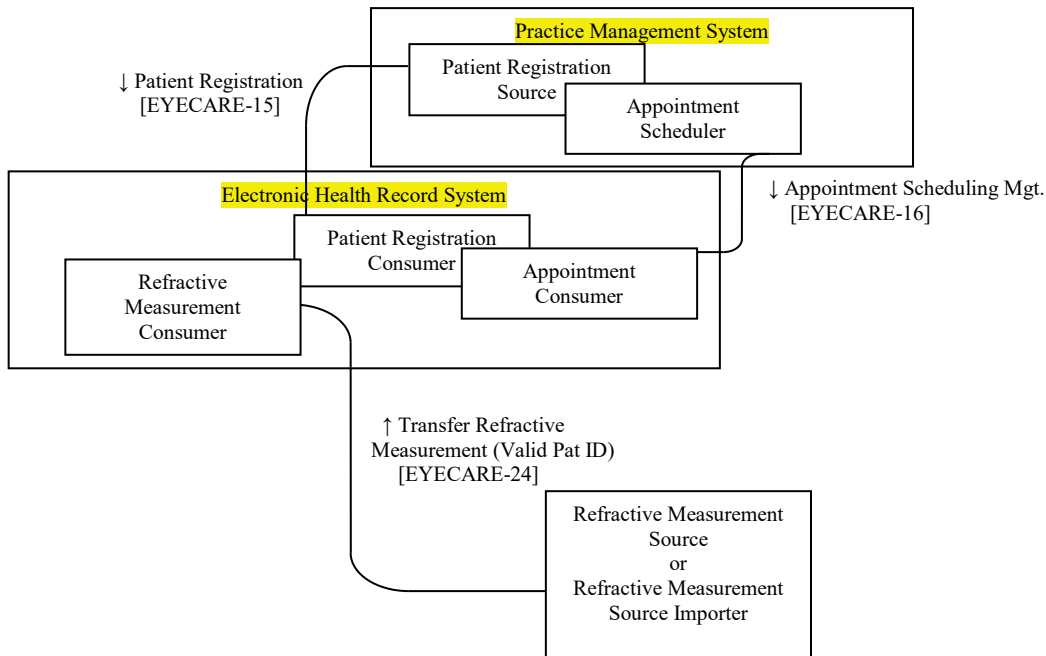

Figure 9.1.7-2: (Informative) Actors Mapping to Real World Systems

9.1.7.1 Real Life Example

460 Refractive measurement devices typically last for many years therefore devices may not have the ability to conform to the JOIA XML specification. They are only capable of transmitting measurement data in a proprietary format. This requires that the instrument's measurement data be transmitted to an intermediary, a software application that captures the instrument's measurement data (in a proprietary format) and translates it into a standardized message format before transferring it to the target. If the software application is able to capture the valid Patient ID, the software application is a Refractive Measurement Source Importer.

470 Figure 9.1.7.1-1 shows that the Refractive Measurement Source consists of the refractive measurement instrument and a Refractive Measurement Source Importer (the capture/translation program). This actor is typically implemented by connecting the instrument to a computer workstation running the capture/translation program. The output of the Refractive Measurement Source is a Transfer Refractive Measurement (Valid Pat ID) [EYECARE-24] transaction which transfers refractive measurement data to the Refractive Measurement Consumer.

475 Since the capture/translation program has access to patient information, the Refractive Measurement Source Importer will set the <PatientIDSource> field in the JOIA XML data stream to "manual", "auto device" or "auto patient list" in order to notify the Refractive Measurement Consumer (target system or instrument) of that fact. The Refractive Measurement Consumer uses the Patient ID in the data stream to associate the received measurement data with a specific patient.

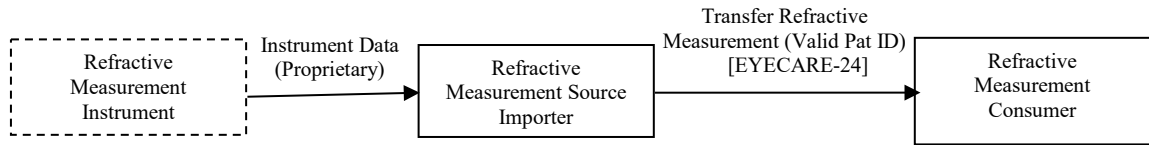

Figure 9.1.7.1-1: (Informative) Refractive Measurement Source Importer Example

480 *Renumber the sections and table as follows, and update the Actor/Transaction Table to add columns for for Refractive Measurement Models (and update section numbering)*

9.1.68 U-EYECARE Actor/Transaction Table

485 Table 9.1.68-1 lists the transactions for each actor directly involved in the U-EYECARE Profile. To claim compliance with this profile, an actor SHALL support all required transactions (labeled “R”) and may support the optional transactions (labeled “O”).

Table 9.1.68-1: Unified Eye Care Workflow – Actors and Transactions

Actors	Transactions	Model I	Model II	Model III	Refract Meas (no Pat ID)	Refract Meas (valid Pat ID)	Section
		Transaction Optionality					
Patient Registration Source	Patient Registration [EYECARE-15]	R	R	R	<u>R</u>	<u>R</u>	EYECARE TF-2: 4.15
Appointment Scheduler	Appointment Scheduling Management [EYECARE-16]	R	R	R	<u>R</u>	<u>R</u>	EYECARE TF-2: 4.16
Patient Registration Consumer	Patient Registration [EYECARE-15]	R	R	R	<u>R</u>	<u>R</u>	EYECARE TF-2: 4.15
Appointment Consumer	Appointment Scheduling Management [EYECARE-16]	R	R	R	<u>R</u>	<u>R</u>	EYECARE TF-2: 4.16
Department System Scheduler/ Order Filler	Patient Demographics Update [EYECARE-19]	R		R			EYECARE TF-2: 4.19
	Query Modality Worklist [EYECARE-1]	R	R				EYECARE TF-2: 4.1
	Procedure Scheduled [EYECARE-21]	R		R			EYECARE TF-2: 4.21
<u>Refractive Measurement Consumer</u>	<u>Transfer Refractive Measurement (No Pat ID) – [EYECARE-23]</u>				<u>R</u>		<u>EYECARE TF-2: 4.23</u>

IHE Eye Care Technical Framework Supplement – Unified Eye Care Workflow Refractive Measurements

Actors	Transactions	Model I	Model II	Model III	Refract Meas (no Pat ID)	Refract Meas (valid Pat ID)	Section
		Transaction Optionality					
	<u>Transfer Refractive Measurement (Valid Pat ID) – [EYECARE-24]</u>					<u>R</u>	<u>EYECARE TF-2: 4.24</u>
Image Manager/ Image Archive <i>(Not an actor for Model II)</i>	Procedure Scheduled [EYECARE-21]	R		R			EYECARE TF-2: 4.21
	Patient Demographics Update [EYECARE-19]	R		R			EYECARE TF-2: 4.19
	Query Modality Worklist [EYECARE-1]			R			EYECARE TF-2: 4.1
	Modality Images/Evidence Stored [EYECARE-2]	R		R			EYECARE TF-2: 4.2
	Query Images [EYECARE-5]	R		R			EYECARE TF-2: 4.5
	Retrieve Images [EYECARE-3]	R		R			EYECARE TF-2: 4.3
Image Storage/Display <i>(Only required in Model II)</i>	Modality Images/Evidence Key Objects Stored [EYECARE-18]		R				EYECARE TF-2: 4.18
Image Display <i>(Not an actor for Model II)</i>	Query Images [EYECARE-5]	R		R			EYECARE TF-2: 4.5
	Retrieve Images [EYECARE-3]	R		R			EYECARE TF-2: 4.3
Acquisition Modality	Query Modality Worklist [EYECARE-1]	R	R	R			EYECARE TF-2: 4.1
	Modality Images/Evidence Stored [EYECARE-2]	R		R			EYECARE TF-2: 4.2
	Modality Images/Evidence Key Objects Stored [EYECARE-18]		R				EYECARE TF-2: 4.18
Acquisition Modality Importer	Query Modality Worklist [EYECARE-1]	R	R	R			EYECARE TF-2: 4.1
	Modality Images/Evidence Stored [EYECARE-2]	R		R			EYECARE TF-2: 4.2
	Modality Images/Evidence Key Objects Stored [EYECARE-18]		R				EYECARE TF-2: 4.18
<u>Refractive Measurement Source</u>	<u>Transfer Refractive Measurement (No Pat ID) – [EYECARE-23]</u>				<u>R</u>		<u>EYECARE TF-2: 4.23</u>
	<u>Transfer Refractive Measurement (Valid Pat ID) – [EYECARE-24]</u>					<u>R</u>	<u>EYECARE TF-2: 4.24</u>
<u>Refractive Measurement Source Importer</u>	<u>Transfer Refractive Measurement (Valid Pat ID) – [EYECARE-24]</u>					<u>R</u>	<u>EYECARE TF-2: 4.24</u>

Actors	Transactions	Model I	Model II	Model III	Refract Meas (no Pat ID)	Refract Meas (valid Pat ID)	Section
		Transaction Optionality					
Charge Processor	Eye Care Charge Posted [EYECARE-17]	R	R	R			EYECARE TF-2: 4.17
Evidence Creator	Modality Images/Evidence Stored [EYECARE-2]	R		R			EYECARE TF-2: 4.2
Performed Procedure Step Manager	Modality Procedure Step In Progress [RAD-6]	R					RAD TF-2: 4.6
	Modality Procedure Step Completed [EYECARE-6]	R					RAD TF-2: 4.7

Note 1: An EHR real world product may be the type of system that implements the Patient Registration Consumer, Appointment Consumer and Department System Schedule/Order Filler Actors and possibly the Image Storage/Display.

490

Note 2: A PMS real world product may be the type of system that implements the Patient Registration Source, Appointment Scheduler and Charge Processor Actors.

9.1.79 Actor Descriptions and Actor Profile Requirements

Most requirements are documented in Transactions (Volume 2) and Content Modules (Volume 3). This section documents any additional requirements on profile's actors and Real World Models.

495

9.1.79.1 Real World Models

All actors in U-EYECARE SHALL support their required transactions for one or more Real World Models.

500

Update Actor Options for Refractive Measurement Models

9.2 U-EYECARE Actor Options

Options that may be selected for each actor in this profile, if any, are listed in Table 9.2-1. Dependencies between options when applicable are specified in notes. IHE does not place any restrictions on which options are supported for any of the Real World Models **or Refractive Measurement Models**; however, some options do not make sense. For example, in Real World Model III the DSS/Order Filler does not support DICOM; therefore, the optional transactions related to DICOM are not relevant.

505

510

Table 9.2-1: Unified Eye Care Workflow - Actors and Options

Actor	Option Name	Reference
Patient Registration Source	Patient Record Merging Option	EYECARE TF-1: 9.2.2
Appointment Scheduler	<i>No options defined</i>	--
Charge Processor	<i>No options defined</i>	--
Patient Registration Consumer	Patient Record Merging Option	EYECARE TF-1: 9.2.2
Appointment Consumer	<i>No options defined</i>	--
Department System Scheduler/Order Filler	Patient Record Merging Option	EYECARE TF-1: 9.2.2
	Imaging Procedure Instructions Option	EYECARE TF-1: 9.2.3
	Imaging Procedure Status Update (DICOM) Option	EYECARE TF-1: 9.2.4
	Imaging Procedure Status Update (HL7) Option	EYECARE TF-1: 9.2.5
	Charge Posting Option	EYECARE TF-1: 9.2.7
<u>Refractive Measurement Consumer</u>	<u>Device Patient List Option</u>	<u>EYECARE TF-1: 9.2.9</u>
Image Manager/ Image Archive	Patient Record Merging Option	EYECARE TF-1: 9.2.2
	Eye Care Image Option	EYECARE TF-1: 9.2.1.1
	Encapsulated PDF Option for Evidence Documents	EYECARE TF-1: 9.2.1.2
	Eye Care Measurements Option	EYECARE TF-1: 9.2.1.3
	Imaging Procedure Status Update (DICOM) Option	EYECARE TF-1: 9.2.3
	Imaging Procedure Status Update (HL7) Option	EYECARE TF-1: 9.2.5
	Storage Commitment Option	EYECARE TF-1: 9.2.6
	PACS Key Images Sent Option	EYECARE TF-1: 9.2.8
	Stereo Relationship Option	EYECARE TF-1: 39.2.1.5
	Imaging Procedure Instructions Option	EYECARE TF-1: 9.2.3
Image Display	Eye Care Image Option	EYECARE TF-1: 9.2.1.1
	Encapsulated PDF Option for Evidence Documents	EYECARE TF-1: 9.2.1.2
	Relative Image Position Coding Option	EYECARE TF-1: 3.2.2 EYECARE TF-2: 4.3.6

IHE Eye Care Technical Framework Supplement – Unified Eye Care Workflow Refractive Measurements

Actor	Option Name	Reference
	Stereo Relationship Option	EYECARE TF-1: 9.2.1.5
Image Storage/Display <i>(an optional actor in Model I and III)</i>	Eye Care Image Option	EYECARE TF-1: 9.2.1.1
	Encapsulated PDF Option for Evidence Documents	EYECARE TF-1: 9.2.1.2
	PACS Key Images Sent Option	EYECARE TF-1: 9.2.8
	Eye Care Measurements Option	EYECARE TF-1: 9.2.1.3
Evidence Creator	Storage Commitment Option	EYECARE TF-1: 9.2.6
Acquisition Modality	Patient Based Worklist Query Option (see Note 1)	EYECARE TF-2: 4.1
	Broad Worklist Query Option (see Note 1)	EYECARE TF-2: 4.1
	Eye Care Image Option (see Note 2)	EYECARE TF-1: 9.2.1.1
	Encapsulated PDF Option for Evidence Documents (see Note 2)	EYECARE TF-1: 9.2.1.2
	Eye Care Measurement Option	EYECARE TF-1: 9.2.1.3
	Imaging Procedure Status Update (DICOM) Option	EYECARE TF-1: 9.2.4
	Storage Commitment Option	EYECARE TF-1: 9.2.6
	Relative Image Position Coding Option	EYECARE TF-1: 3.2.2
	Stereo Relationship Option	EYECARE TF-1: 9.2.1.5
	Imaging Procedure Instructions Option	EYECARE TF-1: 9.2.3
Acquisition Modality Importer	Patient Based Worklist Query Option (see Note 1)	EYECARE TF-2: 4.1
	Broad Worklist Query Option (see Note 1)	EYECARE TF-2: 4.1
	Eye Care Measurement Option	EYECARE TF-1: 9.2.1.3
	Eye Care Image Option (see Note 2)	EYECARE TF-1: 9.2.1.1
	Encapsulated PDF Option for Evidence Documents (see Note 2)	EYECARE TF-1: 9.2.1.2
	Imaging Procedure Status Update (DICOM) Option	EYECARE TF-1: 9.2.4
	Storage Commitment Option	EYECARE TF-1: 9.2.6
	Relative Image Position Coding Option	EYECARE TF-1: 3.2.2
	Stereo Relationship Option	EYECARE TF-1: 9.2.1.5
	Imaging Procedure Instructions Option	EYECARE TF-1: 9.2.3 EYECARE TF-2: 4.1.6
<u>Refractive Measurement Source</u>	<u>Device Patient List Option</u>	<u>EYECARE TF-1: 9.2.9</u>
<u>Refractive Measurement Source Importer</u>	<u>Device Patient List Option</u>	<u>EYECARE TF-1: 9.2.9</u>
Performed Procedure Step Manager	<i>No options defined</i>	--

Note 1: The Radiology TF requires that the Acquisition Modality support at least one of the Worklist Query Options (i.e., Patient-Based or Broad). Eye Care requires Acquisition Modality and Acquisition Modality Importer Actors to support BOTH the Patient-Based and Broad Worklist Query Options.

515

Note 2: The Acquisition Modality and Acquisition Modality Importer Actors SHALL support either the Eye Care Image Option or the Encapsulated PDF Option for Evidence Documents.

9.2.1 Acquisition Modalities Storage Options

.. ... Many options

Add option for Patient List

520

9.2.9 Device Patient List Option

This option allows actors (e.g., Refractive Measurement Source and Refractive Measurement Source Importer) to obtain a list of patients (with associated patient demographics) that have arrived at the organization (e.g., checked into an eye care clinic).

525

This transaction uses DICOM Modality Worklist (DICOM MWL). DICOM MWL is based upon patient and orders, however, only the patient attributes of DICOM MWL are of interest. It is intended for acquisition devices (such as eye care refractive instruments) that are used for patient examinations, but are not based upon orders.

530

A Refractive Measurement Source or Refractive Measurement Source Importer or Refractive Measurement Consumer that support this option SHALL support the Query Patient List [EYECARE-25] transaction.

Update table 9.3.1 for Refractive Measurement Grouping

535

9.3 U-EYECARE Actor Groupings

9.3.1 U-EYECARE Required Actor Groupings for Real World Models

Table 9.3-1: U-EYECARE - Required Actor Groupings

U-EYECARE Actor	U-EYECARE Actor to be grouped with
Patient Registration Source (Note 1)	Appointment Scheduler
Appointment Scheduler	Patient Registration Source
Charge Processor	Patient Registration Source
	Appointment Scheduler
Patient Registration Consumer	Appointment Consumer

U-EYECARE Actor	U-EYECARE Actor to be grouped with
	Department System Scheduler/Order Filler
Appointment Consumer	Department System Scheduler/Order Filler
	Patient Registration Consumer
Department System Scheduler/Order Filler	Patient Registration Consumer
	Appointment Consumer
<u>Refractive Measurement Consumer</u>	<u>Patient Registration Consumer</u>
Image Storage/Display	Department System Scheduler/Order Filler
	Patient Registration Consumer
	Appointment Consumer
Acquisition Modality	None
Acquisition Modality Importer	None
<u>Refractive Measurement Source</u>	<u>None</u>
<u>Refractive Measurement Source Importer</u>	<u>None</u>

Note 1: There are optional groupings specified to support Charge Posting. See Section 9.2.7.

Add new sections for Refractive Measurement Process Flows

9.4 Unified Eye Care Workflow Process Flow

.....

545 9.4.7 Refractive Measurements Model without Patient ID

Refractive Measurements Model without Patient ID addresses a scenario where organizations have a Practice Management System (PMS), Electronic Health Record System (EHR) and refractive measurement devices.

550 This model specifies the Eye Care administrative process flow relevant to the scenario were the Refractive Measurement Source is *not* able to provide a valid Patient ID in the JOIA XML data stream. The Refractive Measurement Consumer (typically an EHR) is required to establish the context of the patient before receiving the data stream from the Refractive Measurement Source. The process flow is shown in Figure 9.4.7-1. The functionality of those data flows is specified within the specific transactions.

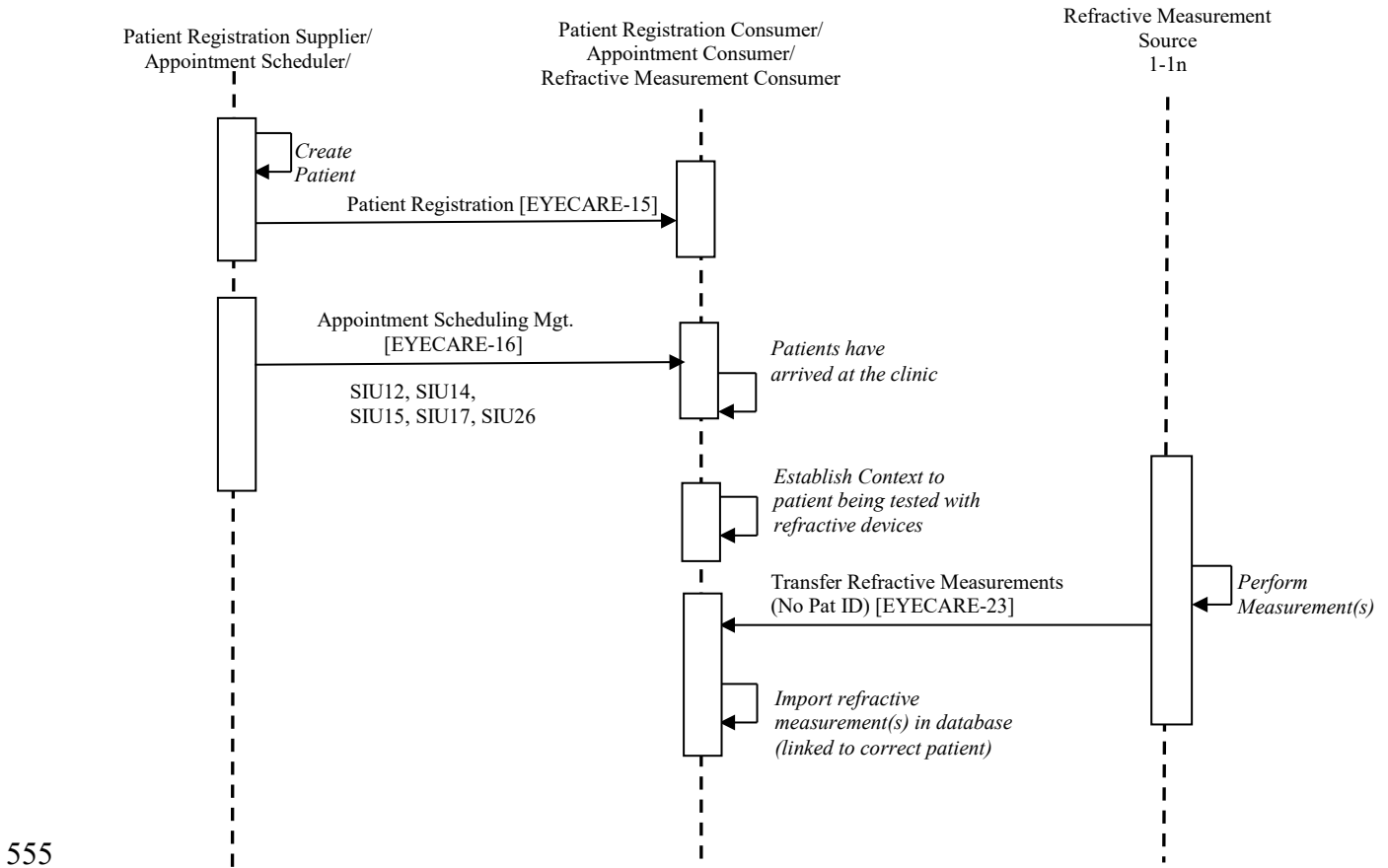

555 **Figure 9.4.7-1: Refractive Measurements Model without Patient ID - Administrative Process Flow**

- **Patient Registration:** New patient demographics and updates are sent to consuming systems.
- 560 • **Appointment Scheduling:** The patient’s appointment is created/managed and sent to consuming systems. This includes new appointments, updates such as confirmed, arrived, checked in, complete. It also supports cancel/delete appointments and patient no shows.
- 565 • **Establish Patient Context:** The Refractive Measurement Consumer (RMC) creates context for the patient being tested for refractive measurements. How this is accomplished is outside the scope of IHE.
- **Perform Measurements:** Each Refractive Measurement Source (RMS) creates one or more types of refractive measurements (keratometry, lensometry and refractive, etc.). The JOIA XML data stream is created (with an unreliable Patient ID) and transferred to the RMC.

- 570 • **Import Measurements into Database:** The Refractive Measurement Consumer (RMC) processes the JOIA XML data stream and imports it into its database. The RMC links the measurement(s) to the correct patient based upon step “Establish Patient Context”.

9.4.8 Refractive Measurements Model with Valid Patient ID

575 Refractive Measurements Model with Valid Patient ID addresses a scenario where organizations have a Practice Management System (PMS), Electronic Health Record System (EHR) and refractive measurement devices.

580 This model specifies the Eye Care administrative process flow relevant to the scenario where the Refractive Measurement Source (RMS) or the Refractive Measurement Source Importer (RMSI) is able to provide a valid Patient ID in the JOIA XML data stream. The Refractive Measurement Consumer (typically an EHR) is required to use the Patient ID provided by the Refractive Measurement Source or a Refractive Measurement Source Importer to establish the context of the patient. The process flow is shown in Figure 9.4.8-1. The functionality of those data flows is specified within the specific transactions.

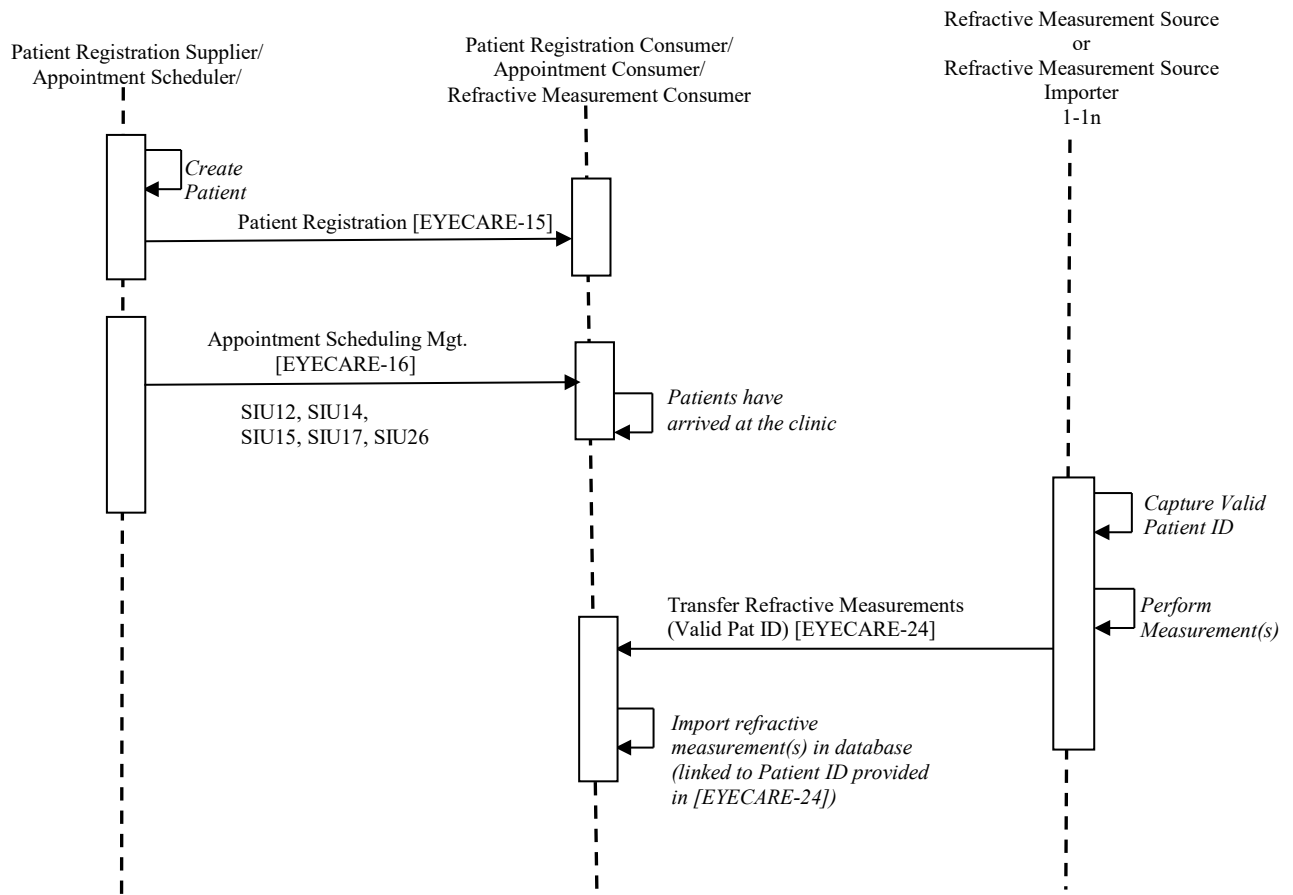

585 **Figure 9.4.8-1: Refractive Measurements Model with Patient ID - Administrative Process Flow**

- **Patient Registration:** New patient demographics and updates are sent to consuming systems.
- 590 • **Appointment Scheduling:** The patient’s appointment is created/managed and sent to consuming systems. This includes new appointments, updates such as confirmed, arrived, checked in, complete. It also supports cancel/delete appointments and patient no shows.
- **Capture Patient ID:** The Refractive Measurement Source (RMS) or Refractive Measurement Source Importer (RMSI) captures the valid Patient ID and links the measurement(s) to the patient. How this is accomplished is outside the scope of IHE.
- 595 • **Perform Measurements:** Each Refractive Measurement Source (RMS) or Refractive Measurement Source Importer (RMSI) creates one or more types of refractive measurements (keratometry, lensometry and refractive, etc.). The JOIA XML data stream is created (with a valid Patient ID) and transferred to the RMC.
- 600 • **Import Measurements into Database:** The Refractive Measurement Consumer (RMC) processes the JOIA XML data stream and imports it into its database. The Refractive Measurement Consumer uses the Patient ID in the data stream to associate the received measurement data with a specific patient.

9.4.9 Device Patient List Option

605 Device Patient List Option addresses a scenario where organizations have a Practice Management System (PMS), Electronic Health Record System (EHR) and refractive measurement devices.

610 The Device Patient List Option defines the Eye Care administrative process flow relevant to the scenario where the acquisition actors (such as a Refractive Measurement Source or Refractive Measurement Source Importer) queries to obtain a list of patients (with associated patient demographics) that have arrived at the organization (e.g., checked into an eye care clinic). This patient list is used to select the patient being examined so that patient identifiers and patient demographics are linked to the output of the acquisition device (such as a JOIA XML data stream for refractive measurements). The process flow is shown in Figure 9.4.9-1. The functionality of those data flows is specified within the specific transactions.

615 Note: This IHE option uses DICOM protocols and is outside the scope of the JOIA specification.

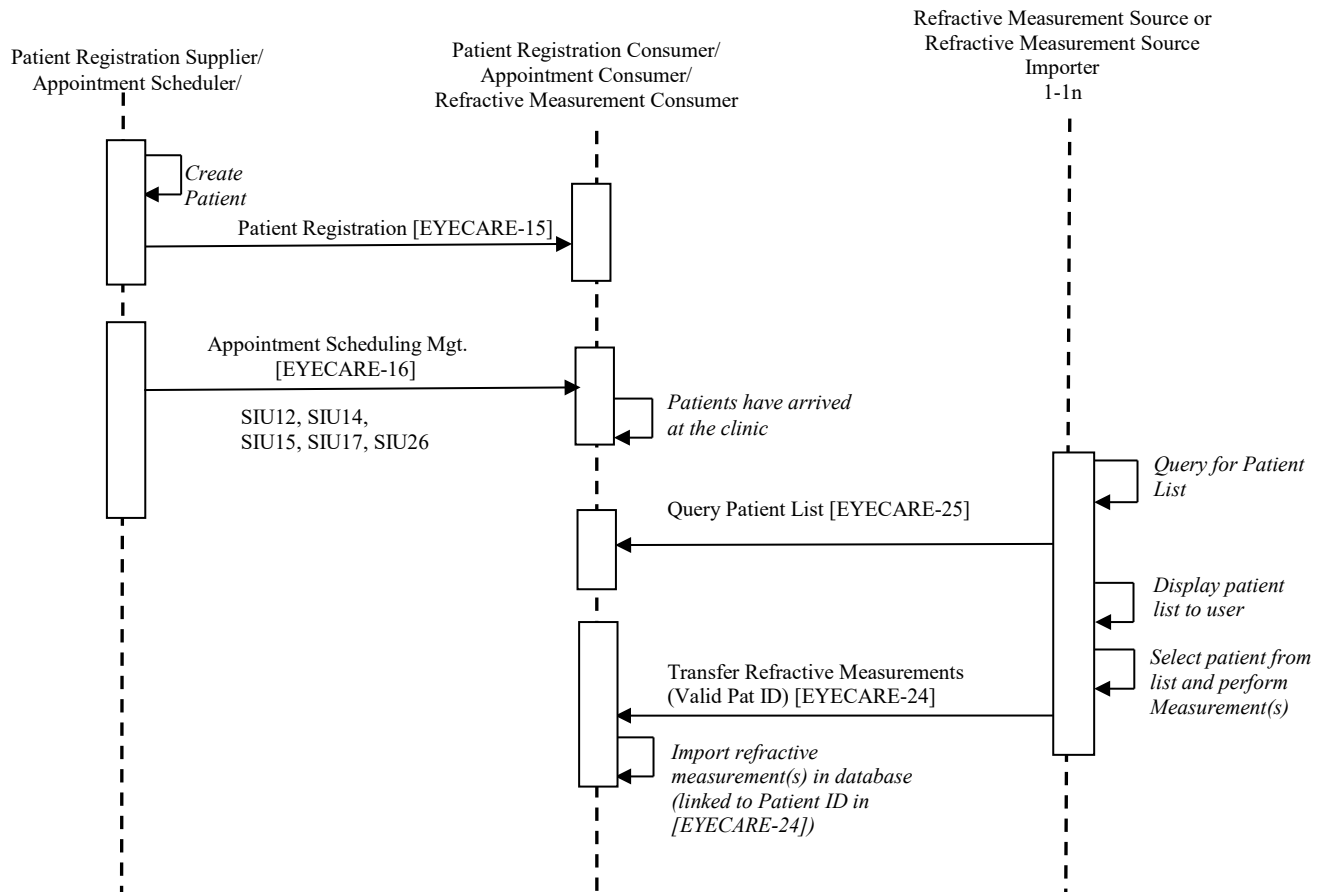

Figure 9.4.9-1: Device Patient List Option - Administrative Process Flow

- 620 • **Patient Registration:** New patient demographics and updates are sent to consuming systems.
- **Appointment Scheduling:** The patient’s appointment is created/managed and sent to consuming systems. This includes new appointments, updates such as confirmed, arrived, checked in, complete. It also supports cancel/delete appointments and patient no shows.
- 625 • **Query for Patient List:** The Refractive Measurement Source or Refractive Measurement Source Importer queries the Refractive Measurement Consumer (RMC) for a list of patients that have arrived at the organization.
- **Display Patient List to User:** The Refractive Measurement Source or Refractive Measurement Source Importer displays the list of patients (i.e., Patient ID and patient demographics) returned by the Refractive Measurement Consumer (RMC) to the user.
- 630 • **Select Patient from List and Perform Measurements:** The user of the Refractive Measurement Source or Refractive Measurement Source Importer selects the patient from

635 the list and creates one or more types of refractive measurements (keratometry, lensometry, refractive, etc.). The JOIA XML data stream is created (with an “auto patient list” PatientIDSource), includes patient demographics from the list, and is transferred to the RMC.

- **Import Measurements into Database:** The Refractive Measurement Consumer (RMC) processes the JOIA XML data stream and imports it into its database. The Refractive Measurement Consumer uses the Patient ID in the data stream to associate the received measurement data with a specific patient.

640

9.5 Unified Eye Care Workflow Use Cases

.....

<i>Add Refractive Use Case example and reorder sections</i>

645 9.8 Refractive Measurements Use Case

Refractive measurements are key components of a patient’s eye care encounter. There is a broad range of instruments and measurements in this domain, and many are commonly required for most routine patient examinations.

- 650
1. A healthy patient with no ocular or visual complaints presents for a routine eye examination. As a matter of routine the prescription for her bifocal spectacles and her monovision reading spectacles are measured using lensometry. The lensometer either gathers demographics from the PMS or the technician enters the patient demographics and this information is associated with the lensometry measurements and sent to the
- 655
2. The patient undergoes automated refraction prior to subjective refraction. The autorefractor either gathers demographics from the PMS or the technician enters the patient demographics and this information is associated with the autorefractor measurements and sent to the EHR.
- 660
3. The technician selects the output from the autorefractor into the phoropter and the eye doctor then performs a non-cycloplegic subjective refraction at distance and enters the measurements in to the EHR. Assessment of near vision with this refraction was performed and the need for a near add was determined. Since the patient is a pilot the specific near viewing distance(s) was considered and the near and intermediate add was
- 665
- determined. The pupillary distance (PD) for each viewing distance was measured. The

lens prescription, including sphere power, cylinder power and axis, near and intermediate add power, and PD is sent to the EHR.

670

4. Subsequent to refraction the patient underwent tonometry in both eyes using a Goldmann applanation tonometer. A single measurement was obtained in each eye and the value and time of measurement was sent to the EHR.
5. The EHR has captured the various refractive measurement (KM, REF, LM) and other measurements (TM) are in the patient's medical record.

9.89 Unified Eye Care Workflow Security Considerations

No security considerations are required.

675

9.910 Unified Eye Care Cross-Profile Considerations

None

Glossary

No new terms added to glossary.

680

Volume 2 – Transactions

Add new Section 4.23

685 **4.23 Transfer Refractive Measurement (No Pat ID) [EYECARE-23]**

This section corresponds to the IHE EYE CARE Transfer Refractive Measurement (No Pat ID) [EYECARE-23] transaction.

4.23.1 Scope

690 In the Transfer Refractive Measurement (No Pat ID) transaction, the Refractive Measurement Source is able to transfer one or more eye care refractive measurements using a JOIA defined XML data stream. Example devices include autorefractors, auto-keratometers, lensometers, etc. The data stream does NOT include a valid Patient ID; therefore, the Refractive Measurement Consumer (typically an EHR) is required to establish the context of the patient before receiving the data stream from the Refractive Measurement Source. It uses the context to provide the
695 correct patient information when importing the measurement(s) into its database.

4.23.2 Use Case Roles

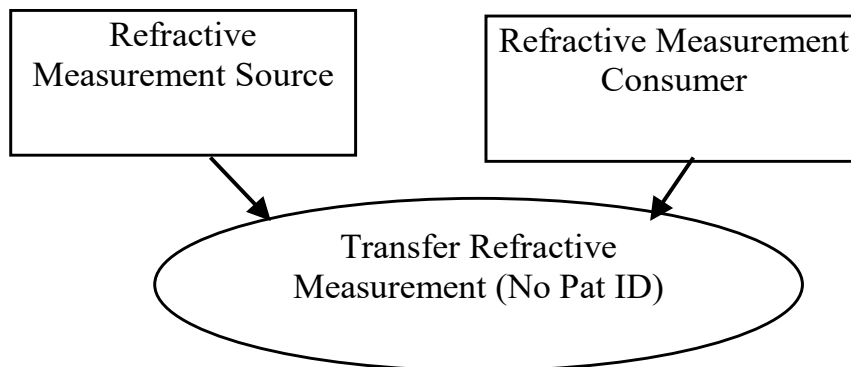

Actor: Refractive Measurement Source

700 **Role:** Transmit eye care refractive measurements

Actor: Refractive Measurement Consumer

Role: Accept and import refractive measurements into database

4.23.3 Referenced Standards

705 Common Specification for output data of Ophthalmic Examination Equipment 01 (JOIA • STD.001-1.5 2016)

4.23.4 Interaction Diagram

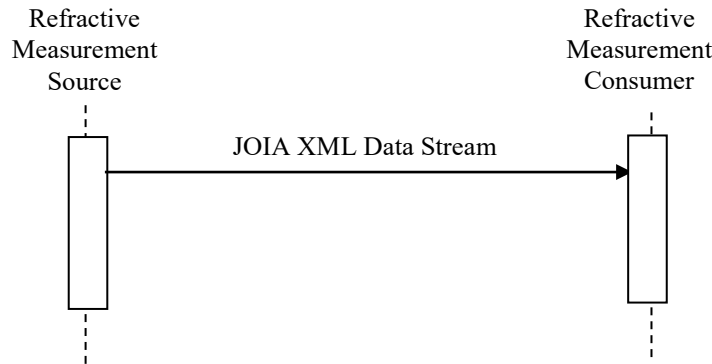

4.23.4.1 Transfer Refractive Measurement (No Pat ID)

4.23.4.1.1 Trigger Events

710 The capture of one or more refractive measurements belonging to a single patient.

- XML data stream based upon defined JOIA data classifications

4.23.4.1.2 Message Semantics

715 The Transfer Refractive Measurement (No Pat ID) is performed by a JOIA XML data stream. The Refractive Measurement Source SHALL generate the data stream after capturing refractive measurements for a patient. The XML data stream does not include a valid Patient ID.

The Refractive Measurement Source SHALL send all of the required (Δ , \circ) data elements for the respective data classification(s) sent (i.e., REF, KM, TM, LM, etc.).

4.23.4.1.2.1 Common data Extensions

720 Common data is used to identify information such as patient demographics and identifier, company, version, etc. IHE Eye Care defines a required extension to convey the Patient ID source.

The Refractive Measurement Source SHALL send data element <PatientIDSource>.

The value of <PatientIDSource> SHALL be set to:

- unreliable – not a valid Patient ID (i.e., a device generated exam number)

725

Note: The data element <ID> under the <Patient> section is required to contain a value, as it is “o”. Since the Refractive Measurement Source does not know the “real Patient ID”, it is recommended to fill in this field with a device generated exam number. However, the value conveyed is outside the scope of IHE. It is the responsibility for the Refractive Measurement Consumer to establish a context to the correct patient for the measurements.

730

Note: The values of “manual”, “auto device” and “auto patient list” are not supported by this transaction.

4.23.4.1.2.2 Refractometer (REF) Clarifications

The following section provides refractometer data classification clarifications to the JOIA specification.

- 735
- For data element <CylinderMode>, the term “mix” has the following definition:
"mix" = the cylindrical power by positive reading when the refractive power is positive for any meridional angle and the cylindrical power by negative reading in other cases.

IHE clarifies the definition for the words “refractive power” to be “spherical power”:

- 740
- "mix" = the cylindrical power by positive reading when the ~~refractive~~ **spherical** power is positive for any meridional angle and the cylindrical power by negative reading in other cases.

4.23.4.1.2.3 Tonometer (TM) Recommendations

The following section provides tonometer data classification clarifications to the JOIA specification.

- 745
- IHE highly recommends <CorrectedIOP> not be filled in or used due to lack of evidence basis or validation of an algorithm.

4.23.4.1.2.4 Lensmeter (REF) Clarifications

The following section provides lensometer data classification clarifications to the JOIA specification.

- 750
- The data element <PD>, <Distance unit="mm">, has the description “Far pupillary distance”. This typically is the distance at optical infinity; however for a scenario when “occupational glasses, etc.” are used “far” may actually be an intermediate PD defined by the specific use case of the glasses.

4.23.4.1.2.5 Expected Action

The Refractive Measurement Consumer SHALL support at least one of the data classifications defined in the JOIA specification.

The Refractive Measurement Consumer SHALL update its local database based upon the information received via the JOIA XML data stream. The extent of import is not defined by IHE.

- 760
- The data element <PatientIDSource> is set to “unreliable”, therefore the Refractive Measurement Consumer SHALL be able to establish the context for the patient prior to receiving this transaction. It SHALL import the refractive measurement(s) to the proper patient in its database based upon establishing the patient context. How this is accomplished is outside the scope of IHE.

765 **4.23.5 Transport Requirements**

The JOIA XML data stream may be transmitted via many transport mechanism (e.g., TCP/IP, RS-232, FTP files etc.). IHE does not define any transport requirements for the JOIA XML data stream.

4.23.6 Security Considerations

770 There are no security considerations for this transition.

4.23.6.1 Security Audit Considerations

There are no specific ATNA security audit events associated with this transaction nor requirements on the encoding of that audit event.

775 *Add new Section 4.24*

4.24 Transfer Refractive Measurement (Valid Pat ID) [EYECARE-24]

This section corresponds to the IHE EYE CARE Transfer Refractive Measurement (Valid Pat ID) [EYECARE-24] transaction.

4.24.1 Scope

780 In the Transfer Refractive Measurement (Valid Pat ID) transaction, the Refractive Measurement Source is able to transfer one or more eye care refractive measurements with a valid Patient ID using a JOIA defined XML data stream. Therefore, the Refractive Measurement Consumer (typically an EHR) is required to use the Patient ID provided by the Refractive Measurement Source to establish the context of the patient. It uses the context to provide the correct patient
785 information when importing the measurement(s) into its database. Some example devices include autorefractors, auto-keratometers, lensometers, etc.

4.24.2 Use Case Roles

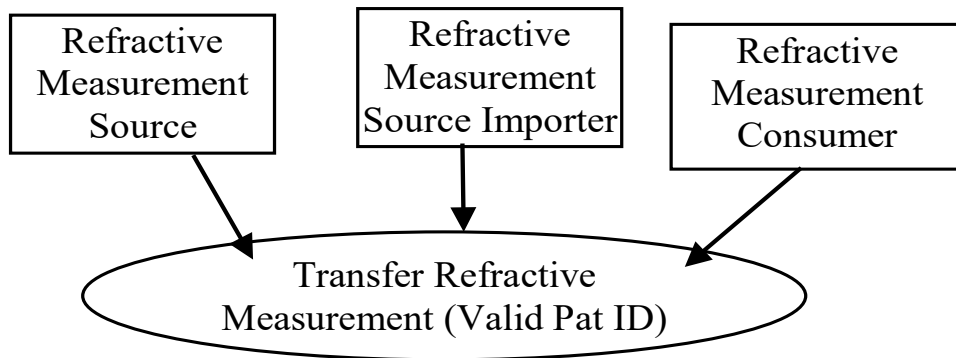

790

Actor: Refractive Measurement Source and Refractive Measurement Source Importer

Role: Transmit eye care refractive measurements

Actor: Refractive Measurement Consumer

Role: Accept and import refractive measurements into database

795 **4.24.3 Referenced Standards**

Common Specification for output data of Ophthalmic Examination Equipment 01 (JOIA • STD.001-1.5 2016)

4.24.4 Interaction Diagram

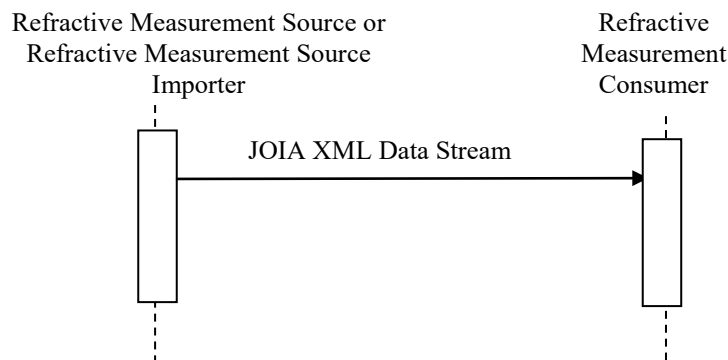

800 **4.24.4.1 Transfer Refractive Measurement (Valid Pat ID)**

4.24.4.1.1 Trigger Events

The capture of one or more refractive measurements belonging to a single patient.

- XML data stream based upon defined JOIA data classifications

4.24.4.1.2 Message Semantics

805 The Transfer Refractive Measurement (Valid Pat ID) is performed by a JOIA XML data stream. The Refractive Measurement Source or Refractive Measurement Source Importer Actors SHALL generate the data stream after capturing refractive measurements for a patient. The XML data stream includes a valid Patient ID.

810 The Refractive Measurement Source and Refractive Measurement Source Importer Actors SHALL send all of the required (Δ , \circ) data elements for the respective data classification(s) sent (i.e., REF, KM, TM, LM, etc.).

4.24.4.1.2.1 Common data Extensions

815 Common data is used to identify information such as patient demographics and identifier, company, version, etc. IHE Eye Care defines a required extension to convey the Patient ID source.

The Refractive Measurement Source and Refractive Measurement Source Importer Actors SHALL send the data element <PatientIDSource>.

The value of <PatientIDSource> SHALL be set to one of the values below:

- 820 • manual – Patient ID manually entered on the device
- auto device – Patient ID automatically entered on the device (i.e., barcode scanner, etc.)
- auto patient list – Patient ID selected from a patient list generated by the Patient Source in the clinic (i.e., Practice Management System)

825 Note: <PatientIDSource> being set to “manual” is supported by IHE however is encouraged as the last possible choice. Studies have shown a possible high error rate when a human types in the Patient ID (some as much as 30% error rate).

Note: The value of “unreliable” is not supported by this transaction.

4.24.4.1.2.2 Refractometer (REG) Clarifications

See Section 4.23.4.1.2.2.

4.24.4.1.2.3 Tonometer (TM) Recommendations

830 See Section 4.23.4.1.2.3.

4.24.4.1.2.4 Lensmeter (LM) Extensions and Clarifications

See Sections 4.23.4.1.2.4.

4.24.4.1.2.5 Expected Action

835 The Refractive Measurement Consumer SHALL support at least one of the data classifications defined in the JOIA specification.

The Refractive Measurement Consumer SHALL update its local database based upon the information received via the JOIA XML data stream. The extent of import is not defined by IHE.

840 The data element <PatientIDSource> is set to “manual”, “auto device” or “auto patient list”, therefore the Refractive Measurement Consumer SHALL be able to establish the context for the patient based upon the Patient ID in the XML data stream. It SHALL import the refractive measurement(s) to the proper patient in its database based upon the Patient ID.

4.24.5 Transport Requirements

845 The JOIA XML data stream may be transmitted via many transport mechanism (e.g., TCP/IP, RS-232, FTP files etc.). IHE does not define any transport requirements for the JOIA XML data stream.

4.24.6 Security Considerations

There are no security considerations for this transition.

4.24.6.1 Security Audit Considerations

850 There are no specific ATNA security audit events associated with this transaction nor requirements on the encoding of that audit event.

<i>Add new Section 4.25</i>

4.25 Query Patient List [EYECARE-25]

This section corresponds to the IHE EYE CARE Query Patient List [EYECARE-25] transaction.

4.25.1 Scope

855 The Query Patient List transaction provides the ability to obtain a list of patients (with associated patient demographics) that have arrived at the organization (e.g., checked into an eye care clinic).

860 This transaction uses DICOM Modality Worklist (DICOM MWL). DICOM MWL is based upon patient and orders, however, only the patient attributes of DICOM MWL are of interest. It is intended for acquisition devices (such as eye care refractive instruments) that are used for patient examinations, but are not based upon orders.

In the Transfer Refractive Measurements (EYECARE-23 and EYECARE-24) transactions, this information will be included in the Common Data element section of the JOIA XML data stream.

865 The IHE transactions using the JOIA XML data stream do not define the transport protocol to connect systems. However, DICOM requires the use of a TCP/IP connection to exchange DICOM messages and this transaction uses the transport as defined by the DICOM standard.

4.25.2 Use Case Roles

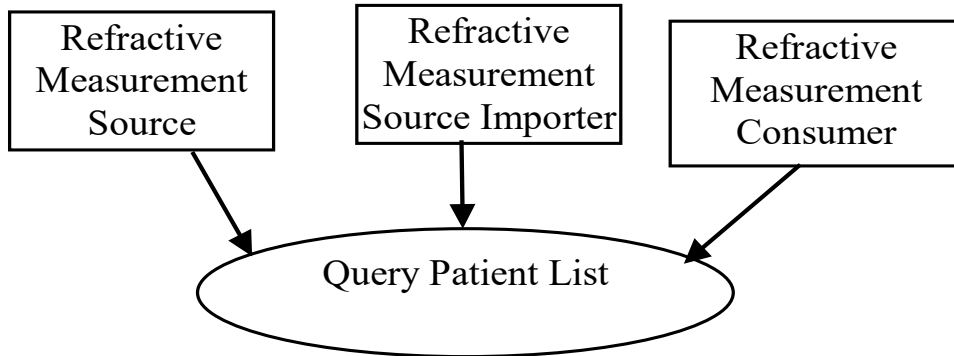

870

Actor: Refractive Measurement Source or Refractive Measurement Source Importer

Role: Queries for Patient List

Actor: Refractive Measurement Consumer

Role: Accepts requests for Patient List, performs query, sends response

875

4.25.3 Referenced Standards

DICOM PS 3.4: Modality Worklist SOP Class

4.25.4 Interaction Diagram

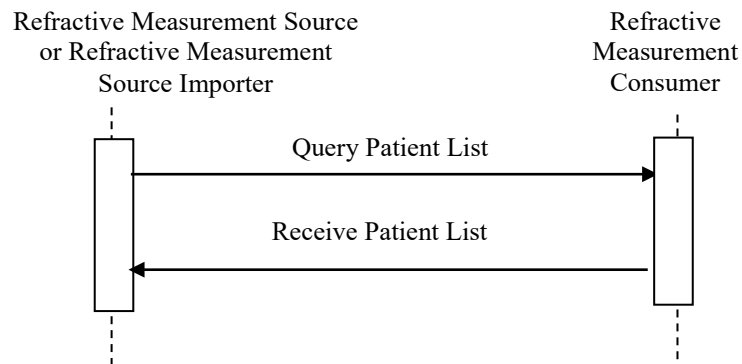

4.25.4.1 Query Patient List Message

880

4.25.4.1.1 Trigger Events

Patients arrived at the organization. The patient arrives at the Refractive Measurement Source or Refractive Measurement Source Importer for examination.

The trigger event for the patient list is site specific, but may be triggered by such events as:

- A user initiates a query to obtain the list of patients that are checked in the organization
- 885 • The Refractive Measurement Source or Refractive Measurement Source Importer automatically queries for patients that have arrived at the organization.

4.25.4.1.2 Message Semantics

890 The Refractive Measurement Source or Refractive Measurement Source Importer uses the C-FIND Request of the DICOM Modality Worklist SOP Class to query for a patient list from the Refractive Measurement Consumer. The Refractive Measurement Source or Refractive Measurement Source Importer performs the SCU role, and the Refractive Measurement Consumer the SCP role.

895 DICOM MWL is based upon patient and orders. This transaction is only interested in the patient information of MWL so although there are required DICOM attributes related to orders (procedures) in the standard, how they are used and filled in are not relevant.

The Refractive Measurement Source or Refractive Measurement Source Importer Actors SHALL support the ability to query for patients currently available for examinations. This is accomplished by matching for “today’s date” and relevant modality shown in Table 4.25.4.1.2-1.

Table 4.25.4.1.2-1: MWL Key for Matching

Matching Key Attributes	Tag	Value
Scheduled Procedure Step Start Date	(0040,0002)	DICOM format for the current date: “YYYYMMDD”
Modality	(0008,0060)	Defined Terms: AR (Autorefraction) KER (Keratometry) LEN (Lensometry) SRF (Subjective Refraction)

900

4.25.4.1.2.1 Matching Keys and Return Keys for Display

905 Table 4.25.4.1.2.1-1 summarizes the matching key requirements and lists the optional and required attributes that may be requested and are expected to be returned in order to make these available to the user at the Refractive Measurement Source or Refractive Measurement Source Importer.

- R Required (as defined by DICOM)
- O Optional (as defined by DICOM)

The following modifiers are also used:

- R+ The requirement is an IHE extension of the DICOM requirements.
- 910 • **R+** ***Bolded and in italic*** SHALL be displayed to the user in the SCU

915 The focus is upon patient demographic information that may be used for refractive measurements based upon the output of the acquisition actor (i.e., JOIA XML specification). Since DICOM MWL addresses both patient and order information, many of the required DICOM attributes are not relevant. However, implementations have to be DICOM conformant; therefore, SCP systems need to have the ability to fill in required DICOM return keys. How this information is conveyed is outside the scope of IHE.

All display requirements are an addition to the DICOM Standard requirements for the Modality Worklist SOP Class.

Table 4.25.4.1.2.1-1: Return and Matching Keys for Modality Worklist

Attribute Name	Tag	Query Keys Matching		Query Keys Return	
		SCU	SCP	SCU	SCP
Scheduled Procedure Step					
Scheduled Procedure Step Sequence	(0040,0100)			[IHE-1]	[IHE-2]
>Scheduled Station AE Title	(0040,0001)	O	O	O	R
>Scheduled Procedure Step Start Date	(0040,0002)	R+	R	R+	R
>Scheduled Procedure Step Start Time	(0040,0003)	O	R	O	R
> Scheduled Procedure Step Location	(0040,0011)	O	O	O	O
>Modality	(0008,0060)	R+	R	R+	R
>Scheduled Performing Physician's Name	(0040,0006)	O	R	O	R
>Scheduled Procedure Step ID	(0040,0009)	O	O	O	R
>Scheduled Protocol Code Sequence	(0040,0008)				
>>Code Value	(0008,0100)	O	O		R
>>Coding Scheme Version	(0008,0103)	O	O	O	O
>>Coding Scheme Designator	(0008,0102)	O	O	O	R
>>Code Meaning	(0008,0104)	O	O	O	O
>Scheduled Procedure Step Description	(0040,0007)	O	O	O	R
Requested Procedure					
Requested Procedure Comments	(0040,1400)	O	O	O	O
Requested Procedure Description	(0032,1060)	O	O	O	O
Requested Procedure Code Sequence	(0032,1064)				
>Code Value	(0008,0100)	O	O	O	R
>Coding Scheme Version	(0008,0103)	O	O	O	O

IHE Eye Care Technical Framework Supplement – Unified Eye Care Workflow Refractive Measurements

Attribute Name	Tag	Query Keys Matching		Query Keys Return	
		SCU	SCP	SCU	SCP
>Coding Scheme Designator	(0008,0102)	O	O	O	R
>Code Meaning	(0008,0104)	O	O	O	R
Requested Procedure ID	(0040,1001)	O	R	O	R
Names of Intended recipients of results	(0040,1010)	O	O	O	O
Study Instance UID	(0020,000D)	O	O	O	R
Referenced Study Sequence	(0008,1110)				
>Referenced SOP Class UID	(0008,1150)	O	O	O	R
>Referenced SOP Instance UID	(0008,1155)	O	O	O	R
Imaging Service Request					
Imaging Service Request Comments	(0040,2400)	O	O	O	O
Accession Number	(0008,0050)	O	R	O	R
Requesting Physician	(0032,1032)	O	O	O	R
Requesting Service	(0032,1033)	O	O	O	O
Referring Physician's Name	(0008,0090)	O	O	O	R
Visit Identification					
Admission ID	(0038,00100)	O	O	O	R
Visit Status					
Current Patient Location	(0038,0300)	O	O	O	R
Visit Relationship					
Referenced Patient Sequence	(0008,1120)				
>Referenced SOP Class UID	(0008,1150)	O	O	O	R
>Referenced SOP Instance UID	(0008,1155)	O	O	O	R
Patient Identification					
Patient's Name	(0010,0010)	O	R	R+	R
Patient ID	(0010,0020)	O	R	R+	R
Other Patient ID's	(0010,1000)	O	O	O	O
Patient Demographic					
Patients Birth Date	(0010,0030)	O	O	R+	R
Patient's Sex	(0010,0040)	O	O	R+	R
Confidentiality constraint on patient data	(0040,3001)	O	O	O	R
Ethnic Group	(0010,2160)	O	O	O	O
Patient Comment	(0010,4000)	O	O	O	O
Patient Medical					
Patient State	(0038,0500)	O	O	O	R
Pregnancy Status	(0010,21C0)	O	O	O	R

Attribute Name	Tag	Query Keys Matching		Query Keys Return	
		SCU	SCP	SCU	SCP
Medical Alerts	(0010,2000)	O	O	O	R
Additional Patient History	(0010,21B0)	O	O	O	O
Contrast Allergies	(0010,2110)	O	O	O	R
Patient Weight	(0010,1030)	O	O	O	R
Special Needs	(0038,0050)	O	O	O	R

920

Notes:

[IHE 1] SCU implementations may choose to obtain the values contained in attributes that are part of the Scheduled Procedure Step sequence in either one of three ways. The first one is to request a universal match on the sequence attribute (zero length attribute). The second one is a universal sequence match (zero length item) for all attributes of the Scheduled Procedure Step sequence. The third one is to request a universal attribute match for selected attributes contained in the Scheduled Procedure Step sequence.

925

[IHE-2]: SCP implementations shall support, per the DICOM Standard, three ways to let the Query SCU obtain the values contained in attributes that are part of the Scheduled Procedure Step sequence. The first one is to support a universal match on the sequence attribute (zero length attribute), and all managed attributes will be returned. The second one is to support a universal sequence match (zero length item) for all attributes of the Scheduled Procedure Step sequence, and all managed attributes will be returned. The third one is to support a universal attribute match for selected attributes contained in the Scheduled Procedure Step sequence, and the managed attributes that were selected will be returned.

930

4.25.4.1.3 Expected Action

935 The Refractive Measurement Consumer performs the query and sends the DICOM Modality Worklist to the Refractive Measurement Source or Refractive Measurement Source Importer.

940 The Refractive Measurement Consumer SHALL provide a match for each patient that has arrived at the organization for the date specified in the query request. This is based upon the Appointment Consumer (joined with the Refractive Measurement Consumer) being notified by the Appointment Scheduler that a patient has arrived. This is accomplished via the HL7 SIU message (either a SIU^12 or SIU^14) with the Filler Status Code set to “Arrived” or “Checked In” or “Started”. This triggers the Refractive Measurement Consumer that the patient is available for the exam and available for the patient list.

945 An Appointment Scheduler (typically a PMS) is able to convey many states while the patient is at the organization. “Arrived”, “Checked In” and “Started” may all be conveyed but also only one or two may be sent via the HL7 SIU message. Therefore, the Refractive Measurement Consumer SHALL manage all three statuses to determine a patient is within an organization. It SHALL generate a patient list only once for each patient (i.e., if statuses “Arrived” or “Checked In” or “Started” are received only one match is returned for that specific patient).

950 The Refractive Measurement Source or Refractive Measurement Source Importer SHALL display the attributes as defined in Table 4.25.4.1.2.1-1.

The Refractive Measurement Source or Refractive Measurement Source Importer SHALL include the following attributes in all JOIA XML data streams for matched patients:

- Common data <Patient> section
 - <ID> - Patient ID (0010,0020)
 - <FirstName> - Patient's Name (0010,0010)
 - <MiddleName> - Patient's Name (0010,0010) (if available)
 - <LastName> - Patient's Name (0010,0010)
 - <Sex> - Patient's Sex (0010,0040) (if available)
 - <DOB> - Patient's Birth Date (0010,0030) (if available)

955

960 **4.25.5 Security Considerations**

There are no additional security considerations for the ProQuery Patient List transaction beyond those described in EYECARE TF-1: Appendix E.

4.25.5.1 Security Audit Considerations

There are no specific ATNA security audit events associated with this transaction nor requirements on the encoding of that audit event.

965