

**Integrating the Healthcare Enterprise**



5

**IHE Radiology (RAD)  
Technical Framework**

10

**Volume 2  
IHE RAD TF-2  
Transactions**

15

20

**Revision 22.0 Final Text  
June 25, 2024**

25

**Please verify you have the most recent version of this document, which is published [here](#).**

## CONTENTS

30	1	Introduction .....	33
	1.1	Introduction to IHE .....	33
	1.2	Intended Audience .....	33
	1.3	Overview of Technical Framework Volume 2 .....	33
	1.4	Comment Process.....	34
35	1.5	Copyright Licenses .....	34
	1.6	Trademark .....	34
	1.7	Disclaimer Regarding Patent Rights.....	34
	1.8	History of Document Changes.....	35
	2	Conventions .....	36
40	2.1	The Generic IHE Transaction Model.....	36
	2.2	DICOM Usage Conventions.....	37
	2.3	HL7 Profiling Conventions.....	39
	2.3.1	Static definition – Segment level and Data Type level.....	39
	2.3.2	Static definition - Message level.....	42
45	2.4	HL7 Implementation Notes.....	42
	2.4.1	Common HL7 Message Implementation Requirements.....	42
	2.4.1.1	Network Guidelines.....	42
	2.4.1.2	Acknowledgement Mode.....	43
	2.4.1.3	HL7 Versioning.....	43
50	2.4.1.4	Empty Field .....	43
	2.4.1.5	Z-Segment .....	43
	2.4.2	HL7 v2.3.1 Message Implementation Requirements .....	43
	2.4.2.1	Acknowledgement Message.....	43
	2.4.2.2	Message Control.....	44
55	2.4.2.3	Acknowledgement Modes .....	45
	2.4.2.4	ERR – Error Segment.....	45
	2.4.3	HL7 v2.4 Message Implementation Requirements .....	45
	2.4.4	HL7 v2.5 Message Implementation Requirements .....	45
	2.4.4.1	Acknowledgement Message.....	45
60	2.4.4.2	Message Control.....	46
	2.4.4.3	Acknowledgement Modes.....	48
	2.4.4.4	ERR - Error segment .....	49
	2.5	HL7 and DICOM Mapping Considerations.....	50
	2.6	Use of Coded Entities and Coding Schemes.....	51
65	3	Framework Overview.....	52
	4	IHE Transactions.....	53
	4.1	Patient Registration [RAD-1] .....	53
	4.1.1	Scope.....	53
	4.1.2	Actor Roles .....	53
70	4.1.3	Referenced Standards .....	53

	4.1.4 Messages.....	53
	4.1.4.1 Patient Management – Admit/Register Patient .....	54
	4.1.4.1.1 Trigger Events.....	54
75	4.1.4.1.2 Message Semantics .....	54
	4.1.4.1.2.1 Message Semantics (HL7 v2.3.1).....	54
	4.1.4.1.2.1.1 MSH Segment (HL7 v2.3.1) .....	55
	4.1.4.1.2.1.2 EVN Segment (HL7 v2.3.1).....	55
	4.1.4.1.2.1.3 PID Segment (HL7 v2.3.1).....	55
80	4.1.4.1.2.1.4 PV1 Segment (HL7 v2.3.1).....	56
	4.1.4.1.2.1.5 AL1 Segment (HL7 v2.3.1).....	58
	4.1.4.1.2.1.6 OBX Segment (HL7 v2.3.1).....	58
	4.1.4.1.2.2 Message Semantics (HL7 v2.5.1).....	59
	4.1.4.1.2.2.1 MSH Segment (HL7 v2.5.1) .....	60
85	4.1.4.1.2.2.2 EVN Segment (HL7 v2.5.1).....	60
	4.1.4.1.2.2.3 PID Segment (HL7 v2.5.1).....	60
	4.1.4.1.2.2.4 PV1 Segment (HL7 v2.5.1).....	61
	4.1.4.1.2.2.5 ROL Segment (HL7 v2.5.1).....	62
	4.1.4.1.2.2.6 OBX Segment (HL7 v2.5.1).....	62
90	4.1.4.1.2.2.7 AL1 Segment (HL7 v2.5.1).....	62
	4.1.4.1.3 Expected Actions .....	63
	4.1.4.2 Patient Management – Cancel Admit/Register Patient .....	63
	4.1.4.2.1 Trigger Events.....	63
	4.1.4.2.2 Message Semantics .....	63
95	4.1.4.2.2.1 Message Semantics (HL7 v2.3.1).....	63
	4.1.4.2.2.1.1 MSH Segment (HL7 v2.3.1) .....	64
	4.1.4.2.2.1.2 EVN Segment (HL7 v2.3.1).....	64
	4.1.4.2.2.1.3 PID Segment (HL7 v2.3.1).....	64
	4.1.4.2.2.1.4 PV1 Segment (HL7 v2.3.1).....	64
100	4.1.4.2.2.2 Message Semantics (HL7 v2.5.1).....	65
	4.1.4.2.2.2.1 MSH Segment (HL7 v2.5.1) .....	65
	4.1.4.2.2.2.2 EVN Segment (HL7 v2.5.1).....	65
	4.1.4.2.2.2.3 PID Segment (HL7 v2.5.1).....	66
	4.1.4.2.2.2.4 PV1 Segment (HL7 v2.5.1) .....	66
105	4.1.4.2.3 Expected Actions .....	66
	4.2 Placer Order Management [RAD-2].....	67
	4.2.1 Scope.....	67
	4.2.2 Actor Roles .....	67
	4.2.3 Referenced Standards .....	67
	4.2.4 Messages.....	67
110	4.2.4.1 Order Management – New Order from Order Placer .....	68
	4.2.4.1.1 Trigger Events.....	68
	4.2.4.1.2 Message Semantics .....	69
	4.2.4.1.2.1 Message Semantics (HL7 v2.3.1).....	69
	4.2.4.1.2.1.1 MSH Segment (HL7 v2.3.1) .....	69

---

115	4.2.4.1.2.1.2 PID Segment (HL7 v2.3.1).....	69
	4.2.4.1.2.1.3 PV1 Segment (HL7 v2.3.1).....	70
	4.2.4.1.2.1.4 ORC Segment (HL7 v2.3.1).....	70
	4.2.4.1.2.1.5 OBR Segment (HL7 v2.3.1).....	71
	4.2.4.1.2.2 Message Semantics (HL7 v2.5.1).....	73
120	4.2.4.1.2.2.1 MSH Segment (HL7 v2.5.1).....	74
	4.2.4.1.2.2.2 PID Segment (HL7 v2.5.1).....	74
	4.2.4.1.2.2.3 PV1 Segment (HL7 v2.5.1).....	74
	4.2.4.1.2.2.4 ORC Segment (HL7 v2.5.1).....	75
	4.2.4.1.2.2.5 TQ1 Segment (HL7 v2.5.1).....	77
125	4.2.4.1.2.2.6 OBR Segment (HL7 v2.5.1).....	77
	4.2.4.1.3 Expected Actions .....	79
	4.2.4.2 Order Management - Order Cancelled by Order Placer .....	80
	4.2.4.2.1 Trigger Events.....	80
	4.2.4.2.2 Message Semantics .....	80
130	4.2.4.2.2.1 Message Semantics (HL7 v.2.3.1).....	80
	4.2.4.2.2.1.1 MSH Segment (HL7 v2.3.1) .....	80
	4.2.4.2.2.1.2 PID Segment (HL7 v2.3.1).....	81
	4.2.4.2.2.1.3 PV1 Segment (HL7 v2.3.1).....	81
	4.2.4.2.2.1.4 ORC Segment (HL7 v2.3.1).....	81
135	4.2.4.2.2.2 Message Semantics (HL7 v2.5.1).....	82
	4.2.4.2.2.2.1 MSH Segment (HL7 v2.5.1) .....	82
	4.2.4.2.2.2.2 PID Segment (HL7 v2.5.1).....	83
	4.2.4.2.2.2.3 PV1 Segment (HL7 v2.5.1).....	83
	4.2.4.2.2.2.4 ORC Segment (HL7 v2.5.1).....	83
140	4.2.4.2.3 Expected Actions .....	84
	4.3 Filler Order Management [RAD-3] .....	85
	4.3.1 Scope.....	85
	4.3.2 Actor Roles .....	85
	4.3.3 Referenced Standards .....	85
145	4.3.4 Messages.....	85
	4.3.4.1 Filler Order Management – New Order from Order Filler or Change Order from Order Filler .....	87
	4.3.4.1.1 Trigger Events.....	87
	4.3.4.1.2 Message Semantics .....	87
150	4.3.4.1.2.1 Message Semantics (HL7 v2.3.1).....	87
	4.3.4.1.2.1.1 MSH Segment (HL7 v2.3.1) .....	88
	4.3.4.1.2.1.2 MSA Segment (HL7 v2.3.1) .....	89
	4.3.4.1.2.1.3 PID Segment (HL7 v2.3.1).....	89
	4.3.4.1.2.1.4 PV1 Segment (HL7 v2.3.1).....	89
155	4.3.4.1.2.1.5 ORC Segment (HL7 v2.3.1).....	90
	4.3.4.1.2.1.6 OBR Segment (HL7 v2.3.1).....	90
	4.3.4.1.2.1.7 ERR Segment (HL7 v2.3.1) .....	91
	4.3.4.1.2.2 Message Semantics (HL7 v2.5.1).....	91

	4.3.4.1.2.2.1 MSH Segment (HL7 v2.5.1) .....	92
160	4.3.4.1.2.2.2 MSA Segment (HL7 v2.5.1) .....	93
	4.3.4.1.2.2.3 PID Segment (HL7 v2.5.1).....	93
	4.3.4.1.2.2.4 PV1 Segment (HL7 v2.5.1).....	93
	4.3.4.1.2.2.5 ORC Segment (HL7 v2.5.1).....	94
	4.3.4.1.2.2.6 TQ1 Segment (HL7 v2.5.1).....	95
165	4.3.4.1.2.2.7 OBR Segment (HL7 v2.5.1).....	95
	4.3.4.1.2.2.8 ERR Segment (HL7 v2.5.1 Option) .....	96
	4.3.4.1.3 Expected Actions .....	97
	4.3.4.2 Filler Order Management - Order Status Update .....	97
	4.3.4.2.1 Trigger Events.....	97
170	4.3.4.2.2 Message Semantics .....	97
	4.3.4.2.2.1 Message Semantics (HL7 v2.3.1).....	97
	4.3.4.2.2.1.1 MSH Segment (HL7 v2.3.1) .....	97
	4.3.4.2.2.1.2 ORC Segment (HL7 v2.3.1).....	98
	4.3.4.2.2.2 Message Semantics (HL7 v2.5.1).....	98
175	4.3.4.2.2.2.1 MSH Segment (HL7 v2.5.1) .....	99
	4.3.4.2.2.2.2 ORC Segment (HL7 v2.5.1).....	99
	4.3.4.2.2.2.3 TQ1 Segment (HL7 v2.5.1).....	100
	4.3.4.2.2.2.4 OBR Segment (HL7 v2.5.1).....	100
	4.3.4.2.3 Expected Actions .....	101
180	4.3.4.3 Filler Order Management - Order Cancelled by the Order Filler.....	101
	4.3.4.3.1 Trigger Events.....	101
	4.3.4.3.2 Message Semantics .....	102
	4.3.4.3.2.1 Message Semantics (HL7 v2.3.1).....	102
	4.3.4.3.2.1.1 MSH Segment (HL7 v2.3.1) .....	102
185	4.3.4.3.2.1.2 PID Segment (HL7 v2.3.1).....	102
	4.3.4.3.2.1.3 PV1 Segment (HL7 v2.3.1).....	102
	4.3.4.3.2.1.4 ORC Segment (HL7 v2.3.1).....	103
	4.3.4.3.2.2 Message Semantics (HL7 v2.5.1).....	103
	4.3.4.3.2.2.1 MSH Segment (HL7 v2.5.1) .....	104
190	4.3.4.3.2.2.2 PID Segment (HL7 v2.5.1).....	104
	4.3.4.3.2.2.3 PV1 Segment (HL7 v2.5.1).....	104
	4.3.4.3.2.2.4 ORC Segment (HL7 v2.5.1).....	105
	4.3.4.3.2.2.5 OBR Segment (HL7 v2.5.1).....	105
	4.3.4.3.3 Expected Actions .....	106
195	4.4 Procedure Scheduled [RAD-4] .....	107
	4.4.1 Scope.....	107
	4.4.2 Actor Roles .....	107
	4.4.3 Referenced Standards .....	108
	4.4.4 Messages.....	108
200	4.4.4.1 Procedure Scheduled Message .....	110
	4.4.4.1.1 Trigger Events.....	110
	4.4.4.1.2 Message Semantics .....	110

---

	4.4.4.1.2.1	Message Semantics (HL7 v2.3.1).....	110
	4.4.4.1.2.1.1	MSH Segment (HL7 v2.3.1) .....	111
205	4.4.4.1.2.1.2	PID Segment (HL7 v2.3.1).....	111
	4.4.4.1.2.1.3	PV1 Segment (HL7 v2.3.1).....	111
	4.4.4.1.2.1.4	ORC Segment (HL7 v2.3.1).....	112
	4.4.4.1.2.1.5	OBR Segment (HL7 v2.3.1).....	113
	4.4.4.1.2.2	Message Semantics (HL7 v2.5.1).....	116
210	4.4.4.1.2.2.1	MSH Segment (HL7 v2.5.1) .....	117
	4.4.4.1.2.2.2	PID Segment (HL7 v2.5.1).....	117
	4.4.4.1.2.2.3	PV1 Segment (HL7 v2.5.1).....	117
	4.4.4.1.2.2.4	Intentionally Left Blank .....	118
	4.4.4.1.2.2.5	ORC Segment (HL7 v2.5.1).....	118
215	4.4.4.1.2.2.6	TQ1 Segment (HL7 v2.5.1).....	119
	4.4.4.1.2.2.7	OBR Segment (HL7 v2.5.1).....	120
	4.4.4.1.2.2.8	IPC Segment (HL7 v2.5.1).....	122
	4.4.4.1.2.2.9	Enterprise Identity Option .....	122
	4.4.4.2	Expected Actions.....	123
220	4.4.4.2.1	Use Cases .....	123
	4.5	Query Modality Worklist [RAD-5] .....	126
	4.5.1	Scope.....	126
	4.5.2	Actor Roles .....	126
	4.5.3	Referenced Standards .....	127
225	4.5.4	Messages.....	127
	4.5.4.1	Query Scheduled MWL Message.....	127
	4.5.4.1.1	Trigger Events.....	128
	4.5.4.1.2	Message Semantics .....	128
	4.5.4.1.2.1	Examples for the Use of Matching Key Attributes .....	129
230	4.5.4.1.2.2	Matching Keys and Return Keys .....	129
	4.5.4.1.2.3	Enterprise Identity Option .....	134
	4.5.4.1.3	Expected Actions .....	135
	4.5.4.1.3.1	Intentionally Left Blank .....	135
	4.5.4.2	Receive Scheduled MWL Message.....	135
235	4.5.4.2.1	Trigger Events.....	135
	4.5.4.2.2	Message Semantics .....	136
	4.5.4.2.2.1	Scheduled Protocol Sequence for Import .....	136
	4.5.4.2.2.2	Intentionally Left Blank.....	137
	4.5.4.2.3	Expected Actions .....	137
240	4.5.4.2.3.1	Intentionally Left Blank .....	137
	4.6	Modality Procedure Step In Progress [RAD-6].....	138
	4.6.1	Scope.....	138
	4.6.2	Actor Roles .....	138
	4.6.3	Referenced Standards .....	139
245	4.6.4	Messages.....	139
	4.6.4.1	Procedure Step In Progress Message.....	139

	4.6.4.1.1	Trigger Event .....	139
	4.6.4.1.2	Message Semantics .....	140
250	4.6.4.1.2.1	Patient/Procedure/Scheduled Procedure Step Information.....	140
	4.6.4.1.2.2	Required Attributes.....	140
	4.6.4.1.2.3	Relationship between Scheduled and Performed Procedure Steps..	140
	4.6.4.1.2.3.1	Simple Case .....	140
	4.6.4.1.2.3.2	Unscheduled Case .....	141
255	4.6.4.1.2.3.3	Append Case.....	141
	4.6.4.1.2.3.4	Group Case .....	142
	4.6.4.1.2.3.5	Abandoned Case .....	143
	4.6.4.1.2.3.6	Group Case with Presentation of Grouped Procedures .....	144
	4.6.4.1.2.4	Protocol Handling.....	145
	4.6.4.1.2.4.1	Manual Modality Setting.....	146
260	4.6.4.1.2.4.2	Assisted Acquisition Protocol Setting Option.....	146
	4.6.4.1.2.5	Enterprise Identity Option.....	148
	4.6.4.1.3	Expected Actions .....	149
	4.6.4.1.3.1	Intentionally Left Blank.....	150
	4.7	Modality Procedure Step Completed/Discontinued [RAD-7] .....	151
265	4.7.1	Scope.....	151
	4.7.2	Actor Roles .....	151
	4.7.3	Referenced Standards .....	151
	4.7.4	Messages.....	152
	4.7.4.1	Procedure Step Completed/Discontinued.....	152
270	4.7.4.1.1	Trigger Event .....	152
	4.7.4.1.2	Message Semantics .....	152
	4.7.4.1.2.1	Retrieve AE Title.....	153
	4.7.4.1.2.2	PPS Exception Management Option .....	153
	4.7.4.1.2.3	Billing and Material Management Information.....	154
275	4.7.4.1.2.4	Protocol Handling.....	155
	4.7.4.1.3	Expected Actions .....	155
	4.7.4.1.3.1	PPS Exception Management Option .....	156
	4.7.4.1.3.2	Billing and Material Management Information.....	156
	4.7.4.1.3.3	Intentionally Left Blank.....	156
280	4.8	Modality Images Stored [RAD-8] .....	157
	4.8.1	Scope.....	157
	4.8.2	Actor Roles .....	157
	4.8.3	Referenced Standards .....	157
	4.8.4	Messages.....	157
285	4.8.4.1	Images Stored .....	157
	4.8.4.1.1	Trigger Events.....	157
	4.8.4.1.1.1	Study UIDs and Series UIDs .....	158
	4.8.4.1.2	Message Semantics .....	158
	4.8.4.1.2.1	Storage of Localizer Images (MR and CT) .....	159
290	4.8.4.1.2.2	Storage of NM Images (NMI) .....	159

	4.8.4.1.2.3	Storage of Full Field Digital Mammography Images.....	162
	4.8.4.1.2.3.1	Partial View Option.....	164
	4.8.4.1.2.3.2	Background Air Suppression .....	165
295	4.8.4.1.2.3.3	Cleavage Views.....	165
	4.8.4.1.2.3.4	Digitized Film .....	165
	4.8.4.1.2.4	Recording of X-Ray Dose Information .....	166
	4.8.4.1.2.5	Storage of Enhanced DICOM Objects .....	166
	4.8.4.1.2.6	Intentionally Left Blank.....	166
300	4.8.4.1.2.7	Storage of Digital Breast Tomosynthesis Images .....	166
	4.8.4.1.2.7.1	Partial View Option.....	171
	4.8.4.1.2.7.2	Breast Projection X-Ray Images Options .....	171
	4.8.4.1.2.8	Enterprise Identity Option.....	174
	4.8.4.1.2.9	Intentionally Left Blank .....	175
305	4.8.4.1.2.10	Recording of Radiopharmaceutical Administered Activity Information .....	175
	4.8.4.1.3	Expected Actions .....	177
	4.8.4.1.3.1	DICOM Image Storage SOP Classes .....	177
	4.8.4.1.3.2	Enterprise Identity Option.....	179
310	4.9	Modality Presentation State Stored [RAD-9] .....	181
	4.9.1	Scope.....	181
	4.9.2	Actor Roles .....	181
	4.9.3	Referenced Standards .....	181
	4.9.4	Messages.....	181
315	4.9.4.1	Modality Presentation State Stored .....	182
	4.9.4.1.1	Trigger Events.....	182
	4.9.4.1.2	Message Semantics .....	182
	4.9.4.1.3	Expected Actions .....	182
320	4.10	Storage Commitment [RAD-10].....	182
	4.10.1	Scope .....	182
	4.10.2	Actor Roles.....	182
	4.10.3	Referenced Standards .....	183
	4.10.4	Messages.....	184
325	4.10.4.1	Request Commitment Message.....	184
	4.10.4.1.1	Trigger Events.....	184
	4.10.4.1.2	Message Semantics .....	184
	4.10.4.1.3	Expected Actions .....	184
	4.10.4.2	Report Commitment Result Message .....	184
	4.10.4.2.1	Trigger Events .....	185
	4.10.4.2.2	Message Semantics .....	185
330	4.10.4.2.3	Expected Actions.....	185
	4.11	Image Availability Query [RAD-11] .....	186
	4.11.1	Scope .....	186
	4.11.2	Actor Roles.....	187
	4.11.3	Referenced Standards .....	187



---

335	4.11.4	Messages.....	187
	4.11.4.1	Query Image Availability .....	188
	4.11.4.1.1	Trigger Events.....	188
	4.11.4.1.2	Message Semantics .....	188
	4.11.4.1.3	Expected Actions .....	189
340	4.12	Patient Update [RAD-12] .....	190
	4.12.1	Scope .....	190
	4.12.2	Actor Roles .....	190
	4.12.3	Referenced Standards .....	190
	4.12.4	Messages.....	191
345	4.12.4.1	Patient Management – Patient Transfer.....	191
	4.12.4.1.1	Trigger Events.....	191
	4.12.4.1.2	Message Semantics .....	191
	4.12.4.1.2.1	Message Semantics (HL7 v2.3.1).....	192
	4.12.4.1.2.1.1	MSH Segment (HL7 v2.3.1) .....	192
350	4.12.4.1.2.1.2	EVN Segment (HL7 v2.3.1).....	192
	4.12.4.1.2.1.3	PID Segment (HL7 v2.3.1) .....	192
	4.12.4.1.2.1.4	PV1 Segment (HL7 v2.3.1).....	192
	4.12.4.1.2.2	Message Semantics (HL7 v2.5.1).....	193
	4.12.4.1.2.2.1	MSH Segment (HL7 v2.5.1) .....	194
355	4.12.4.1.2.2.2	EVN Segment (HL7 v2.5.1).....	194
	4.12.4.1.2.2.3	PID Segment (HL7 v2.5.1) .....	194
	4.12.4.1.2.2.4	PV1 Segment (HL7 v2.5.1).....	194
	4.12.4.1.2.2.5	ROL Segment (HL7 v2.5.1).....	195
	4.12.4.1.3	Expected Actions .....	195
360	4.12.4.2	Patient Management – Update Patient Class .....	195
	4.12.4.2.1	Trigger Events.....	195
	4.12.4.2.2	Message Semantics .....	196
	4.12.4.2.2.1	Message Semantics (HL7 v2.3.1).....	196
	4.12.4.2.2.1.1	MSH Segment (HL7 v2.3.1) .....	196
365	4.12.4.2.2.1.2	EVN Segment (HL7 v2.3.1).....	197
	4.12.4.2.2.1.3	PID Segment (HL7 v2.3.1) .....	197
	4.12.4.2.2.1.4	PV1 Segment (HL7 v2.3.1).....	197
	4.12.4.2.2.2	Message Semantics (HL7 v2.5.1).....	198
	4.12.4.2.2.2.1	MSH Segment (HL7 v2.5.1) .....	199
370	4.12.4.2.2.2.2	EVN Segment (HL7 v2.5.1).....	199
	4.12.4.2.2.2.3	PID Segment (HL7 v2.5.1) .....	199
	4.12.4.2.2.2.4	PV1 Segment (HL7 v2.5.1).....	200
	4.12.4.2.2.2.5	ROL Segment (HL7 v2.5.1).....	201
	4.12.4.2.3	Expected Actions .....	201
375	4.12.4.3	Patient Management – Patient Information Update.....	201
	4.12.4.3.1	Trigger Events.....	201
	4.12.4.3.2	Message Semantics .....	202
	4.12.4.3.2.1	Message Semantics (HL7 v2.3.1).....	202

---

	4.12.4.3.2.1.1	MSH Segment (HL7 v2.3.1) .....	202
380	4.12.4.3.2.1.2	EVN Segment (HL7 v2.3.1).....	203
	4.12.4.3.2.1.3	PID Segment (HL7 v2.3.1) .....	203
	4.12.4.3.2.1.4	PV1 Segment (HL7 v2.3.1).....	203
	4.12.4.3.2.1.5	AL1 Segment (HL7 v2.3.1).....	203
	4.12.4.3.2.1.6	OBX Segment (HL7 v2.3.1) .....	204
385	4.12.4.3.2.2	Message Semantics (HL7 v2.5.1).....	204
	4.12.4.3.2.2.1	MSH Segment (HL7 v2.5.1) .....	204
	4.12.4.3.2.2.2	EVN Segment (HL7 v2.5.1).....	204
	4.12.4.3.2.2.3	PID Segment (HL7 v2.5.1 Option) .....	204
	4.12.4.3.2.2.4	PV1 Segment (HL7 v2.5.1).....	205
390	4.12.4.3.2.2.5	OBX Segment (HL7 v2.5.1) .....	205
	4.12.4.3.2.2.6	AL1 Segment (HL7 v2.5.1).....	205
	4.12.4.3.3	Expected Actions .....	205
	4.12.4.4	Patient Management – Patient Merge .....	206
	4.12.4.4.1	Trigger Events.....	206
395	4.12.4.4.2	Message Semantics .....	206
	4.12.4.4.2.1	Message Semantics (HL7 v2.3.1).....	206
	4.12.4.4.2.1.1	MSH Segment (HL7 v2.3.1) .....	206
	4.12.4.4.2.1.2	EVN Segment (HL7 v2.3.1).....	207
	4.12.4.4.2.1.3	PID Segment (HL7 v2.3.1) .....	207
400	4.12.4.4.2.1.4	PV1 Segment (HL7 v2.3.1).....	207
	4.12.4.4.2.1.5	MRG Segment (HL7 v2.3.1).....	207
	4.12.4.4.2.2	Message Semantics (HL7 v2.5.1).....	208
	4.12.4.4.2.2.1	MSH Segment (HL7 v2.5.1) .....	208
	4.12.4.4.2.2.2	EVN Segment (HL7 v2.5.1).....	208
405	4.12.4.4.2.2.3	PID Segment (HL7 v2.5.1) .....	208
	4.12.4.4.2.2.4	PV1 Segment (HL7 v2.5.1).....	209
	4.12.4.4.2.2.5	MRG Segment (HL7 v2.5.1).....	209
	4.12.4.4.3	Expected Actions .....	210
	4.12.4.5	Patient Management – Cancel Patient Transfer/Discharge .....	210
410	4.12.4.5.1	Trigger Events.....	210
	4.12.4.5.2	Message Semantics .....	210
	4.12.4.5.2.1	Message Semantics (HL7 v2.3.1).....	210
	4.12.4.5.2.1.1	MSH Segment (HL7 v2.3.1) .....	211
	4.12.4.5.2.1.2	EVN Segment (HL7 v2.3.1).....	211
415	4.12.4.5.2.1.3	PID Segment (HL7 v2.3.1) .....	211
	4.12.4.5.2.1.4	PV1 Segment (HL7 v2.3.1).....	211
	4.12.4.5.2.2	Message Semantics (HL7 v2.5.1).....	212
	4.12.4.5.2.2.1	MSH Segment (HL7 v2.5.1) .....	212
	4.12.4.5.2.2.2	EVN Segment (HL7 v2.5.1).....	212
420	4.12.4.5.2.2.3	PID Segment (HL7 v2.5.1) .....	212
	4.12.4.5.2.2.4	PV1 Segment (HL7 v2.5.1).....	212
	4.12.4.5.3	Expected Actions .....	213

	4.13 Procedure Update [RAD-13] .....	214
	4.13.1 Scope .....	214
425	4.13.2 Actor Roles .....	214
	4.13.3 Referenced Standards .....	214
	4.13.4 Messages .....	214
	4.13.4.1 Trigger Events .....	216
	4.13.4.2 Message Semantics .....	216
430	4.13.4.2.1 Message Semantics (HL7 v2.3.1) .....	216
	4.13.4.2.2 Message Semantics (HL7 v2.5.1) .....	217
	4.13.4.3 Expected Actions .....	218
	4.14 Query Images [RAD-14] .....	219
	4.14.1 Scope .....	219
435	4.14.2 Actor Roles .....	219
	4.14.3 Referenced Standards .....	219
	4.14.4 Messages .....	219
	4.14.4.1 Query Images .....	220
	4.14.4.1.1 Trigger Events .....	220
440	4.14.4.1.2 Message Semantics .....	220
	4.14.4.1.2.1 Enterprise Identity Option .....	225
	4.14.4.1.3 Expected Actions .....	226
	4.15 Query Presentation States [RAD-15] .....	227
	4.15.1 Scope .....	227
445	4.15.2 Actor Roles .....	227
	4.15.3 Referenced Standards .....	227
	4.15.4 Messages .....	228
	4.15.4.1 Query for Grayscale Softcopy Presentation States .....	228
	4.15.4.1.1 Trigger Events .....	228
450	4.15.4.1.2 Message Semantics .....	228
	4.15.4.1.3 Expected Actions .....	229
	4.16 Retrieve Images [RAD-16] .....	230
	4.16.1 Scope .....	230
	4.16.2 Actor Roles .....	230
455	4.16.3 Referenced Standards .....	230
	4.16.4 Messages .....	230
	4.16.4.1 Retrieve Images .....	231
	4.16.4.1.1 Trigger Events .....	232
	4.16.4.1.2 Message Semantics .....	232
460	4.16.4.1.3 Expected Actions .....	232
	4.16.4.1.3.1 NM Image Profile .....	232
	4.16.4.1.3.2 Mammography Image Profile .....	232
	4.16.4.1.3.3 Basic Image Review Profile .....	233
	4.16.4.1.3.3.1 Basic Image Review Profile SOP Class Support .....	233
465	4.16.4.1.3.4 MR Diffusion Imaging Profile .....	234
	4.16.4.1.3.5 CT/MR Perfusion Imaging with Contrast Profile .....	234

---

	4.16.4.1.3.6 Intentionally Left Blank .....	234
	4.16.4.1.3.7 Digital Breast Tomosynthesis Profile .....	234
	4.16.4.2 View Images .....	235
470	4.16.4.2.1 Trigger Events.....	235
	4.16.4.2.2 Invocation Semantics .....	235
	4.16.4.2.2.1 Display of Digital X-Ray, Mammo and Intra-Oral Images .....	235
	4.16.4.2.2.1.1 Display of Digital Mammography Images.....	236
	4.16.4.2.2.1.2 Intentionally Left Blank .....	245
475	4.16.4.2.2.1.3 Display of DBT Images .....	245
	4.16.4.2.2.2 Display of Localizer Lines.....	255
	4.16.4.2.2.3 Display of NM Images.....	255
	4.16.4.2.2.3.1 Frame Selection Support.....	258
	4.16.4.2.2.3.2 Display Capabilities .....	259
480	4.16.4.2.2.3.3 Intensity and Color.....	262
	4.16.4.2.2.3.4 Image Zoom .....	263
	4.16.4.2.2.3.5 MPR Option .....	263
	4.16.4.2.2.3.6 General NM Option .....	263
	4.16.4.2.2.3.7 Cardiac NM Option.....	263
485	4.16.4.2.2.4 Display of Result Screens .....	264
	4.16.4.2.2.5 Intentionally Left Blank.....	264
	4.16.4.2.2.6 Display of Images for Basic Image Review .....	264
	4.16.4.2.2.6.1 Simple Restricted Feature Set .....	264
	4.16.4.2.2.6.2 Layout, Tiling, Selection, Rotation and Flipping.....	265
490	4.16.4.2.2.6.3 Navigation.....	266
	4.16.4.2.2.6.4 Windowing and Rendering .....	268
	4.16.4.2.2.6.5 Scrolling.....	270
	4.16.4.2.2.6.6 Zooming and Panning .....	271
	4.16.4.2.2.6.7 Laterality and Spatial Cross-Referencing .....	272
495	4.16.4.2.2.6.8 Annotation.....	273
	4.16.4.2.2.6.9 Cine .....	274
	4.16.4.2.2.6.10 Measurements .....	275
	4.16.4.2.2.6.11 Viewport and Tool Selection .....	275
	4.16.4.2.2.6.12 Report Display .....	276
500	4.16.4.2.2.6.13 Tool Icons and Actions .....	276
	4.16.4.2.3 Expected Actions .....	287
	4.16.4.2.3.1 NM Image Specifics .....	287
	4.17 Retrieve Presentation States [RAD-17] .....	289
	4.17.1 Scope .....	289
505	4.17.2 Actor Roles.....	289
	4.17.3 Referenced Standards .....	289
	4.17.4 Messages.....	290
	4.17.4.1 Retrieve Grayscale Softcopy Presentation State.....	290
	4.17.4.1.1 Trigger Events.....	291
510	4.17.4.1.2 Message Semantics .....	291

	4.17.4.1.3 Expected Actions .....	291
	4.17.4.2 View Presentation States.....	291
	4.17.4.2.1 Trigger Events.....	291
	4.17.4.2.2 Invocation Semantics .....	291
515	4.17.4.2.3 Expected Actions .....	292
	4.18 Creator Images Stored [RAD-18] .....	293
	4.18.1 Scope .....	293
	4.18.2 Actor Roles .....	293
	4.18.3 Referenced Standards .....	293
520	4.18.4 Messages.....	293
	4.18.4.1 Images Stored.....	293
	4.18.4.1.1 Trigger Events.....	293
	4.18.4.1.2 Message Semantics .....	294
525	4.18.4.1.2.1 Storage of Localizer Images (MR and CT).....	294
	4.18.4.1.2.2 Storage of NM Images (NM).....	294
	4.18.4.1.2.3 Storage of Cardiac Images (NM).....	294
	4.18.4.1.2.4 Result Screen Export Option .....	295
	4.18.4.1.2.5 Storage of DBT Reconstructions .....	297
	4.18.4.1.2.6 Enterprise Identity Option.....	297
530	4.18.4.1.2.7 Intentionally Left Blank.....	298
	4.18.4.1.3 Expected Actions .....	298
	4.18.4.1.3.1 DICOM Image Storage SOP Classes.....	299
	4.18.4.1.3.2 Enterprise Identity Option.....	299
	4.19 Creator Presentation State Stored [RAD-19].....	300
535	4.19.1 Scope .....	300
	4.19.2 Actor Roles .....	300
	4.19.3 Referenced Standards .....	300
	4.19.4 Messages.....	300
	4.19.4.1 Creator Presentation State Stored .....	301
540	4.19.4.1.1 Trigger Events.....	301
	4.19.4.1.2 Message Semantics .....	301
	4.19.4.1.3 Expected Actions .....	301
	4.20 Creator Procedure Step In Progress [RAD-20].....	302
	4.20.1 Scope .....	302
545	4.20.2 Actor Roles .....	302
	4.20.3 Referenced Standards .....	302
	4.20.4 Messages.....	303
	4.20.4.1 Procedure Step Started Message.....	303
	4.20.4.1.1 Trigger Event .....	303
550	4.20.4.1.2 Message Semantics .....	303
	4.20.4.1.2.1 Patient/Procedure/Procedure Step Information .....	303
	4.20.4.1.2.2 Required Attributes.....	303
	4.20.4.1.2.3 Relationship between Scheduled and Performed Procedure Steps..	304
	4.20.4.1.2.3.1 Append Case .....	304

---

555	4.20.4.1.2.4 Enterprise Identity Option.....	305
	4.20.4.1.3 Expected Actions .....	306
	4.21 Creator Procedure Step Completed [RAD-21] .....	307
	4.21.1 Scope .....	307
	4.21.2 Actor Roles .....	307
560	4.21.3 Referenced Standards .....	307
	4.21.4 Messages.....	307
	4.21.4.1 Procedure Step Completed/Discontinued .....	308
	4.21.4.1.1 Trigger Event .....	308
	4.21.4.1.2 Message Semantics .....	308
565	4.21.4.1.2.1 PPS Exception Management Option .....	308
	4.22 Intentionally Left Blank.....	309
	4.23 Print Request with Presentation LUT [RAD-23].....	310
	4.23.1 Scope .....	310
	4.23.2 Actor Roles .....	310
570	4.23.3 Referenced Standards .....	310
	4.23.4 Messages.....	311
	4.23.4.1 DICOM Film Session N-CREATE.....	311
	4.23.4.1.1 Trigger Events.....	312
	4.23.4.1.2 Message Semantics .....	312
575	4.23.4.1.3 Expected Actions .....	312
	4.23.4.2 DICOM Presentation LUT N-CREATE.....	312
	4.23.4.2.1 Trigger Events.....	312
	4.23.4.2.2 Message Semantics .....	312
	4.23.4.2.3 Expected Actions .....	313
580	4.23.4.2.4 User Specifiable Lighting Condition Option .....	313
	4.23.4.3 DICOM Film Box N-CREATE .....	313
	4.23.4.3.1 Trigger Events.....	313
	4.23.4.3.2 Message Semantics .....	313
	4.23.4.3.3 Expected Actions .....	314
585	4.23.4.4 DICOM Image Box N-SET .....	314
	4.23.4.4.1 Trigger Events.....	314
	4.23.4.4.2 Message Semantics .....	314
	4.23.4.4.3 Expected Actions .....	314
	4.23.4.5 DICOM Film Box N-ACTION.....	315
590	4.23.4.5.1 Trigger Events.....	315
	4.23.4.5.2 Message Semantics .....	315
	4.23.4.5.3 Expected Actions .....	315
	4.23.4.6 DICOM Film Session N-ACTION .....	315
	4.23.4.6.1 Trigger Events.....	315
595	4.23.4.6.2 Message Semantics .....	315
	4.23.4.6.3 Expected Actions .....	315
	4.23.4.7 Print Status (N-EVENT-REPORT) .....	316
	4.23.4.7.1 Trigger Events.....	316

---

	4.23.4.7.2 Message Semantics .....	316
600	4.23.4.7.3 Expected Actions .....	316
	4.23.4.8 Mammography Image and Digital Breast Tomosynthesis Profile .....	316
	4.24 Report Submission [RAD-24].....	319
	4.24.1 Scope .....	319
	4.24.2 Actor Roles.....	319
605	4.24.3 Referenced Standards .....	319
	4.24.4 Messages.....	319
	4.24.4.1 Report Creation.....	319
	4.24.4.1.1 Trigger Events.....	320
	4.24.4.1.2 Invocation Semantics .....	320
610	4.24.4.1.2.1 Coded Entries.....	320
	4.24.4.1.2.2 Retrieve AE Title.....	320
	4.24.4.1.2.3 Study Identification and Identical Documents Sequence .....	320
	4.24.4.1.3 Expected Actions .....	321
	4.24.4.2 Report Submission.....	321
615	4.24.4.2.1 Trigger Events.....	321
	4.24.4.2.2 Message Semantics .....	321
	4.24.4.2.3 Expected Actions .....	321
	4.25 Report Issuing [RAD-25].....	322
	4.25.1 Scope .....	322
620	4.25.2 Actor Roles.....	322
	4.25.3 Referenced Standards .....	322
	4.25.4 Messages.....	323
	4.25.4.1 Report Issuing (Step 1) .....	323
	4.25.4.1.1 Trigger Events.....	323
625	4.25.4.1.2 Message Semantics .....	323
	4.25.4.1.3 Expected Actions .....	324
	4.25.4.2 Report Modification.....	324
	4.25.4.2.1 Trigger Events.....	324
	4.25.4.2.2 Invocation Semantics .....	324
630	4.25.4.2.2.1 Retrieve AE Title.....	325
	4.25.4.2.2.2 Study Identification and Identical Documents Sequence .....	326
	4.25.4.2.3 Expected Actions .....	327
	4.25.4.3 Report Issuing (Step 2) .....	327
	4.25.4.3.1 Trigger Events.....	327
635	4.25.4.3.2 Message Semantics .....	328
	4.25.4.3.3 Expected Actions .....	328
	4.26 Query Reports [RAD-26].....	329
	4.26.1 Scope .....	329
	4.26.2 Actor Roles.....	329
640	4.26.3 Referenced Standards .....	329
	4.26.4 Messages.....	330
	4.26.4.1 Query Reports.....	330

---

	4.26.4.1.1 Trigger Events.....	330
	4.26.4.1.2 Message Semantics.....	331
645	4.26.4.1.3 Expected Actions.....	332
	4.27 Retrieve Reports [RAD-27].....	333
	4.27.1 Scope.....	333
	4.27.2 Actor Roles.....	333
	4.27.3 Referenced Standards.....	333
650	4.27.4 Messages.....	334
	4.27.4.1 Retrieve Reports.....	335
	4.27.4.1.1 Trigger Events.....	336
	4.27.4.1.2 Message Semantics.....	336
	4.27.4.1.3 Expected Actions.....	336
655	4.27.4.2 View Reports.....	336
	4.27.4.2.1 Trigger Events.....	336
	4.27.4.2.2 Invocation Semantics.....	336
	4.27.4.2.2.1 Retrieve AE Title.....	337
	4.27.4.2.3 Expected Actions.....	337
660	4.28 Structured Report Export [RAD-28].....	338
	4.28.1 Scope.....	338
	4.28.2 Actor Roles.....	338
	4.28.3 Messages.....	338
	4.28.3.1 Structured Report Export.....	338
665	4.28.3.1.1 Trigger Events.....	339
	4.28.3.1.2 Message Semantics.....	339
	4.28.4 DICOM SR to Structured Report Export Mapping.....	341
	4.28.5 Expected Actions.....	344
	4.29 Key Image Note Stored [RAD-29].....	344
670	4.29.1 Scope.....	344
	4.29.2 Actor Roles.....	345
	4.29.3 Referenced Standards.....	345
	4.29.4 Messages.....	345
	4.29.4.1 Key Image Note Stored Message.....	345
675	4.29.4.1.1 Trigger Events.....	345
	4.29.4.1.2 Message Semantics.....	346
	4.29.4.1.3 Expected Actions.....	346
	4.30 Query Key Image Notes [RAD-30].....	347
	4.30.1 Scope.....	347
680	4.30.2 Actor Roles.....	347
	4.30.3 Referenced Standards.....	347
	4.30.4 Messages.....	347
	4.30.4.1 Query Key Image Notes.....	347
	4.30.4.1.1 Trigger Events.....	348
685	4.30.4.1.2 Message Semantics.....	348
	4.30.4.1.3 Expected Actions.....	349

---





---

	4.36.4.1.2.1MSH Segment.....	368
	4.36.4.1.2.2EVN Segment .....	368
	4.36.4.1.2.3PID Segment .....	369
	4.36.4.1.2.4PV1 Segment .....	369
735	4.36.4.1.2.5DG1 Segment.....	369
	4.36.4.1.2.6GT1 Segment.....	370
	4.36.4.1.2.7IN1 Segment .....	372
	4.36.4.1.3 Expected Actions .....	373
	4.36.4.2 Account Management – Update Account .....	373
740	4.36.4.2.1 Trigger Events.....	373
	4.36.4.2.2 Message Semantics .....	374
	4.36.4.2.2.1MSH Segment.....	374
	4.36.4.2.2.2EVN Segment .....	374
	4.36.4.2.2.3PID Segment.....	375
745	4.36.4.2.2.4PV1 Segment .....	375
	4.36.4.2.2.5DG1 Segment.....	375
	4.36.4.2.2.6GT1 Segment.....	375
	4.36.4.2.2.7IN1 Segment .....	375
	4.36.4.2.3 Expected Actions .....	376
750	4.36.4.3 Account Management – End Account .....	376
	4.36.4.3.1 Trigger Events.....	376
	4.36.4.3.2 Message Semantics .....	376
	4.36.4.3.2.1MSH Segment.....	376
	4.36.4.3.2.2EVN Segment .....	376
755	4.36.4.3.2.3PID Segment.....	377
	4.36.4.3.2.4PV1 Segment .....	377
	4.36.4.3.3 Expected Actions .....	377
	4.37Query Post-Processing Worklist [RAD-37].....	377
	4.37.1 Scope .....	377
760	4.37.2 Actor Roles .....	378
	4.37.3 Referenced Standards .....	378
	4.37.4 Messages.....	378
	4.37.4.1 Query General Purpose Worklist Message .....	378
	4.37.4.1.1 Trigger Events.....	378
765	4.37.4.1.2 Message Semantics .....	378
	4.37.4.1.2.1 Matching Keys and Return Keys .....	379
	4.37.4.1.2.2 Examples for the Use of Matching Key Attributes .....	380
	4.37.4.1.2.3 Matching Keys and Return Keys .....	380
	4.37.4.1.3 Expected Actions .....	384
770	4.37.4.2 Receive General Purpose Worklist Message .....	384
	4.37.4.2.1 Trigger Events.....	384
	4.37.4.2.2 Message Semantics .....	384
	4.37.4.2.3 Expected Actions .....	385
	4.38Workitem Claimed [RAD-38] .....	385

---

775	4.38.1	Scope .....	385
	4.38.2	Actor Roles.....	385
	4.38.3	Referenced Standards .....	386
	4.38.4	Messages.....	386
	4.38.4.1	General Purpose Scheduled Procedure Step In Progress/Suspend Message	
780		386	
	4.38.4.1.1	Trigger Events.....	386
	4.38.4.1.2	Message Semantics .....	386
	4.38.4.1.3	Expected Actions .....	387
	4.39	Workitem Performed Procedure Step In Progress [RAD-39].....	387
785	4.39.1	Scope .....	387
	4.39.2	Actor Roles.....	387
	4.39.3	Referenced Standards .....	388
	4.39.4	Messages.....	388
	4.39.4.1	General Purpose Performed Procedure Step In Progress Message.....	388
790		4.39.4.1.1 Trigger Events.....	388
		4.39.4.1.2 Message Semantics .....	388
		4.39.4.1.3 Expected Actions .....	388
		4.39.4.1.3.1 Relationship between Scheduled and Performed Procedure Steps..	389
		4.39.4.1.3.1.1 Simple Case.....	389
795		4.39.4.1.3.1.2 Unscheduled Case .....	389
		4.39.4.1.3.1.3 Append Case .....	390
		4.39.4.1.3.1.4 Abandoned Case.....	390
	4.40	Workitem Performed Procedure Step Completed [RAD-40] .....	390
	4.40.1	Scope .....	390
800	4.40.2	Actor Roles.....	391
	4.40.3	Referenced Standards .....	391
	4.40.4	Messages.....	391
	4.40.4.1	General Purpose Performed Procedure Step Completed Message .....	392
		4.40.4.1.1 Trigger Events.....	392
805		4.40.4.1.2 Message Semantics .....	392
		4.40.4.1.3 Reporting Message Semantics .....	392
		4.40.4.1.4 Expected Actions .....	392
	4.41	Workitem Completed [RAD-41] .....	393
	4.41.1	Scope .....	393
810	4.41.2	Actor Roles.....	393
	4.41.3	Referenced Standards .....	393
	4.41.4	Messages.....	393
	4.41.4.1	General Purpose SPS Completed Message.....	394
		4.41.4.1.1 Trigger Events.....	394
815		4.41.4.1.2 Message Semantics .....	394
		4.41.4.1.3 Expected Actions .....	394
	4.42	Performed Work Status Update [RAD-42].....	395
	4.42.1	Scope .....	395

---

	4.42.2	Actor Roles .....	395
820	4.42.3	Referenced Standards .....	396
	4.42.4	Messages.....	397
	4.42.4.1	Post-Processing Performed Procedure Step Created/Updated Message.	398
	4.42.4.1.1	Trigger Events.....	398
	4.42.4.1.2	Message Semantics .....	398
825	4.42.4.1.3	Expected Actions .....	399
	4.43	Evidence Document Stored [RAD-43] .....	399
	4.43.1	Scope .....	399
	4.43.2	Actor Roles .....	399
	4.43.3	Referenced Standards .....	400
830	4.43.4	Messages.....	400
	4.43.4.1	Evidence Document Stored.....	400
	4.43.4.1.1	Trigger Events.....	400
	4.43.4.1.2	Message Semantics .....	400
	4.43.4.1.3	Expected Actions .....	401
835	4.43.4.1.3.1	Mammography Image Profile .....	401
	4.44	Query Evidence Documents [RAD-44] .....	402
	4.44.1	Scope .....	402
	4.44.2	Actor Roles .....	402
	4.44.3	Referenced Standards .....	402
840	4.44.4	Messages.....	402
	4.44.4.1	Query Evidence Documents .....	402
	4.44.4.1.1	Trigger Events.....	402
	4.44.4.1.2	Message Semantics .....	403
	4.44.4.1.3	Expected Actions .....	403
845	4.44.4.1.3.1	Mammography Image Profile .....	404
	4.45	Retrieve Evidence Documents [RAD-45] .....	404
	4.45.1	Scope .....	404
	4.45.2	Actor Roles .....	404
	4.45.3	Referenced Standards .....	404
850	4.45.4	Messages.....	405
	4.45.4.1	Retrieve Evidence Documents .....	405
	4.45.4.1.1	Trigger Events.....	405
	4.45.4.1.2	Message Semantics .....	405
	4.45.4.1.3	Expected Actions .....	405
855	4.45.4.2	Render Evidence Documents .....	406
	4.45.4.2.1	Trigger Events.....	406
	4.45.4.2.2	Invocation Semantics .....	406
	4.45.4.2.3	Expected Actions .....	406
	4.45.4.2.3.1	Mammography Image Profile .....	407
860	4.46	Query Reporting Worklist [RAD-46] .....	407
	4.46.1	Scope .....	407
	4.46.2	Actor Roles.....	407

---

	4.46.3	Referenced Standards .....	407
	4.46.4	Messages.....	408
865	4.46.4.1	Query General Purpose Worklist Message .....	408
	4.46.4.1.1	Trigger Events.....	408
	4.46.4.1.2	Message Semantics .....	408
	4.46.4.1.2.1	Matching Keys and Return Keys .....	408
	4.46.4.1.2.2	Examples for the Use of Matching Key Attributes .....	409
870	4.46.4.1.2.3	Matching Keys and Return Keys .....	410
	4.46.4.1.3	Expected Actions .....	413
	4.46.4.2	Receive General Purpose Worklist Message .....	413
	4.46.4.2.1	Trigger Events.....	413
	4.46.4.2.2	Message Semantics .....	413
875	4.46.4.2.3	Expected Actions .....	414
	4.47	Distribute Imaging Information on Media [RAD-47] .....	414
	4.47.1	Scope .....	414
	4.47.2	Actor Roles.....	414
	4.47.3	Referenced Standard .....	415
880	4.47.4	Messages .....	415
	4.47.4.1	Distribute Imaging Information on Media .....	415
	4.47.4.1.1	Trigger Events .....	416
	4.47.4.1.2	Message Semantics.....	416
	4.47.4.1.2.1	Media Filesystem and File Naming Restrictions .....	416
885	4.47.4.1.2.2	Content Organization Overview .....	416
	4.47.4.1.2.2.1	DICOM Content.....	417
	4.47.4.1.2.2.2	Web Content Option.....	417
	4.47.4.1.2.2.3	Optional Content .....	419
	4.47.4.1.2.2.4	Media Identification.....	420
890	4.47.4.1.2.3	Content Organization Detail .....	421
	4.47.4.1.2.3.1	DICOM Content.....	421
	4.47.4.1.2.3.2	Web Content Option .....	425
	4.47.4.1.2.3.3	Content when Grouping with XDM (IHE ITI Technical Framework) .....	426
895	4.47.4.1.3	Expected Actions .....	427
	4.47.4.1.3.1	Expected Actions Common to All Actors .....	428
	4.47.4.1.3.2	Image Display .....	428
	4.47.4.1.3.3	Report Reader .....	428
	4.47.4.1.3.4	Portable Media Importer .....	428
900	4.47.4.1.3.4.1	Grouping with XDM (IHE ITI Technical Framework) .....	429
	4.47.4.1.3.5	Print Composer .....	430
	4.47.4.1.3.6	Display .....	430
	4.47.4.1.4	Media Options .....	430
	4.47.4.1.4.1	DVD Media Option.....	430
905	4.47.4.1.4.2	USB Media Option .....	431
	4.48	Appointment Notification [RAD-48].....	432

---

	4.48.1 Scope .....	432
	4.48.2 Actor Roles.....	432
	4.48.3 Referenced Standard .....	432
910	4.48.4 Messages .....	433
	4.48.4.1 Appointment Notification - New Bookings .....	433
	4.48.4.1.1 Trigger Events .....	433
	4.48.4.1.2 Message Semantics.....	433
	4.48.4.1.2.1 MSH Segment.....	434
915	4.48.4.1.2.2 SCH Segment.....	434
	4.48.4.1.2.3 RGS Segment.....	435
	4.48.4.1.2.4 AIS Segment.....	436
	4.48.4.1.2.5 NTE Segment.....	437
	4.48.4.1.3 Expected Actions.....	437
920	4.48.4.2 Appointment Notification – Reschedule Bookings.....	437
	4.48.4.2.1 Trigger Events .....	437
	4.48.4.2.2 Message Semantics.....	438
	4.48.4.2.2.1 MSH Segment.....	438
	4.48.4.2.2.2 SCH, RGS, NTE Segments.....	438
925	4.48.4.2.2.3 AIS Segment .....	438
	4.48.4.2.3 Expected Actions.....	438
	4.48.4.3 Appointment Notification – Cancel Bookings .....	439
	4.48.4.3.1 Trigger Events .....	439
	4.48.4.3.2 Message Semantics.....	439
930	4.48.4.3.2.1 MSH Segment.....	439
	4.48.4.3.2.2 SCH, RGS, NTE Segments.....	439
	4.48.4.3.2.3 AIS Segment .....	439
	4.48.4.3.3 Expected Actions.....	440
	4.49 Instance Availability Notification [RAD-49] .....	440
935	4.49.1 Scope .....	440
	4.49.2 Actor Roles.....	440
	4.49.3 Referenced Standard .....	440
	4.49.4 Messages .....	441
	4.49.4.1 Instance Availability Notification .....	441
940	4.49.4.1.1 Trigger Events .....	441
	4.49.4.1.2 Message Semantics.....	442
	4.49.4.1.2.1 Intentionally Left Blank.....	443
	4.49.4.1.3 Expected Actions.....	443
	4.50 Store Instances [RAD-50].....	443
945	4.50.1 Scope .....	443
	4.50.2 Actor Roles.....	443
	4.50.3 Referenced Standard.....	443
	4.50.4 Messages.....	444
	4.50.4.1 Store Instances.....	444
950	4.50.4.1.1 Trigger Events .....	444

---

	4.50.4.1.2 Message Semantics.....	444
	4.50.4.1.3 Expected Actions.....	444
	4.51 Store Export Selection [RAD-51].....	444
955	4.51.1 Scope.....	444
	4.51.2 Actor Roles.....	445
	4.51.3 Referenced Standard.....	445
	4.51.4 Messages.....	445
	4.51.4.1 Store Export Selection.....	445
960	4.51.4.1.1 Trigger Events.....	445
	4.51.4.1.2 Message Semantics.....	446
	4.51.4.1.3 Expected Actions.....	448
	4.51.4.1.4 De-identification and Pseudonymization.....	448
	4.51.4.1.4.1 Baseline De-identification and Pseudonymization Requirements..	448
965	4.51.4.1.4.2 Manifest Coercion.....	450
	4.51.4.1.4.3 Remap Identifiers Option.....	450
	4.51.4.1.4.4 De-identify Pixel Data Option.....	451
	4.51.4.1.4.5 De-identification of Non-Image Instances.....	452
	4.51.4.1.5 Delay for Reason.....	452
	4.52 Store Additional Teaching File Information [RAD-52].....	452
970	4.52.1 Scope.....	452
	4.52.2 Actor Roles.....	452
	4.52.3 Referenced Standard.....	453
	4.52.4 Messages.....	453
	4.52.4.1 Store Additional Teaching File Information.....	453
975	4.52.4.1.1 Trigger Events.....	453
	4.52.4.1.2 Message Semantics.....	453
	4.52.4.1.3 Expected Actions.....	454
	4.53 Export Instances [RAD-53].....	454
980	4.53.1 Scope.....	454
	4.53.2 Actor Roles.....	454
	4.53.3 Referenced Standard.....	454
	4.53.4 Messages.....	455
	4.53.4.1 Export Instances.....	455
985	4.53.4.1.1 Trigger Events.....	455
	4.53.4.1.2 Message Semantics.....	455
	4.53.4.1.3 Expected Actions.....	455
	4.54 Provide and Register Imaging Document Set – DEPRECATED.....	456
	4.55 WADO Retrieve [RAD-55].....	456
990	4.55.1 Scope.....	456
	4.55.2 Actor Roles.....	456
	4.55.3 Referenced Standard.....	456
	4.55.4 Messages.....	457
	4.55.4.1 WADO Retrieve.....	457
	4.55.4.1.1 Trigger Events.....	457

---

995	4.55.4.1.2 Message Semantics.....	457
	4.55.4.1.2.1 Example of WADO Request-URI .....	459
	4.55.4.1.3 Expected Actions .....	459
	4.55.4.1.4 Audit Trail Trigger Events.....	460
	4.56 Spatial Registrations Stored [RAD-56].....	460
1000	4.57 Blending Presentation States Stored [RAD-57].....	460
	4.58 Retrieve Spatial Registrations [RAD-58] .....	460
	4.59 Import Procedure Step In Progress [RAD-59].....	460
	4.59.1 Scope .....	460
	4.59.2 Actor Roles .....	461
1005	4.59.3 Referenced Standards .....	461
	4.59.4 Messages.....	462
	4.59.4.1 Procedure Step In Progress Message .....	462
	4.59.4.1.1 Trigger Event .....	462
	4.59.4.1.2 Message Semantics .....	462
1010	4.59.4.1.2.1 Patient/Procedure/Scheduled Procedure Step Information.....	463
	4.59.4.1.2.2 Required Attributes.....	463
	4.59.4.1.2.3 Relationship between Scheduled and Performed Procedure Steps and the Imported DICOM Composite Object .....	463
	4.59.4.1.2.3.1 Scheduled Import Option .....	463
1015	4.59.4.1.2.3.2 Unscheduled Import Option .....	464
	4.59.4.1.2.3.3 Performed Protocol Sequence for Import.....	464
	4.59.4.1.3 Expected Actions .....	464
	4.60 Import Procedure Step Completed/Discontinued [RAD-60].....	465
	4.60.1 Scope .....	465
1020	4.60.2 Actor Roles .....	465
	4.60.3 Referenced Standards .....	465
	4.60.4 Messages .....	465
	4.60.4.1 Procedure Step Completed/Discontinued .....	466
	4.60.4.1.1 Trigger Event .....	466
1025	4.60.4.1.2 Message Semantics .....	466
	4.60.4.1.2.1 Retrieve AE Title.....	467
	4.60.4.1.2.2 Import PPS Exception Management.....	467
	4.60.4.1.2.3 Billing and Material Management Option.....	468
	4.60.4.1.3 Expected Actions .....	469
1030	4.60.4.1.3.1 Import PPS Exception Management.....	469
	4.60.4.1.3.2 Billing and Material Management Information Option.....	470
	4.61 Imported Objects Stored [RAD-61] .....	470
	4.61.1 Scope .....	470
	4.61.2 Actor Roles .....	470
1035	4.61.3 Referenced Standards .....	470
	4.61.4 Messages .....	471
	4.61.4.1 Evidence Objects Stored .....	471
	4.61.4.1.1 Trigger Events.....	471

---



	4.61.4.1.1.1UIDs.....	471
1040	4.61.4.1.2 Message Semantics .....	471
	4.61.4.1.2.1Original Attributes Sequence.....	472
	4.61.4.1.2.2Contributing Equipment Sequence .....	473
	4.61.4.1.3 Expected Actions .....	474
	4.61.4.1.3.1DICOM Storage SOP Classes .....	474
1045	4.62Store Dose Information [RAD-62] .....	474
	4.62.1 Scope .....	474
	4.62.2 Actor Roles.....	474
	4.62.3 Referenced Standard .....	474
	4.62.4 Messages .....	475
1050	4.62.4.1 Store Dose Information .....	475
	4.62.4.1.1 Trigger Events .....	475
	4.62.4.1.1.1Digitization .....	476
	4.62.4.1.2 Message Semantics.....	476
	4.62.4.1.2.1Cross-referencing Dose Objects and Image Objects .....	478
1055	4.62.4.1.3 Expected Actions.....	479
	4.63 Submit Dose Information [RAD-63] .....	479
	4.63.1 Scope .....	479
	4.63.2 Actor Roles.....	479
	4.63.3 Referenced Standard .....	479
1060	4.63.4 Messages .....	480
	4.63.4.1 Submit Dose Information Message .....	480
	4.63.4.1.1 Trigger Events .....	480
	4.63.4.1.2 Message Semantics.....	480
	4.63.4.1.2.1 De-identification .....	481
1065	4.63.4.1.3 Expected Actions.....	483
	4.63.4.2 Return Message Status .....	483
	4.63.4.2.1 Trigger Events .....	483
	4.63.4.2.2 Message Semantics.....	483
	4.63.4.2.3 Expected Actions .....	483
1070	4.63.5 Security Considerations.....	484
	4.63.5.1 Security Audit Considerations.....	484
	4.63.5.2 Transport Security .....	484
	4.64 Query Dose Information [RAD-64].....	484
	4.64.1 Scope .....	484
1075	4.64.2 Actor Roles.....	484
	4.64.3 Referenced Standard .....	484
	4.64.4 Messages .....	485
	4.64.4.1 Query Dose Information.....	485
	4.64.4.1.1 Trigger Events .....	485
1080	4.64.4.1.2 Message Semantics.....	486
	4.64.4.1.2.1 Filtering Strategies.....	487
	4.64.4.1.3 Expected Actions.....	488

	4.65 Retrieve Dose Information [RAD-65] .....	488
	4.65.1 Scope .....	488
1085	4.65.2 Actor Roles .....	489
	4.65.3 Referenced Standard .....	489
	4.65.4 Messages .....	489
	4.65.4.1 Retrieve Dose Information .....	489
	4.65.4.1.1 Trigger Events .....	490
1090	4.65.4.1.2 Message Semantics .....	490
	4.65.4.1.3 Expected Actions .....	490
	4.66 Rejection Note Stored [RAD-66] .....	491
	4.66.1 Scope .....	491
	4.66.2 Actor Roles .....	491
1095	4.66.3 Referenced Standards .....	492
	4.66.4 Messages .....	492
	4.66.4.1 Rejection Note Stored (for Quality Reasons) .....	492
	4.66.4.1.1 Trigger Events .....	492
	4.66.4.1.2 Message Semantics .....	492
1100	4.66.4.1.3 Expected Actions .....	493
	4.66.4.2 Rejection Note Stored (for Patient Safety Reasons) .....	494
	4.66.4.2.1 Trigger Events .....	494
	4.66.4.2.2 Message Semantics .....	495
	4.66.4.2.3 Expected Actions .....	495
1105	4.66.4.2.3.1 Additional Requirements for Image Manager/Archive in IOCM....	495
	4.66.4.3 Rejection Note Stored (for Incorrect Modality Worklist) .....	495
	4.66.4.3.1 Trigger Events .....	495
	4.66.4.3.2 Message Semantics .....	496
	4.66.4.3.3 Expected Actions .....	496
1110	4.66.4.4 Rejection Note Stored (for Data Retention Expiry) .....	496
	4.66.4.4.1 Trigger Events .....	496
	4.66.4.4.2 Message Semantics .....	496
	4.66.4.4.3 Expected Actions .....	497
	4.67 Media Information Stored [RAD-67] .....	497
1115	4.68 Provide and Register Imaging Document Set – MTOM/XOP [RAD-68] .....	497
	4.68.1 Scope .....	497
	4.68.2 Actor Roles .....	498
	4.68.3 Referenced Standards .....	498
	4.68.4 Messages .....	499
1120	4.68.4.1 Provide and Register Imaging Document Set – MTOM/XOP Request message .....	499
	4.68.4.1.1 Trigger Events .....	499
	4.68.4.1.2 Message Semantics .....	499
	4.68.4.1.2.1 Sharing of Set of DICOM Instances .....	500
1125	4.68.4.1.2.1.1 Manifest KOS Document .....	500
	4.68.4.1.2.2 Sharing of Report .....	501

---

	4.68.4.1.2.3 Document Sharing Metadata .....	502
	4.68.4.1.2.3.1 Metadata Attributes: Author Information and Document Creation Time .....	502
1130	4.68.4.1.2.3.2 DocumentEntry Metadata .....	503
	4.68.4.1.2.3.3 Transformation of DICOM VR to Document Sharing Metadata Data Types .....	506
	4.68.4.1.2.3.4 Document Sharing Metadata Values represented as HL7 v2.5 Data Types .....	509
1135	4.68.4.1.2.3.5 CDA Wrapper – CDA Wrapped Text Report Option .....	511
	4.68.4.1.2.4 Use of Document Sharing Submission Set .....	514
	4.68.4.1.2.4.1 Linking Report to Set of DICOM Instances .....	514
	4.68.4.1.2.4.2 Linking Report to prior report .....	515
	4.68.4.1.3 Expected Actions .....	516
1140	4.68.4.2 Provide and Register Imaging Document Set – MTOM/XOP Response message .....	516
	4.69 Retrieve Imaging Document Set [RAD-69] .....	516
	4.69.1 Scope .....	516
	4.69.2 Actor Roles .....	516
1145	4.69.3 Referenced Standards .....	516
	4.69.4 Messages .....	517
	4.69.4.1 Retrieve Imaging Document Set Request message .....	517
	4.69.4.1.1 Trigger Events .....	517
	4.69.4.1.2 Message Semantics .....	518
1150	4.69.4.1.3 Expected Actions .....	518
	4.69.4.2 Retrieve Imaging Document Set Response message .....	519
	4.69.4.2.1 Trigger Events .....	519
	4.69.4.2.2 Message Semantics .....	519
	4.69.4.2.3 Expected Actions .....	519
1155	4.69.4.3 Asynchronous Web Services Exchange Method .....	520
	4.69.5 Protocol Requirements .....	520
	4.69.5.1 Sample SOAP Messages .....	524
	4.69.5.1.1 Sample Retrieve Imaging Document Set SOAP Request .....	524
	4.69.5.1.1.1 Synchronous Web Services Exchange .....	524
1160	4.69.5.1.1.2 Asynchronous Web Services Exchange .....	525
	4.69.5.1.2 Sample Retrieve Document Set SOAP Response .....	526
	4.69.5.1.2.1 Synchronous Web Services Exchange .....	526
	4.69.5.1.2.2 Asynchronous Web Services Exchange .....	526
	4.70 Image Manager Instances Stored [RAD-70] .....	527
1165	4.71 Image Manager Storage Commitment [RAD-71] .....	527
	4.72 Image Manager Instances Query [RAD-72] .....	527
	4.73 Image Manager Instances Retrieval [RAD-73] .....	527
	4.74 Replacement Instances Stored [RAD-74] .....	527
	4.74.1 Scope .....	527
1170	4.74.2 Actor Roles .....	527

---

	4.74.3 Referenced Standard .....	527
	4.74.4 Messages .....	528
	4.74.4.1 Instances Stored.....	528
1175	4.74.4.1.1 Trigger Events .....	528
	4.74.4.1.2 Message Semantics.....	528
	4.74.4.1.2.1 Correction of Scheduled Procedure Information .....	529
	4.74.4.1.2.2 Maintenance of Instance Referential Integrity.....	531
	4.74.4.1.3 Expected Actions .....	532
1180	4.75 Cross Gateway Retrieve Imaging Document Set [RAD-75] .....	532
	4.75.1 Scope .....	532
	4.75.2 Actor Roles.....	532
	4.75.3 Referenced Standard .....	532
	4.75.4 Messages .....	532
1185	4.75.4.1 Cross Gateway Retrieve Imaging Document Set .....	532
	4.75.4.1.1 Trigger Events .....	533
	4.75.4.1.2 Message Semantics.....	533
	4.75.4.1.3 Expected Actions.....	533
	4.75.4.2 Asynchronous Web Service Method .....	533
1190	4.75.5 Protocol Requirements .....	534
	4.75.5.1 Sample SOAP Messages .....	535
	4.75.5.1.1 Sample Cross Gateway Retrieve Imaging Document Set SOAP Request .....	535
	4.75.5.1.1.1 Synchronous Web Services Exchange.....	535
	4.75.5.1.1.2 Asynchronous Web Services Exchange.....	536
1195	4.75.5.1.2 Sample Cross Gateway Retrieve Imaging Document Set SOAP Response .....	537
	4.75.5.1.2.1 Synchronous Web Services Exchange.....	537
	4.75.5.1.2.2 Asynchronous Web Services Exchange.....	537
1200	4.76 Query for Studies [RAD-76].....	538
	4.77 Query for Patient ID [RAD-77] .....	538
	4.78 Request Filling of Order [RAD-78].....	538
	4.79 Import Instructions Request [RAD-79].....	538
	4.80 [RAD-80] – [RAD-102].....	538
1205	4.103 Retrieve Imaging Report Template [RAD-103] .....	538
	4.103.1 Scope .....	538
	4.103.2 Actor Roles.....	538
	4.103.3 Referenced Standards.....	539
	4.103.4 Messages .....	539
1210	4.103.4.1 Request Template Message .....	539
	4.103.4.1.1 Trigger Events .....	539
	4.103.4.1.2 Message Semantics.....	540
	4.103.4.1.3 Expected Actions .....	540
	4.103.4.2 Template Response Message.....	541
	4.103.4.2.1 Trigger Events .....	541

1215	4.103.4.2.2 Message Semantics.....	541
	4.103.4.2.3 Expected Actions.....	541
	4.103.5 Security Considerations.....	542
	4.103.5.1 Security Audit Considerations.....	542
	4.104 Store Imaging Report Template [RAD-104].....	542
1220	4.104.1 Scope.....	542
	4.104.2 Actor Roles.....	542
	4.104.3 Referenced Standards.....	542
	4.104.4 Messages.....	543
	4.104.4.1 Send Template Message.....	543
1225	4.104.4.1.1 Trigger Events.....	543
	4.104.4.1.2 Message Semantics.....	543
	4.104.4.1.3 Expected Actions.....	544
	4.104.5 Security Considerations.....	545
	4.104.5.1 Security Audit Considerations.....	545
1230	4.105 Query Imaging Report Template [RAD-105].....	545
	4.105.1 Scope.....	545
	4.105.2 Actor Roles.....	546
	4.105.3 Referenced Standards.....	546
	4.105.4 Messages.....	546
1235	4.105.4.1 Query Templates Message.....	546
	4.105.4.1.1 Trigger Events.....	547
	4.105.4.1.2 Message Semantics.....	547
	4.105.4.1.3 Expected Actions.....	549
	4.105.4.2 Template Response Message.....	549
1240	4.105.4.2.1 Trigger Events.....	549
	4.105.4.2.2 Message Semantics.....	550
	4.105.4.2.3 Expected Actions.....	551
	4.105.5 Security Considerations.....	552
	4.105.5.1 Security Audit Considerations.....	552
1245	4.106 Invoke Image Display [RAD-106].....	552
	4.107 WADO-RS Retrieve [RAD-107].....	552
	4.107.1 Scope.....	552
	4.107.2 Actor Roles.....	552
	4.107.3 Referenced Standards.....	553
1250	4.107.4 Messages.....	554
	4.107.4.1 Get Instances Request Message.....	554
	4.107.4.1.1 Trigger Events.....	555
	4.107.4.1.2 Message Semantics.....	555
	4.107.4.1.2.1 Example of a Get Instances Request message.....	555
1255	4.107.4.1.3 Expected Actions.....	555
	4.107.4.1.3.1 XDS-I Backend Option.....	555
	4.107.4.2 Get Instances Response Message.....	555
	4.107.4.2.1 Trigger Events.....	555

---

	4.107.4.2.2 Message Semantics.....	556
1260	4.107.4.2.3 Expected Actions.....	556
	4.107.4.3 Get Metadata Request Message.....	556
	4.107.4.3.1 Trigger Events.....	556
	4.107.4.3.2 Message Semantics.....	556
	4.107.4.3.2.1 Example of a Get Metadata Request message.....	557
1265	4.107.4.3.3 Expected Actions.....	557
	4.107.4.3.3.1 XDS-I Backend Option.....	557
	4.107.4.4 Get Metadata Response Message.....	557
	4.107.4.4.1 Trigger Events.....	557
	4.107.4.4.2 Message Semantics.....	557
1270	4.107.4.4.3 Expected Actions.....	557
	4.107.4.5 Get Bulkdata Request Message.....	558
	4.107.4.5.1 Trigger Events.....	558
	4.107.4.5.2 Message Semantics.....	558
	4.107.4.5.2.1 Example of a Get Bulkdata Request message.....	558
1275	4.107.4.5.3 Expected Actions.....	558
	4.107.4.5.3.1 XDS-I Backend Option.....	558
	4.107.4.6 Get Bulkdata Response Message.....	558
	4.107.4.6.1 Trigger Events.....	559
	4.107.4.6.2 Message Semantics.....	559
1280	4.107.4.6.3 Expected Actions.....	559
	4.107.4.7 Get Rendered Instances Request Message.....	559
	4.107.4.7.1 Trigger Events.....	559
	4.107.4.7.2 Message Semantics.....	559
	4.107.4.7.2.1 Example of a Get Rendered Instances Request message.....	560
1285	4.107.4.7.3 Expected Actions.....	560
	4.107.4.7.3.1 XDS-I Backend Option.....	560
	4.107.4.8 Get Rendered Instances Response Message.....	560
	4.107.4.8.1 Trigger Events.....	560
	4.107.4.8.2 Message Semantics.....	560
1290	4.107.4.8.3 Expected Actions.....	561
	4.107.5 Security Considerations.....	561
	4.107.5.1 Security Audit Considerations.....	561
	4.108 Store Instances over the Web [RAD-108].....	561
	4.108.1 Scope.....	561
1295	4.108.2 Actor Roles.....	561
	4.108.3 Referenced Standards.....	562
	4.108.4 Messages.....	562
	4.108.4.1 Store Instances Message.....	562
	4.108.4.1.1 Trigger Events.....	562
1300	4.108.4.1.2 Message Semantics.....	563
	4.108.4.1.2.1 Capture Device Attribute Requirements.....	563
	4.108.4.1.2.2 Lightweight Modality Attribute Requirements.....	564

---

---

	4.108.4.1.2.3 Single-frame Image.....	565
	4.108.4.1.2.3.1 JPEG Storage Option .....	565
1305	4.108.4.1.2.3.2 PNG Storage Option .....	566
	4.108.4.1.2.4 Multi-frame Video .....	566
	4.108.4.1.2.4.1 MPEG4 Storage Option .....	566
	4.108.4.1.2.5 Evidence Document Storage Option.....	567
	4.108.4.1.2.6 DICOM Instance Storage Option.....	568
1310	4.108.4.1.3 Expected Actions .....	568
	4.108.4.1.3.1 PNG Storage Option .....	569
	4.108.4.2 Return Status Message .....	569
	4.108.4.2.1 Trigger Events .....	569
	4.108.4.2.2 Message Semantics.....	569
1315	4.108.4.2.3 Expected Actions .....	569
	4.108.5 Security Considerations.....	570
	4.108.5.1 Security Audit Considerations.....	570
	4.108.5.2 Transport Security .....	570
	4.109 Open Event Channel [RAD-109].....	570
1320	4.110 Store Radiopharmaceutical Activity Information [RAD-110].....	570
	4.110.1 Scope .....	570
	4.110.2 Actor Roles.....	570
	4.110.3 Referenced Standard .....	571
	4.110.4 Messages .....	571
1325	4.110.4.1 Store Radiopharmaceutical Dose Information .....	571
	4.110.4.1.1 Trigger Events .....	571
	4.110.4.1.2 Message Semantics.....	572
	4.110.4.1.2.1 Cross-referencing DICOM RRDSR Objects and Image Objects .	573
	4.110.4.1.3 Expected Actions .....	574
1330	4.111 [RAD-111] – [RAD-120].....	574
	4.121 Store Protocol [RAD-121] .....	574
	4.122 Query Protocol [RAD-122].....	574
	4.123 Retrieve Protocol [RAD-123] .....	574
	4.124 Transfer Multiple Events [RAD-124] .....	574
1335	4.125 Store Protocol Approval [RAD-125] .....	575
	4.126 Query Protocol Approval [RAD-126].....	575
	4.127 Retrieve Protocol Approval [RAD-127] .....	575
	4.128 Send Imaging Result [RAD-128].....	575
	4.129 QIDO-RS Query [RAD-129] .....	575
1340	4.129.1 Scope .....	575
	4.129.2 Actor Roles.....	575
	4.129.3 Referenced Standards.....	576
	4.129.4 Messages .....	576
	4.129.4.1 Query Objects Request Message .....	576
1345	4.129.4.1.1 Trigger Events .....	576
	4.129.4.1.2 Message Semantics.....	576

---

	4.129.4.1.2.1 XDS-I Backend Option.....	578
	4.129.4.1.2.2 Example of a Search transaction.....	578
	4.129.4.1.3 Expected Actions.....	578
1350	4.129.4.1.3.1 XDS-I Backend Option.....	579
	4.129.4.2 Query Objects Response Message.....	583
	4.129.4.2.1 Trigger Events.....	583
	4.129.4.2.2 Message Semantics.....	583
	4.129.4.2.3 Expected Actions.....	583
1355	4.129.5 Security Considerations.....	583
	4.129.5.1 Security Audit Considerations.....	583
	4.130 Get Encounter Imaging Context [RAD-130].....	583
	4.131 Store Encounter Images [RAD-131].....	583
	4.132 Notify of Imaging Results [RAD-132].....	584
1360	4.133 Query for Patient Studies [RAD-133].....	584
	4.134 Study Root Query for Patient ID [RAD-134].....	584
	4.135 Send Import Notification [RAD-135].....	584
	4.136 Display Analysis Results [RAD-136].....	584
	4.137 Query Analysis Results [RAD-137].....	584
1365	4.138 Store Contrast Information [RAD-138].....	584
	4.139 Query Contrast Information [RAD-139].....	584
	4.140 Retrieve Contrast Information [RAD-140].....	584
	4.141 Store Multimedia Report [RAD-141].....	584
	4.142 Display Multimedia Report [RAD-142].....	585
1370	4.143 Find Multimedia Report [RAD-143].....	585
	4.144 Retrieve Rendered Multimedia Report [RAD-144].....	585
	4.145 Send Procedural Observation [RAD-145].....	585



## 1375 **1 Introduction**

This document, Volume 2 of the IHE Radiology (RAD) Technical Framework, defines transactions used in IHE Radiology profiles.

### **1.1 Introduction to IHE**

1380 Integrating the Healthcare Enterprise (IHE) is an international initiative to promote the use of standards to achieve interoperability among health information technology (HIT) systems and effective use of electronic health records (EHRs). IHE provides a forum for care providers, HIT experts and other stakeholders in several clinical and operational domains to reach consensus on standards-based solutions to critical interoperability issues.

1385 The primary output of IHE is system implementation guides, called IHE Profiles. IHE publishes each profile through a well-defined process of public review and trial implementation and gathers profiles that have reached final text status into an IHE Technical Framework, of which this volume is a part.

1390 For more general information regarding IHE, refer to [www.ihe.net](http://www.ihe.net). It is strongly recommended that, prior to reading this volume, the reader familiarizes themselves with the concepts defined in the [IHE Technical Frameworks General Introduction](#).

### **1.2 Intended Audience**

The intended audience of IHE Technical Frameworks Volume 2 is:

- IT departments of healthcare institutions
- Technical staff of vendors participating in the IHE initiative
- 1395 • Experts involved in standards development

### **1.3 Overview of Technical Framework Volume 2**

Volume 2 is comprised of several distinct sections:

- **Section 1** provides background and reference material.
- **Section 2** presents the conventions used in this volume to define the transactions.
- 1400 • **Section 3** provides an overview of the concepts of IHE actors and transactions used in IHE to define the functional components of a distributed healthcare environment.
- **Section 4** defines transactions in detail, specifying the roles for each actor, the standards employed, the information exchanged, and in some cases, implementation options for the transaction.
- 1405 • **Volume 2x** contains appendices to this volume that provide clarification of technical details of the IHE data model and transactions.

Due to the length of the document, some domains may divide Volume 2 into smaller volumes labeled 2a, 2b, etc. In this case, the Volume 2 appendices are gathered in Volume 2x.

1410 Code and message samples may also be stored on the IHE Google Drive at <https://drive.google.com/drive/folders/1aHW4ChzRzaYSoyewi9zGIRHwVpHgXQst>. In this case, explicit links to Google Drive will be provided in the transaction text.

For a brief overview of additional Technical Framework Volumes (TF-1, TF-3, TF-4), please see the IHE Technical Frameworks General Introduction, [Section 5 - Structure of the IHE Technical Frameworks](#).

1415 A glossary of terms and acronyms used in the IHE Technical Framework, including those from relevant standards, is provided in IHE Technical Frameworks General Introduction, [Appendix D](#).

## 1.4 Comment Process

1420 IHE International welcomes comments on this document and the IHE initiative. Comments on the IHE initiative can be submitted by sending an email to the co-chairs and secretary of the Radiology domain committees at [radiology@ihe.net](mailto:radiology@ihe.net). Comments on this document can be submitted at [https://www.ihe.net/Radiology\\_Public\\_Comments](https://www.ihe.net/Radiology_Public_Comments).

## 1.5 Copyright Licenses

1425 IHE technical documents refer to, and make use of, a number of standards developed and published by several standards development organizations. Please refer to the IHE Technical Frameworks General Introduction, [Section 9 - Copyright Licenses](#) for copyright license information for frequently referenced base standards. Information pertaining to the use of IHE International copyrighted materials is also available there.

## 1.6 Trademark

1430 IHE<sup>®</sup> and the IHE logo are trademarks of the Healthcare Information Management Systems Society in the United States and trademarks of IHE Europe in the European Community. Please refer to the IHE Technical Frameworks General Introduction, [Section 10 - Trademark](#) for information on their use.

## 1.7 Disclaimer Regarding Patent Rights

1435 Attention is called to the possibility that implementation of the specifications in this document may require use of subject matter covered by patent rights. By publication of this document, no position is taken with respect to the existence or validity of any patent rights in connection therewith. IHE International is not responsible for identifying Necessary Patent Claims for which a license may be required, for conducting inquiries into the legal validity or scope of Patents Claims or determining whether any licensing terms or conditions provided in connection with  
1440 submission of a Letter of Assurance, if any, or in any licensing agreements are reasonable or non-discriminatory. Users of the specifications in this document are expressly advised that determination of the validity of any patent rights, and the risk of infringement of such rights, is entirely their own responsibility. Further information about the IHE International patent disclosure process including links to forms for making disclosures is available at

1445 [http://www.ihe.net/Patent\\_Disclosure\\_Process](http://www.ihe.net/Patent_Disclosure_Process). Please address questions about the patent disclosure process to the secretary of the IHE International Board: [secretary@ihe.net](mailto:secretary@ihe.net).

## 1.8 History of Document Changes

This section provides a brief summary of changes and additions to this document.

Date	Document Revision	Change Summary
2020-09	19.0	Integrate Scheduled Workflow.b as a Final Text Profile. Integrate the DBT Extensions Supplement into Final Text. Incorporate <a href="#">Change Proposals</a> from 2019 CP Ballots. Refer to the <a href="#">IHE RAD CP Tracking Sheet</a> and IHE Radiology’s <a href="#">Incorporated CPs</a> for details. Update TF Volumes to move all transaction definitions to Volume 2 and align Volume 3 with the current template.
2022-03-10	20.0	Integrate Management of Radiology Report Templates (MRRT) as a Final Text Profile. Incorporate <a href="#">Change Proposals</a> from 2020-2021 CP Ballots. Refer to the <a href="#">IHE RAD CP Tracking Sheet</a> and IHE Radiology’s <a href="#">Incorporated CPs</a> for details.
2023-06	21.0	Integrate Radiation Exposure Monitoring for Nuclear Medicine (REM-NM) as a Final Text profile Incorporate <a href="#">Change Proposals</a> from CP Ballot 2023A and CP-RAD-460. Refer to the <a href="#">IHE RAD CP Tracking Sheet</a> and IHE Radiology’s <a href="#">Incorporated CPs</a> for details.
2024-06	22.0	Integrate the following as Final Text: <ul style="list-style-type: none"> <li>• Basic Image Review (BIR) Profile</li> <li>• Web-based Image Capture (WIC) Profile</li> <li>• Web-based Image Access (WIA) Profile</li> <li>• Cardiac Option into the Nuclear Medicine Imaging (NMI) Profile</li> </ul> Incorporate <a href="#">Change Proposals</a> from CP Ballot 2023B and 2024 A. Refer to the <a href="#">IHE RAD CP Tracking Sheet</a> and IHE Radiology’s <a href="#">Incorporated CPs</a> for details

## 1450 2 Conventions

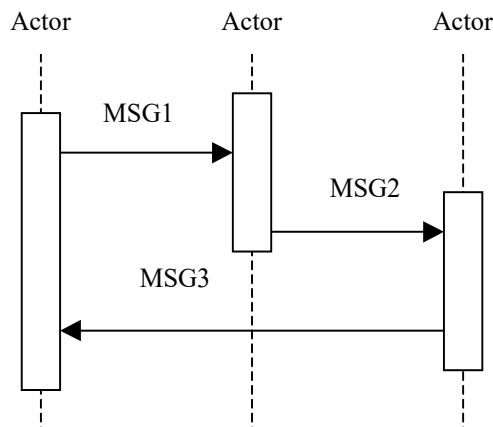
This document has adopted the following conventions for representing the framework concepts and specifying how the standards upon which the IHE Technical Framework is based shall be applied.

### 2.1 The Generic IHE Transaction Model

1455 Transaction descriptions are provided in Section 4. In each transaction description, the actors, the roles they play, and the transactions between them are presented as use cases.

The generic IHE transaction description includes the following components:

- *Scope*: a brief description of the transaction.
- *Use case roles*: textual definitions of the actors and their roles, with a simple diagram relating them, e.g.,:
- *Referenced Standards*: the standards (stating the specific parts, chapters or sections thereof) to be used for the transaction.
- *Interaction Diagram*: a graphical depiction of the actors and transactions, with related processing within an actor shown as a rectangle and time progressing downward, similar to:



1470 The interaction diagrams used in the IHE Technical Framework are modeled after those described in Grady Booch, James Rumbaugh, and Ivar Jacobson, *The Unified Modeling Language User Guide*, ISBN 0-201-57168-4. Simple acknowledgment messages are omitted from the diagrams for brevity.

- *Message definitions*: descriptions of each message involved in the transaction, the events that trigger the message, its semantics, and the actions that the message triggers in the receiver.

## 1475 2.2 DICOM Usage Conventions

For some DICOM transactions described in this document, IHE has strengthened the requirements on the use of selected Type 2 and Type 3 attributes. These situations are explicitly documented in the transaction specifications in Volume 2 and in the appendices in Volume 2x.

1480 IHE specifically emphasizes that DICOM Type 2 attributes (for instance, Patient Name, Patient ID) shall be transmitted with zero length if the source system does not possess valid values for such attributes; in other words, the source system shall not assign default values to such attributes. The receiving system must be able to handle zero-length values for such attributes.

IHE has defined requirements related to the support for and use of attributes in DICOM storage transactions by both Service Class Users (SCUs) and Service Class Providers (SCPs):

- 1485 • **O** The attribute or its value is optional, i.e., in DICOM it is Type 2 or 3.
- **R** The attribute is required, and is not an IHE extension of the DICOM requirements; i.e., it is already Type 1 in DICOM, but additional constraints are placed by IHE, for example on the value set that may be used for the attribute.
- 1490 • **R+** The Requirement is an IHE extension of the DICOM requirements, and the attribute shall be present with a value in images created by the Acquisition Modality, i.e., is Type 1, whereas the DICOM requirement may be Type 2 or 3.
- **RC+** The Requirement is an IHE extension of the DICOM requirements, and the attribute shall be present with a value in images created by the Acquisition Modality when the condition is satisfied, i.e., is Type 1C, whereas the DICOM requirement may be 1495 Type 2 or 3.

IHE has also defined requirements related to the support for and use of matching and return keys in DICOM queries by both Service Class Users (SCUs) and Service Class Providers (SCPs). Matching keys are used to select instances for inclusion in the response by the query SCP to the SCU, whereas return keys only return specific data and are not used for matching.

- 1500 • Required matching key SCU:  
A key that the Query SCU shall have the ability to offer to its user as a selection criterion. The definition of the means offered to the user of the Query SCU to trigger the sending of a matching key in the Query request is beyond the scope of IHE (e.g., enter a value, select an entry). A Query SCU shall include as a Matching Key in each C-FIND request 1505 all attributes specified as R or R+ for which the user provided a value. If the user does not provide a value, the Query SCU shall send the attribute zero-length (i.e., as a Return Key).

- Required matching key SCP:  
 1510 An IHE required matching key is processed by the Query SCP just as if it were a DICOM-required matching key. In most cases, IHE-required matching keys are also DICOM-required matching keys.
- Required return key SCU:  
 1515 A key that the Query SCU requests from the Query SCP and receives in the query responses. The definition of the means offered to the user of the Query SCU to request a return key (e.g., by default, check a box) and to make it visible to the user is beyond the scope of IHE. A Query SCU shall include as Return Keys in each C-FIND request all attributes specified as R, R+, R\*, or R+\*. A Query SCU shall display for the user the returned value of all attributes specified as R or R+ in the normal user interface.
- Required return key SCP:  
 1520 IHE-required return keys specified within DICOM as type 1 or type 2 return keys are processed according to their DICOM type. IHE-required return keys specified within DICOM as type 3 will be processed as if they were type 2.

Query Key Requirement Tables in the framework use the following legend to specify requirements for SCUs and SCPs:

- 1525 • **R** Required
- **O** Optional

The following modifiers are also used:

- **R+** The Requirement is an IHE extension of the DICOM requirements
- **R\*** The attribute is not required to be displayed
- 1530 • **R+\*** The Requirement is an IHE extension of the DICOM requirements, but the attribute is NOT required to be displayed

Table 2.2-1 provides an example table defining matching and return keys. Note that sequence attributes are used as a structuring header in these matching and return key tables, and requirements are given for individual sequence items.

1535 **2.2-1: Images Query Matching and Return Keys**

Attributes Name	Tag	Query Keys Matching		Query Keys Return		Notes
		SCU	SCP	SCU	SCP	
Scheduled Human Performers Sequence	(0040,4034)					
>Human Performer Code Sequence	(0040,4009)					
>>Code Value	(0008,0100)	R+	R	R+*	R	

Attributes Name	Tag	Query Keys Matching		Query Keys Return		Notes
		SCU	SCP	SCU	SCP	
>>Coding Scheme Designator	(0008,0102)	R+	R	R+*	R	
>>Code Meaning	(0008,0104)	-	-	R+	R	Query Keys Matching SCU or SCP do not use the Code Meaning values (“-“).
>Human Performer's Name	(0040,4037)	R+	R+	R+	R+	
>Human Performer's Organization	(0040,4036)	O	O	O	R+	
Input Information Sequence	(0040,4021)					
>Study Instance UID	(0020,000D)	O	O	R+*	R	
...	...	...	...	...	...	...

## 2.3 HL7 Profiling Conventions

The HL7 tables included in this document have been modified from the corresponding HL7 standard documents. Such a modification is called a profile using static definitions as described for HL7 constrainable message profiles; refer to HL7 v2.5.1, Chapter 2, Section 2.12.6.

1540 The static definition of an IHE-profiled message is represented within tables in the Technical Framework. The message level table represents the IHE-profiled message structure with its list of usable segments. The segment level table represents the IHE-profiled content of one segment with its usable fields.

### 2.3.1 Static definition – Segment level and Data Type level

1545 The Segment table and the Data Type table each contain 8 columns (HL7 v2.3.1 messages use only 7 columns) as described below:

- **SEQ:** Position (sequence) of the field within the segment.
- **LEN:** Maximum length of the field.

1550 Since version 2.5, the HL7 standard also defines the maximum length of each component with a field. IHE profiled HL7 messages shall conform to the HL7 standard if not otherwise stated in this Technical Framework.

- **DT:** Field Data Type
- **Usage:** Usage of the field (column noted as **OPT** in HL7 v2.3.1 message static definition.)

1555 The coded values used in this column are:

- 1560 **R:** Required: A compliant sending application shall populate all "R" elements with a non-empty value. A compliant receiving application may ignore the information conveyed by required elements. A compliant receiving application shall not raise an error due to the presence of a required element, but may raise an error due to the absence of a required element.
- R+:** Required as IHE extension: This is a field optional in the original HL7 standard but required in the IHE-profiled messages. Only HL7 v2.3.1 messages use this notation to indicate the difference between OPT in the IHE profiles and in the base HL7 standard.
- 1565 **RE:** Required but may be empty. ("R2" in HL7 v2.3.1 messages)
- The element may be missing from the message, but shall be sent by the sending application if there is relevant data. A conformant sending application shall be capable of providing all "RE" elements. If the conformant sending application knows a value for the element, then it shall send that value. If the conformant sending application does not know a value, then that element may be omitted.
- 1570 Receiving applications may ignore data contained in the element, but shall be able to successfully process the message if the element is omitted (no error message should be generated if the element is missing).
- 1575 **O:** Optional. The usage for this field within the message is not defined. The sending application may choose to populate the field; the receiving application may choose to ignore the field.
- C:** Conditional. This usage has an associated condition predicate. (See HL7 v2.5.1, Chapter 2, Section 2.12.6.6, "Condition Predicate".)
- 1580 If the predicate is satisfied: A compliant sending application shall populate the element. A compliant receiving application may ignore data in the element. It may raise an error if the element is not present.
- If the predicate is NOT satisfied: A compliant sending application shall NOT populate the element. A compliant receiving application shall NOT raise an error if the condition predicate is false and the element is not present, though it may raise an error if the element IS present.
- 1585 The condition predicate is not explicitly defined when it depends on functional characteristics of the system implementing the transaction and it does not affect data consistency.
- 1590 **CE:** Conditional but may be empty. This usage has an associated condition predicate. (See HL7 Version 2.5, Chapter 2, Section 2.12.6.6, "Condition Predicate".)
- 1595 If the conforming sending application knows the required values for the element, then the application must populate the element. If the conforming sending application does not know the values required for this element, then the element shall be omitted. The conforming sending application must be capable of populating the element (when the predicate is true) for all 'CE' elements. If the element is present, the conformant



receiving application may ignore the values of that element. If the element is not present, the conformant receiving application shall not raise an error due to the presence or absence of the element.

1600

If the predicate is NOT satisfied: The conformant sending application shall not populate the element. The conformant receiving application may raise an application error if the element is present.

**X:** Not supported. For conformant sending applications, the element will not be sent. Conformant receiving applications may ignore the element if it is sent, or may raise an application error.

1605

- **Cardinality:** Minimum and maximum number of occurrences for the field in the context of this Transaction.
  - This column is not used in IHE-profiled HL7 v2.3.1 messages.
- **TBL#:** Table reference (for fields using a set of defined values)
- **ITEM#:** HL7 unique reference for this field

1610

- **Element Name:** Name of the field in a Segment table. / Component Name: Name of a subfield in a Data Type table.

Table 2.3-1 provides a sample profile for an imaginary HL7 segment. Tables for actual segments are copied from the corresponding HL7 standard versions with modifications made only to the OPT (Usage) column.

1615

**Table 2.3-1: Sample HL7 Profile**

SEQ	LEN	DT	OPT	TBL#	ITEM #	ELEMENT NAME
1	1	ST	R		xx001	Element 1
2	4	ST	O		xx002	Element 2
3	180	HD	R2		xx003	Element 3
4	180	HD	C		xx004	Element 4
5	180	HD	O		xx005	Element 5
6	180	HD	R		xx006	Element 6

Note: This sample table is made for HL7 v2.3.1 message definition in this Technical Framework. For HL7 v2.5.1, one more column “Cardinality” will be added between columns OPT and TBL#.

1620

The lengths of the fields specified in the **LEN** column of profiling tables shall be interpreted in accordance with HL7 standard, where it indicates the calculated length of the single occurrence of the field based on the expected maximum lengths of its individual components.

1625

As such, IHE requires that the receiving actors are able to properly process the fields where each occurrence is up to the maximum length specified in the HL7 profiling tables. Sending actors shall be able to generate messages where single occurrences of fields do not exceed maximum lengths specified in the profiling tables. Both receiving and sending actors shall take into account the mapping of values between HL7 and DICOM (see Section 2.5) so that values of components that are mapped into DICOM do not exceed length limitations of that standard.

Handling of fields with single occurrence longer than maximum length is out of scope of IHE specifications.

### 2.3.2 Static definition - Message level

1630 The message table representing the static definition contains 5 columns (HL7 v2.3.1 messages use only 3 columns) as described below:

- **Segment:** gives the segment name, and places the segment within the hierarchy of the message structure designed by HL7.
  - The beginning and end lines of a segment group (see HL7 v2.5.1, Chapter 2, Section 2.5.2 for definition) are designated in this column by --- (3 dashes). The square brackets and braces that designate optionality and repeatability are hidden.
- 1635 • **Meaning:** Meaning of the segment as defined by HL7.
- **Usage:** Usage of the segment. Same coded values used in the segment level: R, RE, O, C, CE, and X (see Section 2.3.1).
  - 1640 ○ This column is not used in HL7 v2.3.1 messages.
- **Cardinality:** Minimum and maximum number of occurrences authorized for this segment in the context of the IHE-profiled HL7 message.
  - This column is not used in HL7 v2.3.1 messages.

**HL7 chapter:** Reference of the HL7 standard document chapter that describes this segment.

## 1645 2.4 HL7 Implementation Notes

This section describes the guidance and requirements for the general aspects of implementing IHE-profiled HL7 messages, e.g., message control, acknowledgement, version policy and network associations. Section 2.4.1 lists common requirements for HL7 messages of all versions supported in this Technical Framework, followed by specific requirements for each supported version in individual sections starting from Section 2.4.2.

1650

### 2.4.1 Common HL7 Message Implementation Requirements

Systems implementing IHE-profiled HL7 messages shall do so according to the HL7 Standard unless otherwise specified in Section 2.4 or the specific transaction.

#### 2.4.1.1 Network Guidelines

1655 The HL7 standards do not define a network communications protocol. The HL7 v2.1 standard defines lower layer protocols in its Appendix C. These definitions were moved to the Implementation Guide in 2.2 and subsequent versions, but are not HL7 requirements. The IHE Framework makes these recommendations:

1. Applications shall use the Minimal Lower Layer Protocol defined in Appendix C of the  
1660 HL7 Implementation Guide.

2. An application that wants to send a message (initiate a transaction) will initiate a network connection to start the transaction. The receiver application will respond with an acknowledgement or response to query but will not initiate new transactions on this network connection.

#### 1665 **2.4.1.2 Acknowledgement Mode**

Applications that receive HL7 messages shall send acknowledgments using the HL7 Original Mode (versus Enhanced Acknowledgment Mode) unless otherwise specified in an IHE RAD transaction.

#### **2.4.1.3 HL7 Versioning**

1670 The selection of a particular version of HL7 for any given HL7 based transaction within the Technical Framework is based upon a number of factors. These include:

- Whether the version of HL7 provides the functionality needed for the transaction.
- How widely the version of HL7 is supported at the time of specification

1675 Since the transactions are self-contained communications, the implementation of each HL7 transaction may use a different version of HL7.

1680 An application implementing an IHE transaction with HL7 messages must comply with the message structure and contents defined by the specified version(s) of the HL7 standard as defined in the transaction technical specification, as well as in this section. It is acceptable if the HL7 standard version value (MSH-12) in a conformant message is higher than that specified in the transaction specification of the Technical Framework as long as the message structure and contents meet the requirements of the specification.

#### **2.4.1.4 Empty Field**

1685 According to the HL7 standard, if the value of a field is not present, the receiver shall not change corresponding data in its database. However, if sender includes explicit NULL value (i.e., two double-quotes ""), it shall cause removal of any values for that field in the receiver's database.

#### **2.4.1.5 Z-Segment**

IHE prohibits sending Z-segments unless one is defined for a transaction in the IHE Technical Framework.

### **2.4.2 HL7 v2.3.1 Message Implementation Requirements**

#### 1690 **2.4.2.1 Acknowledgement Message**

1695 The IHE Technical Framework provides for each HL7 message to be acknowledged by the HL7 ACK message sent by the receiver of an HL7 message to its sender. The segments of the ACK message listed below are required, and their detailed descriptions are provided in the following subsections. The ERR segment is optional and may be included if the *MSA-1 Acknowledgment Code* field identifies an error condition.

**Table 2.4-1: Common ACK Message static definition**

Segment	Meaning	HL7 chapter
MSH	Message Header	2
MSA	Message Acknowledgement	2
[ERR]	Error	2

*Adapted from the HL7 Standard, version 2.3.1*

### 2.4.2.2 Message Control

1700 The MSH (message header) segment contains control information set in the beginning of each message sent.

**Table 2.4-2: IHE Profile - MSH segment**

SEQ	LEN	DT	OPT	TBL#	ITEM #	ELEMENT NAME
1	1	ST	R		00001	Field Separator
2	4	ST	R		00002	Encoding Characters
3	180	HD	R+		00003	Sending Application
4	180	HD	R+		00004	Sending Facility
5	180	HD	R+		00005	Receiving Application
6	180	HD	R+		00006	Receiving Facility
7	26	TS	R		00007	Date/Time Of Message
8	40	ST	O		00008	Security
9	13	CM	R	0076/ 0003	00009	Message Type
10	20	ST	R		00010	Message Control ID
11	3	PT	R		00011	Processing ID
12	60	VID	R	0104	00012	Version ID
13	15	NM	O		00013	Sequence Number
14	180	ST	O		00014	Continuation Pointer
15	2	ID	O	0155	00015	Accept Acknowledgment Type
16	2	ID	O	0155	00016	Application Acknowledgment Type
17	3	ID	O	0399	00017	Country Code
18	16	ID	C	0211	00692	Character Set
19	250	CE	O		00693	Principal Language Of Message
20	20	ID	O	0356	01317	Alternate Character Set Handling Scheme

*Adapted from the HL7 Standard, version 2.3.1*

IHE requires that applications support HL7-recommended values for the fields *MSH-1-Field Separator* and *MSH-2-Encoding Characters*.

1705 Field *MSH-18-Character Set* shall only be valued if the message utilizes character sets other than ISO IR-6, also known as ASCII.

Implementations supporting sequence number protocol (and using the field *MSH-13-Sequence Number*) shall be configurable to allow them to perform transactions without such protocol.

### 2.4.2.3 Acknowledgement Modes

1710 This segment contains information sent while acknowledging another message.

**Table 2.4-3: IHE Profile - MSA segment**

SEQ	LEN	DT	OPT	TBL#	ITEM#	ELEMENT NAME
1	2	ID	R	0008	00018	Acknowledgment Code
2	20	ST	R		00010	Message Control ID
3	80	ST	O		00020	Text Message
4	15	NM	O		00021	Expected Sequence Number
5	1	ID	O	0102	00022	Delayed Acknowledgment Type
6	100	CE	O		00023	Error Condition

*Adapted from the HL7 standard, version 2.3.1*

Field *MSA-1 Acknowledgement Code* shall contain the value AA, AE or AR when using Original Acknowledgement Mode, or CA, CE or CR when using Enhanced Acknowledgement Mode. See 1715 HL7 v2.3.1 Chapter 2 Section 2.2.2, 2.2.3 and 2.24.2.1 for details.

Field *MSA-2 Message Control ID* shall contain the Message ID from the *MSH-10 Message Control ID* of the incoming message for which this acknowledgement is sent.

### 2.4.2.4 ERR – Error Segment

1720 This segment contains information sent while field MSA-1 (acknowledgement code) identifies an error condition.

**Table 2.4-4: IHE Profile - ERR segment**

SEQ	LEN	DT	OPT	TBL#	ITEM#	ELEMENT NAME
1	80	ID	R		00024	Error code and location

*Adapted from the HL7 standard, version 2.3.1*

### 2.4.3 HL7 v2.4 Message Implementation Requirements

1725 HL7 v2.4 is fully backward compatible with HL7 v2.3. Refer to Section 2.4.2 when implementing HL7 v2.4.

### 2.4.4 HL7 v2.5 Message Implementation Requirements

#### 2.4.4.1 Acknowledgement Message

1730 The IHE Technical Framework provides for each HL7 message to be acknowledged by the HL7 ACK message sent by the receiver of an HL7 message to its sender. The segments of the ACK message listed below are required, and their detailed descriptions are provided in the following

subsections. The ERR segment is optional and may be included if the *MSA-1 Acknowledgment Code* field identifies an error condition.

**Table 2.4-5: Common ACK Message static definition**

Segment	Meaning	Usage	Card.	HL7 chapter
MSH	Message Header	R	[1..1]	2
MSA	Message Acknowledgement	R	[1..1]	2
ERR	Error	C	[0..*]	2

*Adapted from the HL7 Standard, version 2.5.1*

#### 1735 2.4.4.2 Message Control

The MSH (message header) segment contains control information set in the beginning of each message sent.

**Table 2.4-6: IHE Profile - MSH segment**

SEQ	LEN	DT	Usage	Card.	TBL#	ITEM#	Element name
1	1	SI	R	[1..1]		00001	Field Separator
2	4	ST	R	[1..1]		00002	Encoding Characters
3	227	HD	R	[1..1]		00003	Sending Application
4	227	HD	R	[1..1]		00004	Sending Facility
5	227	HD	R	[1..1]		00005	Receiving Application
6	227	HD	R	[1..1]		00006	Receiving Facility
7	26	TS	R	[1..1]		00007	Date/Time of Message
8	40	ST	X	[0..0]		00008	Security
9	15	MSG	R	[1..1]		00009	Message Type
10	20	ST	R	[1..1]		00010	Message Control Id
11	3	PT	R	[1..1]		00011	Processing Id
12	60	VID	R	[1..1]		00012	Version ID
13	15	NM	O	[0..1]		00013	Sequence Number
14	180	ST	X	[0..0]		00014	Continuation Pointer
15	2	ID	O	[0..0]	0155	00015	Accept Acknowledgement Type
16	2	ID	O	[0..0]	0155	00016	Application Acknowledgement Type
17	3	ID	RE	[1..1]	0399	00017	Country Code
18	16	ID	C	[0..1]	0211	00692	Character Set
19	250	CE	RE	[1..1]		00693	Principal Language of Message
20	20	ID	X	[0..0]	0356	01317	Alternate Character Set Handling Scheme
21	427	EI	RE	[0..*]		01598	Message Profile Identifier

*Adapted from the HL7 standard, version 2.5.1*

1740 **MSH-1 Field Separator**, required: IHE requires that applications support any ASCII value for field separator as specified in the HL7 standard. The value recommended by HL7 is “|” (ASCII 124).

1745 **MSH-2 Encoding Characters**, required: This field contains the four characters in the following order: the component separator, repetition separator, escape character, and subcomponent separator. IHE requires that applications support any ASCII values for encoding characters as specified in the HL7 standard. The values recommended by HL7 are “^~\&” (ASCII 94, 126, 92, and 38, respectively).

**MSH-9 Message Type (MSG)**, required:

Components: <Message Code (ID)> ^ <Trigger Event (ID)> ^ <Message Structure (ID)>

1750 Definition: This field contains the message type, trigger event, and the message structure ID for the message. All three components are required.

**MSH-10 Message Control Id (ST)**, required:

1755 Definition: This field contains a number or other identifier that uniquely identifies the message in the context of exchange between trading partners. Each message should be given a unique identifier by the sending system. The receiving system will echo this ID back to the sending system in the Message Acknowledgment segment (MSA). The combination of this identifier and the name of the sending application (MSH-3) should be unique across the message exchange environment.

**MSH-12 Version ID (VID)**, required:

1760 Components: <Version ID (ID)> ^ <Internationalization Code (CE)> ^ <International Version ID (CE)>

Definition: This field is matched by the receiving system to its supported version(s) to be sure the message will be interpreted correctly.

1765 The first component SHALL be populated with the value "2.5.1" or higher, representing HL7 Version 2.5.1 or higher. See Section 2.4.1.3.

**MSH-17 Country Code (ID)**, required if available.

Definition: This field contains the country of origin for the message. The values to be used are those of ISO 3166, using the 3-character alphabetic form. Refer to *HL7 Table 0399 - Country code*.

1770 Examples of valid values:

1775 JPN = Japan  
USA = United States  
GBR = United Kingdom  
ITA = Italy  
FRA = France  
NLD = Netherlands.

**MSH-18 Character Set (ID)**, conditional.

Definition: This field contains the character set for the entire message. Refer to *HL7 Table 0211 - Alternate character sets* for valid values.

1780 Examples of valid values:

ASCII: The printable 7-bit ASCII character set.

8859/1: The printable characters from the ISO 8859/1 Character set used by Western Europe. This character set can still be used, but 8859/15 should be used by preference. This character set is the forward-compatible version of 8859/1 and includes new characters such as the Euro currency symbol.

1785

ISO IR87: Code for the Japanese Graphic Character set for information interchange (JIS X 0208-1990).

UNICODE UTF-8: UCS Transformation Format, 8-bit form.

1790 **Condition predicate:** This field shall only be valued if the message uses a character set other than the 7-bit ASCII character set. Though the field is repeatable in HL7, IHE authorizes only one occurrence (i.e., one character set). The character set specified in this field is used for the encoding of all of the characters within the message.

**MSH-19 Principal Language of Message (CE)**, required if available. Coded from ISO 639.

1795 Examples:

DE = German

EN = English

ES = Spanish

JA = Japanese

1800

FR = French

NL = Dutch

IT = Italian

**MSH-20 Alternate Character Set Handling Scheme (ID)**, not supported: Character set switching is not allowed HL7 transactions of the IHE Technical Frameworks.

1805 **MSH-21 Message Profile Identifier (EI)**, required if available.

This field shall be valued in the messages for which a Message Profile has been officially registered with HL7. When multiple message profiles are listed in this field, they should be vendor specific and/or country specific message profiles constraining the official one.

### 2.4.4.3 Acknowledgement Modes

1810 This segment contains information sent while acknowledging another message.



**Table 2.4-7: MSA - Message Acknowledgement**

SEQ	LEN	DT	Usage	Card.	TBL#	ITEM#	Element name
1	2	ID	R	[1..1]	0008	00018	Acknowledgement code
2	20	ST	R	[1..1]		00010	Message Control Id
3	80	ST	X	[0..0]		00020	Text Message
4	15	NM	O	[0..1]		00021	Expected Sequence Number
5			X	[0..0]		00022	Delayed Acknowledgment Type
6	250	CE	X	[0..0]	0357	00023	Error Condition

*Adapted from the HL7 standard, version 2.5.1*

**MSA-1 Acknowledgment Code (ID), required.**

1815 This field shall contain the value AA, AE or AR when using Original Acknowledgement Mode, or CA, CE or CR when using Enhanced Acknowledgement Mode. See HL7 v2.5.1 Chapter 2 Section 2.9.2 and 2.9.3 for details.

**MSA-2 Message Control ID (ST), required.**

Definition: This field contains the message control ID from Field *MSH-10-Message Control ID* of the incoming message for which the acknowledgement is sent.

1820 **MSA-3 Text Message (ST), not supported.** See Section 2.4.4.4 for the ERR segment.

**MSA-6 Error Condition (CE), not supported.** See Section 2.4.4.4 for the ERR segment.

**2.4.4.4 ERR - Error segment**

This segment is used to add error comments to acknowledgment messages.

**Table 2.4-8: ERR – Error segment**

SEQ	LEN	DT	Usage	Card.	TBL#	ITEM#	Element name
1	493	ELD	X	[0..0]		00024	Error Code and Location
2	18	ERL	RE	[0..*]		01812	Error Location
3	705	CWE	R	[1..1]	0357	01813	HL7 Error Code
4	2	ID	R	[1..1]	0516	01814	Severity
5	705	CWE	O	[0..1]	0533	01815	Application Error Code
6	80	ST	O	[0..10]		01816	Application Error Parameter
7	2048	TX	O	[0..1]		01817	Diagnostic Information
8	250	TX	O	[0..1]		01818	User Message
9	20	IS	O	[0..*]	0517	01819	Inform Person Indicator
10	705	CWE	O	[0..1]	0518	01820	Override Type
11	705	CWE	O	[0..*]	0519	01821	Override Reason Code
12	652	XTN	O	[0..*]		01822	Help Desk Contact Point

1825

*Adapted from the HL7 standard, version 2.5.1*

**ERR-1** is deprecated since HL7 Version 2.5 (i.e., retained for backward compatibility only) and therefore not supported by IHE.

1830 **ERR-2** is populated except when the error is not within an HL7 field, component or subcomponent. For example, if the receiver returns an acknowledgement containing *MSA-1-acknowledgement code* value **AR** or **CR** to indicate that the receiving application was unavailable, ERR-2 is not populated

**ERR-3 HL7 Error Code (CWE)** is required. It identifies the HL7 (communication) error code. Valid values are given by HL7 Table 0357:

1835 In case that the receiving application does not recognize either the message type (MSH-9.1) or the trigger event (MSH-9.2) in a message, the components of Field ERR-2 of the acknowledgement shall be populated as follows.

	ERR-2.1:	<b>MSH</b>	
	ERR-2.2:	<b>1</b>	
	ERR-2.3:	<b>9</b>	
1840	ERR-2.4:	<b>1</b>	
	ERR-2.5:	<b>1</b>	if an unrecognized message type
		<b>2</b>	if an unrecognized trigger event

The components of Field ERR-3 of the acknowledgement shall be populated as follows.

	ERR-3.1:	<b>200</b>	if an unrecognized message type
1845		<b>201</b>	if an unrecognized trigger event
	ERR-3.2:	<b>Unsupported message type</b> or	
		<b>Unsupported trigger event</b> as appropriate	
	ERR-3.3:	<b>HL70357</b>	

1850 **ERR-4 Severity (ID)** is required. It identifies the severity of an application error. Valid values are given by HL7 Table 0516.

## 2.5 HL7 and DICOM Mapping Considerations

1855 Field lengths are explicitly defined in the DICOM standard, but an HL7 element might consist of multiple components that do not have a defined maximum length. It is recognized that there are some HL7 component lengths that could be longer than the DICOM attribute lengths. Data values for mapped fields are required not to exceed the smaller of either the HL7 or the DICOM field length definitions. Systems supporting alternative character sets must take into account the number of bytes per character in such sets. All systems are required to support the DICOM Default Character Set (ISO-IR 6 or ASCII). In addition, other character sets may be supported.

1860 Maintaining consistency of data encoded using alternative character sets is outside of the scope of the IHE Technical Framework.

Value Representations are not explicitly addressed. Attention shall be given to the mapping of the HL7 representation and the DICOM representation. Examples of these include Patient Name, dates and times.

## **2.6 Use of Coded Entities and Coding Schemes**

- 1865 Where applicable, coding schemes required by the DICOM, HL7, LOINC, and SNOMED standards are used in IHE Profiles. In the cases where such resources are not explicitly identified by standards, implementations may utilize any resource (including proprietary or local) provided any licensing/copyright requirements are satisfied.

1870 **3 Framework Overview**

The IHE Technical Framework is based on actors that interact through transactions.

Actors are information systems or components of information systems that produce, manage, or act on information associated with operational activities in the enterprise.

1875 Transactions are interactions between actors that transfer the required information through standards-based messages.

Specific sets of actors and transactions are specified in the Integration Profiles in the Radiology Technical Framework, Volume 1.

## 4 IHE Transactions

1880 This section defines each IHE transaction in detail, specifying the standards used, the information transferred, and the conditions under which the transaction is required or optional.

### 4.1 Patient Registration [RAD-1]

#### 4.1.1 Scope

1885 This transaction involves the patient information, including demographics, captured at the point of encounter. This may occur when the visit is scheduled, if that precedes patient arrival at the institution. This transaction is used for both in-patients (i.e., those who are assigned a bed at the facility) and outpatients (i.e., those who are not assigned a bed at the facility).

#### 4.1.2 Actor Roles

**Actor:** ADT

1890 **Role:** Adds and modifies patient demographic and encounter information.

**Actor:** Order Placer

**Role:** Receives patient and encounter information for use in order entry.

**Actor:** Department System Scheduler / Order Filler (DSS/OF)

1895 **Role:** Receives and stores patient and encounter information for use in fulfilling orders by the Department System Scheduler.

#### 4.1.3 Referenced Standards

HL7 v2.3.1 Chapters 2, 3

HL7 v2.5.1 Chapters 2, 3, 7, 15

IHE ITI Technical Framework

#### 1900 4.1.4 Messages

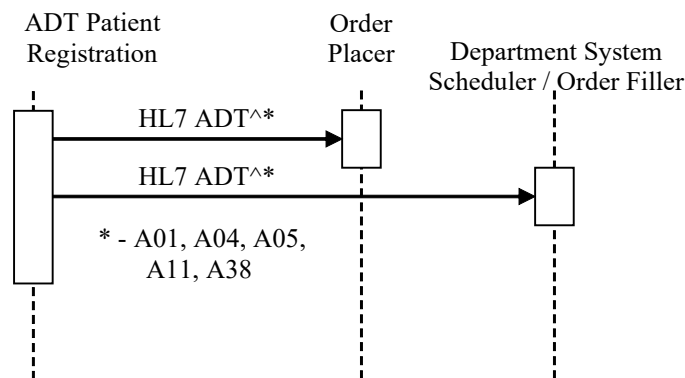


Figure 4.1.4-1: Interaction Diagram

#### 4.1.4.1 Patient Management – Admit/Register Patient

##### 4.1.4.1.1 Trigger Events

1905 The following events will trigger one of the Admit/Register messages:

- A01 – Admission of an in-patient into a facility
- A04 – Registration of an outpatient for a visit of the facility
- A05 – Pre-admission of an in-patient (i.e., registration of patient information ahead of actual admission).

##### 1910 4.1.4.1.2 Message Semantics

Message semantics are defined for both HL7 v2.3.1 and HL7 v2.5.1. The Profile and/or Options being claimed that incorporate this transaction will specify whether actors are required to support one, the other, or both sets of semantics.

##### 4.1.4.1.2.1 Message Semantics (HL7 v2.3.1)

1915 The Patient Registration transaction is conducted by the HL7 ADT message. The ADT Actor shall generate the message whenever a patient is admitted, pre-admitted or registered. In the event that a new patient will be seen as an outpatient at some future time, an ADT A04 message shall be used to convey patient information required by the Order Placer or Order Filler. Pre-admission of inpatients shall use the A05 message. The segments of the message listed below are required, and their detailed descriptions are provided in the following subsections.

1920

One or more AL1 segments shall be present if any allergies are identified for the patient at the time of registration. It may be absent otherwise.

One or more OBX segments shall be present if the information about patient weight and/or height is present. They may be absent otherwise.

1925 Note: Additional qualifications to the level of specification and HL7 profiling are stated in Section 2.3.

Required segments are defined below. Other segments are optional

ADT	Patient Administration Message	Chapter in HL7 2.3.1
MSH	Message Header	2
EVN	Event Type	3
PID	Patient Identification	3
PV1	Patient Visit	3
[{OBX}]	Observation/Result	7
[{AL1}]	Allergy Information	3

1930 Each message shall be acknowledged by the HL7 ACK message sent by the receiver of ADT message to its sender. See Section 2.4.3 “Acknowledgement Modes” for definition and discussion of the ACK message.

---

**4.1.4.1.2.1.1 MSH Segment (HL7 v2.3.1)**

MSH segment shall be constructed as defined in the Section 2.4.2.2 “Message Control”.

Field *MSH-9 Message Type* shall have at least two components. The first component shall have a value of “ADT”; the second component shall have values of A01, A04 or A05 as appropriate.

1935 The third component is optional; however, if present, it shall have a value of ADT\_01.

**4.1.4.1.2.1.2 EVN Segment (HL7 v2.3.1)**

Table 4.1-1 identifies required and optional fields of the EVN segment.

**Table 4.1-1: IHE Profile - EVN segment**

SEQ	LEN	DT	OPT	TBL#	ITEM#	ELEMENT NAME
1	3	ID	O	0003	00099	Event Type Code
2	26	TS	R		00100	Recorded Date/Time
3	26	TS	O		00101	Date/Time Planned Event
4	3	IS	O	0062	00102	Event Reason Code
5	60	XCN	O	0188	00103	Operator ID
6	26	TS	R2		01278	Event Occurred

*Adapted from the HL7 Standard, version 2.3.1*

1940 Field *EVN-1 Event Type Code* is optional; however, if present, its value shall be equal to the second component of the field *MSH-9 Message Type*.

**4.1.4.1.2.1.3 PID Segment (HL7 v2.3.1)**

Table 4.1-2 identifies required and optional fields of the PID segment.

**Table 4.1-2: IHE Profile - PID segment**

SEQ	LEN	DT	OPT	TBL#	ITEM#	ELEMENT NAME
1	4	SI	O		00104	Set ID - Patient ID
2	20	CX	O		00105	Patient ID
3	20	CX	R		00106	Patient Identifier List
4	20	CX	O		00107	Alternate Patient ID
5	48	XPN	R		00108	Patient Name
6	48	XPN	O		00109	Mother’s Maiden Name
7	26	TS	R2		00110	Date/Time of Birth
8	1	IS	R	0001	00111	Sex
9	48	XPN	O		00112	Patient Alias
10	80	CE	R2	0005	00113	Race
11	106	XAD	R2		00114	Patient Address
12	4	IS	O		00115	County Code
13	40	XTN	O		00116	Phone Number - Home

SEQ	LEN	DT	OPT	TBL#	ITEM#	ELEMENT NAME
14	40	XTN	O		00117	Phone Number - Business
15	60	CE	O	0296	00118	Primary Language
16	1	IS	O	0002	00119	Marital Status
17	80	CE	O	0006	00120	Religion
18	20	CX	C		00121	Patient Account Number
19	16	ST	O		00122	SSN Number – Patient
20	25	DLN	O		00123	Driver's License Number - Patient
21	20	CX	O		00124	Mother's Identifier
22	80	CE	O	0189	00125	Ethnic Group
23	60	ST	O		00126	Birth Place
24	1	ID	O	0136	00127	Multiple Birth Indicator
25	2	NM	O		00128	Birth Order
26	80	CE	O	0171	00129	Citizenship
27	60	CE	O	0172	00130	Veterans Military Status
28	80	CE	O		00739	Nationality
29	26	TS	O		00740	Patient Death Date and Time
30	1	ID	O	0136	00741	Patient Death Indicator

1945

*Adapted from the HL7 standard, version 2.3.1*

Additional requirements for the presence of a value in these PID fields may be documented in regional or national extensions to the IHE Technical Framework (see RAD TF-4).

1950

Field *PID-3 Patient Identifier List* - Patient IDs included in the PID-3 field shall include Assigning Authority (Component 4). The first subcomponent (namespace ID) of Assigning Authority shall be populated. If the second and third subcomponents (universal ID and universal ID type) are also populated, they shall reference the same entity as is referenced in the first subcomponent. See RAD TF-2x: Appendix B and Appendix D for further discussion of the use of PID-3 in transactions and its mapping from HL7 messages to DICOM Patient ID (0010,0020).

1955

At least one of the fields *PID-18 Patient Account Number* or *PV1-19 Visit Number* shall be valued.

#### 4.1.4.1.2.1.4 PV1 Segment (HL7 v2.3.1)

**Table 4.1-3: IHE Profile - PV1 Segment**

SEQ	LEN	DT	OPT	TBL#	ITEM#	ELEMENT NAME
1	4	SI	O		00131	Set ID - PV1
2	1	IS	R	0004	00132	Patient Class
3	80	PL	C		00133	Assigned Patient Location
4	2	IS	O	0007	00134	Admission Type
5	20	CX	O		00135	Preadmit Number
6	80	PL	O		00136	Prior Patient Location



IHE Radiology Technical Framework, Volume 2 (TF-2): Transactions

SEQ	LEN	DT	OPT	TBL#	ITEM#	ELEMENT NAME
7	60	XCN	C	0010	00137	Attending Doctor
8	60	XCN	C	0010	00138	Referring Doctor
9	60	XCN	R2	0010	00139	Consulting Doctor
10	3	IS	C	0069	00140	Hospital Service
11	80	PL	O		00141	Temporary Location
12	2	IS	O	0087	00142	Preadmit Test Indicator
13	2	IS	O	0092	00143	Readmission Indicator
14	3	IS	O	0023	00144	Admit Source
15	2	IS	C	0009	00145	Ambulatory Status
16	2	IS	O	0099	00146	VIP Indicator
17	60	XCN	C	0010	00147	Admitting Doctor
18	2	IS	O	0018	00148	Patient Type
19	20	CX	C		00149	Visit Number
20	50	FC	O	0064	00150	Financial Class
21	2	IS	O	0032	00151	Charge Price Indicator
22	2	IS	O	0045	00152	Courtesy Code
23	2	IS	O	0046	00153	Credit Rating
24	2	IS	O	0044	00154	Contract Code
25	8	DT	O		00155	Contract Effective Date
26	12	NM	O		00156	Contract Amount
27	3	NM	O		00157	Contract Period
28	2	IS	O	0073	00158	Interest Code
29	1	IS	O	0110	00159	Transfer to Bad Debt Code
30	8	DT	O		00160	Transfer to Bad Debt Date
31	10	IS	O	0021	00161	Bad Debt Agency Code
32	12	NM	O		00162	Bad Debt Transfer Amount
33	12	NM	O		00163	Bad Debt Recovery Amount
34	1	IS	O	0111	00164	Delete Account Indicator
35	8	DT	O		00165	Delete Account Date
36	3	IS	O	0112	00166	Discharge Disposition
37	25	CM	O	0113	00167	Discharged to Location
38	80	CE	O	0114	00168	Diet Type
39	2	IS	O	0115	00169	Servicing Facility
40	1	IS	O	0116	00170	Bed Status
41	2	IS	O	0117	00171	Account Status
42	80	PL	O		00172	Pending Location
43	80	PL	O		00173	Prior Temporary Location
44	26	TS	O		00174	Admit Date/Time
45	26	TS	O		00175	Discharge Date/Time
46	12	NM	O		00176	Current Patient Balance

SEQ	LEN	DT	OPT	TBL#	ITEM#	ELEMENT NAME
47	12	NM	O		00177	Total Charges
48	12	NM	O		00178	Total Adjustments
49	12	NM	O		00179	Total Payments
50	20	CX	O	0203	00180	Alternate Visit ID
51	1	IS	C	0326	01226	Visit Indicator
52	60	XCN	O	0010	01224	Other Healthcare Provider

*Adapted from the HL7 standard, version 2.3.1*

1960 Additional requirements for the presence of value in these fields may be documented in regional or national extensions to the IHE Technical Framework (see RAD TF-4).

Fields *PVI-3 Assigned Patient Location*, *PVI-7 Attending Doctor*, *PVI-10 Hospital Service*, *PVI-17 Admitting Doctor* shall be valued only when admitting in-patient, i.e., when the *MSH-9 Message Type* is ADT^A01.

1965 Field *PVI-8 Referring Doctor* shall be valued when registering an outpatient (*MSH-9 Message Type* is ADT^A04) or when pre-registering a patient (*MSH-9 Message Type* is ADT^A05).

Field *PVI-15 Ambulatory Status* shall be valued when patient status indicates certain conditions such as pregnancy. May be omitted if none of the defined statuses are applicable to a patient.

At least one of the fields *PID-18 Patient Account Number* or *PVI-19 Visit Number* shall be valued.

1970 Field *PVI-51 Visit Indicator* shall be valued with value “V” if the field *PVI-19 Visit Number* is present. May be omitted otherwise.

#### 4.1.4.1.2.1.5 AL1 Segment (HL7 v2.3.1)

**Table 4.1-4: IHE Profile – AL1 segment**

SEQ	LEN	DT	OPT	TBL#	ITEM#	ELEMENT NAME
1	4	SI	R		00203	Set ID - AL1
2	2	IS	O	0127	00204	Allergy Type
3	60	CE	R		00205	Allergy Code/Mnemonic/Description
4	2	IS	O	0128	00206	Allergy Severity
5	15	ST	O		00207	Allergy Reaction
6	8	DT	O		00208	Identification Date

*Adapted from the HL7 standard, version 2.3.1*

#### 1975 4.1.4.1.2.1.6 OBX Segment (HL7 v2.3.1)

The IHE Technical Framework includes the OBX segment primarily for the purposes of communicating patient height and weight. In this context, the optionality of fields *OBX-3 Observation Identifier* has been changed to “R2” and *OBX-4 Observation Result Status* has been

1980 changed to “O”. Please refer to RAD TF-2x: Appendix B for additional details on Patient Height and Weight mapping.

Field *OBX-6 Units* is optional. When the OBX segments are sent to transmit the height and weight, this field shall be valued.

**Table 4.1-5: IHE Profile - OBX Segment**

SEQ	LEN	DT	OPT	TBL#	ITEM#	ELEMENT NAME
1	4	SI	O		00569	Set ID - OBX
2	3	ID	C	0125	00570	Value Type
3	80	CE	R		00571	Observation Identifier
4	20	ST	C		00572	Observation Sub-ID
5	65536	*	C		00573	Observation Value
6	60	CE	O		00574	Units
7	60	ST	O		00575	References Range
8	5	ID	O	0078	00576	Abnormal Flags
9	5	NM	O		00577	Probability
10	2	ID	O	0080	00578	Nature of Abnormal Test
11	1	ID	R	0085	00579	Observe Result Status
12	26	TS	O		00580	Date Last Obs Normal Values
13	20	ST	O		00581	User Defined Access Checks
14	26	TS	O		00582	Date/Time of the Observation
15	60	CE	O		00583	Producer's ID
16	80	XCN	O		00584	Responsible Observer
17	60	CE	O		00936	Observation Method

*Adapted from the HL7 Standard, version 2.3.1*

1985 **4.1.4.1.2.2 Message Semantics (HL7 v2.5.1)**

Actors shall implement the message semantics of [Patient Encounter Management \[ITI-31\]](#) for each trigger event specified in Section 4.1.4.1.1.

The Patient Management-Admit/Register Patient messages are defined in the ITI Technical Framework as follows:

- 1990
- ADT^A01 Admit Patient in [ITI TF-2: 3.31.7.1](#) Admit/Visit Notification (ADT^A01^ADT\_A01)
  - ADT^A04 Register Patient in [ITI TF-2: 3.31.7.3](#) Register a Patient (ADT^A04^ADT\_A01)
  - ADT^A05 Pre-Admit Patient in [ITI TF-2: 3.31.7.7](#) Pre-Admit (ADT^A05^ADT\_A05)

1995 Required and conditional segments are defined below. Other segments are optional.

Segment	Meaning	Usage	Card.	HL7 chapter
MSH	Message Header	R	[1..1]	2
EVN	Event Type	R	[1..1]	3
PID	Patient Identification	R	[1..1]	3
PV1	Patient Visit	R	[1..1]	3
ROL	Role	R2	[0..*]	15
OBX	Observation/Result	C	[0..*]	7
AL1	Allergy Information	C	[0..*]	3

The allergy segment AL1 shall be present if allergy information is added/updated. OBX segment(s) shall be present if patient weight and/or height is updated.

**4.1.4.1.2.2.1 MSH Segment (HL7 v2.5.1)**

2000 The MSH segment shall be constructed as defined in [ITI TF-2: 3.30.5.1](#) MSH – Header Segment. Additional specifications for actors complying with the IHE Radiology Technical Framework are defined in Section 2.4.

2005 Field *MSH-9-Message Type* shall have three components. The first component shall have a value of ADT; the second component shall have values of A01, A04 or A05 as appropriate. The third component shall have a value of ADT\_A01 for the A01 and A04 trigger events, or ADT\_A05 for the A05 trigger event.

**4.1.4.1.2.2.2 EVN Segment (HL7 v2.5.1)**

The EVN segment shall be constructed as defined in [ITI TF-2: 3.30.5.2](#) EVN – Event Type Segment.

2010 **4.1.4.1.2.2.3 PID Segment (HL7 v2.5.1)**

The PID Segment shall be constructed as defined in [ITI TF-2: 3.30.5.3](#) PID – Patient Identification Segment. Additional required and conditionally required fields are specified in Table 4.1-6.

**Table 4.1-6: IHE Profile - PID Segment**

SEQ	LEN	DT	OPT	TBL#	ITEM#	ELEMENT NAME
7	26	TS	R2		00110	Date/Time of Birth
8	1	IS	R	0001	00111	Administrative Sex
10	250	CE	R2	0005	00113	Race
11	250	XAD	R2		00114	Patient Address
18	250	CX	C		00121	Patient Account Number

2015 *Adapted from the HL7 standard, version 2.5.1*

Additional requirements for the presence of value in these fields may be documented in regional or national extensions to the IHE Technical Framework (see RAD TF-4).

2020 Field *PID-3 Patient Identifier List* - Patient IDs in the PID-3 field shall include Assigning Authority (Component 4) and Identifier Type Code (Component 5). The first subcomponent (namespace ID) of Assigning Authority shall be populated. If the second and third subcomponents (universal ID and universal ID type) are also populated, they shall reference the same entity as is referenced in the first subcomponent. [ITI TF-2: 3.30.5.3](#) “PID – Patient Identification Segment” provides additional details for implementing the PID-3 components. See RAD TF-2x: Appendix D for further discussion of the use of PID-3 in transactions and its mapping from HL7 messages to DICOM Patient ID (0010, 0020).

2025

At least one of the fields *PID-18 Patient Account Number* or *PV1-19 Visit Number* shall be valued. At least one of the fields *PID-18 Patient Account Number* or *PV1-19 Visit Number* shall be valued.

**4.1.4.1.2.2.4 PV1 Segment (HL7 v2.5.1)**

2030 The PV1 Segment shall be constructed as defined in [ITI TF-2: 3.30.5.4](#) PV1 - Patient Visit Segment.

Additional optional, prohibited and conditionally required fields are specified in Table 4.1-7

**Table 4.1-7: IHE Profile - PV1 Segment**

SEQ	LEN	DT	OPT	TBL#	ITEM#	ELEMENT NAME
6	80	PL	O		00136	Prior Patient Location
7	250	XCN	C	0010	00137	Attending Doctor
8	250	XCN	C	0010	00138	Referring Doctor
9	250	XCN	X	0010	00139	Consulting Doctor
10	3	IS	C	0069	00140	Hospital Service
11	80	PL	O		00141	Temporary Location
15	2	IS	C	0009	00145	Ambulatory Status
17	250	XCN	C	0010	00147	Admitting Doctor
19	20	CX	C		00149	Visit Number
51	1	IS	C	0326	01226	Visit Indicator

*Adapted from the HL7 standard, version 2.5.1*

2035 Additional requirements for the presence of value in these fields may be documented in regional or national extensions to the IHE Technical Framework (see RAD TF-4).

Fields *PV1-3-Assigned Patient Location*, *PV1-7-Attending Doctor*, *PV1-10-Hospital Service*, *PV1-17-Admitting Doctor* shall be valued only when admitting an inpatient, i.e., when the value of *MSH-9-Message Type* is ADT^A01^ADT\_A01.

2040 Field *PV1-8-Referring Doctor* shall be valued when registering an outpatient (*MSH-9- Message Type* is ADT^A04^ADT\_A01) or when pre-registering a patient (*MSH-9-Message Type* is ADT^A05^ADT\_A05).

The PV1 segment shall be followed for each of the attending doctor, admitting doctor, and referring doctor, by a ROL segment.

2045 Field *PV1-9-Consulting Doctor* shall not be present. The consulting doctor(s) are required and entirely described in the ROL segments.

Field *PV1-15-Ambulatory Status* shall be valued when patient status indicates pregnancy (patient is pregnant). It may be omitted otherwise.

2050 At least one of the *fields PID-18-Patient Account Number or PV1-19-Visit Number* shall be valued.

Field *PV1-51-Visit Indicator* shall be valued with value “V” if the field *PV1-19-Visit Number* is valued. It may be omitted otherwise.

**4.1.4.1.2.5 ROL Segment (HL7 v2.5.1)**

2055 One ROL segment shall be included for each attending doctor, admitting doctor, referring doctor and consulting doctor, if any. Note that some Provider Role codes in the ROL Segment use the word "Provider" rather than "Doctor".

The ROL Segment shall be constructed as defined in [ITI TF-2: 3.30.5.6](#) ROL- Role Segment.

**4.1.4.1.2.6 OBX Segment (HL7 v2.5.1)**

2060 The OBX Segment shall be constructed as defined in [ITI TF-2: 3.30.5.7](#) OBX – Observation/Result Segment.

Additional optional, required and conditionally required fields are specified in Table 4.1-8.

**Table 4.1-8: IHE Profile - OBX Segment**

SEQ	LEN	DT	OPT	TBL#	ITEM #	ELEMENT NAME
2	2	ID	C	0125	00570	Value Type
3	250	CE	R2		00571	Observation Identifier
4	20	ST	C		00572	Observation Sub-ID
5	99999	varies	C		00573	Observation Value
6	250	CE	C		00574	Units
11	1	ID	R	0085	00579	Observe Result Status

*Adapted from the HL7 Standard, version 2.5.1*

Refer to RAD TF-2x: Appendix B for additional details on Patient Height and Weight mapping.

2065 Field *OBX-6-Units* is required if the OBX segments are sent to transmit the height and weight.

**4.1.4.1.2.7 AL1 Segment (HL7 v2.5.1)**

The AL1 Segment shall be constructed as defined in [ITI TF-2: 3.30.5.8](#) AL1 - Patient Allergy Information Segment.

#### 4.1.4.1.3 Expected Actions

2070 The receiver of the ADT Patient Registration transaction message shall create a new patient record for the patient identified if there is no current record for the Patient ID (defined by the field *PID-3*). Interpretation of A01, A04 and A05 messages after the patient record was created is beyond the scope of the IHE Technical Framework; however, the ADT Patient Registration [RAD-1] transaction shall not be used to update information in an existing patient record. The Patient Update [RAD-12] transaction shall be used instead.

2075 The interpretation of A01, A04 and A05 messages after the patient record was created is described in the ITI Technical Framework in the following sections:

- [ITI TF-2: 3.31.7.1.4](#) Expected Actions for Admit/Visit Notification
- [ITI TF-2: 3.31.7.3.4](#) Expected Actions for Register a Patient
- [ITI TF-2: 3.31.7.7.4](#) Expected Actions for Pre-Admit

2080

#### 4.1.4.2 Patient Management – Cancel Admit/Register Patient

##### 4.1.4.2.1 Trigger Events

The following events will trigger one of the Admit/Register messages:

- A11 – Admission of an in-patient into a facility or registration of an outpatient for a visit of the facility has been cancelled due to error in the information or the decision not to admit/register patient after all.
- A38 – Pre-admission of an in-patient (i.e., registration of patient information ahead of actual admission) has been cancelled due to error in the information or the decision not to admit/register patient after all.

2085

##### 4.1.4.2.2 Message Semantics

2090 Message semantics are defined for both HL7 v2.3.1 and HL7 v2.5.1. The Profile and/or Options being claimed that incorporate this transaction will specify whether actors are required to support one, the other, or both sets of semantics.

##### 4.1.4.2.2.1 Message Semantics (HL7 v2.3.1)

2095 Patient Registration conveyed by the HL7 ADT^A01, ADT^A04 or ADT^A05 may have to be revoked due to the errors in the information or the decision of not admitting/registering patient. The cancellation transaction is conveyed by the HL7 ADT^A11 or ADT^A38 messages. ADT^A11 shall be used to revoke the transaction conveyed by the ADT^A01 or ADT^A04 message. ADT^A38 shall be used to revoke transaction conveyed by the ADT^A05 message.

2100 Cancellation messages shall be used only if no other transactions were performed by the ADT on the patient record after the admit/registration transaction was conveyed.

The segments of the message listed below are required, and their detailed descriptions are provided in subsections below. All other segments are optional.

2105 **Note:** Additional qualifications to the level of specification and HL7 profiling are stated in Section 2.3.

ADT	Patient Administration Message	Chapter in HL7 2.3.1
MSH	Message Header	2
EVN	Event Type	3
PID	Patient Identification	3
PV1	Patient Visit	3

Each message shall be acknowledged by the HL7 ACK message sent by the receiver of ADT message to its sender. See Section 2.4.3 “Acknowledgement Modes” for definition and discussion of the ACK message.

2110 **4.1.4.2.2.1.1 MSH Segment (HL7 v2.3.1)**

MSH segment shall be constructed as defined in the Section 2.4.2.2 “Message Control”.

2115 Field *MSH-9 Message Type* shall have at least two components. The first component shall have a value of “ADT”; the second component shall have values of A11 or A38 as appropriate. The third component is optional; however, if present, it shall have a value of ADT\_A09 (for the A11 message) or ADT\_A38 (for A38 message).

**4.1.4.2.2.1.2 EVN Segment (HL7 v2.3.1)**

See Section 4.1.4.1.2.1.2 for required and optional fields of the EVN segment.

**4.1.4.2.2.1.3 PID Segment (HL7 v2.3.1)**

2120 All of the fields in PID segment are optional, except those listed in Table 4.1-9. See Section 4.1.4.1.2.1.3 for the list of all fields of the PID segment.

**Table 4.1-9: IHE Profile - PID segment**

SEQ	LEN	DT	OPT	TBL#	ITEM#	ELEMENT NAME
3	20	CX	R		00106	Patient Identifier List
5	48	XPN	R		00108	Patient Name
18	20	CX	C		00121	Patient Account Number

*Adapted from the HL7 standard, version 2.3.1*

**4.1.4.2.2.1.4 PV1 Segment (HL7 v2.3.1)**

2125 All of the fields in PV1 segment are optional, except those listed in Table 4.1-10. See Section 4.1.4.1.2.1.4 for the list of all fields of the PV1 segment.



**Table 4.1-10: IHE Profile - PV1 Segment**

SEQ	LEN	DT	OPT	TBL#	ITEM#	ELEMENT NAME
2	1	IS	R	0004	00132	Patient Class
19	20	CX	C		00149	Visit Number
51	1	IS	C	0326	01226	Visit Indicator

*Adapted from the HL7 standard, version 2.3.1*

2130 At least one of the fields *PID-18 Patient Account Number* or *PV1-19 Visit Number* shall be valued. Additional requirements for the presence of value in these fields may be documented in regional or national extensions to the IHE Radiology Technical Framework (see RAD TF-4). It is required if it has been present in the registration message A01, A04 or A05 that is being cancelled by this transaction.

Field *PV1-51 Visit Indicator* shall be valued with value “V” if the field *PV1-19 Visit Number* is present. May be omitted otherwise.

#### 2135 4.1.4.2.2.2 Message Semantics (HL7 v2.5.1)

The Patient Management-Cancel Admit/Register Patient [RAD-1] transaction is implemented by the [Patient Encounter Management \[ITI-31\]](#) transaction triggers events and related messages:

- ADT^A11 Cancel Admit Patient
- ADT^A38 Cancel Pre-Admit Patient

2140 The above messages are described in the following sections:

- [ITI TF-2: 3.31.7.2](#) Cancel Admit/Visit Notification (ADT^A11^ADT\_A09)
- [ITI TF-2: 3.31.7.8](#) Cancel Pre-Admit (ADT^A38^ADT\_A38)

#### 4.1.4.2.2.2.1 MSH Segment (HL7 v2.5.1)

2145 The MSH segment shall be constructed as defined in [ITI TF-2: 3.30.5.1](#) MSH – Header Segment. Additional specifications for actors complying with the IHE Radiology Technical Framework are defined in Section 2.4.

2150 Field *MSH-9-Message Type* shall have three components. The first component shall have a value of ADT; the second component shall have values of A11 or A38 as appropriate. The third component shall have a value of ADT\_A09 (for the A11 message) or ADT\_A38 (for the A38 message).

#### 4.1.4.2.2.2.2 EVN Segment (HL7 v2.5.1)

The EVN segment shall be constructed as defined in [ITI TF-2: 3.30.5.2](#) EVN – Event Type Segment.

**4.1.4.2.2.3 PID Segment (HL7 v2.5.1)**

2155 All of the fields in the PID segment are optional, except those listed in Table 4.1-11. See Section 4.1.4.1.2.2.3 for a full discussion of the PID segment.

**Table 4.1-11: IHE Profile - PID Segment**

SEQ	LEN	DT	OPT	TBL#	ITEM#	ELEMENT NAME
3	250	CX	R		00106	Patient Identifier List
5	250	XPN	R		00108	Patient Name
18	250	CX	C		00121	Patient Account Number

*Adapted from the HL7 standard, version 2.5.1*

**4.1.4.2.2.4 PV1 Segment (HL7 v2.5.1)**

2160 All of the fields in the PV1 segment are optional, except those listed in Table 4.1-12. See Section 4.1.4.1.2.2.4 for a full discussion of the PV1 segment.

**Table 4.1-12: IHE Profile - PV1 Segment**

SEQ	LEN	DT	OPT	TBL#	ITEM#	ELEMENT NAME
2	1	IS	R	0004	00132	Patient Class
19	250	CX	C		00149	Visit Number
51	1	IS	C	0326	01226	Visit Indicator

*Adapted from the HL7 standard, version 2.5.1*

2165 Additional requirements for the presence of value in these fields may be documented in regional or national extensions to the IHE Technical Framework (see RAD TF-4).

At least one of the fields *PID-18-Patient Account Number* or *PV1-19-Visit Number* shall be valued. It is required if it has been present in the registration message A01, A04 or A05 that is being cancelled by this transaction.

2170 Field *PV1-51-Visit Indicator* shall be valued with value “V” if the field *PV1-19-Visit Number* is valued. It may be omitted otherwise.

**4.1.4.2.3 Expected Actions**

2175 If the patient record was created as a result of a Patient Registration transaction, such record shall be discarded. If the Patient Registration transaction was sent for an existing patient record, the corresponding operations shall be “rewound” to restore the record condition existing before Patient Transaction was sent.

## 4.2 Placer Order Management [RAD-2]

### 4.2.1 Scope

2180 This transaction is used by the Order Placer to place a new order with the Order Filler. It also allows the Order Placer to cancel the order. For the Order Placer asserting compliance with HL7 Version 2.5.1, this transaction is used to change an order with the Order. For the Order Placer asserting compliance to HL7 Version 2.3.1, to change order information, the Order Placer would cancel the initial order and place the new one. The Order Placer and Department System Scheduler/Order Filler must agree on the support of recurring orders and panel orders, if used.

*Recurring order:* An order with a performance frequency greater than one. For example, portable chest x-ray at 6:00 AM for the next seven days.

2190 *Panel order:* A service item with more than one observation component. For example, a nuclear cardiac study that has a cardiology component and a radiology component that are usually reported on separately.

For an illustration of mapping between transactions [RAD-2], [RAD-3], [RAD-5], [RAD-6] and [RAD-7], see the IHE white paper “Code Mapping in IHE Radiology Profiles”, [https://www.ihe.net/uploadedFiles/Documents/Radiology/IHE\\_RAD\\_White-Paper\\_Codes.pdf](https://www.ihe.net/uploadedFiles/Documents/Radiology/IHE_RAD_White-Paper_Codes.pdf).

### 4.2.2 Actor Roles

2195 **Actor:** Order Placer

**Role:** Places orders. Cancels orders as necessary.

**Actor:** Department System Scheduler/Order Filler

**Role:** Receives and processes (fills) orders. Receives order cancellations.

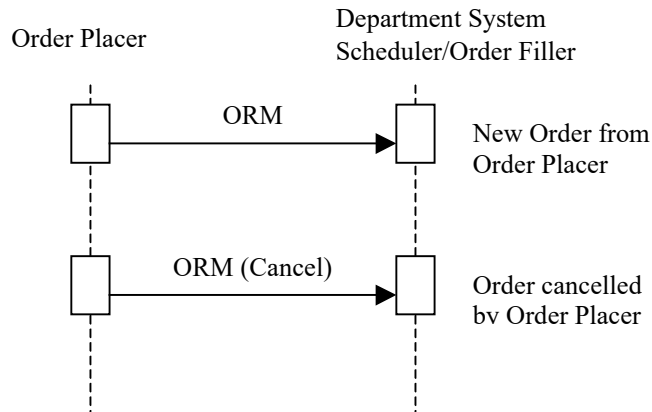
### 4.2.3 Referenced Standards

2200 HL7 v2.3.1 Chapter 4

HL7 v2.5.1 Chapter 4

### 4.2.4 Messages

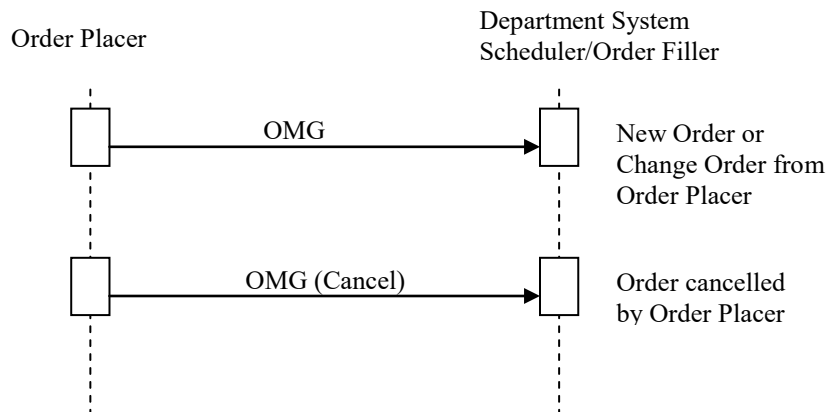
The following diagram illustrates interactions between actors within systems implementing HL7 v2.3.1:



2205

**Figure 4.2.4-1: Interactions between actors within systems implementing HL7 v2.3.1**

The following diagram illustrates interactions between actors within systems implementing HL7 v2.5.1:



2210

**Figure 4.2.4-2: Interactions between actors within systems implementing HL7 v2.5.1**

#### 4.2.4.1 Order Management – New Order from Order Placer

##### 4.2.4.1.1 Trigger Events

The following event will trigger the ORM messages within systems implementing HL7 v2.3.1:

2215 ORM – The Order Placer places a new order for the Department System Scheduler/Order Filler.

The following event will trigger the OMG messages within systems implementing HL7 v2.5.1:

OMG – The Order Placer places a new order for the Department System Scheduler/Order Filler.

**4.2.4.1.2 Message Semantics**

2220 Message semantics are defined for both HL7 v2.3.1 and HL7 v2.5.1. The Profile and/or Options being claimed that incorporate this transaction will specify whether actors are required to support one, the other, or both sets of semantics.

**4.2.4.1.2.1 Message Semantics (HL7 v2.3.1)**

HL7 2.3.1 Chapter 4 ORM message. Refer to HL7 Standard for general message semantics.

2225 The order start date/time or exam date/time is required in the “Quantity/Timing” field of both the ORC and OBR segments (ORC-7.4; OBR-27.4).

**Note:** Additional qualifications to the level of specification and HL7 profiling are stated in Section 2.3.

Required segments are listed below. Other segments are optional.

2230

ORM	General Order Message	Chapter in HL7 2.3.1
MSH	Message Header	2
PID	Patient Identification	3
PV1	Patient Visit	3
ORC	Common Order	4
OBR	Order Detail	4

Each message shall be acknowledged by the HL7 ACK message sent by the receiver of ADT message to its sender. See Section 2.4.3 “Acknowledgement Modes” for definition and discussion of the ACK message.

**4.2.4.1.2.1.1 MSH Segment (HL7 v2.3.1)**

2235 MSH segment shall be constructed as defined in the Section 2.4.2.2 “Message Control”.

Field *MSH-9 Message Type* shall have at least two components. The first component shall have a value of “ORM”; the second component shall have value of O01. The third component is optional; however, if present, it shall have a value of ORM\_O01.

**4.2.4.1.2.1.2 PID Segment (HL7 v2.3.1)**

2240 All of the fields in PID segment are optional, except those listed in Table 4.2-1. See Section 4.1.4.1.2.1.3 for the list of all fields of the PID segment.

**Table 4.2-1: IHE Profile - PID segment**

SEQ	LEN	DT	OPT	TBL#	ITEM#	ELEMENT NAME
3	20	CX	R		00106	Patient Identifier List
5	48	XP	R		00108	Patient Name
18	20	CX	C		00121	Patient Account Number

2245

*Adapted from the HL7 standard, version 2.3.1***4.2.4.1.2.1.3 PV1 Segment (HL7 v2.3.1)**

All of the fields in PV1 segment are optional, except those listed in Table 4.2-2. See Section 4.1.4.1.2.1.4 for the list of all fields of the PV1 segment.

**Table 4.2-2: IHE Profile - PV1 Segment**

SEQ	LEN	DT	OPT	TBL#	ITEM#	ELEMENT NAME
2	1	IS	R	0004	00132	Patient Class
8	60	XCN	R2	0010	00138	Referring Doctor
19	20	CX	C		00149	Visit Number
51	1	IS	C	0326	01226	Visit Indicator

2250

*Adapted from the HL7 standard, version 2.3.1*

At least one of the fields *PID-18 Patient Account Number* or *PV1-19 Visit Number* shall be valued. Additional requirements for the presence of value in these fields may be documented in regional or national extensions to the IHE Radiology Technical Framework (see RAD TF-4).

Field *PV1-51 Visit Indicator* shall be valued with value “V” if the field *PV1-19 Visit Number* is present. May be omitted otherwise.

2255

**4.2.4.1.2.1.4 ORC Segment (HL7 v2.3.1)**

ORC segment conveys common order information.

**Table 4.2-3: IHE Profile - ORC Segment**

SEQ	LEN	DT	OPT	TBL#	ITEM #	ELEMENT NAME
1	2	ID	R	0119	00215	Order Control
2	22	EI	R		00216	Placer Order Number
3	22	EI	O		00217	Filler Order Number
4	22	EI	C		00218	Placer Group Number
5	2	ID	O	0038	00219	Order Status
6	1	ID	O	0121	00220	Response Flag
7	200	TQ	R		00221	Quantity/Timing
8	200	CM	C		00222	Parent
9	26	TS	R		00223	Date/Time of Transaction

SEQ	LEN	DT	OPT	TBL#	ITEM #	ELEMENT NAME
10	120	XCN	R2		00224	Entered By
11	120	XCN	O		00225	Verified By
12	120	XCN	R		00226	Ordering Provider
13	80	PL	O		00227	Enterer's Location
14	40	XTN	R2		00228	Call Back Phone Number
15	26	TS	O		00229	Order Effective Date/Time
16	200	CE	O		00230	Order Control Code Reason
17	60	CE	R		00231	Entering Organization
18	60	CE	O		00232	Entering Device
19	120	XCN	O		00233	Action By

*Adapted from the HL7 Standard, version 2.3.1*

2260 Field *ORC-3 Filler Order Number* shall not be present.

Field *ORC-4 Placer Group Number* shall be valued only if the Order Placer and Order Filler utilize concept of Order Groups. Shall not be present otherwise.

Field *ORC-8 Parent* shall be valued only if the current order is a child order (i.e., if the field *ORC-1 Order Control* has a value of CH).

2265 The action to be performed in the ORM message is defined by the Order Control code passed as part of the message. HL7 defines a number of Order Control codes.

The order control codes below shall be supported.

#### Supported Order Control Codes

Value	Description
NW <sup>R</sup>	New order
PA <sup>O</sup>	Parent order
CH <sup>O</sup>	Child order

*Adapted from the HL7 Standard, version 2.3.1*

2270 <sup>R</sup>=Required; <sup>O</sup>=Optional

**Note:** The use of Required/Optional superscripts in the Value column is an IHE extension and is not part of the HL7 Standard.

#### 4.2.4.1.2.1.5 OBR Segment (HL7 v2.3.1)

**Table 4.2-4: IHE Profile - OBR Segment**

SEQ	LEN	DT	OPT	TBL#	ITEM #	ELEMENT NAME
1	4	SI	O		00237	Set ID - OBR

IHE Radiology Technical Framework, Volume 2 (TF-2): Transactions

SEQ	LEN	DT	OPT	TBL#	ITEM #	ELEMENT NAME
2	75	EI	R		00216	Placer Order Number
3	75	EI	O		00217	Filler Order Number
4	200	CE	R		00238	Universal Service ID
5	2	ID	O		00239	Priority
6	26	TS	O		00240	Requested Date/time
7	26	TS	O		00241	Observation Date/Time
8	26	TS	O		00242	Observation End Date/Time
9	20	CQ	O		00243	Collection Volume
10	60	XCN	O		00244	Collector Identifier
11	1	ID	O	0065	00245	Specimen Action Code
12	60	CE	R2		00246	Danger Code
13	300	ST	C		00247	Relevant Clinical Info.
14	26	TS	O		00248	Specimen Received Date/Time
15	300	CM	C	0070	00249	Specimen Source
16	80	XCN	R		00226	Ordering Provider
17	40	XTN	O		00250	Order Callback Phone Number
18	60	ST	O		00251	Placer field 1
19	60	ST	O		00252	Placer field 2
20	60	ST	O		00253	Filler Field 1
21	60	ST	O		00254	Filler Field 2
22	26	TS	O		00255	Results Rpt/Status Chng - Date/Time
23	40	CM	O		00256	Charge to Practice
24	10	ID	O	0074	00257	Diagnostic Serv Sect ID
25	1	ID	O	0123	00258	Result Status
26	400	CM	O		00259	Parent Result
27	200	TQ	R		00221	Quantity/Timing
28	150	XCN	O		00260	Result Copies To
29	150	CM	C		00261	Parent
30	20	ID	R2	0124	00262	Transportation Mode
31	300	CE	R2		00263	Reason for Study
32	200	CM	O		00264	Principal Result Interpreter
33	200	CM	O		00265	Assistant Result Interpreter
34	200	CM	O		00266	Technician
35	200	CM	O		00267	Transcriptionist
36	26	TS	O		00268	Scheduled Date/Time
37	4	NM	O		01028	Number of Sample Containers
38	60	CE	O		01029	Transport Logistics of Collected Sample



SEQ	LEN	DT	OPT	TBL#	ITEM #	ELEMENT NAME
39	200	CE	O		01030	Collector's Comment
40	60	CE	O		01031	Transport Arrangement Responsibility
41	30	ID	R2	0224	01032	Transport Arranged
42	1	ID	O	0225	01033	Escort Required
43	200	CE	O		01034	Planned Patient Transport Comment
44	80	CE	O	0088	00393	Procedure Code
45	80	CE	O	0340	01036	Procedure Code Modifier

2275

*Adapted from the HL7 Standard, version 2.3.1*

Field *OBR-13 Relevant Clinical Info* shall be populated if patient record contains any medical alerts that may be relevant to the order and, in particular, need to be communicated to the technologist.

2280

Field *OBR-15 Specimen Source* holds the laterality (Left/Right) indicator (when used) in the <site modifier (CE)> component. See RAD TF-2x: Appendix B for details.

Per the HL7 Standard, IHE recommends that the fields in ORC and OBR segments given in the following table contain the same information.

**Identical Element Mappings between ORC and OBR Segments**

Element Name	ORC Segment Element	OBR Segment Element
Placer Order Number	ORC-2	OBR-2
Filler Order Number	ORC-3	OBR-3
Quantity/Timing	ORC-7	OBR-27
Parent	ORC-8	OBR-29

**4.2.4.1.2.2 Message Semantics (HL7 v2.5.1)**

2285

The HL7 v2.5.1 Message Semantics implements the Chapter 4 OMG message. Refer to the HL7 Standard for general message semantics.

Note: Additional qualifications to the level of specification and HL7 profiling are stated in Section 2.3.

Required and conditional segments are listed below. Other segments are optional.

2290

Segment	Meaning	Usage	Card.	HL7 chapter
MSH	Message Header	R	[1..1]	2
PID	Patient Identification	R	[1..1]	3
PV1	Patient Visit	R	[1..1]	3
AL1	Allergy Information	C	[0..*]	3

Segment	Meaning	Usage	Card.	HL7 chapter
ORC	Common Order	R	[1..*]	4
TQ1	Timing/Quantity	R	[1..1]	4
OBR	Order Detail	R	[1..1]	4
OBX	Observation/Result	C	[0..*]	7

The allergy segment AL1 shall be present if allergy information is added/updated. The OBX segment(s) shall be present if patient weight and/or height is updated.

Each message shall be acknowledged by the HL7 ACK message sent by the receiver of the OMG message to its sender. See Section 2.4.4 for definition and discussion of the ACK message.

2295 **4.2.4.1.2.2.1 MSH Segment (HL7 v2.5.1)**

The MSH segment shall be constructed as defined in [ITI TF-2: 3.30.5.1 MSH – Header Segment](#). Additional specifications for actors complying with the IHE Radiology Technical Framework are defined in Section 2.4.

2300 Field *MSH-9-Message Type* shall have three components. The first component shall have a value of OMG; the second component shall have a value of O19; the third component shall have a value of OMG\_O19.

**4.2.4.1.2.2.2 PID Segment (HL7 v2.5.1)**

All of the fields in the PID segment are optional, except those listed in Table 4.2-5. See Section 4.1.4.1.2.2.3 for further discussion of the PID segment.

2305

**Table 4.2-5: IHE Profile - PID segment**

SEQ	LEN	DT	OPT	TBL#	ITEM#	ELEMENT NAME
3	250	CX	R		00106	Patient Identifier List
5	250	XPN	R		00108	Patient Name
18	250	CX	C		00121	Patient Account Number

*Adapted from the HL7 standard, version 2.5.1*

**4.2.4.1.2.2.3 PV1 Segment (HL7 v2.5.1)**

All of the fields in the PV1 segment are optional, except those listed in Table 4.2-6. See Section 4.1.4.1.2.2.4 for a full discussion of the PV1 segment.

2310

**Table 4.2-6: IHE Profile - PV1 Segment**

SEQ	LEN	DT	OPT	TBL#	ITEM#	ELEMENT NAME
2	1	IS	R	0004	00132	Patient Class
8	250	XCN	R2	0010	00138	Referring Doctor
19	250	CX	C		00149	Visit Number
51	1	IS	C	0326	01226	Visit Indicator

2315

*Adapted from the HL7 standard, version 2.5.1*

Additional usage requirements for these fields may be documented in regional or national extensions to the IHE Radiology Technical Framework (see RAD TF-4).

At least one of the fields *PID-18-Patient Account Number* or *PV1-19-Visit Number* shall be valued.

2320

Field *PV1-51-Visit Indicator* shall be valued with value “V” if the field *PV1-19-Visit Number* is valued. It may be omitted otherwise.

#### 4.2.4.1.2.2.4 ORC Segment (HL7 v2.5.1)

The ORC segment conveys common order information.

**Table 4.2-7: IHE Profile - ORC Segment**

SEQ	LEN	DT	OPT	TBL#	ITEM #	ELEMENT NAME
1	2	ID	R	0119	00215	Order Control
2	22	EI	R		00216	Placer Order Number
3	22	EI	X		00217	Filler Order Number
4	22	EI	C		00218	Placer Group Number
5	2	ID	O	0038	00219	Order Status
6	1	ID	O	0121	00220	Response Flag
7	200	TQ	X		00221	Quantity/Timing
8	200	EIP	C		00222	Parent
9	26	TS	R		00223	Date/Time of Transaction
10	250	XCN	R2		00224	Entered By
11	250	XCN	O		00225	Verified By
12	250	XCN	R		00226	Ordering Provider
13	80	PL	O		00227	Enterer's Location
14	250	XTN	R2		00228	Call Back Phone Number
15	26	TS	O		00229	Order Effective Date/Time
16	250	CE	O		00230	Order Control Code Reason
17	250	CE	R		00231	Entering Organization
18	250	CE	O		00232	Entering Device
19	250	XCN	O		00233	Action By

SEQ	LEN	DT	OPT	TBL#	ITEM #	ELEMENT NAME
20	250	CE	O	0339	01310	Advanced Beneficiary Notice Code
21	250	XON	O		01311	Ordering Facility Name
22	250	XAD	O		01312	Ordering Facility Address
23	250	XTN	O		01313	Ordering Facility Phone Number
24	250	XAD	O		01314	Ordering Provider Address
25	250	CWE	O		01473	Order Status Modifier
26	60	CWE	C	0552	01641	Advanced Beneficiary Notice Override Reason
27	26	TS	O		01642	Filler's Expected Availability Date/Time
28	250	CWE	O	0177	00615	Confidentiality Code
29	250	CWE	O	0482	01643	Order Type
30	250	CNE	O	0483	01644	Enterer Authorization Mode
31	250	CWE	O		02286	Parent Universal Service Identifier

2325

*Adapted from the HL7 Standard, version 2.5.1*

Field *ORC-3-Filler Order Number* shall not be present.

Field *ORC-4-Placer Group Number* shall be valued only if the Order Placer and Order Filler utilize the concept of Order Groups. It shall not be present otherwise.

Field *ORC-7-Quantity/Timing* is not populated. It has been superseded by the TQ1 segment.

2330

Field *ORC-8-Parent* shall be valued only if the current order is a child order (i.e., if the field *ORC-1-Order Control* has a value of CH).

The action to be performed in the OMG message is defined by *ORC-1-Order Control Code*. HL7 defines a number of order control codes.

The following Order Control Codes are supported:

2335

#### Supported Order Control Codes

Value	Description
NW <sup>R</sup>	New order
PA <sup>O</sup>	Parent order
CH <sup>O</sup>	Child order
XO <sup>R</sup>	Change order

*Adapted from the HL7 Standard, version 2.5.1*

<sup>R</sup>=Required; <sup>O</sup>=Optional

Note: The use of Required/Optional superscripts in the Value column is an IHE extension and is not part of the HL7 Standard.

2340 **4.2.4.1.2.2.5 TQ1 Segment (HL7 v2.5.1)**

Deprecated components *ORC-7.4-Start Date/Time* or *OBR-27.4-Start Date/Time* shall not be populated but instead the TQ1 segment shall be used to carry the start date and time of the procedure.

**Table 4.2-8: IHE Profile – TQ1 Segment**

SEQ	LEN	DT	OPT	TBL#	ITEM #	ELEMENT NAME
1	4	SI	O		01627	Set ID – TQ1
2	20	CQ	O		01628	Quantity
3	540	RPT	O	0335	01629	Repeat Pattern
4	20	TM	O		01630	Explicit Time
5	20	CQ	O		01631	Relative Time and Units
6	20	CQ	O		01632	Service Duration
7	26	TS	R		01633	Start Date/Time
8	26	TS	O		01634	End Date/Time
9	250	CWE	O	0485	01635	Priority
10	250	TX	O		01636	Condition Text
11	250	TX	O	0065	01637	Text Instruction
12	10	ID	C	0472	01638	Conjunction
13	20	CQ	O		01639	Occurrence Duration
14	10	NM	O		01640	Total Occurrences

2345

*Adapted from the HL7 Standard, version 2.5.1*

Field *TQ1-7-Start Date/Time* shall contain the date and time of the exam.

**4.2.4.1.2.2.6 OBR Segment (HL7 v2.5.1)****Table 4.2-9: IHE Profile - OBR Segment**

SEQ	LEN	DT	OPT	TBL#	ITEM #	ELEMENT NAME
1	4	SI	O		00237	Set ID – OBR
2	22	EI	R		00216	Placer Order Number
3	22	EI	O		00217	Filler Order Number
4	250	CE	R		00238	Universal Service ID
5	2	ID	O		00239	Priority
6	26	TS	O		00240	Requested Date/time
7	26	TS	O		00241	Observation Date/Time
8	26	TS	O		00242	Observation End Date/Time
9	20	CQ	O		00243	Collection Volume
10	250	XCN	O		00244	Collector Identifier

IHE Radiology Technical Framework, Volume 2 (TF-2): Transactions

SEQ	LEN	DT	OPT	TBL#	ITEM #	ELEMENT NAME
11	1	ID	O	0065	00245	Specimen Action Code
12	250	CE	R2		00246	Danger Code
13	300	ST	C		00247	Relevant Clinical Info.
14	26	TS	X		00248	Specimen Received Date/Time
15	300	SPS	X	0070	00249	Specimen Source
16	250	XCN	R		00226	Ordering Provider
17	250	XTN	O		00250	Order Callback Phone Number
18	60	ST	O		00251	Placer field 1
19	60	ST	O		00252	Placer field 2
20	60	ST	O		00253	Filler Field 1
21	60	ST	O		00254	Filler Field 2
22	26	TS	O		00255	Results Rpt/Status Chng - Date/Time
23	40	MOC	O		00256	Charge to Practice
24	10	ID	O	0074	00257	Diagnostic Serv Sect ID
25	1	ID	O	0123	00258	Result Status
26	400	PRL	O		00259	Parent Result
27	200	TQ	X		00221	Quantity/Timing
28	250	XCN	O		00260	Result Copies To
29	200	EIP	C		00261	Parent
30	20	ID	R2	0124	00262	Transportation Mode
31	250	CE	R2		00263	Reason for Study
32	200	NDL	O		00264	Principal Result Interpreter
33	200	NDL	O		00265	Assistant Result Interpreter
34	200	NDL	O		00266	Technician
35	200	NDL	O		00267	Transcriptionist
36	26	TS	O		00268	Scheduled Date/Time
37	4	NM	O		01028	Number of Sample Containers
38	250	CE	O		01029	Transport Logistics of Collected Sample
39	250	CE	O		01030	Collector's Comment
40	250	CE	O		01031	Transport Arrangement Responsibility
41	30	ID	R2	0224	01032	Transport Arranged
42	1	ID	O	0225	01033	Escort Required
43	250	CE	O		01034	Planned Patient Transport Comment
44	250	CE	O	0088	00393	Procedure Code
45	250	CE	O	0340	01036	Procedure Code Modifier

SEQ	LEN	DT	OPT	TBL#	ITEM #	ELEMENT NAME
46	250	CE	R2	0411	01474	Placer Supplemental Service Information
47	250	CE	R2	0411	01475	Filler Supplemental Service Information
48	250	CWE	R2	0476	01646	Medically Necessary Duplicate Procedure Reason
49	2	IS	O	0507	01647	Result Handling
50	250	CWE	O		02286	Parent Universal Service Identifier

*Adapted from the HL7 Standard, version 2.5.1*

2350 Field *OBR-13-Relevant Clinical Info* shall be populated if the patient record contains any medical alerts that may be relevant to the order and, in particular, need to be communicated to the technologist.

Field *OBR-27-Quantity/Timing* shall not be present. The date and time of the exam shall be carried in field *TQ1-7-Start Date/Time*.

2355 Field *OBR-46-Placer Supplemental Service Information* holds the laterality (Left/Right) indicator (when used). This element shall be populated if the procedure has laterality and the Universal Service ID code in *OBR-4* does not encode laterality. This element shall be empty otherwise. Field *OBR-15-Specimen Source*, which had formerly been adapted for this use by the IHE Technical Framework and has been deprecated in HL7 Version 2.5.1, shall not be present.

2360 See RAD TF-2x: Appendix B for details.

Per the HL7 Standard, IHE recommends that the fields in ORC and OBR segments given in the following table contain the same information.

**Identical Element Mappings between ORC and OBR Segments**

Element Name	ORC Segment Element	OBR Segment Element
Placer Order Number	ORC-2	OBR-2
Filler Order Number	ORC-3	OBR-3
Parent	ORC-8	OBR-29

**4.2.4.1.3 Expected Actions**

2365 Department System Scheduler/Order Filler shall accept the order information for fulfillment. If error in data prevents it from fulfilling the order, it shall notify the Order Placer by returning proper information in the ACK message.

2370 For actors implementing the HL7 v2.5.1 Message Semantics, the Order Placer shall not change an order that has already been started, e.g., one for which Order Filler has transmitted an “In-Progress” status in the Order Status message in the [RAD-3] transaction (see Section 4.3.4.2). However, if the Order Filler receives the change order message after it has sent the Order Status Update message (for example, in a case of a race condition between two messages), the Order

Filler shall accept the change order and perform transaction Procedure Update [RAD-13] to notify Image Manager.

2375 **4.2.4.2 Order Management - Order Cancelled by Order Placer**

**4.2.4.2.1 Trigger Events**

The following event will trigger the ORM messages within systems implementing HL7 v2.3.1:

ORM – Order Placer cancels an order (control code = CA).

2380 ORM – Order Placer discontinues (attempts to stop) an ongoing order (control code = DC).

The following event will trigger the OMG messages within systems implementing HL7 v2.5.1:

OMG – Order Placer cancels an order (control code = CA).

OMG – Order Placer discontinues (attempts to stop) an ongoing order (control code = DC).

2385 **4.2.4.2.2 Message Semantics**

Message semantics are defined for both HL7 v2.3.1 and HL7 v2.5.1. The Profile and/or Options being claimed that incorporate this transaction will specify whether actors are required to support one, the other, or both sets of semantics.

**4.2.4.2.2.1 Message Semantics (HL7 v.2.3.1)**

2390 HL7 2.3.1 Chapter 4 ORM message. Refer to HL7 standard for general message semantics. Refer to Section 4.2.4.1.2.1 above for detailed requirements of the ORM message.

**Note:** Additional qualifications to the level of specification and HL7 profiling are stated in Section 2.3.

Required segments are listed below. Other segments are optional.

2395

ORM	General Order Message	Chapter in HL7 2.3.1
MSH	Message Header	2
PID	Patient Identification	3
PV1	Patient Visit	3
ORC	Common Order	4

Each message shall be acknowledged by the HL7 ACK message sent by the receiver of ADT message to its sender. See Section 2.4.3 “Acknowledgement Modes” for definition and discussion of the ACK message.

**4.2.4.2.2.1.1 MSH Segment (HL7 v2.3.1)**

2400 MSH segment shall be constructed as defined in the Section 2.4.2.2 “Message Control”.



Field *MSH-9 Message Type* shall have at least two components. The first component shall have a value of “ORM”; the second component shall have a value of O01. The third component is optional; however, if present, it shall have a value of ORM\_O01.

**4.2.4.2.2.1.2 PID Segment (HL7 v2.3.1)**

2405 All of the fields in PID segment are optional, except those listed in Table 4.2-10. See Section 4.1.4.1.2.1.3 for the list of all fields of the PID segment.

**Table 4.2-10: IHE Profile - PID segment**

SEQ	LEN	DT	OPT	TBL#	ITEM#	ELEMENT NAME
3	20	CX	R		00106	Patient Identifier List
5	48	XPN	R		00108	Patient Name
18	20	CX	C		00121	Patient Account Number

*Adapted from the HL7 standard, version 2.3.1*

**4.2.4.2.2.1.3 PV1 Segment (HL7 v2.3.1)**

2410 All of the fields in PV1 segment are optional, except those listed in Table 4.2-11. See Section 4.1.4.1.2.1.4 for the list of all fields of the PV1 segment.

**Table 4.2-11: IHE Profile - PV1 Segment**

SEQ	LEN	DT	OPT	TBL#	ITEM#	ELEMENT NAME
2	1	IS	R	0004	00132	Patient Class
19	20	CX	C		00149	Visit Number
51	1	IS	C	0326	01226	Visit Indicator

*Adapted from the HL7 standard, version 2.3.1*

2415 At least one of the fields *PID-18 Patient Account Number* or *PV1-19 Visit Number* shall be valued. Additional requirements for the presence of value in these fields may be documented in regional or national extensions to the IHE Radiology Technical Framework (see RAD TF-4).

Field *PV1-51 Visit Indicator* shall be valued with value “V” if the field *PV1-19 Visit Number* is present. May be omitted otherwise.

**4.2.4.2.2.1.4 ORC Segment (HL7 v2.3.1)**

2420 All of the fields in ORC segment are optional, except those listed in Table 4.2-12. See Section 4.2.4.1.2.1.4 for the list of all fields of the ORC segment.

**Table 4.2-12: IHE Profile - ORC Segment**

SEQ	LEN	DT	OPT	TBL#	ITEM #	ELEMENT NAME
1	2	ID	R	0119	00215	Order Control

SEQ	LEN	DT	OPT	TBL#	ITEM #	ELEMENT NAME
2	22	EI	R		00216	Placer Order Number

*Adapted from the HL7 Standard, version 2.3.1*

2425 The action to be performed in the ORM message is defined by the Order Control code passed as part of the message. HL7 defines a number of Order Control codes.

The order control codes below shall be supported.

**IHE Profile - Supported Order Control Codes**

Value	Description
CA	Cancel order request
DC	Discontinue Order request

**4.2.4.2.2 Message Semantics (HL7 v2.5.1)**

2430 The HL7 v2.5.1 Message Semantics implement the Chapter 4 OMG message. Refer to the HL7 standard for general message semantics. Refer to Section 4.2.4.1.2.2 above for detailed requirements of the OMG message.

Note: Additional qualifications to the level of specification and HL7 profiling are stated in Section 2.3.

Required segments are listed below. Other segments are optional.

OMG	General Clinical Order Message	Chapter in HL7 v2.5.1
MSH	Message Header	2
PID	Patient Identification	3
PV1	Patient Visit	3
ORC	Common Order	4

2435 Each message shall be acknowledged by the HL7 ACK message sent by the receiver of the OMG message to its sender. See Section 2.4.4.3 “Acknowledgement Modes” for definition and discussion of the ACK message.

**4.2.4.2.2.1 MSH Segment (HL7 v2.5.1)**

2440 The MSH segment shall be constructed as defined in [ITI TF-2: 3.30.5.1](#) MSH – Header Segment. Additional specifications for actors complying with the IHE Radiology Technical Framework are defined in Section 2.4.

Field *MSH-9-Message Type* shall have three components. The first component shall have a value of OMG; the second component shall have a value of O19; the third component shall have a value of OMG\_O19.

2445 **4.2.4.2.2.2 PID Segment (HL7 v2.5.1)**

All of the fields in the PID segment are optional, except those listed in Table 4.2-13. See Section 4.1.4.1.2.2.3 for further discussion of the PID segment.

**Table 4.2-13: IHE Profile - PID segment**

SEQ	LEN	DT	OPT	TBL#	ITEM#	ELEMENT NAME
3	250	CX	R		00106	Patient Identifier List
5	250	XPN	R		00108	Patient Name
18	250	CX	C		00121	Patient Account Number

*Adapted from the HL7 standard, version 2.5.1*

2450 **4.2.4.2.2.3 PV1 Segment (HL7 v2.5.1)**

All of the fields in the PV1 segment are optional, except those listed in Table 4.2-14. See Section 4.1.4.1.2.2.4 for a full discussion of the PV1 segment.

**Table 4.2-14: IHE Profile - PV1 Segment**

SEQ	LEN	DT	OPT	TBL#	ITEM#	ELEMENT NAME
2	1	IS	R	0004	00132	Patient Class
19	250	CX	C		00149	Visit Number
51	1	IS	C	0326	01226	Visit Indicator

*Adapted from the HL7 standard, version 2.5.1*

2455 At least one of the fields *PID-18-Patient Account Number* or *PV1-19-Visit Number* shall be valued. Additional usage requirements for these fields may be documented in regional or national extensions to the IHE Technical Framework (see RAD TF-4).

Field *PV1-51-Visit Indicator* shall be valued with value “V” if the field *PV1-19-Visit Number* is valued. It may be omitted otherwise.

2460 **4.2.4.2.2.4 ORC Segment (HL7 v2.5.1)**

All of the fields in ORC segment are optional, except those listed in Table 4.2-15. See Section 4.2.4.1.2.2.4 for the list of all fields of the ORC segment.

**Table 4.2-15: IHE Profile - ORC Segment**

SEQ	LEN	DT	OPT	TBL#	ITEM #	ELEMENT NAME
1	2	ID	R	0119	00215	Order Control
2	22	EI	R		00216	Placer Order Number

*Adapted from the HL7 Standard, version 2.5.1*

2465 The action to be performed in the OMG message is defined by the Order Control code passed as part of the message. HL7 defines a number of Order Control codes.

The order control codes below shall be supported.

**IHE Profile - Supported Order Control Codes**

Value	Description
CA	Cancel order request
DC	Discontinue Order request

**4.2.4.2.3 Expected Actions**

2470 After receiving the Order Management message with the control code CA, DSS/Order Filler shall discard the record of the order and shall not attempt to schedule or otherwise to fulfill it. If the DSS/Order Filler has already scheduled the procedures corresponding to the order, it has to perform transaction Procedure Update [RAD-13] (see Section 4.13) to notify the Image Manager of order cancellation.

2475 Order Placer shall not cancel order that has already been started, i.e., the one for which Order Filler transmitted the “In-Progress” status (see Section 4.3.4.2). However, if the Order Filler receives the cancellation message after it has sent the Status Update message (for example, in a case of a race condition between two messages), Order Filler shall accept order cancellation and perform transaction Procedure Update [RAD-13] to notify Image Manager.

2480 It is expected that in most cases Order Placer will utilize the Order Management message with the control code of CA. However, in some cases (such as with recurring orders – to stop the order fulfillment before all its parts were completed), Order Placer and Order Filler may agree on a use of the Order Management message with the control code DC. Upon receiving such Order Management message, DSS/Order Filler shall perform transaction Procedure Update [RAD-13]

2485 (see Section 4.13) to notify the Image Manager of order discontinuation

## 4.3 Filler Order Management [RAD-3]

### 4.3.1 Scope

2490 This transaction is used by the Order Filler to inform the Order Placer about the orders it creates and cancels, including the status of the orders it is fulfilling.

A 1:1 relationship between Placer Order and Filler Order shall be maintained.

For an illustration of mapping between transactions [RAD-2], [RAD-3], [RAD-5], [RAD-6] and [RAD-7], see the IHE white paper “Code Mapping in IHE Radiology Profiles”, [https://www.ihe.net/uploadedFiles/Documents/Radiology/IHE\\_RAD\\_White-Paper\\_Codes.pdf](https://www.ihe.net/uploadedFiles/Documents/Radiology/IHE_RAD_White-Paper_Codes.pdf).

### 2495 4.3.2 Actor Roles

**Actor:** Order Placer

**Role:** Receives new order, order change (HL7 v2.5.1 Message Semantics) and order cancellation requests from Order Filler. Receives Order Status updates from Order Filler.

**Actor:** Department System Scheduler/Order Filler

2500 **Role:** Creates new or cancels existing orders; sends notifications of order status to the Order Placer.

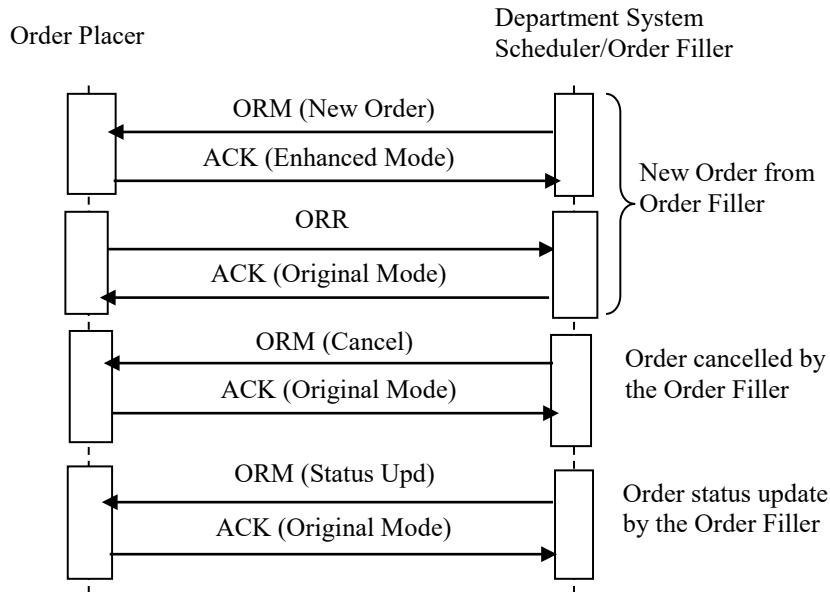
### 4.3.3 Referenced Standards

HL7 v2.3.1 Chapter 4

HL7 v2.5.1 Chapter 4

### 2505 4.3.4 Messages

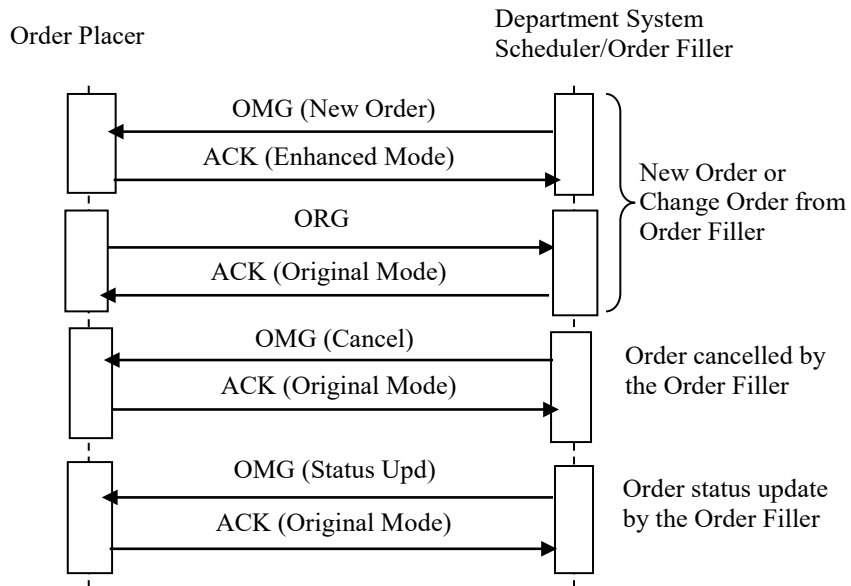
The following diagram illustrates interactions between actors implementing HL7 v2.3.1



2510

**Figure 4.3.4-1: Interactions between actors implementing HL7 v2.3.1**

The following diagram illustrates interactions between actors implementing HL7 v2.5.1:



**Figure 4.3.4-2: Interactions between actors implementing HL7 v2.5.1**

2515 **4.3.4.1 Filler Order Management – New Order from Order Filler or Change Order from Order Filler**

**4.3.4.1.1 Trigger Events**

Actors implementing the HL7 v2.3.1 Message Semantics shall implement the following:

2520 ORM - Department System Scheduler/Order Filler creates a new order or cancels an order (control code = SN).

ORR – Order Placer replies (control code = NA).

Actors implementing the HL7 v2.5.1 Message Semantics shall implement the following:

OMG - Department System Scheduler/Order Filler creates a new order or cancels an order (control code = SN).

2525 OMG – Department. System Scheduler/Order Filler changes an order (control code = XX).

ORG – Order Placer replies (control code = NA).

2530 The ORR (HL7 v2.3.1) or ORG (HL7 v2.5.1) messages are sent by the Order Placer as application acknowledgements to convey the Order Placer Number in those cases where the DSS/Order Filler creates a new Order or changes an existing Order. Enhanced acknowledgement mode shall not be used in Order Cancel or Order Status Update messages.

**4.3.4.1.2 Message Semantics**

2535 Message semantics are defined for both HL7 v2.3.1 and HL7 v2.5.1. The Profile and/or Options being claimed that incorporate this transaction will specify whether actors are required to support one, the other, or both sets of semantics.

**4.3.4.1.2.1 Message Semantics (HL7 v2.3.1)**

HL7 v2.3.1 Chapter 4 ORM message. Refer to HL7 Standard for general message semantics. Refer to Section 4.2.4.1.2.1 above for detailed requirements for the ORM message.

See Section 2.4.2.2 of this document for MSH segment definition.

2540 Note: Additional qualifications to the level of specification and HL7 profiling are stated in Section 2.3.

Required segments are listed below. Other segments are optional.

ORM	General Order Message	Chapter in HL7 2.3.1
MSH	Message Header	2
PID	Patient Identification	3
PV1	Patient Visit	3
ORC	Common Order	4
OBR	Order Detail	4

2545 When the Order Placer receives an ORM message, it shall send an HL7 ACK message to the DSS/Order Filler. See Section 2.4.2.1 Acknowledgement Message for definition of the ACK message.

When the Order Placer receives an ORM for a New Order, the Order Placer shall also place a corresponding order and then send an ORR message for the placed order to the DSS/Order Filler (see Figure 4.3.4-1).

2550 See HL7 v2.3.1 Chapter 4 ORR message. Refer to the HL7 Standard for general message semantics.

ORR (Success)	General Order Message	Chapter in HL7 2.3.1
MSH	Message Header	2
MSA	Message Acknowledgement	2
ORC	Common Order	4
OBR	Order Detail	4

ORR (Error)	General Order Message	Chapter in HL7 2.3.1
MSH	Message Header	2
MSA	Message Acknowledgement	2
ERR	Error	2

Field *MSA-1 Acknowledgement Code* shall contain a code according to the Original Acknowledge Mode.

2555 When the DSS/Order Filler receives an ORR message, it shall send an HL7 ACK message to the Order Placer. See Section 2.4.2.1 Acknowledgement Message for definition of the ACK message.

#### 4.3.4.1.2.1.1 MSH Segment (HL7 v2.3.1)

MSH segment shall be constructed as defined in Section 2.4.2.2 “Message Control”.

2560 Field *MSH-9 Message Type* shall have at least two components. The first component shall have a value of “ORM” for ORM message and “ORR” for ORR message; the second component shall have value of O01 or O02, respectively. The third component is optional; however, if present, it shall have a value of ORM\_O01 or ORR\_O02, respectively.

2565 Field *MSH-15 Accept Acknowledgement Type* shall be populated with the value “AL” if MSH-16 is populated; otherwise it shall be left empty.

Field *MSH-16 Application Acknowledgement Type* shall be populated with the value “AL” to request an application acknowledgement if the ORM message is for New Order message; otherwise it shall be left empty.



**4.3.4.1.2.1.2 MSA Segment (HL7 v2.3.1)**

2570 MSA segment in the ACK, ORR (Success), or ORR (Error) message shall be constructed as defined in the Section 2.4.3 “Acknowledgement Modes”.

Field *MSA-1 Acknowledgement Code* shall:

- contain a code according to the Original Acknowledge Mode if it is the acknowledgement message for the Order Cancelled or Order Status Update message, or for the ORR message.
- contain a code according to the Enhanced Acknowledgement Mode if it is the acknowledgement message for the New Order message.

Field *MSA-6 Error condition* in ORR (Error) shall have the Error code value of 204 (Unknown Key Identifier)

2580 **4.3.4.1.2.1.3 PID Segment (HL7 v2.3.1)**

All of the fields in PID segment are optional, except those listed in Table 4.3-1. See Section 4.1.4.1.2.1.3 for the list of all fields of the PID segment.

**Table 4.3-1: IHE Profile - PID segment**

SEQ	LEN	DT	OPT	TBL#	ITEM#	ELEMENT NAME
3	20	CX	R		00106	Patient Identifier List
5	48	XP	R		00108	Patient Name
18	20	CX	C		00121	Patient Account Number

*Adapted from the HL7 standard, version 2.3.1*

2585 **4.3.4.1.2.1.4 PV1 Segment (HL7 v2.3.1)**

All of the fields in PV1 segment are optional, except those listed in Table 4.3-2. See Section 4.1.4.1.2.1.4 for the list of all fields of the PV1 segment.

**Table 4.3-2: IHE Profile - PV1 Segment**

SEQ	LEN	DT	OPT	TBL#	ITEM#	ELEMENT NAME
2	1	IS	R	0004	00132	Patient Class
19	20	CX	C		00149	Visit Number
51	1	IS	C	0326	01226	Visit Indicator

*Adapted from the HL7 standard, version 2.3.1*

2590 Additional requirements for the presence of value in these fields may be documented in regional or national extensions to the IHE Radiology Technical Framework (see RAD TF-4).

At least one of the fields *PID-18 Patient Account Number* or *PV1-19 Visit Number* shall be valued.

2595 Field *PVI-51 Visit Indicator* shall be valued with value “V” if the field *PVI-19 Visit Number* is present. May be omitted otherwise.

**4.3.4.1.2.1.5 ORC Segment (HL7 v2.3.1)**

All of the fields in ORC segment are optional, except those listed in Table 4.3-3. See Section 4.2.4.1.2.1.4 for the list of all fields of the ORC segment.

**Table 4.3-3: IHE Profile - ORC Segment**

SEQ	LEN	DT	OPT	TBL#	ITEM #	ELEMENT NAME
1	2	ID	R	0119	00215	Order Control
2	22	EI	C		00216	Placer Order Number
3	22	EI	R		00217	Filler Order Number
4	22	EI	C		00218	Placer Group Number
7	200	TQ	R		00221	Quantity/Timing
9	26	TS	R		00223	Date/Time of Transaction
10	120	XCN	R2		00224	Entered By
12	120	XCN	R		00226	Ordering Provider
14	40	XTN	R2		00228	Call Back Phone Number
17	60	CE	R		00231	Entering Organization

2600

*Adapted from the HL7 Standard, version 2.3.1*

Field ORC-1 Order Control shall have the value of SN in the ORM message and the value NA in the ORR message.

Field *ORC-2 Placer Order Number* shall be valued only in the ORR message and omitted in the ORM message.

2605

Field *ORC-4 Placer Group Number* shall be valued only if the Order Placer and Order Filler utilize concept of Order Groups. Shall not be present otherwise.

**4.3.4.1.2.1.6 OBR Segment (HL7 v2.3.1)**

All of the fields in OBR segment are optional, except those listed in Table 4.3-4. See Section 4.2.4.1.2.1.5 for the list of all fields of the OBR segment.

2610

**Table 4.3-4: IHE Profile - OBR Segment**

SEQ	LEN	DT	OPT	TBL#	ITEM #	ELEMENT NAME
2	75	EI	C		00216	Placer Order Number
3	75	EI	R		00217	Filler Order Number
4	200	CE	R		00238	Universal Service ID
12	60	CE	R2		00246	Danger Code
13	300	ST	C		00247	Relevant Clinical Info.

SEQ	LEN	DT	OPT	TBL#	ITEM #	ELEMENT NAME
15	300	CM	C	0070	00249	Specimen Source
16	80	XCN	R		00226	Ordering Provider
27	200	TQ	R		00221	Quantity/Timing
30	20	ID	R2	0124	00262	Transportation Mode
31	300	CE	R2		00263	Reason for Study
41	30	ID	R2	0224	01032	Transport Arranged

*Adapted from the HL7 Standard, version 2.3.1*

Field *OBR-13 Relevant Clinical Info* shall be populated if patient record contains any medical alerts that may be relevant to the order and, in particular, need to be communicated to the technologist.

2615 Field *OBR-15 Specimen Source* holds the laterality (Left/Right) indicator (when used) in the <site modifier (CE)> component. See RAD TF-2x: Appendix B for details.

Per the HL7 Standard, IHE recommends that some fields in ORC and OBR segments contain the same information, as described in Section 4.2.4.1.2.1.5.

2620 For the ORR message, all required fields in the OBR segment, except *OBR-2 Placer Order Number*, shall be copied by Order Placer from the ORM message received from the Order Filler. Value of the field *OBR-2 Placer Order Number* shall be generated by the Order Placer.

#### 4.3.4.1.2.1.7 ERR Segment (HL7 v2.3.1)

ERR segment in the ORR (Error) message shall be constructed as defined in Section 2.4.3 “Acknowledgement Modes”.

2625 Field *ERR-1 Error code and location* in ORR (Error) shall have the Error code value of 204 (Unknown Key Identifier).

#### 4.3.4.1.2.2 Message Semantics (HL7 v2.5.1)

2630 The HL7 v2.5.1 Message Semantics implement the Chapter 4 OMG message. Refer to the HL7 Standard for general message semantics. Refer to Section 4.2.4.1.2.2 above for detailed requirements for the OMG message.

See Section 2.4 and Section 4.2 for the MSH segment definition.

Note: Additional qualifications to the level of specification and HL7 profiling are stated in Section 2.3 above.

Required segments are listed below. Other segments are optional.

OMG	General Clinical Order Message	Chapter in HL7 v2.5.1
MSH	Message Header	2
PID	Patient Identification	3

OMG	General Clinical Order Message	Chapter in HL7 v2.5.1
PV1	Patient Visit	3
ORC	Common Order	4
TQ1	Timing / Quantity	4
OBR	Order Detail	4

2635 When the Order Placer receives an OMG message, it shall send an HL7 ACK message to the DSS/Order Filler. See Section 2.4.2.1 Acknowledgement Message for definition of the ACK message.

2640 When the Order Placer receives an OMG for a New Order or Change Order, the Order Placer shall also place a corresponding order and then send an ORG message for the placed order to the DSS/Order Filler (see Figure 4.3.4-2).

HL7 v2.5.1 Chapter 4 ORG message. Refer to HL7 Standard for general message semantics.

ORG (Success)	General Clinical Order Message Acknowledgment	Chapter in HL7 v2.5.1
MSH	Message Header	2
MSA	Message Acknowledgement	2
ORC	Common Order	4
TQ1	Timing / Quantity	4
OBR	Order Detail	4

ORG (Error)	General Clinical Order Message Acknowledgment	Chapter in HL7 v2.5.1
MSH	Message Header	2
MSA	Message Acknowledgement	2
[{ ERR }]	Error	2

2645 Field *MSA-1 Acknowledgement Code* shall contain a code according to the Original Acknowledge Mode.

Each ORG message shall be acknowledged by an HL7 ACK message sent by the DSS/OF to the Order Placer. See Section 2.4.2.1 Acknowledgement Message for definition of the ACK message.

#### 4.3.4.1.2.2.1 MSH Segment (HL7 v2.5.1)

2650 The MSH segment shall be constructed as defined in [ITI TF-2: 3.30.5.1 MSH – Header Segment](#). Additional specifications for actors complying with the IHE Radiology Technical Framework are defined in Section 2.4.

Field MSH-9-Message Type shall have three components.

2655 For the order message, the first component shall have a value of OMG; the second component shall have a value of O19; the third component shall have a value of OMG\_O19.

For the order acknowledgment message, the first component shall have a value of ORG; the second component shall have value of O20; the third component shall have a value of ORG\_O20.

2660 Field *MSH-15 Accept Acknowledgement Type* shall be populated with the value “AL” if MSH-16 is populated, otherwise shall be left empty.

Field *MSH-16 Application Acknowledgement Type* shall be populated with the value “AL” to request for application acknowledgement if the OMG message is for New Order or Change Order message, otherwise shall be left empty.

**4.3.4.1.2.2.2 MSA Segment (HL7 v2.5.1)**

2665 The MSA segment in the ACK, ORG (Success), or ORG (Error) message shall be constructed as defined in Section 2.4.4.3 “Acknowledgement Modes”.

Field *MSA-1 Acknowledgement Code* shall:

- contain a code according to the Original Acknowledge Mode if it is the acknowledgement message for the Order Cancelled or Order Status Update message, or the ORR message.
- contain a code according to the Enhanced Acknowledgement Mode if it is the acknowledgement message for the New Order or Change Order message.

Field *MSA-6-Error condition* in an ACK (Error) or ORG (Error) shall have the error code value of 204 (Unknown Key Identifier) in case of an error.

2675 **4.3.4.1.2.2.3 PID Segment (HL7 v2.5.1)**

All of the fields in the PID segment are optional, except those listed in Table 4.3-5. See Section 4.1.4.1.2.2.3 for further discussion of the PID segment.

**Table 4.3-5: IHE Profile - PID segment**

SEQ	LEN	DT	OPT	TBL#	ITEM#	ELEMENT NAME
3	250	CX	R		00106	Patient Identifier List
5	250	XP	R		00108	Patient Name
18	250	CX	C		00121	Patient Account Number

*Adapted from the HL7 standard, version 2.5.1*

2680 **4.3.4.1.2.2.4 PV1 Segment (HL7 v2.5.1)**

All of the fields in the PV1 segment are optional, except those listed in Table 4.3-6. See Section 4.1.4.1.2.2.4 for a full discussion of the PV1 segment.

**Table 4.3-6: IHE Profile - PV1 Segment**

SEQ	LEN	DT	OPT	TBL#	ITEM#	ELEMENT NAME
2	1	IS	R	0004	00132	Patient Class
19	250	CX	C		00149	Visit Number
51	1	IS	C	0326	01226	Visit Indicator

*Adapted from the HL7 standard, version 2.5.1*

2685 Additional requirements for the presence of value in these fields may be documented in regional or national extensions to the IHE Radiology Technical Framework (see RAD TF-4).

At least one of the fields *PID-18 Patient Account Number* or *PV1-19 Visit Number* shall be valued. PID-18 and/or PV1-19 is required if it was present in the registration message (trigger event A01, A04 or A05) that is being cancelled by this transaction.

2690 Field *PV1-51 Visit Indicator* shall be valued with value “V” if the field *PV1-19 Visit Number* is valued. It may be omitted otherwise.

**4.3.4.1.2.2.5 ORC Segment (HL7 v2.5.1)**

All of the fields in ORC segment are optional, except those listed in Table 4.3-7. See Section 4.2.4.1.2.2.4 for the list of all fields of the ORC segment.

2695

**Table 4.3-7: IHE Profile - ORC Segment**

SEQ	LEN	DT	OPT	TBL#	ITEM #	ELEMENT NAME
1	2	ID	R	0119	00215	Order Control
2	22	EI	C		00216	Placer Order Number
3	22	EI	R		00217	Filler Order Number
4	22	EI	C		00218	Placer Group Number
7	200	TQ	X		00221	Quantity/Timing
9	26	TS	R		00223	Date/Time of Transaction
10	250	XCN	R2		00224	Entered By
12	250	XCN	R		00226	Ordering Provider
14	250	XTN	R2		00228	Call Back Phone Number
17	250	CE	R		00231	Entering Organization

*Adapted from the HL7 Standard, version 2.5.1*

Field *ORC-1-Order Control* shall have the value of SN for “New Order” or XX for “Change Order” in the OMG message and the value NA in the ORG message.

Field *ORC-2-Placer Order Number*

- 2700
- shall be empty in the OMG message for the “New Order” workflow
  - shall be valued, if known, in the OMG message for the “Order Cancelled” and “Order Status Update” workflows

- shall be valued in the ORG message

2705

Note: Depending on when the DSS/OF receives the ORG message from the Order Placer, DSS/OF may not yet be aware of the Placer Order Number when it sent an Order Cancelled or Order Status Update.

Field *ORC-4-Placer Group Number* shall be valued only if the Order Placer and Order Filler utilize concept of Order Groups. They shall not be present otherwise.

Field *ORC-7-Quantity/Timing* shall not be present. The date and time of the exam shall be carried in field *TQ1-7-Start Date/Time*.

2710

#### 4.3.4.1.2.2.6 TQ1 Segment (HL7 v2.5.1)

Implementations that support the HL7 v2.5.1 Message Semantics shall not populate deprecated components *ORC-7.4-Start Date/Time* or *OBR-27.4-Start Date/Time* but instead shall use the TQ1 segment to carry the start date and time of the procedure.

**Table 4.3-8: IHE Profile – TQ1 Segment**

SEQ	LEN	DT	OPT	TBL#	ITEM #	ELEMENT NAME
1	4	SI	O		01627	Set ID – TQ1
2	20	CQ	O		01628	Quantity
3	540	RPT	O	0335	01629	Repeat Pattern
4	20	TM	O		01630	Explicit Time
5	20	CQ	O		01631	Relative Time and Units
6	20	CQ	O		01632	Service Duration
7	26	TS	R		01633	Start Date/Time
8	26	TS	O		01634	End Date/Time
9	250	CWE	O	0485	01635	Priority
10	250	TX	O		01636	Condition Text
11	250	TX	O	0065	01637	Text Instruction
12	10	ID	C	0427	01638	Conjunction
13	20	CQ	O		01639	Occurrence Duration
14	10	NM	O		01640	Total Occurrences

2715

*Adapted from the HL7 Standard, version 2.5.1*

Field *TQ1-7-Start Date/Time* shall contain the date and time of the exam.

#### 4.3.4.1.2.2.7 OBR Segment (HL7 v2.5.1)

All of the fields in the OBR segment are optional, except those listed in Table 4.3-9. See Section 4.2.4.1.2.2.6 for the list of all fields of the OBR segment.

2720

**Table 4.3-9: IHE Profile - OBR Segment**

SEQ	LEN	DT	OPT	TBL#	ITEM #	ELEMENT NAME
2	22	EI	C		00216	Placer Order Number
3	22	EI	R		00217	Filler Order Number
4	250	CE	R		00238	Universal Service ID
12	250	CE	R2		00246	Danger Code
13	300	ST	C		00247	Relevant Clinical Info.
15	300	SPS	X	0070	00249	Specimen Source
16	80	XCN	R		00226	Ordering Provider
27	200	TQ	X		00221	Quantity/Timing
30	20	ID	R2	0124	00262	Transportation Mode
31	250	CE	R2		00263	Reason for Study
41	30	ID	R2	0224	01032	Transport Arranged
46	250	CE	C	0411	01474	Placer Supplemental Service Information

*Adapted from the HL7 Standard, version 2.5.1*

Field *OBR-13-Relevant Clinical Info* shall be populated if patient record contains any medical alerts that may be relevant to the order and, in particular, need to be communicated to the technologist.

2725 Field *OBR-27-Quantity/Timing* shall not be present. The date and time of the exam shall be carried in field *TQ1-7-Start Date/Time*.

2730 Field *OBR-46-Placer Supplemental Service Information* holds the laterality (Left/Right) indicator (when used). This element shall be populated if the procedure has laterality and the Universal Service ID code in *OBR-4* does not encode laterality. This element shall be empty otherwise. Field *OBR-15-Specimen Source*, which had formerly been adapted for this use by the IHE Technical Framework and has been deprecated in HL7 Version 2.5.1, shall not be present. See RAD TF-2x: Appendix B for details.

Per the HL7 Standard, IHE recommends that some fields in the ORC and OBR segments contain the same information, as described in Section 4.2.4.1.2.2.6.

2735 For the ORG message, all required fields in the OBR segment, except *OBR-2-Placer Order Number*, shall be copied by Order Placer from the OMG message received from the Order Filler. The value of the field *OBR-2-Placer Order Number* shall be generated by the Order Placer.

#### **4.3.4.1.2.2.8 ERR Segment (HL7 v2.5.1 Option)**

The ERR segment in the ORG (Error) message shall be constructed as defined in Section 2.4.

2740 The first component of Field *ERR-1-Error code* and location in the ORG (Error) message shall have the error code value of 204 (Unknown Key Identifier).



**4.3.4.1.3 Expected Actions**

2745 If the Order Placer accepts and registers order information transmitted from the Order Filler in the Order Management message, it shall assign its unique number to it and convey that number to order Filler in the ORR (Success) message for HL7 v2.3.1 and the ORG (Success) message for HL7 v2.5.1. In turn, the Order Filler shall register received Order Placer number and include it into the subsequent communication of order status with Order Placer, as well as procedure-related information to the Image Manager and Acquisition Modality (see Sections 4.4 and 4.5).

2750 If the Order Placer cannot accept order information transmitted from the Order Filler in the Order Management message (e.g., Patient ID does not exist anymore due to a Patient Update-Cancel registration the Order Placer just received), it shall convey the rejection by returning an ORR (Error) message for HL7 v2.3.1 and the ORG (Error) message for HL7 v2.5.1.

**4.3.4.2 Filler Order Management - Order Status Update**

2755 The Order Status Update Message is used by the DSS/Order Filler to notify Order Placer about changes in the status of the order as it is being fulfilled by the DSS/Order Filler.

**4.3.4.2.1 Trigger Events**

Actors implementing the HL7 v2.3.1 Message Semantics shall implement the following:

ORM - Department System Scheduler/Order Filler updates an order status (control code = SC).

2760 Actors implementing the HL7 v2.5.1 Message Semantics shall implement the following:

OMG - Department System Scheduler/Order Filler updates an order status (control code = SC).

**4.3.4.2.2 Message Semantics**

**4.3.4.2.2.1 Message Semantics (HL7 v2.3.1)**

2765 HL7 2.3.1 Chapter 4 ORM message. Refer to HL7 Standard for general message semantics. See Section 4.1 of this document for MSH segment definition.

Note: Additional qualifications to the level of specification and HL7 profiling are stated in Section 2.

Required segments are listed below. Other segments are optional.

ORM	General Order Message	Chapter in HL7 2.3.1
MSH	Message Header	2
ORC	Common Order	4

2770 **4.3.4.2.2.1.1 MSH Segment (HL7 v2.3.1)**

MSH segment shall be constructed as defined in the Section 2.4.2.2 “Message Control”.

Field *MSH-9 Message Type* shall have at least two components. The first component shall have a value of “ORM”; the second component shall have value of O01. The third component is optional; however, if present, it shall have a value of ORM\_O01.

2775 **4.3.4.2.2.1.2 ORC Segment (HL7 v2.3.1)**

All of the fields in ORC segment are optional, except those listed in Table 4.3-10. See Section 4.2.4.1.2.1.4 for the list of all fields of the ORC segment.

**Table 4.3-10: IHE Profile - ORC Segment**

SEQ	LEN	DT	OPT	TBL#	ITEM #	ELEMENT NAME
1	2	ID	R	0119	00215	Order Control
2	22	EI	R		00216	Placer Order Number
3	22	EI	R		00217	Filler Order Number
5	2	ID	R	0038	00219	Order Status

*Adapted from the HL7 Standard, version 2.3.1*

2780 When an Order Status Update (control code = SC) message is received at the Order Placer, the element ORC-5 “Order Status” will contain the reason for the status change. The reason shall be one of the following:

**Order Status Codes**

Value	Description
CM	Order is completed
DC	Order was discontinued
IP	Order is in progress

*Adapted from the HL7 Standard, version 2.3.1*

2785 **4.3.4.2.2.2 Message Semantics (HL7 v2.5.1)**

The HL7 v2.5.1 Message Semantics implement the Chapter 4 OMG message. Refer to HL7 Standard for general message semantics.

See Section 2.4 of this document for MSH segment definition.

Note: Additional qualifications to the level of specification and HL7 profiling are stated in Section 2.

2790 Required segments are listed below. Other segments are optional.

OMG	General Clinical Order Message	Chapter in HL7 v2.5.1
MSH	Message Header	2
ORC	Common Order	4
TQ1	Timing/Quantity	4

OMG	General Clinical Order Message	Chapter in HL7 v2.5.1
OBR	Observation Request	4

**4.3.4.2.2.1 MSH Segment (HL7 v2.5.1)**

2795 The MSH segment shall be constructed as defined in [ITI TF-2: 3.30.5.1](#) MSH – Header Segment. Additional specifications for actors complying with the IHE Radiology Technical Framework are defined in Section 2.4.

Field MSH-9-Message Type shall have three components. The first component shall have a value of OMG; the second component shall have a value of O19; the third component shall have a value of OMG\_O19.

**4.3.4.2.2.2 ORC Segment (HL7 v2.5.1)**

2800 All of the fields in the ORC segment are optional, except those listed in Table 4.3-11. See Section 4.2.4.1.2.2.4 for the list of all fields of the ORC segment.

**Table 4.3-11: IHE Profile - ORC Segment**

SEQ	LEN	DT	OPT	TBL#	ITEM #	ELEMENT NAME
1	2	ID	R	0119	00215	Order Control
2	22	EI	R		00216	Placer Order Number
3	22	EI	R		00217	Filler Order Number
5	2	ID	R	0038	00219	Order Status
7	200	TQ	X		00221	Quantity/Timing

*Adapted from the HL7 Standard, version 2.5.1*

2805 Deprecated component ORC-7.4-Start Date/Time shall not be populated. The TQ1 segment shall be used to carry the start date and time of the procedure.

When an Order Status Update (control code = SC) message is received at the Order Placer, the element *ORC-5-Order Status* will contain the reason for the status change. The reason shall be one of the following:

**Order Status Codes**

Value	Description
CM	Order is completed
DC	Order was discontinued
IP	Order is in progress

2810

*Adapted from the HL7 Standard, version 2.5.1*

**4.3.4.2.2.3 TQ1 Segment (HL7 v2.5.1)**

Deprecated components ORC-7.4-Start Date/Time or OBR-27.4-Start Date/Time shall not be populated. The TQ1 segment shall be used to carry the start date and time of the procedure.

**Table 4.3-12: IHE Profile – TQ1 Segment**

SEQ	LEN	DT	OPT	TBL#	ITEM #	ELEMENT NAME
1	4	SI	O		01627	Set ID – TQ1
2	20	CQ	O		01628	Quantity
3	540	RPT	O	0335	01629	Repeat Pattern
4	20	TM	O		01630	Explicit Time
5	20	CQ	O		01631	Relative Time and Units
6	20	CQ	O		01632	Service Duration
7	26	TS	R		01633	Start Date/Time
8	26	TS	O		01634	End Date/Time
9	250	CWE	O	0485	01635	Priority
10	250	TX	O		01636	Condition Text
11	250	TX	O	0065	01637	Text Instruction
12	10	ID	C	0427	01638	Conjunction
13	20	CQ	O		01639	Occurrence Duration
14	10	NM	O		01640	Total Occurrences

2815

*Adapted from the HL7 Standard, version 2.5.1*

Field *TQ1-7-Start Date/Time* shall contain the date and time of the exam.

**4.3.4.2.2.4 OBR Segment (HL7 v2.5.1)**

All of the fields in the OBR segment are optional, except those listed in Table 4.3-13. See Section 4.2.4.1.2.2.6 for the list of all fields of the OBR segment.

2820

**Table 4.3-13: IHE Profile - OBR Segment**

SEQ	LEN	DT	OPT	TBL#	ITEM #	ELEMENT NAME
2	22	EI	C		00216	Placer Order Number
3	22	EI	R		00217	Filler Order Number

*Adapted from the HL7 Standard, version 2.5.1*

Deprecated component OBR-27.4-Start Date/Time shall not be populated. The TQ1 segment shall be used to carry the start date and time of the procedure.

#### 4.3.4.2.3 Expected Actions

2825 DSS/Order Filler shall provide Order Placer with status updates on the order. At least the following events shall be noted:

- In Progress – when the first Performed Procedure Step corresponding to the Order has been created;
- Discontinued – when a cancellation request was received from Order Placer, after an Order has been set to “In-Progress”. A discontinuation applied instead.
- Completed – when the complete, verified report is available for the given order.

2835 Order Filler shall send at least one Order Status Update message with the Order Status code of “CM”. Determination of exact timing of such a message shall be at the discretion of the Order Filler; however, it may not occur before the final, verified report for all requested procedures within the order is available.

2840 Order Filler shall use the Order Status Update message with the Order Status code of “IP”, to facilitate synchronization of order handling with the Order Placer, for example, to prevent cancellation/discontinuation of an order in progress. In this case, at least one message shall be sent after the Order Filler/Department System Scheduler has processed the first Modality Procedure Step In Progress [RAD-6] transaction associated with the order. Note, that Order Placer may still issue the cancellation request, for example, because of race condition between two messages. In such case, Order Filler shall process cancellation of the order as a discontinuation and return an Order Status Update message with the Order Status Code of “OD”.

2845 Order Status Update message cannot be used to request an action, for example, cancellation or discontinuation of an order.

If an order is being created by the Order Filler (for example, in a case of unidentified patient, see RAD TF-1: 4.4), the Order Status Update message shall not be issued until New Order message has been sent by the Order Filler.

#### 4.3.4.3 Filler Order Management - Order Cancelled by the Order Filler

##### 2850 4.3.4.3.1 Trigger Events

Actors claiming the HL7 v2.3.1 Message Semantics shall implement the following trigger event:

ORM – Department System Scheduler/Order Filler cancels the order previously received from Order Placer (control code = OC).

Actors claiming the HL7 v2.5.1 Message Semantics shall implement the following trigger event:

2855 OMG – Department System Scheduler/Order Filler cancels the order previously received from Order Placer (control code = OC).

### 4.3.4.3.2 Message Semantics

#### 4.3.4.3.2.1 Message Semantics (HL7 v2.3.1)

2860 HL7 2.3.1 Chapter 4 ORM message. Refer to HL7 standard for general message semantics. Required segments listed below. Other segments are optional.

Note: Additional qualifications to the level of specification and HL7 profiling are stated in Section 2.3.

ORM	General Order Message	Chapter in HL7 2.3.1
MSH	Message Header	2
PID	Patient Identification	3
PV1	Patient Visit	3
ORC	Common Order	4

2865 Each message shall be acknowledged by the HL7 ACK message sent by the receiver of ADT message to its sender. See Section 2.4.3 “Acknowledgement Modes” for definition and discussion of the ACK message.

#### 4.3.4.3.2.1.1 MSH Segment (HL7 v2.3.1)

MSH segment shall be constructed as defined in the Section 2.4.2.2 “Message Control”.

2870 Field *MSH-9 Message Type* shall have at least two components. The first component shall have a value of “ORM”; the second component shall have value of O01. The third component is optional; however, if present, it shall have a value of ORM\_O01.

#### 4.3.4.3.2.1.2 PID Segment (HL7 v2.3.1)

All of the fields in PID segment are optional, except those listed in Table 4.3-14. See Section 4.1.4.1.2.1.3 for the list of all fields of the PID segment.

**Table 4.3-14: IHE Profile - PID segment**

SEQ	LEN	DT	OPT	TBL#	ITEM#	ELEMENT NAME
3	20	CX	R		00106	Patient Identifier List
5	48	XP	R		00108	Patient Name
18	20	CX	C		00121	Patient Account Number

2875

*Adapted from the HL7 standard, version 2.3.1*

#### 4.3.4.3.2.1.3 PV1 Segment (HL7 v2.3.1)

All of the fields in PV1 segment are optional, except those listed in Table 4.3-15. See Section 4.1.4.1.2.1.4 for the list of all fields of the PV1 segment.

**Table 4.3-15: IHE Profile - PV1 Segment**

SEQ	LEN	DT	OPT	TBL#	ITEM#	ELEMENT NAME
2	1	IS	R	0004	00132	Patient Class
19	20	CX	C		00149	Visit Number
51	1	IS	C	0326	01226	Visit Indicator

2880

*Adapted from the HL7 standard, version 2.3.1*

Additional requirements for the presence of value in these fields may be documented in regional or national extensions to the IHE Radiology Technical Framework (see RAD TF-4).

At least one of the fields *PID-18 Patient Account Number* or *PV1-19 Visit Number* shall be valued.

2885

Field *PV1-51 Visit Indicator* shall be valued with value “V” if the field *PV1-19 Visit Number* is present. May be omitted otherwise.

**4.3.4.3.2.1.4 ORC Segment (HL7 v2.3.1)**

All of the fields in ORC segment are optional, except those listed in Table 4.3-16. See Section 4.2.4.1.2.1.4 for the list of all fields of the ORC segment.

2890

**Table 4.3-16: IHE Profile - ORC Segment**

SEQ	LEN	DT	OPT	TBL#	ITEM #	ELEMENT NAME
1	2	ID	R	0119	00215	Order Control
2	22	EI	R		00216	Placer Order Number
3	22	EI	R		00217	Filler Order Number

*Adapted from the HL7 Standard, version 2.3.1*

The action to be performed in the ORM message is defined by the Order Control code passed as part of the message. The order control code below shall be supported.

**Table 4.3-17: IHE Profile - Supported Order Control Codes**

Value	Description	Originator
OC	Order Cancelled	F

2895

**4.3.4.3.2.2 Message Semantics (HL7 v2.5.1)**

The HL7 v2.5.1 Message Semantics implement the OMG message. Refer to the HL7 standard for general message semantics. Required segments are listed below. Other segments are optional.

Note: Additional qualifications to the level of specification and HL7 profiling are stated in Section 2.3.

2900

OMG	General Clinical Order Message	Chapter in HL7 v2.5.1
MSH	Message Header	2
PID	Patient Identification	3
PV1	Patient Visit	3
ORC	Common Order	4
OBR	Order Detail	4

Each message shall be acknowledged by the HL7 ACK message sent by the receiver of the OMG message to its sender. See Section 2.4 for definition and discussion of the ACK message.

**4.3.4.3.2.1 MSH Segment (HL7 v2.5.1)**

2905 The MSH segment shall be constructed as defined in [ITI TF-2: 3.30.5.1](#) MSH – Header Segment. Additional specifications for actors complying with the IHE Radiology Technical Framework are defined in Section 2.4.

Field *MSH-9-Message Type* shall have three components. The first component shall have a value of OMG; the second component shall have a value of O19; the third component shall have a value of OMG\_O19.

2910 **4.3.4.3.2.2 PID Segment (HL7 v2.5.1)**

All of the fields in the PID segment are optional, except those listed in Table 4.3-18. See Section 4.1.4.1.2.2.3 for further discussion of the PID segment.

**Table 4.3-18: IHE Profile - PID segment**

SEQ	LEN	DT	OPT	TBL#	ITEM#	ELEMENT NAME
3	250	CX	R		00106	Patient Identifier List
5	250	XPN	R		00108	Patient Name
18	250	CX	C		00121	Patient Account Number

*Adapted from the HL7 standard, version 2.5.1*

2915 **4.3.4.3.2.3 PV1 Segment (HL7 v2.5.1)**

All of the fields in the PV1 segment are optional, except those listed in Table 4.3-19. See Section 4.1.4.1.2.2.4 for a full discussion of the PV1 segment.

**Table 4.3-19: IHE Profile - PV1 Segment**

SEQ	LEN	DT	OPT	TBL#	ITEM#	ELEMENT NAME
2	1	IS	R	0004	00132	Patient Class
19	250	CX	C		00149	Visit Number
51	1	IS	C	0326	01226	Visit Indicator

*Adapted from the HL7 standard, version 2.5.1*



2920 Additional requirements for the presence of value in these fields may be documented in regional or national extensions to the IHE Radiology Technical Framework (see RAD TF-4).

At least one of the fields *PID-18-Patient Account Number* or *PV1-19-Visit Number* shall be valued.

2925 Field *PV1-51-Visit Indicator* shall be valued with value “V” if the field *PV1-19 Visit Number* is valued. It may be omitted otherwise.

**4.3.4.3.2.2.4 ORC Segment (HL7 v2.5.1)**

All of the fields in the ORC segment are optional, except those listed in Table 4.3-20. See Section 4.2.4.1.2.2.4 for the list of all fields of the ORC segment.

**Table 4.3-20: IHE Profile - ORC Segment**

SEQ	LEN	DT	OPT	TBL#	ITEM #	ELEMENT NAME
1	2	ID	R	0119	00215	Order Control
2	22	EI	R		00216	Placer Order Number
3	22	EI	R		00217	Filler Order Number

2930

*Adapted from the HL7 Standard, version 2.5.1*

The action to be performed in the OMG message is defined by the Order Control code passed as part of the message. The order control code below shall be supported.

**Table 4.3-21: IHE Profile - Supported Order Control Codes**

Value	Description	Originator
OC	Order Cancelled	F

**4.3.4.3.2.2.5 OBR Segment (HL7 v2.5.1)**

2935 All of the fields in the OBR segment are optional, except those listed in Table 4.3-22. See Section 4.2.4.1.2.2.6 for the list of all fields of the OBR segment.

**Table 4.3-22: IHE Profile - OBR Segment**

SEQ	LEN	DT	OPT	TBL#	ITEM #	ELEMENT NAME
2	22	EI	C		00216	Placer Order Number
3	22	EI	R		00217	Filler Order Number

*Adapted from the HL7 Standard, version 2.5.1*

#### **4.3.4.3.3 Expected Actions**

2940 After receiving the ORM message (or OMG message if implementing the HL7 v2.5.1 Message Semantics) with the control code OC, Order Placer shall process the order the same way as if it was cancelled/discontinued by the Order Placer.

2945 If DSS/Order Filler has already scheduled the procedures corresponding to the order, it shall perform transaction Procedure Update [RAD-13] (see Section 4.13) to notify the Image Manager of order cancellation.

## 4.4 Procedure Scheduled [RAD-4]

### 4.4.1 Scope

2950 This transaction specifies a message from the Department System Scheduler/Order Filler to the Image Manager and the Report Manager notifying them that a procedure has been scheduled.

Scheduling does not necessarily mean precise time assignment for the particular procedures. For example, inpatient procedures are not necessarily scheduled for a specific time slot, but rather for “today” or “as soon as possible”. However, the Department System Scheduler/Order Filler shall handle all orders in such a way that it is capable of informing the Image Manager and the Report  
2955 Manager about procedure timing and resources used to perform a procedure. It must provide the date and time when the procedure is to be performed, although precision of the time portion of that information is allowed to be implementation dependent.

This message serves as a trigger event for the Image Manager and the Report Manager, informing it to obtain necessary information and apply rules to ensure the availability of relevant  
2960 information to the end user. The Image Manager and the Report Manager may need the information to create the Requested Procedure context for its purposes. The Procedure Scheduled transaction includes the initial scheduling message. The Procedure Scheduled message is also used to provide additional information from the Department System Scheduler to the Image  
2965 Manager and the Report Manager for unscheduled cases. In the event that a procedure is performed prior to ordering (as in some of the use cases in RAD TF-1: 4.4 for SWF and in RAD TF-1: 34.4.2 for SWF.b), this message is used “after the fact” for the Department System Schedule to inform the Image Manager and the Report Manager of critical information such as Accession Number and Requested Procedure ID. This is described in more detail within this section.

2970 The Department System Scheduler/Order Filler will need to communicate with multiple Image Managers. The Department System Scheduler/Order Filler shall broadcast these scheduling messages to all Image Managers and the Report Manager. An Image Manager shall be able to receive and process these messages with the understanding that the images and MPPS events for these procedures may be sent to a different Image Manager.

2975 The organization operating the DSS/OF and the Image Manager/Image Archive is responsible for synchronizing Procedure and Protocol Codes between all the systems that use such codes. IHE does not yet define a common mechanism for code synchronization or access.

### 4.4.2 Actor Roles

**Actor:** Department System Scheduler/Order Filler

2980 **Role:** Enters, modifies and stores information about patients, receives orders, schedules Procedures (exams), modifies information about them (rescheduling, cancellations, code changes, etc.).

**Actor:** Image Manager

2985 **Role:** Receives information about Patients, Orders, and schedules, and uses this information to assist in image management.

**Actor:** Report Manager

**Role:** Receives information about Patients, Orders, and schedules, and uses this information to assist in Report management.

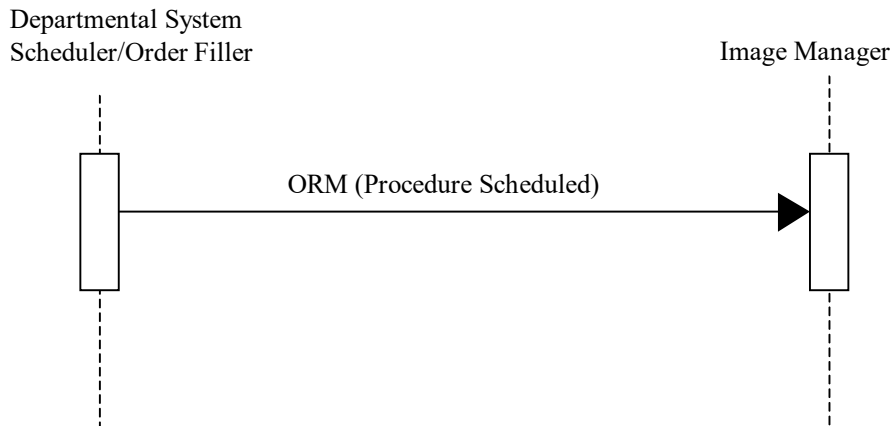
#### 4.4.3 Referenced Standards

2990 HL7 v2.3.1 Chapters 2-4

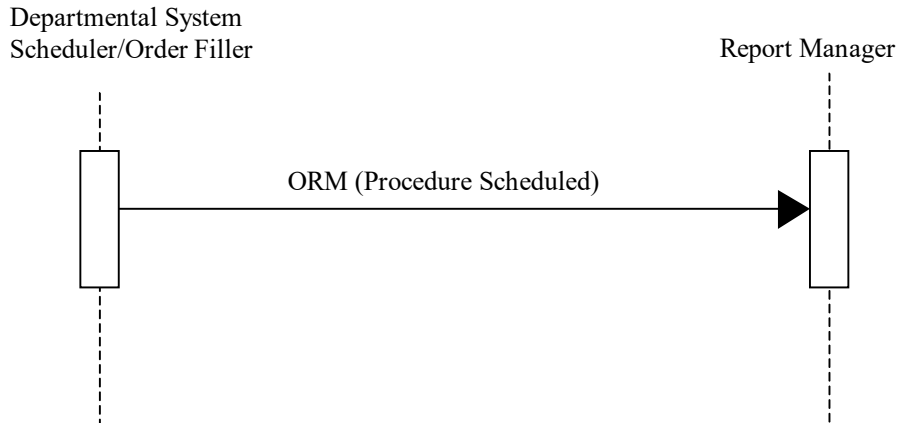
HL7 v2.5.1 Chapters 2-4

#### 4.4.4 Messages

The following diagram illustrates interactions between actors within systems implementing HL7 v2.3.1:

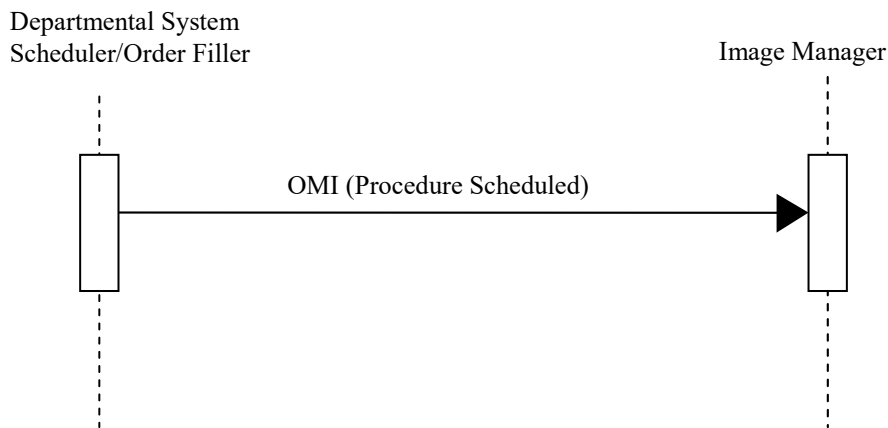


2995

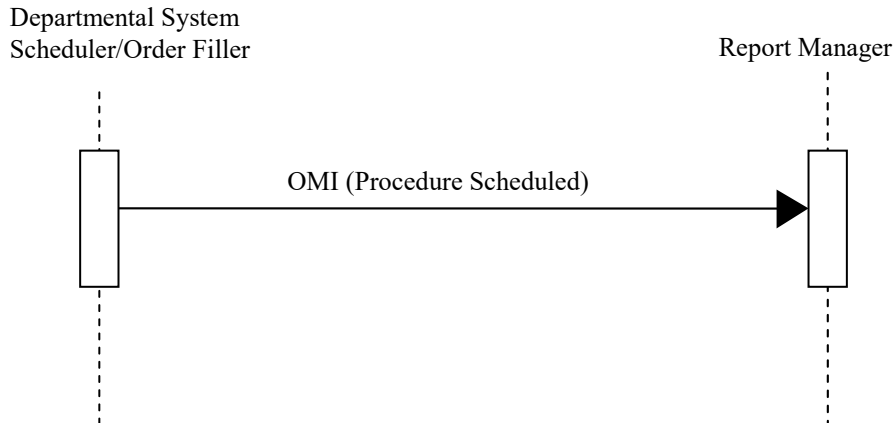


**Figure 4.4.4-1: Interactions between actors implementing HL7 v2.3.1**

The following diagram illustrates interactions between actors within systems implementing HL7 v2.5.1:



3000



**Figure 4.4.4-2: Interactions between actors implementing HL7 v2.5.1**

#### 4.4.4.1 Procedure Scheduled Message

##### 4.4.4.1.1 Trigger Events

3005 The Department System Scheduler/Order Filler determines procedures which need to be performed to fill the order, what Procedure Steps need to be performed for each Procedure, and timing and necessary resources.

Note: This transaction shall be used the first time a particular Study Instance UID is sent from the Department System Scheduler/Order Filler to the Image Manager or Report Manager. If the Study Instance UID has been sent previously, then Procedure Updated [RAD-13] shall be used.

3010

##### 4.4.4.1.2 Message Semantics

Message semantics are defined for both HL7 v2.3.1 and HL7 v2.5.1. The Profile and/or Options being claimed that incorporate this transaction will specify whether actors are required to support one, the other, or both sets of semantics.

##### 3015 4.4.4.1.2.1 Message Semantics (HL7 v2.3.1)

The Department System Scheduler/Order Filler uses an ORM message to convey necessary procedure and scheduling information.

3020

The Procedure Scheduled Transaction will perform the additional task of providing Patient Demographic information to the Image Manager and the Report Manager. The Image Manager and the Report Manager do not receive all Patient Registration events from the ADT System because it is not necessary for the Image Manager and Report Manager to be aware of all patients in the enterprise (since most will never have an imaging procedure). The Image Manager and the Report Manager shall obtain the Patient Demographic information from the Procedure Schedule ORM, specifically the PID and PV1 segments. For this reason, the Department System

3025 Scheduler/Order Filler must complete these segments as described in Section 4.1, Patient Registration.

Note: Additional information regarding HL7 conventions, profiling, and implementation considerations is given in Section 2.3.

The segments listed below are required. All other segments are optional.

3030

ORM	General Order Message	Chapter in HL7 2.3
MSH	Message Header	2
PID	Patient Identification	3
PV1	Patient Visit	3
{ORC	Common Order	4
OBR}	Order Detail	4
ZDS	Additional identification information (custom for IHE)	

Each message shall be acknowledged by the HL7 ACK message sent by the receiver of the ORM message to its sender. See Section 2.4.3 “Acknowledgement Modes” for definition and discussion of the ACK message.

**4.4.4.1.2.1.1 MSH Segment (HL7 v2.3.1)**

3035 MSH segment shall be constructed as defined in the Section 2.4.2.2 “Message Control”.

Field *MSH-9 Message Type* shall have at least two components. The first component shall have a value of “ORM”; the second component shall have value of O01. The third component is optional; however, if present, it shall have a value of ORM\_O01.

**4.4.4.1.2.1.2 PID Segment (HL7 v2.3.1)**

3040 See Section 4.1.4.1.2.1.3 for the specification of the PID segment.

**4.4.4.1.2.1.3 PV1 Segment (HL7 v2.3.1)**

All of the fields in PV1 segment are optional, except those listed in Table 4.4-2. See Section 4.1.4.1.2.1.4 for the list of all fields of the PV1 segment.

**Table 4.4-2: IHE Profile - PV1 Segment**

SEQ	LEN	DT	OPT	TBL#	ITEM#	ELEMENT NAME
2	1	IS	R	0004	00132	Patient Class
3	80	PL	C		00133	Assigned Patient Location
7	60	XCN	C	0010	00137	Attending Doctor
8	60	XCN	C	0010	00138	Referring Doctor
9	60	XCN	R2	0010	00139	Consulting Doctor
10	3	IS	C	0069	00140	Hospital Service

SEQ	LEN	DT	OPT	TBL#	ITEM#	ELEMENT NAME
15	2	IS	C	0009	00145	Ambulatory Status
17	60	XCN	C	0010	00147	Admitting Doctor
19	20	CX	C		00149	Visit Number
51	1	IS	C	0326	01226	Visit Indicator

3045

*Adapted from the HL7 standard, version 2.3.1*

Additional requirements for the presence of value in these fields may be documented in regional or national extensions to the IHE Radiology Technical Framework (see RAD TF-4).

3050

Fields *PV1-3 Assigned Patient Location*, *PV1-7 Attending Doctor*, *PV1-10 Hospital Service*, *PV1-17 Admitting Doctor* shall be valued only when a procedure is scheduled for the admitted in-patient.

Field *PV1-8 Referring Doctor* shall be valued when a procedure is scheduled for an outpatient. May be omitted otherwise.

Field *PV1-15 Ambulatory Status* shall be valued when patient status indicates certain conditions such as pregnancy. May be omitted if none of the defined statuses are applicable to a patient.

3055

At least one of the fields *PID-18 Patient Account Number* or *PV1-19 Visit Number* shall be valued.

Field *PV1-51 Visit Indicator* shall be valued with value “V” if the field *PV1-19 Visit Number* is present. May be omitted otherwise.

#### 4.4.4.1.2.1.4 ORC Segment (HL7 v2.3.1)

3060

All of the fields in ORC segment are optional, except those listed in Table 4.4-3. See Section 4.2.4.1.2.1.4 for the list of all fields of the ORC segment

**Table 4.4-3: IHE Profile - ORC Segment**

SEQ	LEN	DT	OPT	TBL#	ITEM #	ELEMENT NAME
1	2	ID	R	0119	00215	Order Control
2	22	EI	R2		00216	Placer Order Number
3	22	EI	R		00217	Filler Order Number
5	2	ID	R	0038	00219	Order Status
7	200	TQ	R		00221	Quantity/Timing
10	120	XCN	R2		00224	Entered By
12	120	XCN	R2		00226	Ordering Provider
13	80	PL	R2		00227	Enterer’s Location
14	40	XTN	R2		00228	Call Back Phone Number
17	60	CE	R2		00231	Entering Organization

*Adapted from the HL7 Standard, version 2.3.1*



3065 The Department System Scheduler uses the ORM message in a context different from the context existing between Order Placer and Order Filler. The Department System Scheduler/Order Filler shall send as many ORM messages as there are Requested Procedures identified to fill a single order. Each ORM message shall contain as many ORC/OBR pairs as there are Protocol Codes in all Scheduled Procedure Steps for that Requested Procedure.

3070 It is actually common for the Department System Scheduler/Order Filler to receive a single ORM from the Order Placer system, but choose to expand that order into multiple Requested Procedures, therefore sending multiple ORMs to the Image Manager or Report Manager. Taking this into account, the Department System Scheduler will consider itself an “order placer” in relation to the Image Manager or Report Manager.

3075 Required fields in the ORC segment shall be filled by the Department System Scheduler as given in the following table.

**Table 4.4-4: DSS Mappings of the ORC Segment**

Element Name	Seq.	Element Shall Contain:	Notes
Order Control Code	ORC-1	“NW”	New order
Placer Order Number	ORC-2	Placer Order Number received from Order Placer	In the event that the Order Filler places the order, the Order Filler shall not send the scheduling ORM message until it has received the Placer Order Number from the Order Placer (through an ORR message). If the Order Filler schedules a procedure for unidentified patient without an order (see case 4), this field shall be empty.
Filler Order Number	ORC-3	Filler Order Number	Number generated internally by the Department System Scheduler
Order Status	ORC-5	“SC”	Scheduled
Quantity/Timing	ORC-7	Date and time of the Scheduled Procedure Step (in the fourth component)	

**4.4.4.1.2.1.5 OBR Segment (HL7 v2.3.1)**

All of the fields in OBR segment are optional, except those listed in Table 4.4-5. See Section 4.2.4.1.2.1.5 for the list of all fields of the OBR segment.

3080

**Table 4.4-5: IHE Profile - OBR Segment**

SEQ	LEN	DT	OPT	TBL#	ITEM #	ELEMENT NAME
1	4	SI	R		00237	Set ID – OBR
2	22	EI	R2		00216	Placer Order Number
3	22	EI	R		00217	Filler Order Number

SEQ	LEN	DT	OPT	TBL#	ITEM #	ELEMENT NAME
4	200	CE	R		00238	Universal Service ID
5	2	ID	R2		00239	Priority
12	60	CE	R2		00246	Danger Code
13	300	ST	R2		00247	Relevant Clinical Info.
15	300	CM	C	0070	00249	Specimen Source
16	120	XCN	R2		00226	Ordering Provider
17	40	XTN	R2		00250	Order Callback Phone Number
18	60	ST	R		00251	Placer field 1
19	60	ST	R		00252	Placer field 2
20	60	ST	R		00253	Filler Field 1
24	10	ID	R	0074	00257	Diagnostic Serv Sect ID
27	200	TQ	R		00221	Quantity/Timing
30	20	ID	R2	0124	00262	Transportation Mode
31	300	CE	R2		00263	Reason for Study
44	80	CE	O	0088	00393	Procedure Code

*Adapted from the HL7 Standard, version 2.3.1*

3085

Field *OBR-15 Specimen Source* holds the laterality (Left/Right) indicator (when used) in the <site modifier (CE)> component. This element shall be present if the procedure has laterality and the Universal Service ID code in *OBR-4* does not encode laterality. This element shall not be present otherwise.

Per the HL7 Standard, IHE recommends that some fields in ORC and OBR segments contain the same information, as described in Section 4.2.4.1.2.1.5.

Required fields in the OBR segment that are not identical to those from the ORC segment shall be filled by the Department System Scheduler as defined in the following table.

3090

**Table 4.4-6: DSS mappings of the OBR Segment**

Element Name	Seq.	Shall Contain:	Notes
Placer Field 1	OBR-18	Accession Number	Length of the value in this field shall not exceed 16 characters
Placer Field 2	OBR-19	Requested Procedure ID	All OBR segments within a single ORM message shall have the same value in this field.
Filler Field 1	OBR-20	Scheduled Procedure Step ID	If a Scheduled Procedure Step has multiple Protocol Codes associated with it, several ORC segments within a single ORM message may have the same value in this field.
Universal Service ID	OBR-4	Both the Universal Service ID of the Order and a Scheduled Protocol Code of the Scheduled Procedure Step (see OBR-20).	Components 1-3 of OBR-4 shall be copied by the Order Filler from the components 1-3 of OBR-4 it obtains from the ORM message (OBR segment) conveyed to it by the Order Placer. Components 1-3 of OBR-4 in all OBR segments of an ORM message shall have the same value. Components 4-6 shall be filled with the Scheduled Protocol Code. (See Section 4.4.4.1.2.1.4 for multiple Scheduled Protocol Codes.) The related Requested Procedure Code/Description is sent in OBR-44.
Specimen Source	OBR-15	Laterality of the procedure. The value shall be appended to the Requested Procedure Description (0032,1060).	See note below Table 4.4-5.
Diagnostic Service Section ID	OBR-24	DICOM Modality	The Modality attribute of DICOM consists of Defined Terms that shall be used in this element.
Procedure Code	OBR-44	Requested Procedure Code and Requested Procedure Description.	Components 1-3 shall contain the Requested Procedure Code for this ORM message. Optionally, component 5 may contain the Requested Procedure Description. As the Order Filler may expand a single order into multiple Requested Procedures, multiple ORM messages may be sent for a single Order (with the same value for Components 1-3 of OBR-4).

A custom ZDS Segment is defined to convey information generated by the Order Filler and not currently defined in the HL7 standard and is given in the following table.

3095

**Table 4.4-7: IHE Profile - ZDS Segment**

SEQ	LEN	DT	OPT	TBL#	ITEM#	ELEMENT NAME
1	200	RP	R		Z0001	Study Instance UID

Components of the Study Instance UID field shall be encoded as given in the Table 4.4-8.

**Table 4.4-8: Z Segment Study Instance UID Element Components**

Component Number	Component Name	Shall Contain:
1	Reference Pointer	DICOM compliant Study Instance UID value

Component Number	Component Name	Shall Contain:
2	Application ID	Implementation specific
3	Type of Data	“Application”
4	Subtype	“DICOM”

#### 4.4.4.1.2 Message Semantics (HL7 v2.5.1)

3100 The HL7 2.5.1 Message Semantics implement the OMI message. Refer to the HL7 Standard for general message semantics. This section contains additional requirements for the OMI message.

The Department System Scheduler/Order Filler uses an OMI message to convey necessary procedure and scheduling information.

3105 The Procedure Scheduled Transaction will perform the additional task of providing Patient Demographic information to the Image Manager and the Report Manager. The Image Manager and the Report Manager do not receive all Patient Registration events from the ADT System because it is not necessary for the Image Manager and Report Manager to be aware of all patients in the enterprise (since most will never have an imaging procedure). The Image Manager and the Report Manager shall obtain the Patient Demographic information from the Procedure Scheduled OMI message, specifically the PID and, PV1 segments. For this reason, the  
3110 Department System Scheduler/Order Filler must complete these segments as described in Section 4.1, Patient Registration.

Note: Additional information regarding HL7 conventions, profiling, and implementation considerations is given in Section 2.3.

3115 The segments listed below are required or conditionally required. All other segments are optional.

Segment	Meaning	Usage	Card.	HL7 chapter
MSH	Message Header	R	[1..1]	2
PID	Patient Identification	R	[1..1]	3
PV1	Patient Visit	R	[1..1]	3
AL1	Allergy Information	C	[0..*]	3
ORC	Common Order	R	[1..*]	4
TQ1	Timing/Quantity	R	[1..1]	4
OBR	Order Detail	R	[1..1]	4
OBX	Observation/Result	C	[0..*]	7
IPC	Imaging Procedure Control	R	[1..*]	4

The allergy segment AL1 shall be present if allergy information is added/updated. The OBX segment(s) shall be present if patient weight and/or height is updated.

3120 Each message shall be acknowledged by the HL7 ACK message sent by the receiver of the ORM message to its sender. See Section 2.4.4.3 “Acknowledgement Modes” for definition and discussion of the ACK message.

**4.4.4.1.2.2.1 MSH Segment (HL7 v2.5.1)**

The MSH segment shall be constructed as defined in [ITI TF-2: 3.30.5.1 MSH – Header Segment](#). Additional specifications for actors complying with the IHE Radiology Technical Framework are in Section 2.4.

- 3125 Field MSH-9-Message Type shall have three components. The first component shall have a value of OMI; the second component shall have a value of O23; the third component shall have a value of OMI\_O23.

**4.4.4.1.2.2.2 PID Segment (HL7 v2.5.1)**

See Section 4.1.4.1.2.2.3 for the specification of the PID segment.

3130 **4.4.4.1.2.2.3 PV1 Segment (HL7 v2.5.1)**

All of the fields in the PV1 segment are optional, except those listed in Table 4.4-10. See Section 4.1.4.1.2.2.4 for a full discussion of the PV1 segment.

**Table 4.4-10: IHE Profile - PV1 Segment**

SEQ	LEN	DT	OPT	TBL#	ITEM#	ELEMENT NAME
2	1	IS	R	0004	00132	Patient Class
3	80	PL	C		00133	Assigned Patient Location
7	60	XCN	C	0010	00137	Attending Doctor
8	60	XCN	C	0010	00138	Referring Doctor
9	60	XCN	X	0010	00139	Consulting Doctor
10	3	IS	C	0069	00140	Hospital Service
15	2	IS	C	0009	00145	Ambulatory Status
17	60	XCN	C	0010	00147	Admitting Doctor
19	20	CX	C		00149	Visit Number
51	1	IS	C	0326	01226	Visit Indicator

*Adapted from the HL7 standard, version 2.5.1*

- 3135 Additional requirements for the presence of value in these fields may be documented in regional or national extensions to the IHE Radiology Technical Framework (see RAD TF-4).  
Fields *PV1-3-Assigned Patient Location*, *PV1-7-Attending Doctor*, *PV1-10-Hospital Service*, *PV1-17-Admitting Doctor* shall be valued only when a procedure is scheduled for an admitted in-patient.
- 3140 Field *PV1-8-Referring Doctor* shall be valued when registering an outpatient (*MSH-9- Message Type* is ADT^A04^ADT\_A01) or when pre-registering a patient (*MSH-9-Message Type* is ADT^A05^ADT\_A05).  
Field *PV1-9-Consulting Doctor* shall not be present.

3145 Field *PV1-15-Ambulatory Status* shall be valued when patient status indicates certain conditions such as pregnancy. It may be omitted if none of the defined statuses are applicable to a patient.

At least one of the fields *PID-18-Patient Account Number* or *PV1-19-Visit Number* shall be valued.

Field *PV1-51-Visit Indicator* shall be valued with value “V” if the field *PV1-19-Visit Number* is valued. It may be omitted otherwise.

3150 **4.4.4.1.2.2.4 Intentionally Left Blank**

**4.4.4.1.2.2.5 ORC Segment (HL7 v2.5.1)**

All of the fields in the ORC segment are optional, except those listed in Table 4.4-11. See Section 4.2.4.1.2.2.4 for the list of all fields of the ORC segment.

**Table 4.4-11: IHE Profile - ORC Segment**

SEQ	LEN	DT	OPT	TBL#	ITEM #	ELEMENT NAME
1	2	ID	R	0119	00215	Order Control
2	22	EI	R2		00216	Placer Order Number
3	22	EI	R		00217	Filler Order Number
5	2	ID	R	0038	00219	Order Status
7	200	TQ	X		00221	Quantity/Timing
10	250	XCN	R2		00224	Entered By
12	250	XCN	R2		00226	Ordering Provider
13	80	PL	R2		00227	Enterer’s Location
14	250	XTN	R2		00228	Call Back Phone Number
17	250	CE	R2		00231	Entering Organization

3155 *Adapted from the HL7 Standard, version 2.5.1*

The Department System Scheduler uses the OMI message in a context different from the context existing between Order Placer and Order Filler. The Department System Scheduler/Order Filler shall send as many OMI messages as there are Requested Procedures identified to fill a single order.

3160 It is actually common for the Department System Scheduler/Order Filler to receive a single ORM from the Order Placer system, but choose to expand that order into multiple Requested Procedures, therefore sending multiple OMIs to the Image Manager or Report Manager. Taking this into account, the Department System Scheduler will consider itself an “order placer” in relation to the Image Manager or Report Manager.

3165 Required fields in the ORC segment shall be filled by the Department System Scheduler as given in the following table.

**Table 4.4-12: DSS Mappings of the ORC Segment**

Element Name	Seq.	Element Shall Contain:	Notes
Order Control Code	ORC-1	“NW”	New order
Placer Order Number	ORC-2	Placer Order Number received from Order Placer	In the event that the Order Filler places the order, the Order Filler shall not send the scheduling OMI message until it has received the Placer Order Number from the Order Placer (through an ORG message). If the Order Filler schedules a procedure for unidentified patient without an order (see case 4), this field shall be empty.
Filler Order Number	ORC-3	Filler Order Number	Number generated internally by the Department System Scheduler
Order Status	ORC-5	“SC”	Scheduled
Quantity/Timing	ORC-7	Shall not be valued: Date and time of the Scheduled Procedure Step shall be carried in the immediately following TQ1 segment.	

**4.4.4.1.2.2.6 TQ1 Segment (HL7 v2.5.1)**

3170

Deprecated components ORC-7.4-Start Date/Time or OBR-27.4-Start Date/Time shall not be populated but instead the TQ1 segment shall be used to carry the start date and time of the procedure.

**Table 4.4-13: IHE Profile – TQ1 Segment**

SEQ	LEN	DT	OPT	TBL#	ITEM #	ELEMENT NAME
1	4	SI	O		01627	Set ID – TQ1
2	20	CQ	O		01628	Quantity
3	540	RPT	O	0335	01629	Repeat Pattern
4	20	TM	O		01630	Explicit Time
5	20	CQ	O		01631	Relative Time and Units
6	20	CQ	O		01632	Service Duration
7	26	TS	R		01633	Start Date/Time
8	26	TS	O		01634	End Date/Time
9	250	CWE	O	0485	01635	Priority
10	250	TX	O		01636	Condition Text
11	250	TX	O	0065	01637	Text Instruction
12	10	ID	C	0427	01638	Conjunction
13	20	CQ	O		01639	Occurrence Duration

SEQ	LEN	DT	OPT	TBL#	ITEM #	ELEMENT NAME
14	10	NM	O		01640	Total Occurrences

*Adapted from the HL7 Standard, version 2.5.1*

Field *TQ1-7-Start Date/Time* shall contain the date and time of the exam.

3175 **4.4.4.1.2.2.7 OBR Segment (HL7 v2.5.1)**

All of the fields in the OBR segment are optional, except those listed in Table 4.4-14. See Section 4.2.4.1.2.2.6 for the list of all fields of the OBR segment.

**Table 4.4-14: IHE Profile - OBR Segment**

SEQ	LEN	DT	OPT	TBL#	ITEM#	ELEMENT NAME
1	4	SI	R		00237	Set ID – OBR
2	22	EI	R2		00216	Placer Order Number
3	22	EI	R		00217	Filler Order Number
4	200	CE	R		00238	Universal Service ID
5	2	ID	R2		00239	Priority
12	60	CE	R2		00246	Danger Code
13	300	ST	R2		00247	Relevant Clinical Info.
16	120	XCN	R2		00226	Ordering Provider
17	40	XTN	R2		00250	Order Callback Phone Number
27	200	TQ	X		00221	Quantity/Timing
30	20	ID	R2	0124	00262	Transportation Mode
31	300	CE	R2		00263	Reason for Study
46	250	CE	R2	0411	01474	Placer Supplemental Service Information

*Adapted from the HL7 Standard, version 2.5.1*

3180 One ORC-TQ1-OBR-IPC segment group shall correspond to each Requested Procedure. If a Requested Procedure is comprised of multiple Scheduled Procedure Steps and/or if a Scheduled Procedure Step is comprised of multiple Protocol Codes, each applicable Scheduled Procedure Step / Protocol Code combination shall be included in a separate IPC segment following the ORC-TQ1-OBR segment group that contains the Requested Procedure.

3185 • Field OBR-46-Placer Supplemental Service Information holds the laterality (Left/Right) indicator (when used). This element shall be populated if the procedure has laterality and the Universal Service ID code in OBR-4 does not encode laterality. This element shall be empty otherwise. Field OBR-15-Specimen Source, which had formerly been adapted for this use by the IHE Technical Framework and has been deprecated in HL7 Version 2.5.1, shall not be present. See RAD TF-2x: Appendix B for details.

3190 • Per the HL7 Standard, IHE recommends that some fields in the ORC and OBR segments contain the same information, as described in Section 4.2.4.1.2.6.6.



3195

- Non-optional fields in the OBR segment that are not identical to those from the ORC segment shall be filled by the Department System Scheduler as defined in the following table.

**Table 4.4-15: DSS mappings of the OBR Segment**

Element Name	Seq.	Shall Contain:	Notes
Universal Service ID	OBR-4	The Universal Service ID of the Order.	Components 1-3 of OBR-4 shall be copied by the Order Filler from the components 1-3 of OBR-4 it obtains from the ORM message (OBR segment) conveyed to it by the Order Placer. Components 1-3 of OBR-4 in all OBR segments of an OMI or legacy ORM message shall have the same value. The related Requested Procedure Code/Description are sent in OBR-44. As the Order Filler may expand a single order into multiple Requested Procedures, multiple OMI messages may be sent for a single Order (with the same value for Components 1-3 of OBR-4).
Reason for Study	OBR-31	The reason or clinical indication for which the study was ordered.	Components 1-3 of OBR-31 shall be copied by the Order Filler from the components 1-3 of OBR-31 it obtains from the ORM message (OBR segment) conveyed to it by the Order Placer. Component 5 (Alternate Text) shall be copied from the Component 5 of the OBR-31 conveyed by the Order Placer if present. Otherwise, the value of Component 5 may be generated by the DSS/Order Filler. Components 2 and 5 may or may not have the same value. Procedure codes may have both short and long names, either may be used in either component. As the Order Filler may expand a single order into multiple Requested Procedures, multiple OMI messages may be sent for a single Order (with the same value for Components 1-3 and 5 of OBR-31).
Procedure Code	OBR-44	Requested Procedure Code and Requested Procedure Description.	Components 1-3 shall contain the Requested Procedure Code for this OMI message. Optionally, component 5 may contain the Requested Procedure Description.
Placer Supplemental Service Information	OBR-46	Laterality of the procedure. The value shall be appended to the Requested Procedure Description (0032,1060).	See note below Table 4.4-14.

**4.4.4.1.2.2.8 IPC Segment (HL7 v2.5.1)**

All of the fields in the IPC segment are optional, except those listed in Table 4.4-16.

3200

**Table 4.4-16: IHE Profile –IPC Segment**

SEQ	LEN	DT	OPT	TBL#	ITEM#	ELEMENT NAME
1	80	EI	R		00237	Accession Identifier
2	22	EI	R		00216	Requested Procedure ID
3	70	EI	R		00217	Study Instance UID
4	22	EI	R		00238	Scheduled Procedure Step ID
5	16	CE	R+		00239	Modality
6	250	CE	R2		00246	Protocol Code

*Adapted from the HL7 Standard, version 2.5.1*

The Department System Scheduler uses the OMI message in a context different from the context of the ORM message sent between the Order Placer and Order Filler. As provided by the HL7 Standard, each OMI message shall convey information about Requested Procedure(s) pertaining to one order.

3205

The value of the IPC-1 field shall be identical in all IPC segments. Because the Accession Identifier is later mapped to Accession Number (0008,0050), which has a DICOM value representation of Short Text, the length of the value in IPC-1 shall not exceed 16 characters. See the HL7 Standard for further explanation of the use of the IPC segment within the OMI message.

**4.4.4.1.2.2.9 Enterprise Identity Option**

3210

A DSS/Order Filler supporting the Enterprise Identity Option shall send Assigning Authority values for the Patient Identifier and for the Accession Number sent in the OMI message.

The DSS/OF shall provide a value for the Patient Identifier Assigning authority in PID-3.

The DSS/Order Filler shall specify the Assigning Authority of the Accession Number in IPC-1.

3215 It shall provide values for all components of the Accession Identifier. The second component (namespace ID) shall reference the same entity as is referenced by the third and fourth components (universal ID and universal ID type).

**Table 4.4-17: DSS/Order Filler requirements for the IPC Segment for Enterprise Identity Option**

Element Name	Seq.	Shall Contain:	Notes
Accession Identifier	IPC-1	Accession Number and its assigning authority	Values shall be provided for all components: <entity identifier (ST)> ^ <namespace ID (IS)> ^ <universal ID (ST)> ^ <universal ID type (ID)>

3220 For example, a DSS/Order Filler at the Metropolitan Medical Center sends an Image Manager/Archive the following values in a Procedure Scheduled OMI message:

**Table 4.4-18: Example Accession Number Assigning Authority in OMI Message**

Element Name	Seq.	Value
Filler Order Number	OBR-3	35732^99MMC^1.2.mm.nnnnn.444.888888^ISO
Accession Identifier	IPC-1	A35732-1^99MMC^1.2.mm.nnnnn.444.888888^ISO

3225 Typically, the Accession Identifier value in IPC-1 will be the same value as the entity identifier value of the Filler Order Number in OBR-3; however, in this example they are not. Regardless, the same Assigning Authority is providing both of these values so the Image Manager/Archive shall still obtain the Accession Number Assigning Authority from OBR-3 or IPC-1. So, in this example, the Image Manager would map the following values to their corresponding DICOM attributes:

**Table 4.4-19: Example Mapping to DICOM Accession Number Attributes**

DICOM Attribute	DICOM Tag	Value
Accession Number	(0008,0050)	A35732-1
Issuer of Accession Number Sequence	(0008,0051)	
>Local Namespace Entity ID	(0040,0031)	99MMC
>Universal Entity ID	(0040,0032)	1.2.mm.nnnnn.444.888888
>Universal Entity ID Type	(0040,0033)	ISO

3230

#### 4.4.4.2 Expected Actions

##### 4.4.4.2.1 Use Cases

The intent of this section is to illustrate through use cases how key information is used in a Procedure Scheduled transaction.

3235 See RAD TF-1: 3.3 (Typical Process Flow) for illustrations of the following discussions:

- RAD TF-1: 3.3.2.1: In the case where the patient demographics are updated or patients are merged prior to placer order creation, this transaction occurs normally using the updated patient and visit information.
  - RAD TF-1: 3.3.2.2: In the case where the patient demographics are updated or patients are merged after a procedure has been scheduled, only a Patient Update transaction is required, and this transaction is not used.
  - RAD TF-1: 3.3.3: In the case where an order is cancelled at the Order Placer or Order Filler and a new order is generated, the previously scheduled order transaction sent to the Image Manager or Report Manager shall be cancelled (Section 4.13) and a new Procedure Scheduled transaction shall be initiated for the “new” order.
- 3240
- 3245

See RAD TF-1: 4.3 (Unidentified Patient Image Acquisition) for illustrations of the following discussions:

- 3250 • Case 1: In the case where a Temporary Patient Name and ID are assigned by an ADT system and an order is placed at the Order Placer, a Procedure Update transaction is not necessary (only a Patient Update transaction is necessary).
- Case 2: In the case where a Temporary Patient Name and ID are assigned by an ADT system but the order is placed at the Department System Scheduler, a Procedure Update transaction is not necessary (only a Patient Update transaction is necessary).

3255 In both cases 1 and 2, the DICOM attribute information mapping given in the Procedure Scheduled Transaction remains the same. That is, the Study Instance UID, Requested Procedure ID, Accession Number, etc., are supplied by the Department System Scheduler, are used by the modality and Image Manager or Report Manager, and are not changed.

- 3260 • Case 3: In this case a Temporary Patient Name and ID are assigned by an ADT system, no order is placed prior to image acquisition, but rather an order is placed after the exam is completed, the Study Instance UID is generated by the acquisition modality, and a Modality Performed Procedure Step is sent to the Image Manager, Report Manager and Department System Scheduler (containing the modality generated Study Instance UID). As always, the Study Instance UID contained within an object set remains the “master” key.

3265 At this point, a Procedure Scheduled transaction (Control Code = NW) must be sent to the Image Manager and Report Manager using the Study Instance UID contained in the MPPS message from the acquisition device. In this case, the information given in Table 4.4-20 must be altered by the Image Manager, Report Manager using the information received in the Procedure Update transaction by changing the DICOM objects.

3270 **Table 4.4-20: Data Mapping from ORM by Image Manager and Report Manager after Procedure Scheduled**

Attributes Overwritten in DICOM Instances Based on Procedure Scheduled information
Placer Order Number + Issuer
Filler Order Number + Issuer
Accession Number
Requested Procedure ID

3275 Note: In Case 3, the reconciliation of Scheduled Procedure Steps which are identified by the Department System Scheduler and contained in the Procedure Scheduled message with the Performed Procedure Steps that are actually contained in the DICOM objects (MPPS object) may not be consistent and do not need to be coerced. At this point, the number and identification of the Scheduled Procedure Steps is irrelevant because the procedure has already been performed.

If a race condition should occur such that the Department System Scheduler has just created a Procedure Scheduled Transaction (and generated a Study Instance UID) and the Modality has generated DICOM objects (and generated a different Study Instance UID), it is the responsibility of the Department System Scheduler to reconcile these transactions by canceling the order (and

3280 Study Instance UID) that it generated internally and create a new Procedure Scheduled  
transaction using the Study Instance UID generated by the modality and provided in the  
Modality Performed Procedure Step transaction. In cases where this is a multi-modality study  
with multiple Study Instance UIDs, multiple Procedure Scheduled transactions must be  
3285 Requested Procedure (see Sections 4.24 - 4.27).

In case 3, Patient Update [RAD-12] transaction(s) must still be sent to the Image Manager and  
Report Manager to update the patient demographic, visit information, and ID.

- Case 4: In the case where the Departmental System Scheduler assigns a Department  
Temporary Patient Name and ID and the procedure is scheduled, a Procedure Scheduled  
3290 transaction is necessary and adequately provides the Study Instance UID and other  
information given in Table 4.4-20. Subsequently, a Patient Update [RAD-12]  
transaction(s) is necessary.

- Case 5: In the case where no Temporary Patient Name nor ID are assigned by an ADT  
system, no order is placed in advance, but rather the patient is registered at the  
3295 Department System Scheduler and the order is placed after the exam is complete a  
Procedure Scheduled transaction (Control Code = NW) must be sent to the Image  
Manager and the Report Manager. Similar to case 3, the Study Instance UID obtained in  
the Modality Performed Procedure Step message shall be used as the key by both the  
Department System Scheduler the Image Manager and the Report Manager. The Image  
3300 Manager and the Report Manager must alter the information given in Table 4.4-11 using  
the information received in the Procedure Scheduled [RAD-4] transaction.  
In Case 5, a Patient Update [RAD-12] transaction(s) must still be sent to the Image  
Manager and Report Manager to update the patient demographic, visit information and  
ID.

3305

## 4.5 Query Modality Worklist [RAD-5]

### 4.5.1 Scope

3310 This transaction takes place under two circumstances. The first is for the scheduling of an acquisition, the second is for the scheduling of an importation of existing Evidence Objects or  
3315 Hardcopy. This transaction takes place at the Acquisition Modality at the point of scan/acquisition, or at the Radiopharmaceutical Activity Supplier (RAS) at the point of radiopharmaceutical administration, by a technologist. When a patient arrives for the scheduled procedure, the technologist performing the procedure must examine key information elements as they relate to the procedure, the correctness of the procedure that has been ordered, and  
3320 comments that may have been entered by the referring physician and/or radiologist, among others. The technologist at the Acquisition Modality or RAS uses the DICOM Modality Worklist to query the Department System Scheduler/Order Filler for Scheduled Procedure Steps. The list is downloaded to the Acquisition Modality or RAS and the technologist verifies the information on the Acquisition Modality or RAS console. In the Modality Images Stored transaction this information will be included in the header of the generated images (see Section 4.8 and RAD TF-2x: Appendix A).

3325 An importation may occur with existing DICOM Objects or the creation of DICOM Objects as part of the importation (e.g., the digitization of films into DICOM Objects). The actual scheduling of the importation may vary. For example, the importation may be scheduled as part of an externally referred acquisition, or upon the receipt of a physical PDI media containing patient images required for an upcoming consultation. The User at the Importer uses the DICOM Modality Worklist to query the Department System Scheduler/Order Filler for Scheduled Procedure Steps. The User must be able to verify that Evidence Objects or the Hardcopy data to be imported as DICOM Composite Objects are for the correct Patient and Scheduled Procedure  
3330 Step. In the Imported Objects Stored transaction this information will be included in the header of the imported Evidence Documents (see Section 4.61 and RAD TF-2x: Appendix A.5).

For an illustration of mapping between transactions [RAD-2], [RAD-3], [RAD-5], [RAD-6] and [RAD-7], see the IHE white paper “Code Mapping in IHE Radiology Profiles”, [https://www.ihe.net/uploadedFiles/Documents/Radiology/IHE\\_RAD\\_White-Paper\\_Codes.pdf](https://www.ihe.net/uploadedFiles/Documents/Radiology/IHE_RAD_White-Paper_Codes.pdf).

### 3335 4.5.2 Actor Roles

**Actor:** Acquisition Modality

**Role:** Responsible for requesting and receiving data from the Department System Scheduler/Order Filler.

**Actor:** Importer

3340 **Role:** Responsible for requesting and receiving data from the Department System Scheduler/Order Filler.

**Actor:** Department System Scheduler/Order Filler

**Role:** Responsible for accepting requests for MWL from an acquisition modality, performing the query, and sending the response back.

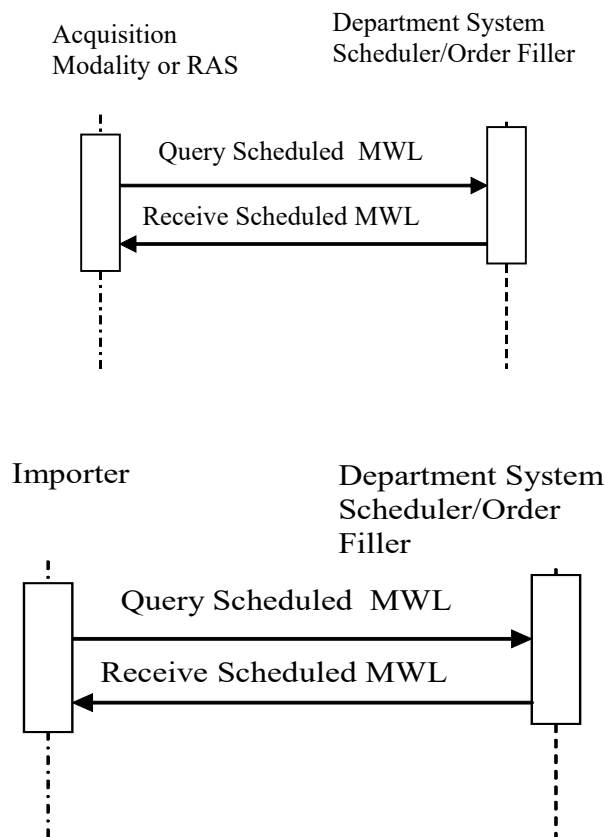
3345 **Actor:** Radiopharmaceutical Activity Supplier

**Role:** Responsible for requesting and receiving data from the Department System Scheduler/Order Filler.

### 4.5.3 Referenced Standards

DICOM [PS3.4 Annex K](#): Basic Worklist Management Service

### 3350 4.5.4 Messages



3355

**Figure 4.5.4-1: Interaction Diagram**

#### 4.5.4.1 Query Scheduled MWL Message

This is the worklist query request message sent to the Department System Scheduler/Order Filler.

#### 4.5.4.1.1 Trigger Events

3360 The patient arrives at the Acquisition Modality or Radiopharmaceutical Activity Supplier (RAS) for a procedure (scan/acquisition).

The trigger event for an importation is a User that wants to perform a scheduled importation. The actual trigger for scheduling the importation is site specific, but may be triggered by such events as:

- 3365
- Arrival of films as a result of a request for a scheduled consult.
  - Patient with a scheduled procedure brings prior Evidence Objects on a PDI Media.
  - Other communications not specified further by the IHE Radiology Technical Framework which result in the scheduling of an import.

#### 4.5.4.1.2 Message Semantics

3370 The Acquisition Modality, RAS, or Importer uses the C-FIND Request of the DICOM Modality Worklist SOP Class to query for the worklist from the DSS/Order Filler. The Acquisition Modality, RAS, or Importer performs the SCU role, and the DSS/Order Filler the SCP role.

An **Acquisition Modality** or a **RAS**:

- 3375
- shall support the required matching keys listed in Table 4.5-3 - Matching and Return Keys For Modality Worklist
  - shall support at least one of the following:
    - all combinations of the matching keys in Table 4.5-1: MWL Keys for Query by Patient
    - all combinations of the matching keys in Table 4.5-2: MWL Keys for Broad Worklist Queries
- 3380

An **Importer**:

- shall support the required matching keys listed in Table 4.5-3 - Matching and Return Keys For Modality Worklist
  - shall support all combinations of matching keys in Table 4.5-1: MWL Keys for Query by Patient
- 3385

1. **The Patient Based Query:** Query for a worklist specific for a particular patient. The SCU shall support all (15) combinations of the matching key attributes listed in Table 4.5-1 by including 1 or more keys.

3390

**Table 4.5-1: MWL Keys for Query by Patient**

Matching Key Attributes	Tag
Patient's Name	(0010,0010)



Matching Key Attributes	Tag
Patient ID	(0010,0020)
Accession Number	(0008,0050)
Requested Procedure ID	(0040,1001)

**2. The Broad Query:** Query for a broad worklist. The SCU shall support all (7) combinations of the matching key attributes listed in Table 4.5-2 by including 1 or more keys.

**Table 4.5-2: MWL Keys for Broad Worklist Queries**

Matching Key Attributes	Tag
Scheduled Procedure Step Start Date	(0040,0002)
Modality	(0008,0060)
Scheduled Station AE Title	(0040,0001)

3395 **4.5.4.1.2.1 Examples for the Use of Matching Key Attributes**

- Using the Scheduled Procedure Step Start Date: query for all the procedures in my department that are scheduled for the start date specified.
- Using the Modality key: query for all the procedures that are scheduled on this type of modality (e.g., all CT exams).
- Using AE Title key: query for all the procedures that are scheduled on the modality with the specified AE Title.
- Using the Scheduled Procedure Step Start Date and Modality keys: query for all the CT procedures that are scheduled for today.
- Using the Patient Name, Patient Birth Date and Patient Sex query for all the procedures that are scheduled for a patient.
- Using the Patient Name and AE Title query for all procedures to be imported for a Patient.

3400

3405

3410 Note: DICOM defines that dates and times are matched by their meaning, not as literal strings. If an application is concerned about how a single value matching of dates and times is performed by another application, it may consider using range matching instead (e.g., "<today>-<today>"), which is always performed by meaning.

Note: Applications are recommended to append a wildcard "\*", if one was not previously entered by the user, at the end of each component of the structured Patient Name.

**4.5.4.1.2.2 Matching Keys and Return Keys**

Table 4.5-3 contains both the matching key requirements and the return key requirements.

3415 Attributes with R+ or R+\* highlight additions to the DICOM Standard requirements for Modality Worklist SOP Class. See Section 2.2 for more information.

**An Acquisition Modality:**

- shall be able to request specific attributes (return keys)
- 3420 • shall be able to display in the user interface the returned value of attributes specified as R or R+
- shall map returned values into stored images as defined in Section 4.8 and RAD TF-2x: Appendix A
- may request additional return key attributes that might be displayed but not be inserted into the composite image object

3425 **A Radiopharmaceutical Activity Supplier (RAS):**

- shall be able to query for specific attributes (return keys)
- shall be able to display in the user interface the returned value of attributes specified as R or R+
- 3430 • shall map returned values into RRDSR objects. The requirements for the attributes in the stored Dose Reports are defined in RAD TF-2: Table 4.110.4.1.2-1.

**An Importer:**

- shall be able to request specific attributes (return keys)
- shall be able to display in the user interface the returned value of attributes specified as R or R+
- 3435 • shall use returned values to modify imported objects as defined in RAD TF-2: 4.61.4.1.2.1 and RAD TF-2x: Appendix A.5

**Table 4.5-3: Query Matching and Return Keys for Modality Worklist**

Attribute Name	Tag	Matching Keys		Return Keys	
		SCU	SCP	SCU	SCP
<b>Scheduled Procedure Step</b>					
Scheduled Procedure Step Sequence	(0040,0100)			[IHE-1]	[IHE-2]
>Scheduled Station AE Title	(0040,0001)	R+	R	R+*	R
>Scheduled Procedure Step Start Date	(0040,0002)	R+	R	R+	R
>Scheduled Procedure Step Start Time	(0040,0003)	O	R	R+	R
> Scheduled Procedure Step Location	(0040,0011)	O	O	O	O
>Modality	(0008,0060)	R+	R	R+	R
>Scheduled Performing Physician's Name	(0040,0006)	O	R	O	R
>Scheduled Procedure Step ID	(0040,0009)	O	O	R+*	R

IHE Radiology Technical Framework, Volume 2 (TF-2): Transactions

Attribute Name	Tag	Matching Keys		Return Keys	
		SCU	SCP	SCU	SCP
>Scheduled Protocol Code Sequence	(0040,0008)				
>>Code Value	(0008,0100)	O	O	R+*	R
>>Coding Scheme Version	(0008,0103)	O	O	O	O
>>Coding Scheme Designator	(0008,0102)	O	O	R+*	R
>>Code Meaning	(0008,0104)	O	O	R+	R+
>Scheduled Procedure Step Description	(0040,0007)	O	O	R+	R
<b>Requested Procedure</b>					
Requested Procedure Comments	(0040,1400)	O	O	O	O
Requested Procedure Description	(0032,1060)	O	O	R+	R
Requested Procedure Code Sequence	(0032,1064)				
>Code Value	(0008,0100)	O	O	R+*	R
>Coding Scheme Version	(0008,0103)	O	O	O	O
>Coding Scheme Designator	(0008,0102)	O	O	R+*	R
>Code Meaning	(0008,0104)	O	O	R+	R+
Requested Procedure ID	(0040,1001)	R+ (Note 1)	R+ (Note 1)	R+	R
Names of Intended recipients of results	(0040,1010)	O	O	O	O
Reason for the Requested Procedure [IHE-7]	(0040,1002)	O	O	R+*	R+
Reason for Requested Procedure Code Sequence [IHE-7]	(0040,100A)	O	O	R+*	R+
>Code Value	(0008,0100)	O	O	R+*	R+
>Coding Scheme Version	(0008,0103)	O	O	O	O
>Coding Scheme Designator	(0008,0102)	O	O	R+*	R+
>Code Meaning	(0008,0104)	O	O	R+*	R+
Study Instance UID	(0020,000D)	O	O	R+*	R
Referenced Study Sequence [IHE-3], [IHE-6]	(0008,1110)				
>Referenced SOP Class UID	(0008,1150)	O	O	R+*	R
>Referenced SOP Instance UID	(0008,1155)	O	O	R+*	R
Reason for the Requested Procedure	(0040,1002)	O	O	O	O
Reason for Requested Procedure Code Sequence	(0040,100A)				
>Code Value	(0008,0100)	O	O	O	O
>Coding Scheme Designator	(0008,0102)	O	O	O	O

Attribute Name	Tag	Matching Keys		Return Keys	
		SCU	SCP	SCU	SCP
>Coding Scheme Version	(0008,0103)	O	O	O	O
>Code Meaning	(0008,0104)	O	O	O	R+
<b>Imaging Service Request</b>					
Imaging Service Request Comments	(0040,2400)	O	O	O	O
Accession Number	(0008,0050)	R+ (Note 1)	R+ (Note 1)	R+	R+ [IHE-3]
Requesting Physician	(0032,1032)	O	O	O	R
Issuer of Accession Number Sequence	(0008,0051)				
>Local Namespace Entity ID	(0040,0031)	O	O	O [IHE-4]	O [IHE-5]
>Universal Entity ID	(0040,0032)	O	O	O [IHE-4]	O [IHE-5]
>Universal Entity ID Type	(0040,0033)	O	O	O [IHE-4]	O [IHE-5]
Requesting Service	(0032,1033)	O	O	O	O
Referring Physician's Name	(0008,0090)	O	O	R+	R
<b>Visit Identification</b>					
Institution Name	(0008,0080)	O	O	O [IHE-4]	O [IHE-5]
Institution Address	(0008,0081)	O	O	O [IHE-4]	O [IHE-5]
Institution Code Sequence	(0008,0082)	O	O	O [IHE-4]	O [IHE-5]
>Code Value	(0008,0100)	O	O	O [IHE-4]	O [IHE-5]
>Coding Scheme Designator	(0008,0102)	O	O	O [IHE-4]	O [IHE-5]
>Code Meaning	(0008,0104)	O	O	O [IHE-4]	O [IHE-5]
Admission ID	(0038,00100)	O	O	O	R
<b>Visit Status</b>					
Current Patient Location	(0038,0300)	O	O	O	R
<b>Visit Relationship</b>					
Referenced Patient Sequence	(0008,1120)				
>Referenced SOP Class UID	(0008,1150)	O	O	O	R
>Referenced SOP Instance UID	(0008,1155)	O	O	O	R
<b>Patient Identification</b>					
Patient's Name	(0010,0010)	R+	R	R+	R
Patient ID	(0010,0020)	R+	R	R+	R
Issuer of Patient ID	(0010,0021)	O	O	O [IHE-4]	O [IHE-5]
Issuer of Patient ID Qualifiers Sequence	(0010,0024)				
>Universal Entity ID	(0040,0032)	O	O	O [IHE-4]	O [IHE-5]
>Universal Entity ID Type	(0040,0033)	O	O	O [IHE-4]	O [IHE-5]
Other Patient IDs Sequence	(0010,1002)				
>Patient ID	(0010,0020)	O	O	O [IHE-4]	O [IHE-5]
>Issuer of Patient ID	(0010,0021)	O	O	O [IHE-4]	O [IHE-5]

Attribute Name	Tag	Matching Keys		Return Keys	
		SCU	SCP	SCU	SCP
>Type of Patient ID	(0010,0022)	O	O	O [IHE-4]	O [IHE-5]
>Issuer of Patient ID Qualifiers Sequence	(0010,0024)				
>>Universal Entity ID	(0040,0032)	O	O	O [IHE-4]	O [IHE-5]
>>Universal Entity ID Type	(0040,0033)	O	O	O [IHE-4]	O [IHE-5]
<b>Patient Demographic</b>					
Patients Birth Date	(0010,0030)	O	O	R+	R
Patient's Sex	(0010,0040)	O	O	R+	R
Confidentiality constraint on patient data	(0040,3001)	O	O	O	R
Ethnic Group	(0010,2160)	O	O	O	O
Patient Comment	(0010,4000)	O	O	O	O
<b>Patient Medical</b>					
Patient State	(0038,0500)	O	O	O	R
Pregnancy Status	(0010,21C0)	O	O	O	R
Medical Alerts	(0010,2000)	O	O	O	R
Additional Patient History	(0010,21B0)	O	O	O	O
Contrast Allergies	(0010,2110)	O	O	O	R
<u>Patient's Age [IHE-7]</u>	<u>(0010,1010)</u>	<u>O</u>	<u>O</u>	<u>R+*</u>	<u>R+</u>
<u>Patient Size [IHE-7]</u>	<u>(0010,1020)</u>	<u>O</u>	<u>O</u>	<u>R+*</u>	<u>R+</u>
Patient Weight	(0010,1030)	O	O	O	R
Special Needs	(0038,0050)	O	O	O	R
Admitting Diagnosis [IHE-7]	(0008,1080)	O	O	R+*	R+
Admitting Diagnosis Code Sequence [IHE-7]	(0008,1084)	O	O	R+*	R+
>Code Value	(0008,0100)	O	O	R+*	R+
>Coding Scheme Version	(0008,0103)	O	O	O	O
>Coding Scheme Designator	(0008,0102)	O	O	R+*	R+
>Code Meaning	(0008,0104)	O	O	R+*	R+

Note 1: The matching performed by the SCP for the Requested Procedure ID and Accession Number attributes shall be single value (SV) matching.

3440 [IHE-1]: SCU implementations may choose to obtain the values contained in attributes that are part of the Scheduled Procedure Step sequence in either one of three ways. The first one is to request a universal match on the sequence attribute (zero length attribute). The second one is to request a universal sequence match (zero length item) for all attributes of the Scheduled Procedure Step sequence. The third one is to request a universal attribute match for selected attributes contained in the Scheduled Procedure Step sequence.

3445

[IHE-2]: SCP implementations shall support, per the DICOM Standard, three ways to let the Query SCU obtain the values contained in attributes that are part of the Scheduled Procedure

3450 Step sequence. The first one is to support a universal match on the sequence attribute (zero length attribute), and all managed attributes will be returned. The second one is to support a universal sequence match (zero length item) for all attributes of the Scheduled Procedure Step sequence, and all managed attributes will be returned. The third one is to support a universal attribute match for selected attributes contained in the Scheduled Procedure Step sequence, and the managed attributes that were selected will be returned.

3455 [IHE-3]: A value (Non empty field) shall be returned in the Accession Number attribute if the field was requested by the MWL SCU.

[IHE-4]: Acquisition Modalities that support the Enterprise Identity Option shall request Institution Name, Institution Address, Institution Code Sequence, Issuer of Accession Number Sequence, Other Patient IDs Sequence and Issuer of Patient ID Qualifiers Sequence. See Section 4.5.4.1.2.3. The normal DICOM rules for Sequence Matching apply.

3460 [IHE-5]: DSS/Order Fillers that support the Enterprise Identity Option shall provide the Institution Name, Institution Address, Institution Code Sequence, Issuer of Accession Number Sequence, Other Patient IDs Sequence and Issuer of Patient ID Qualifiers Sequence upon request by an SCU. The normal DICOM rules for Sequence Matching apply. See Section 4.5.4.1.2.3.

3465 [IHE-6]: In the Query Modality Worklist provided by an Order Filler, the Referenced Study Sequence shall contain only one Referenced SOP Class UID and one Referenced SOP Instance UID for each Scheduled Procedure Step. Furthermore, the Referenced SOP Instance UID contained in the Referenced Study Sequence shall contain the same UID value as the Study Instance UID for a Requested Procedure. Note that this UID value is also conveyed to the Image Manager in the Study Instance UID field of the Procedure Scheduled transaction.

3470 Note: The Study Instance UID in the Referenced SOP Instance UID refers to a “non-instantiated” instance of the normalized Study SOP Class, not to a composite SOP Instance.

[IHE-7]: The requirements for the Query Return Key for this attribute apply to SCU and SCP implementations of actors in the REM-NM Profile; for actors in all other profiles, the optionality is “O”.

3475 **4.5.4.1.2.3 Enterprise Identity Option**

An Acquisition Modality supporting the Enterprise Identity Option shall request additional return keys in its Modality Worklist. Table 4.5-3a contains attributes for the Query Keys Return that have optionality R+\* (rather than O) for the SCU in Table 4.5-3.

3480 A DSS/Order Filler supporting the Enterprise Identity Option shall provide the additional return keys in the Modality Worklist upon request from the SCU. Table 4.5-3a contains attributes for the Query Keys Return that have an optionality R+\* (rather than O) for the SCP in Table 4.5-3.

**Table 4.5-3a: MWL Query Return Keys for Enterprise Identity Option**

Return Key Attributes	Tag
Issuer of Accession Number Sequence	(0008,0051)
>Local Namespace Entity ID	(0040,0031)

Return Key Attributes	Tag
>Universal Entity ID	(0040,0032)
>Universal Entity ID Type	(0040,0033)
Issuer of Patient ID	(0010,0021)
Issuer of Patient ID Qualifiers Sequence	(0010,0024)
>Universal Entity ID	(0040,0032)
>Universal Entity ID Type	(0040,0033)
Other Patient IDs Sequence	(0010,1002)
>Patient ID	(0010,0020)
>Issuer of Patient ID	(0010,0021)
>Issuer of Patient ID Qualifiers Sequence	(0010,0024)
>>Universal Entity ID	(0040,0032)
>>Universal Entity ID Type	(0040,0033)
>Type of Patient ID	(0010,0022)
Institution Name	(0008,0080)
Institution Address	(0008,0081)
Institution Code Sequence	(0008,0082)
>Code Value	(0008,0100)
>Coding Scheme Designator	(0008,0102)
>Code Meaning	(0008,0104)

#### 4.5.4.1.3 Expected Actions

3485 The Departmental System Schedule/Order Filler performs the query and sends the DICOM Modality Worklist to the Acquisition Modality, Importer, or RAS.

The Importer shall make available to the Operator the information in the Scheduled Procedure Step Description (see Table 4.5-3). This information may include:

- A description of specific Evidence Objects to import (e.g., only a particular study, series or image should be imported).

#### 3490 4.5.4.1.3.1 Intentionally Left Blank

#### 4.5.4.2 Receive Scheduled MWL Message

This is the message that the Department System Scheduler sends to the modality as a reply containing DICOM Modality Worklist information.

#### 4.5.4.2.1 Trigger Events

3495 The Departmental System Scheduler/Order Filler had received a query for a MWL.

#### 4.5.4.2.2 Message Semantics

3500 C-FIND Response from the DICOM Modality Worklist SOP Class will be used for this message. Some of the attributes queried through the MWL SOP class originate with the Order Placer and ADT, while other attributes are managed internally by the Department System Scheduler/Order Filler.

3505 The DSS/Order Filler will determine the Requested Procedures needed to fulfill the Order, and decompose the Requested Procedures into one or more Scheduled Procedure Steps, assigning proper Scheduled Protocol Codes. The DSS/Order Filler shall support the definition of multiple Protocol Codes in a Scheduled Protocol Code Sequence contained in the Scheduled Procedure Steps for any Requested Procedure. Coded Values shall be used to specify exactly what actions are to be performed at the Acquisition Modality - the DSS/OF shall be configurable to provide such codes.

3510 In addition to these Coded Values further instructions for the technologist may be specified. It is recommended to use the Scheduled Procedure Step Description and the Requested Procedure Description attributes for these additional specific instructions (free text).

The organization operating the DSS/OF and the Modalities is responsible for synchronizing Procedure and Protocol Codes between all the systems that use such codes. IHE does not yet define a common mechanism for code synchronization or access.

3515 RAD TF-2x: Appendix B defines the origin and mappings of the attributes returned in a MWL query.

3520 The details of the C-FIND Response from the DICOM MWL SOP Class are depicted in Table 4.5-3 and RAD TF-2x: Appendix A. At the time images are being created/generated, these attributes will be stored into the DICOM image instance headers. The Acquisition Modality or Importer may need additional information; however, this is beyond the scope of this document. Refer to RAD TF-1x: Appendix A for a discussion of Accession Number and Procedure ID.

3525 An Order may be cancelled after the corresponding Requested Procedure(s) and Scheduled Procedure Steps have been scheduled, and possibly even after a Performed Procedure Step has been started. In this case the Department System Scheduler/Order Filler shall remove the Scheduled Procedure Steps of the Order from its worklist, and the absence of these Scheduled Procedure Steps in the next C-FIND response to the Acquisition Modality or Importer will indicate that the procedure has been cancelled. In this way the technologist recognizes that the previously scheduled steps no longer need to be performed.

3530 It is the responsibility of the Department System Scheduler/Order Filler to ensure that the patient and procedure information is current in the Modality Worklist response. The Department System Scheduler/Order Filler receives patient and procedure updates through transactions [RAD-2], [RAD-3] and [RAD-12].

##### 4.5.4.2.2.1 Scheduled Protocol Sequence for Import

The Department System Scheduler/Order Filler has the ability to provide instructions to the Importer on what should be done with the imported Evidence Objects after they are imported



3535 through the use of the Scheduled Protocol Sequence (0040,0008). Zero or more items may be present. Table 4.5-4 provides a list of the valid codes that may be used.

If present the codes are intended to be made available for copying into the Performed Protocol Sequence (0040,0260) in order to convey the subsequent use of the instances.

**Table 4.5-4: Import Instruction Codes**

<b>Coding Scheme Designator (0008,0102)</b>	<b>Code Value (0008,0100)</b>	<b>Code Meaning (0008,0104)</b>
IHERADTF	IRWF001	Import
IHERADTF	IRWF002	To be interpreted
IHERADTF	IRWF003	To be archived
IHERADTF	IRWF004	To be over read
IHERADTF	IRWF005	To be post-processed
IHERADTF	IRWF006	To be printed
IHERADTF	IRWF007	To be provided as a prior
IHERADTF	IRWF008	Destroy original media
IHERADTF	IRWF009	Return original media to patient
IHERADTF	IRWF010	Return original media to sender
IHERADTF	IRWF011	Archive original media

3540 **4.5.4.2.2 Intentionally Left Blank**

**4.5.4.2.3 Expected Actions**

The technologist checks for the existence of the Scheduled Procedure Steps, validates the displayed patient and procedure information, and checks the given instructions.

3545 When an Acquisition Modality supports the Assisted Acquisition Protocol Setting Option, it shall provide the means to use the protocol codes specified in the Scheduled Procedure Steps selected from the Modality Worklist (see Section 4.6.4.1.2.4.2 Assisted Acquisition Protocols Setting Option).

3550 For imports, the User checks for the existence of the Scheduled Procedure Steps, validates the selected Patient Demographics with the Patient demographics of the existing Evidence Objects or the hardcopy, and checks for special instructions given in the Scheduled Procedure Step Description on what Evidence Objects are to be imported (e.g., how many PDI Media or films are associated with the Scheduled Procedure Step). In addition, the Importer shall provide the means to use the protocol codes specified in the Scheduled Procedure Step selected from the Modality Worklist (see Section 4.59.4.1.2.3.3 Import Instruction Codes).

3555 **4.5.4.2.3.1 Intentionally Left Blank**

## 4.6 Modality Procedure Step In Progress [RAD-6]

### 4.6.1 Scope

3560 This transaction includes a message from the Acquisition Modality to the Performed Procedure  
Step Manager, which in turn issues the message to the Department System Scheduler/Order  
Filler, the Image Manager and the Report Manager that the Performed Procedure Step is in  
3565 progress. This may be an unscheduled procedure step. The receiving Performed Procedure Step  
Manager is grouped with the Image Manager or the Department System Scheduler/Order Filler,  
and shall support forwarding messages to two other destinations besides the actor it is grouped  
with. It shall start issuing messages to the configured destinations immediately after it accepts  
the corresponding messages from the Acquisition Modality.

To allow for proper integration, the following considerations must be taken into account:

- 3570 • The Performed Procedure Step Manager must maintain proper PPS objects and then store  
them until corresponding N-CREATE and N-SET messages are transmitted to the actor it  
is grouped with, and the two other Actors. If transmission to a destination fails, the  
Performed Procedure Step Manager shall try to repeat transmission periodically until it  
succeeds. The Performed Procedure Step Manager must not use failure of one or more of  
3575 these transmissions as a reason for rejecting the initial transmission from the Acquisition  
Modality;
- Because both the Image Manager and the Department System Scheduler/Order Filler  
incorporate the Performed Procedure Step Manager function, an infinite redistribution of  
PPS messages is possible. The Image Manager and the Department System  
3580 Scheduler/Order Filler systems that provide the Performed Procedure Step Manager  
function shall be configurable to disable this function;
- Transfer of the information to the system that the receiving Performed Procedure Step  
Manager is integrated with is outside the scope of the IHE Radiology Technical  
Framework (i.e., internal to an implementation).

3585 For an illustration of mapping between transactions [RAD-2], [RAD-3], [RAD-5], [RAD-6] and  
[RAD-7], see the IHE white paper “Code Mapping in IHE Radiology Profiles”,  
[https://www.ihe.net/uploadedFiles/Documents/Radiology/IHE\\_RAD\\_White-Paper\\_Codes.pdf](https://www.ihe.net/uploadedFiles/Documents/Radiology/IHE_RAD_White-Paper_Codes.pdf).

### 4.6.2 Actor Roles

**Actor:** Department System Scheduler/Order Filler

**Role:** Receives the PPS information forwarded by the PPS Manager

3590 **Actor:** Image Manager

**Role:** Receives the PPS information forwarded by the PPS Manager

**Actor:** Report Manager

**Role:** Receives the PPS information forwarded by the PPS Manager

**Actor:** Acquisition Modality

3595 **Role:** Informs the Performed Procedure Step Manager that a particular Performed Procedure Step has started

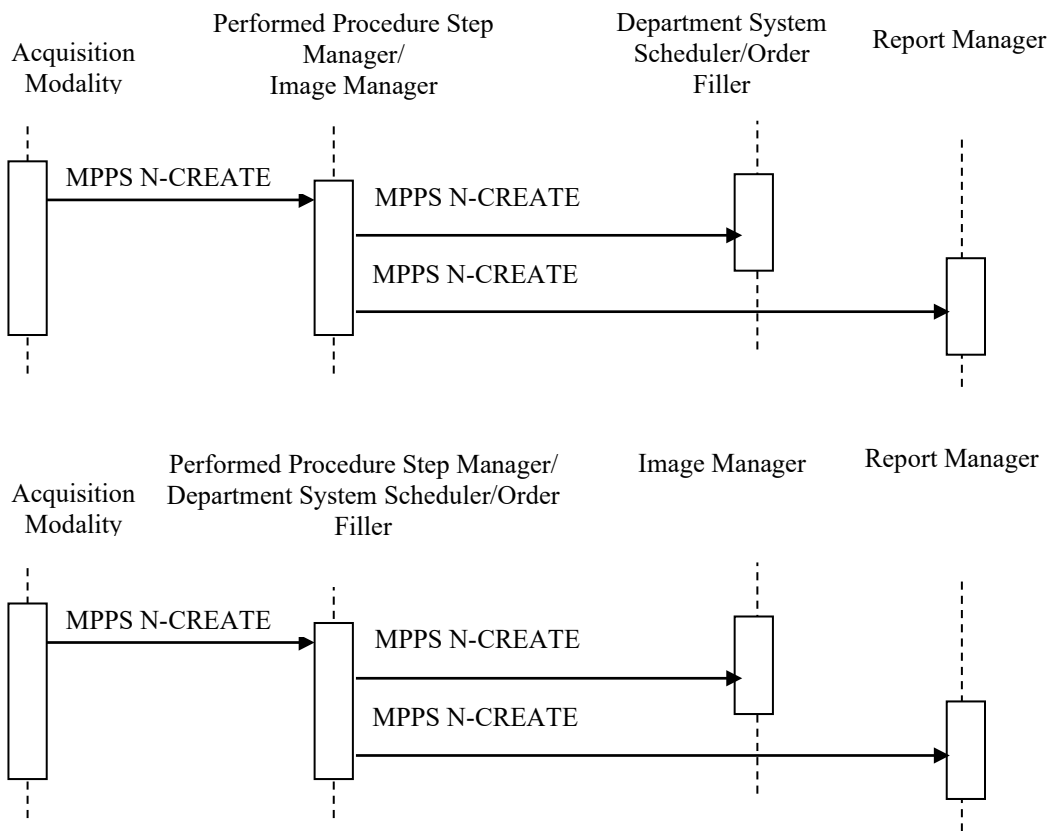
**Actor:** Performed Procedure Step Manager

3600 **Role:** Accepts Performed Procedure Step information from an Acquisition Modality and transmits it to the Department System Scheduler/Order Filler, Image Manager and Report Manager

### 4.6.3 Referenced Standards

DICOM [PS3.4 Section F.7](#): Modality Performed Procedure Step SOP Class.

### 4.6.4 Messages



3605

**Figure 4.6.4-1: Interaction Diagram**

#### 4.6.4.1 Procedure Step In Progress Message

##### 4.6.4.1.1 Trigger Event

Technologist begins procedure step from the Acquisition Modality console.

3610 **4.6.4.1.2 Message Semantics**

The Acquisition Modality uses the Modality Performed Procedure Step SOP Class (N-CREATE Service) to inform the Performed Procedure Step Manager that a specific Procedure Step has been started and is in progress. In turn, the Performed Procedure Step Manager uses the N-CREATE service to forward the information to the Department System Scheduler/Order Filler Image Manager and Report Manager. The SOP Instance UID value of the Performed Procedure Step shall be conveyed in the Affected SOP Instance UID (0000,1000) during this interchange (see also corresponding notes in RAD TF-2x: Appendix A.1). The following aspects shall be taken into account during implementation of this step:

3615

**4.6.4.1.2.1 Patient/Procedure/Scheduled Procedure Step Information**

3620 The Acquisition Modality shall ensure that the Patient/Procedure/Scheduled Procedure Step information it has is valid and current.

**4.6.4.1.2.2 Required Attributes**

3625

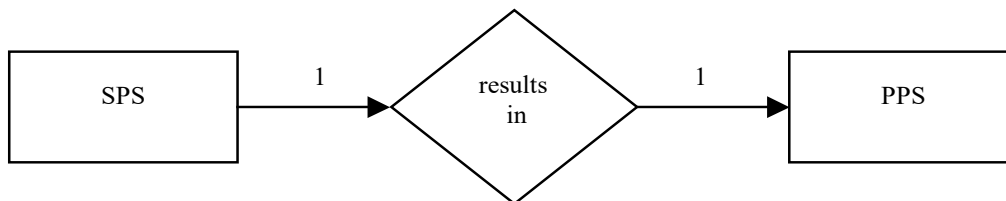
RAD TF-2x: Appendix A lists a number of attributes that have to be properly handled by the Acquisition Modality to ensure consistency between the Performed Procedure Step object attributes, Scheduled Step information in the Modality Worklist, and the information included in the generated SOP instances.

**4.6.4.1.2.3 Relationship between Scheduled and Performed Procedure Steps**

3630

The relationship between Scheduled and Performed Procedure Step information is shown in the following 6 cases. Refer to RAD TF-2x: Appendix A for details of forming attributes (Study Instance UID, Procedure ID, Accession Number, etc.) in each of these cases.

**4.6.4.1.2.3.1 Simple Case**

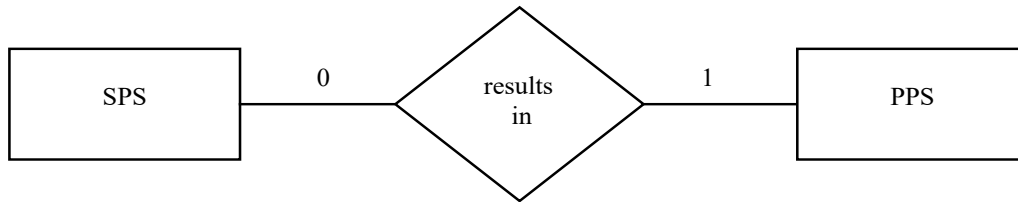


3635

This case indicates a 1-to-1 relationship between SPS and PPS. Information about the Scheduled Procedure Step and Requested Procedure shall be copied from the Scheduled Procedure Step object to the Performed Procedure Step Relationship Module (see RAD TF-2x: Appendix A).

Examples: A Procedure Step was performed exactly as scheduled. It could also be that a Procedure Step was not exactly performed as scheduled, but without being rescheduled, e.g., due to a patient's allergic reaction to contrast media.

#### 4.6.4.1.2.3.2 Unscheduled Case

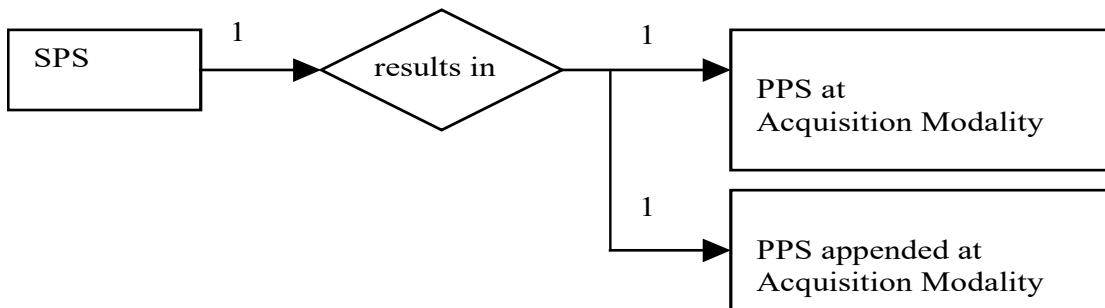


3640

This case indicates a 0-to-1 relationship between SPS and PPS. Information about the Scheduled Procedure Step and, possibly, Requested Procedure is not available to the Acquisition Modality due to different reasons (emergency procedure, Modality Worklist SCP not available, etc.).

3645 The Patient ID entered on the Acquisition Modality by the technologist shall be the one created by the Assigning (Issuer) Authority (refer to RAD TF-2x: Appendix D).

#### 4.6.4.1.2.3.3 Append Case



#### Append to a Normal Case

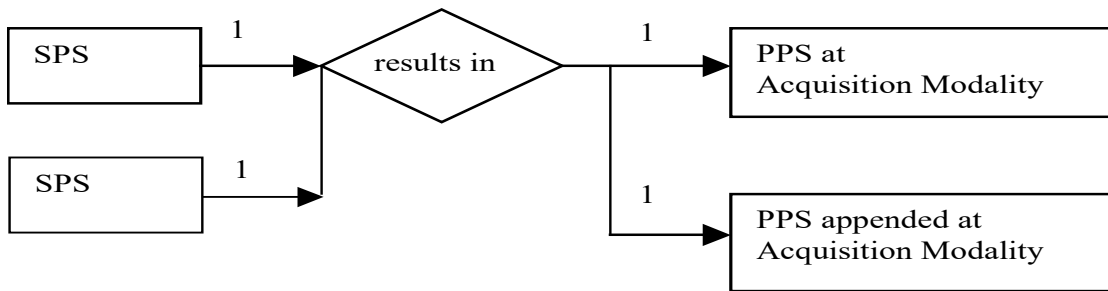
3650 This is a case of 1-to-N relationship between SPS and PPS where first the PPS is generated in response to an SPS, as in the simple case. Other Performed Procedure Steps that have not been scheduled by additional SPSs are added sequentially at a later time, for instance

- due to unacceptable quality of certain images (“redo” certain images)
- because head MR images from a patient with severe headache that were just acquired are inconclusive, so that additional neck MR images are performed immediately (“add” certain images)

3655

Note that the scheduling of the additional procedure would have resulted in two simple cases.

3660 All Performed Procedure Steps shall refer back to the same Requested Procedure and to the original SPS. All Requested Procedure and Scheduled Procedure Step attributes shall be copied from the Scheduled Procedure Step Object to the Performed Procedure Step Relationship Module and the image Request Attribute Sequence (see RAD TF-2x: Appendix A).

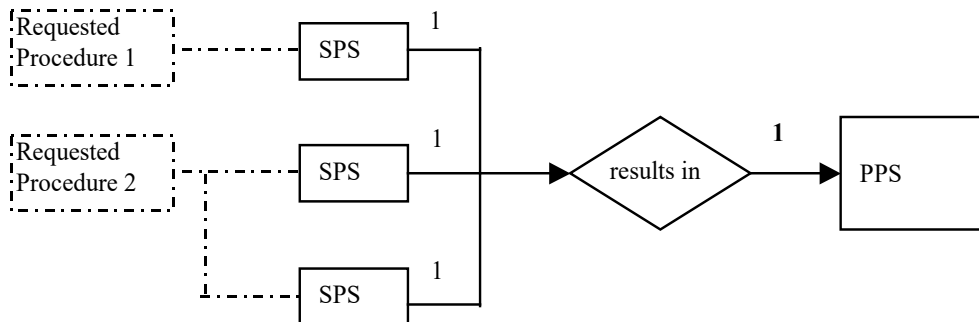


**Append to a Group Case**

3665 When the first PPS generated at the Acquisition Modality results from a Group Case (see Section 4.6.4.1.2.3.4 or 4.6.4.1.2.3.6), the Performed Procedure Step appended by the Acquisition Modality may refer back to any one or all of the original SPSs and related Requested Procedure(s), using information from the Request Attribute Sequence in the original images. The corresponding attributes shall be copied to the Performed Procedure Step Relationship Module and the image Request Attribute Sequence (see RAD TF-2x: Appendix A).

3670 Note: For example, following a PPS performed on an MR Modality in response to the grouping of a "neck" SPS and a "head" SPS, a 3D analysis on the MR head images is performed on the modality. This modality application may choose to link the appended PPS associated with the 3D secondary captures images resulting from the 3D analysis with both the head and the neck SPS.

**4.6.4.1.2.3.4 Group Case**



3675 This case indicates an N-to-1 relationship between SPS and PPS. The following sub-cases shall be supported and fulfilled by a single Performed Procedure Step:

- Grouped SPSs belonging to a single Requested procedure
- Grouped SPSs belonging to multiple Requested Procedures
- 3680 • A combination of Grouped SPSs belonging to multiple Requested procedures and Grouped SPSs belonging to a single Requested Procedure.

If all grouped SPSs belong to the same Requested Procedure, then the Study Instance UID and Accession Number from the MWL shall be copied to the corresponding attributes of the grouped images and in the grouped PPS.

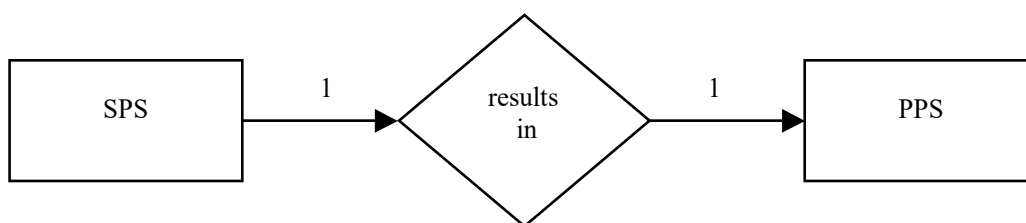
- 3685 If the grouped SPSs belong to different Requested Procedures sharing the same Accession Number (i.e., same Order), the Modality shall generate a new Study Instance UID and the Accession Number from the MWL shall be copied to the corresponding attributes of the grouped images and the grouped PPS (see RAD TF-2x: Appendix A.1-4 for mapping details). If the grouped SPSs belong to different Requested Procedures with different Accession Numbers (i.e., different Orders), the Modality shall generate a new Study Instance UID, leave the Accession Number empty in grouped Images and copy the Accession Number from the MWL to the corresponding attributes in grouped PPS (see RAD TF-2x: Appendix A.1-4 for mapping details).

- 3690 All Requested Procedure and Scheduled Procedure Step attributes shall be copied from the multiple Scheduled Procedure Step Objects (and associated Requested Procedures) to the Performed Procedure Step Relationship Module in the single Performed Procedure Step and to the Request Attribute Sequence in Images (see RAD TF-2x: Appendix A for proper mappings to MPPS and Images).

- 3700 Support for the group case by the Acquisition Modality is required in the Presentation of Grouped Procedures Integration Profile. In the Scheduled Workflow and Charge Posting Integration Profiles, a Modality may claim the support of the MODALITY GROUP CASE Option. When supported, this option implies that sub-cases a), b), and c) above shall be supported.

- 3705 The DSS/Order Filler, Image Manager Report Manager and Performed Procedure Step Manager are always required to accept Performed Procedure Steps containing attributes from multiple Scheduled Procedure Steps and Requested Procedures in Integration Profiles where those actors accept Modality Performed Procedure Step Transactions.

#### 4.6.4.1.2.3.5 Abandoned Case



- 3710 This case indicates a 1-to-1 relationship between SPS and PPS, even though the PPS may or may not create images. A procedure step may have to be abandoned for clinical reasons before it is complete. If SOP instances are sent by the Acquisition Modality to the Image Archive, then they shall be identified in the PPS N-SET. This is a means to explicitly communicate this information to the Image Manager or Department System Scheduler/Order Filler. In addition, one may choose to use this abandoned case to remove Scheduled Procedure Steps from the worklist, by
- 3715 starting the corresponding Performed Procedure Step and immediately discontinuing it using the

N-SET service with the status value DISCONTINUED. All Requested Procedure and Scheduled Procedure Step attributes shall be copied from the Scheduled Procedure Step Object to the Performed Procedure Step Relationship Module (see RAD TF-2x: Appendix A).

#### **4.6.4.1.2.3.6 Group Case with Presentation of Grouped Procedures**

3720 This case applies only in the context of the Presentation of Grouped Procedures Integration Profile. It applies to the subcases b) and c) of the Group Case (Section 4.6.4.1.2.3.4) and to the Append Case (Section 4.6.4.1.2.3.3) along with the rules specified in this section. Refer to RAD TF-1:6 for the use cases associated with the Presentation of Grouped Procedures. Presentation of Grouped Procedures in the a) subcase is equivalent to the use of the CPI Integration Profile. It is therefore out of scope for this section.

3725 First, this case indicates an N-to-1 relationship between SPS and a first PPS. SPSs belong to two or more different Requested Procedures, and are fulfilled by a single Performed Procedure Step. This Performed Procedure Step is related to the images (and possibly presentation states, key image notes, etc.) acquired in a single acquisition. All Requested Procedure and Scheduled Procedure Step attributes shall be copied from the multiple Scheduled Procedure Step Objects to the Performed Procedure Step Relationship Module in the single Performed Procedure Step (see RAD TF-2x: Appendix A) and to the Request Attribute Sequence in Images (see RAD TF-2x: Appendix A). This is a proper subset of the Group Case specified in Section 4.6.4.1.2.3.4.

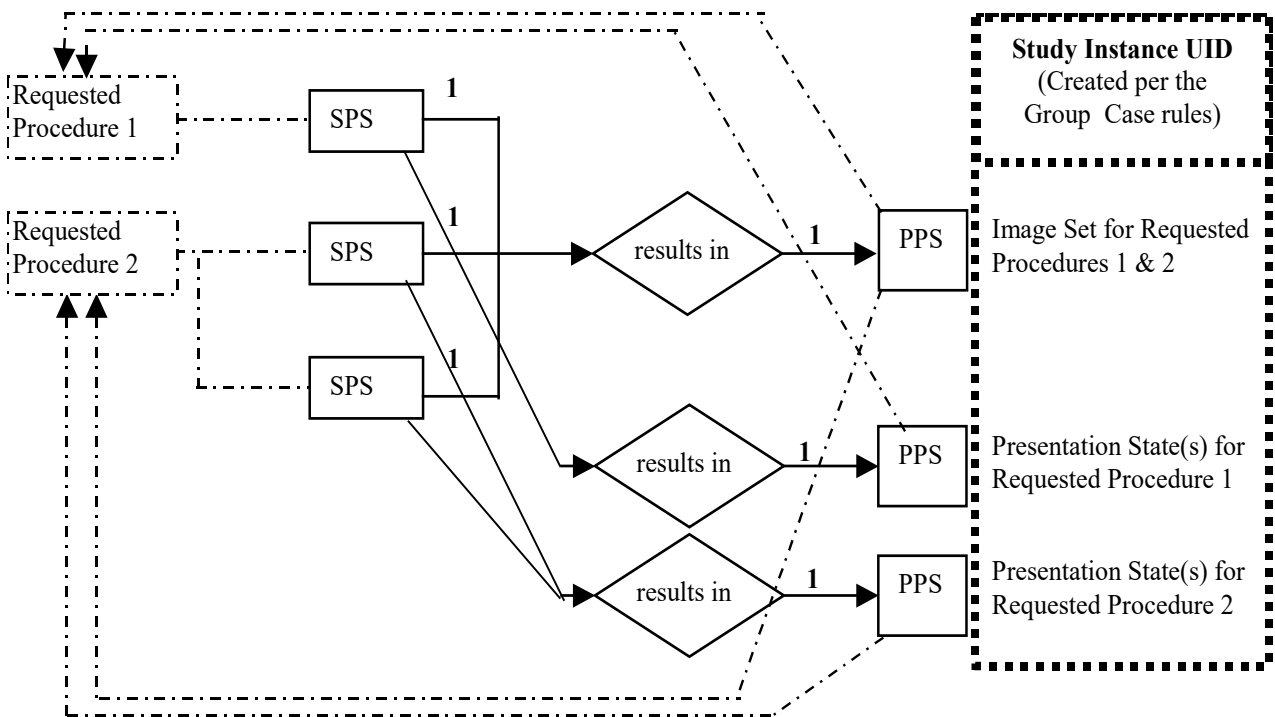
3730 Second, this case indicates a 1-to-1 relationship between the SPSs of each Requested Procedure and an additional corresponding PPS. All SPSs belonging to the same Requested Procedure are fulfilled by a corresponding Performed Procedure Step. The Requested Procedure and Scheduled Procedure Step attributes shall only be copied from the related Scheduled Procedure Step Object(s) to the Performed Procedure Step Relationship Module in the Performed Procedure Step (see RAD TF-2x: Appendix A) related to the specific Presentation State(s) intended to present the corresponding subset of images for the Requested Procedure. This is a proper subset of the Append Case specified in Section 4.6.4.1.2.3.3, with the exception that the Study Instance UID used for the Presentation States shall be the same as the one created for the image set acquired as part of the first PPS (see RAD TF-2x: Appendix A, Table A.1-4).

3735 The Presentation of Grouped Procedure operates at the Requested Procedure level whereas grouping operates at the level of Scheduled Procedure Steps.

3740

3745





#### 4.6.4.1.2.4 Protocol Handling

3750 The protocol (a specific combination of modality settings or a method) used in performing a procedure step shall be determined on the Acquisition Modality at this time. Two cases/options are defined: Manual Modality Setting and Assisted Modality Setting. The first case is the one that is currently most commonly used while the second case introduces new functionality and is optional for the IHE Technical Framework.

3755 The Acquisition Modality shall not change the Requested Procedure Code it obtains through the MWL. If the Requested Procedure Code is not correct or needs to be changed at the time the procedure is being performed, one of the following two methods shall be used:

- Department System Scheduler Method: The Procedure Information shall be corrected on the Department System Scheduler/Order Filler, and updated information shall be downloaded to the Acquisition Modality, OR
- 3760 • Acquisition Modality Method: The Acquisition Modality redefines Protocol Code(s) for the Procedure Steps it actually performs and sets the Procedure Code Sequence (0008,1032) to zero length.

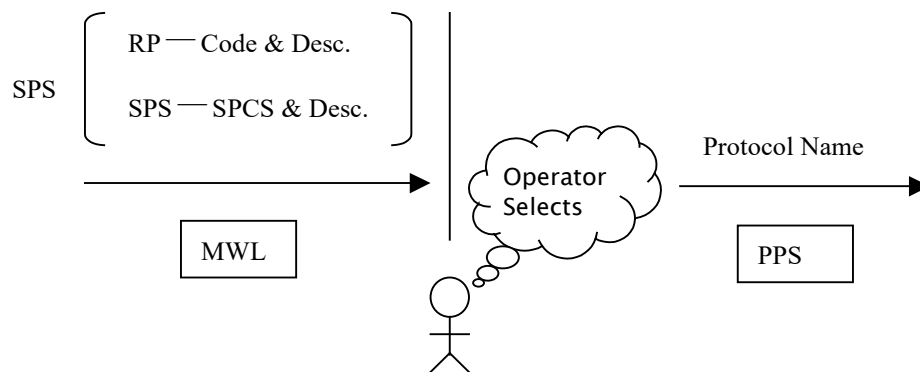
3765 The specification for which methods are required or optional is found in the Scheduled Workflow Integration Profile (RAD TF-1: 3.3.4) and in Scheduled Workflow.b (RAD TF-1: 34.4.2.4 – 34.4.2.5).

#### 4.6.4.1.2.4.1 Manual Modality Setting

3770 An operator selects and sets a protocol based on manual interpretation/evaluation of the Requested Procedure (RP) code and/or the Scheduled Procedure Step description and content of the Scheduled Protocol Code Sequence (SPCS). Note that the Scheduled Protocol Code Sequence, if present, may contain multiple items, however, they describe a single Protocol.

Note: Scheduled Action Item Code Sequence was redefined in 2001 by the DICOM standard as Scheduled Protocol Code Sequence.

3775 This approach may also be used in cases when the protocol identifies more of a method used in performing the acquisition (such as in ultrasound), rather than a set of fixed modality settings (such as in CT/MR).



In this Manual Modality Setting, the Scheduled Protocol Code Sequence is analyzed by the Operator. The Acquisition Modality is not required to provide a value for the Performed Protocol Code Sequence. (Only the Protocol Name is required to be sent).

#### 3780 4.6.4.1.2.4.2 Assisted Acquisition Protocol Setting Option

When an Acquisition Modality supports the Assisted Acquisition Protocol Setting Option, it shall provide the means to use the protocol codes specified in the Scheduled Procedure Steps selected from the Modality Worklist.

3785 According to DICOM [PS3.3 Section 7.3.1.8](#): "A Protocol is a specification of actions prescribed by a Procedure Plan to perform a specific Procedure Step. A Scheduled Procedure Step contains only one Protocol that may be conveyed with one or more Protocol Codes." So, each Scheduled Procedure Step is performed according to a single Protocol which may be identified by one or more Protocol Codes. This option refines the semantics of the interpretation of Protocol Codes specifically in the case where more than one Protocol Code is present.

3790 A Scheduled Procedure Step may contain a single Protocol Code, for example:

- A "Standard Chest X-ray" Protocol Code. This implies PA and Lateral views.
- A "Screening Mammography" Protocol Code. This implies RMLO and LMLO, RCC and LCC views.

3795 A Scheduled Procedure Step may also contain multiple Protocol Codes in cases where more complex SPS requires several acquisition or image processing tasks be performed in a sequential manner, for example:

- An “MRI Acquisition” Protocol Code followed by an “MRA Acquisition” Protocol Code.
- A “CT Head without contrast” Protocol Code followed by a “CT with contrast” Protocol Code.
- 3800 • A “CT Lumbar Spine” Protocol Code followed by a “Reformation of the discs” Protocol Code.
- A “CT Thorax” protocol Code followed by a “Recon with lung kernel” Protocol Code.

3805 In this option, an Acquisition Modality shall process the protocol code sequence in each Scheduled Procedure Step (SPS) selected from the Modality Worklist and return the Performed Protocol Codes in the Performed Procedure Step (PPS). Modalities shall support one or more codes in the Scheduled Protocol Code (SPC) sequence.

- Department System Schedulers will (per DICOM) support the use of more than one Protocol Code in the Scheduled Protocol Code (SPC) Sequence. The institution may decide to configure its Department System Scheduler to schedule all Scheduled  
3810 Procedure Steps with a single code in the SPC or with multiple codes in the SPC.

3815 The modality operator shall be able to either accept the protocol proposed by the set of Protocol Codes or select one or more alternative protocol defined on the Modality. The operator shall not be forced to manually enter the attributes of the acquisition protocol as in the Manual Modality Setting. The Assisted Acquisition Protocol Setting Option simplifies the operator’s work on the modality and enables a better management of the protocols used in an imaging department. This option may provide benefits for charge posting.

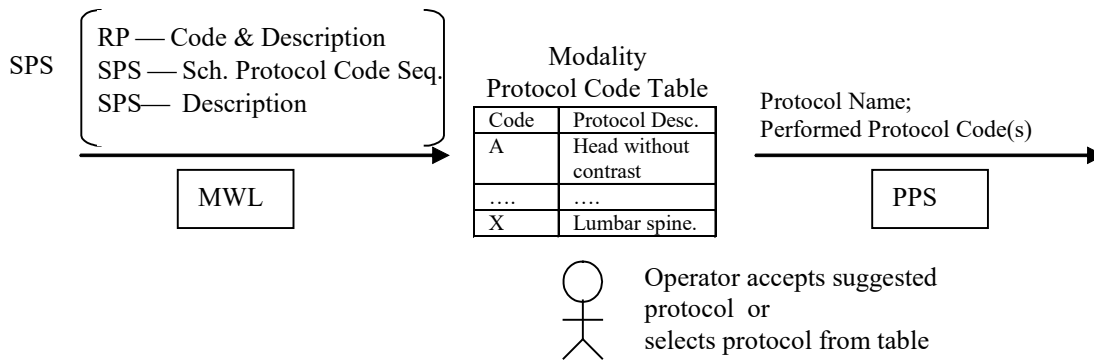
When multiple Scheduled Protocol Codes are present in the SPC Sequence, each Scheduled Protocol Code shall be analyzed independently (i.e., not as a compound code). It follows that:

- 3820 • The modality settings resulting from the simultaneous processing of the ordered set of Protocol Codes is semantically equivalent to the sequential processing of each Protocol Code independently. In other words, no additional semantics may be inferred from the simultaneous processing of multiple Protocol Codes in the sequence, and
- 3825 • Protocol Codes shall be proposed to the operator in the order defined in the sequence. The Operator may choose to perform this sequence of Protocol Codes in a different order than scheduled, omit performing some of the protocol codes or include others.

Whether the Scheduled Procedure Step includes one or several Protocol Codes, each Protocol Code shall be processed according to the Protocol Codes defined in the Modality Protocol Code Table. This table shall also be used for an interactive function that lets the user select protocols without manual text entry in the following manner:

- 3830 • If a match is found, the modality settings defined in the Modality Protocol Code Table shall be proposed to the operator. The operator may then choose to:

- Accept the settings (i.e., modality acquisition parameters) proposed. In this case the Performed Protocol Code will take the value of the Scheduled Protocol Code.
- 3835 • Accept the settings (modality acquisition parameters) and refine them. (Local policy will determine what refinements are acceptable within a specific protocol code). In this case the Performed Protocol Code will take the value of the Scheduled Protocol Code.
- 3840 • Reject the settings proposed and manually select another protocol defined in the Modality Protocol Table. In this case the Performed Protocol Code will take the value of the manually selected Protocol Code (see recommendations in RAD TF-2x: Appendix A Tables A.1-1 to A.1-5).
- If there is no identical Protocol Code defined in the Modality Protocol Table, the Acquisition Modality must alert the operator.
- A Modality Protocol Code Table shall be configurable on the Acquisition Modality.



- 3845 When the Assisted Acquisition Protocol Setting Option is supported by the Acquisition Modality, one or more values for the Performed Protocol Code Sequence shall be provided in addition to the Protocol Name. If multiple Protocol Codes have been selected and the corresponding acquisitions performed, the order of the Protocol Codes in the sequence shall reflect the order in which they were performed. This order may differ from the order in which they appeared in the Scheduled Protocol Code Sequence.
- 3850

The Assisted Acquisition Protocol Setting Option does not define a specific codification of acquisition protocols. The Acquisition Modality shall be configurable in order to support the codification scheme selected or defined by the healthcare enterprise.

#### 4.6.4.1.2.5 Enterprise Identity Option

- 3855 An Acquisition Modality supporting the Enterprise Identity Option shall copy values for the following Patient Context-critical attributes from the information received in the Modality Worklist, if provided, as specified in RAD TF-2x: Appendix A, to ensure consistency with the Performed Procedure Step object attributes, and the generated MPPS objects:

Patient Context-critical Attributes	Tag
Issuer of Patient ID	(0010,0021)
Issuer of Patient ID Qualifiers Sequence	(0010,0024)
>Universal Entity ID	(0040,0032)
>Universal Entity ID Type	(0040,0033)
Other Patient ID Sequence	(0010, 1002)
>Patient ID	(0010,0020)
>Issuer of Patient ID	(0010,0021)
>Issuer of Patient ID Qualifiers Sequence	(0010,0024)
>>Universal Entity ID	(0040,0032)
>>Universal Entity ID Type	(0040,0033)
>Type of Patient ID	(0010,0022)

3860

In the case where Issuer of Patient ID and Issuer of Patient ID Qualifiers Sequence attributes are not explicitly supplied by the DSS/Order Filler in the Modality Worklist (e.g., in the Unscheduled Case), the Acquisition Modality shall not include values for these attributes in the generated SOP Instances.

3865

Note: this requirement is intended to reduce complexity of information reconciliation on the Image Manager and Order Filler. An implementation that supports configuration of default values for these attributes will need to be configured, so that these defaults contain no value.

3870

An Acquisition Modality supporting the Enterprise Identity Option shall copy values for the following Accession Context-critical attributes from the information received in the Modality Worklist, if provided, as specified in RAD TF-2x: Appendix A to ensure consistency with the Performed Procedure Step object attributes, and the information included in the generated MPPS objects.

Accession Context-critical Attributes	Tag
Issuer of Accession Number Sequence	(0008,0051)
>Local Namespace Entity ID	(0040,0031)
>Universal Entity ID	(0040,0032)
>Universal Entity ID Type	(0040,0033)

3875

#### 4.6.4.1.3 Expected Actions

The Department System Scheduler/Order Filler, Report Manager and the Image Manager/Image Archive receive information from the Performed Procedure Step Manager and link it with the Requested Procedure and Scheduled Procedure Step. If the Requested Procedure ID is transmitted empty (Unscheduled Performed Procedure Step case), the Department System

3880 Scheduler/Order Filler and the Image Manager shall create an exception that must be manually resolved to link the Performed Procedure Step to the appropriate procedure.

**4.6.4.1.3.1 Intentionally Left Blank**

3885 **4.7 Modality Procedure Step Completed/Discontinued [RAD-7]**

**4.7.1 Scope**

3890 This transaction includes a message from the Acquisition Modality to the Performed Procedure Step Manager, which in turn issues messages to the DSS/Order Filler, the Report Manager and the Image Manager that the Performed Procedure Step has been completed. Information is not being released for billing at this point but a code may be assigned. The Image Manager may need the information to co-locate images of the same study. The Modality Procedure Step Completed message does not necessarily mean that the set of images is complete or available for retrieval.

3895 For an illustration of mapping between transactions [RAD-2], [RAD-3], [RAD-5], [RAD-6] and [RAD-7], see the IHE white paper “Code Mapping in IHE Radiology Profiles”, [https://www.ihe.net/uploadedFiles/Documents/Radiology/IHE\\_RAD\\_White-Paper\\_Codes.pdf](https://www.ihe.net/uploadedFiles/Documents/Radiology/IHE_RAD_White-Paper_Codes.pdf).

**4.7.2 Actor Roles**

**Actor:** Department System Scheduler/Order Filler

**Role:** Receives the PPS information forwarded by the PPS Manager

**Actor:** Image Manager.

3900 **Role:** Receives the PPS information forwarded by the PPS Manager

**Actor:** Report Manager

**Role:** Receives the PPS information forwarded by the PPS Manager

**Actor:** Acquisition Modality

3905 **Role:** Informs the Performed Procedure Step Manager that a particular Performed Procedure Step is completed

**Actor:** Performed Procedure Step Manager

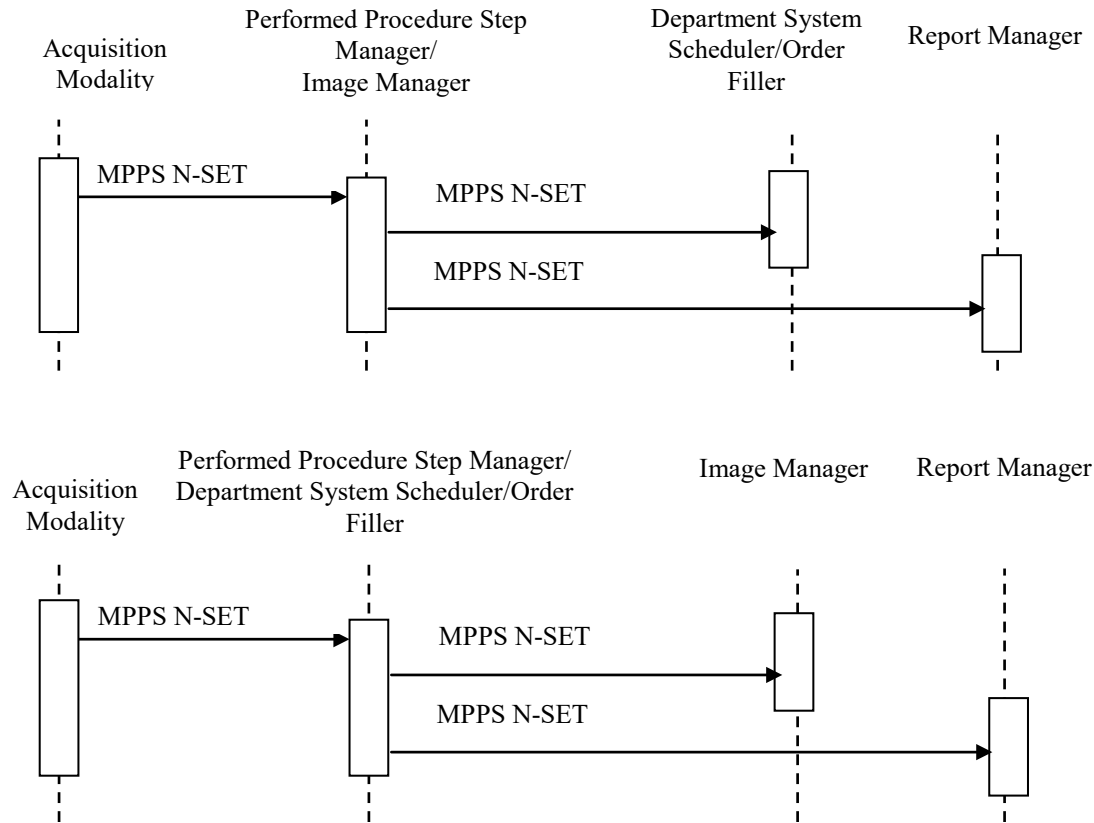
**Role:** Accepts Performed Procedure Step information from an Acquisition Modality and transmits it to the Department System Scheduler/Order Filler, Image Manager and Report Manager

3910 **4.7.3 Referenced Standards**

DICOM [PS3.4 Section F.7](#): Modality Performed Procedure Step SOP Class

DICOM [PS3.16 Annex B](#): DCMR Context Groups

## 4.7.4 Messages



3915

**Figure 4.7.4-1: Interaction Diagram**

Note: The diagram above shows the sequencing of messages for the Modality Performed Procedure Step SOP Class. Acquisition Modalities will also implement the Storage and Storage Commitment classes. The timing relationship between PPS messages and Storage and Storage Commitment messages is not specified. That is, PPS messages may occur before or after storage requests.

3920

### 4.7.4.1 Procedure Step Completed/Discontinued

#### 4.7.4.1.1 Trigger Event

Technologist completes procedure step from the Acquisition Modality console.

#### 4.7.4.1.2 Message Semantics

3925

The Acquisition Modality uses the Modality Performed Procedure Step SOP Class (N-SET service) to inform the Performed Procedure Step Manager that a specific Performed Procedure Step has been completed or discontinued. The Acquisition Modality may use the MPPS N-SET service to send intermediate updates of the Performed Procedure Step information.



3930 The final N-SET has either the MPPS status of "COMPLETED" or "DISCONTINUED". The Performed Procedure Step Manager sends corresponding N-SETs to the Department System Scheduler/Order Filler, Image Manager and Report Manager.

When an N-SET is issued with a "DISCONTINUED" status, one or more Series of Instances may be referenced, if images were created and sent. Those Instances shall be Stored and Storage Committed.

3935 Along with other information, the Acquisition Modality shall transmit information about the protocol it used to produce the SOP instances to the recipients. See Protocol Handling in Section 4.6.4.1.2.4 for detailed discussion of this issue.

Note: DICOM specifies that when attributes are allowed to be set by an N-SET, the value provided by the last N-SET overrides any value set by an earlier N-CREATE or N-SET.

#### 3940 **4.7.4.1.2.1 Retrieve AE Title**

According to the DICOM Standard, the Acquisition Modality has the ability to include the Retrieve AE Title attribute (0008,0054) in the Performed Series Sequence (0040,0340). This is an AE Title where the referenced SOP instances for the series may be retrieved. This Retrieve AE Title will often be of zero length or be of short-term validity, due to the following situations:

- 3945 • If an Acquisition Modality supports a Retrieve SOP Class in an SCP Role, the modality Retrieve AE Title may be included; however, the modality does not guarantee long-term availability.
- A Retrieve AE Title of the Image Manager can be configured on the Acquisition Modality. Otherwise, this field shall be sent zero length. Acquisition Modality
- 3950 implementers shall not assume that the destination AE Title used for the Storage SCP or Storage Commitment SCP is the same as that for Image Retrieval.
- An Acquisition Modality may receive the Retrieve AE Title in a Storage Commitment Message (N-EVENT REPORT). However, this information may be received well after the MPPS N-SET (Complete) was performed.

#### 3955 **4.7.4.1.2.2 PPS Exception Management Option**

When an Acquisition Modality supports the PPS Exception Management Option, it shall provide the appropriate reason codes (often selected by the operator) in the final N-SET sent with the status of DISCONTINUED.

3960 When the Modality Procedure Step is sent with the Status DISCONTINUED, the Modality Procedure Step Discontinuation Reason Code Sequence (0040,0281) shall be sent with one of the values defined in DICOM [PS3.16 Annex B CID 9301](#) Modality PPS Discontinuation Reasons.

The Reason Code when communicated to the DSS/Order Filler and Image Manager/Archive may imply canceling an order. It may also facilitate more accurate charge posting.

3965 The Reason Code: "Incorrect Worklist Entry Selected" is used by the Acquisition Modality to convey that the wrong SPS has been selected (incorrect patient or incorrect Requested procedure/order for the same patient). In this case some or all of the incorrectly acquired images

(for example the ones assigned to the wrong patient) may already have been stored to the image manager (see Section 4.7.4.1.3.1).

3970 Modality implementers are left free to decide how to correct the incorrectly acquired images. The Acquisition Modality shall include within the MPPS the list of images that are or will be included in the Images Stored Transaction(s).

3975 Note: When a PPS DISCONTINUED is sent with the reason code "incorrect worklist entry selected", images referenced in this PPS DISCONTINUED are images that may have been sent to the Image Manager/Archive. The IHE Technical Framework does not specify whether or not the Acquisition Modality needs to perform a Storage Commitment for these instances.

**4.7.4.1.2.3 Billing and Material Management Information**

3980 The message semantics are defined in the DICOM Service Class section of the DICOM Modality Performed Procedure Step SOP Class. It is the responsibility of the Acquisition Modality to ensure that the patient and procedure information is sent to the Department System Scheduler/Order Filler.

The Attributes defined in Table 4.7-2 provide a means to transmit procedure and material management codes from the acquisition modality to the DSS/Order Filler that uses them for calculation of charges to be posted to Charge Processor.

3985 An Acquisition Modality that supports the Billing and Material Management Option shall be able to provide content within at least one of the Billing Procedure Step Sequence, Film Consumption Sequence and Billing Supplies and Devices Sequence.

**Table 4.7-2 Billing and Material Management Code Module Attributes**

Attribute name	Tag	Attribute Description
Billing Procedure Step Sequence	(0040,0320)	Contains billing codes for the Procedure Type performed within the Procedure Step. The sequence may have zero or more Items See note IHE-1, IHE-2.
> Code Value	(0008,0100)	
> Coding Scheme Designator	(0008,0102)	
> Code Meaning	(0008,0104)	
Film Consumption Sequence	(0040,0321)	Information about the film consumption for this Performed Procedure Step. The sequence may have zero or more Items. Note: This is only for films printed from this device. See note IHE-3.
>Number of Films	(2100,0170)	Number of films actually printed.
>Medium Type	(2000,0030)	Type(s) of medium on which images were printed.
>Film Size ID	(2010,0050)	Size(s) of film on which images were printed.
Billing Supplies and Devices Sequence	(0040,0324)	Contains billing codes for chemicals, supplies and devices for billing used in the Performed Procedure Step. The sequence may have one or more Items.

Attribute name	Tag	Attribute Description
>Billing Item Sequence	(0040,0296)	Codes values of chemicals, supplies or devices required for billing. The sequence may have zero or one Items. See note IHE-4.
>> Code Value	(0008,0100)	
>> Coding Scheme Designator	(0008,0102)	
>> Code Meaning	(0008,0104)	
>Quantity Sequence	(0040,0293)	Sequence containing the quantity of used chemicals or devices. The sequence may have zero or one Items.
>>Quantity	(0040,0294)	Numerical quantity value.
>>Measuring Units Sequence	(0040,0295)	Unit of measurement. The sequence may have zero or one Items. Baseline DICOM <a href="#">PS3.16 CID 82</a>
>>> Code Value	(0008,0100)	
>>> Coding Scheme Designator	(0008,0102)	
>>> Code Meaning	(0008,0104)	

- 3990 • [IHE-1] Billing Procedure Step Sequence Attribute shall be present if Modality supports the Billing and Material Management Option. It may be sent zero-length if one of Film Consumption Sequence or Billing Supplies and Devices Sequence is also populated.
- 3995 • [IHE-2] A Modality Billing Code Table shall be configured on the Acquisition Modality. This table shall be synchronized with the Department System Scheduler/Order Filler. The codes provided by the Acquisition Modality might not be the same as the code the Department System Scheduler/Order Filler is required to use when posting Charges to the Charge Processor.
- 4000 • [IHE-3] Film Consumption Sequence shall be present if films have been printed during this Performed Procedure Step. Information provided in Film Consumption Sequence may not be sufficient to properly calculate charges. For example, to take into account quality and sensitivity of film, Department System Scheduler/Order Filler shall obtain additional information before calculating and posting charges to the Charge Processor.
- [IHE-4] Different coding schemes may be used for codes of Billing Items, for example, DCMR [CID 12](#) - Radiographic Contrast Agent may be used to record quantity of contrast used.

#### 4.7.4.1.2.4 Protocol Handling

4005 See Section 4.6.4.1.2.4 for a description of protocol handling.

#### 4.7.4.1.3 Expected Actions

4010 The Image Manager, Report Manager and Department System Scheduler/Order Filler receive information about the Performed Procedure Step being complete or discontinued. The Image Manager, Report Manager and Department System Scheduler are not required to act on intermediate N-SET messages with the MPPS Status "IN PROGRESS".

4015 The Requested Procedure may be considered complete if all Performed Procedure Steps related to all Scheduled Procedure Steps have been completed (or properly discontinued). Additional new (unscheduled) Performed Steps may be performed at any time, even after the Requested Procedure has been assigned complete scanning status. See relationship between Scheduled and Performed Procedure Steps in Section 4.6.4.1.2.3 for detailed discussion of this issue.

#### **4.7.4.1.3.1 PPS Exception Management Option**

When a DSS/Order Filler or Image Manager/Archive supports the PPS Exception Management Option, it shall use the reason codes in the final N-SET sent with the status of DISCONTINUED.

4020 When the Modality Procedure Step is received with the Status DISCONTINUED, the receiver shall interpret the Performed Procedure Step Discontinuation Reason Code Sequence (0040,0281) values as defined in DICOM (see Table 4.7-1). When received by the Department System Scheduler/Order Filler and the Image Manager/Archive, the Reason Code may indicate the necessity for modification or canceling of an order). With the Reason Code: “Incorrect Worklist Entry Selected”, the Acquisition Modality conveys that the wrong SPS has been  
4025 selected (e.g., incorrect patient or incorrect Requested procedure/order for the same patient). In this case the Image Manager and Department System Scheduler shall take the appropriate action to ensure that already received incorrect instances (i.e., SOP Instances referenced by this Discontinued PPS) are not mistakenly used. If the images, presentation states, or key image notes are not actually deleted, the Image Manager shall:

- 4030
- not return SOP Instance UIDs for the images in query responses
  - not return such images in Patient, Study, Series, or Instance level retrievals

On the DSS and Image Manager, the Order/Requested Procedure status shall be corrected to indicate that the discontinued PPS (with wrong worklist entry selected) is not valid. Therefore, the Order Filler/Department System Scheduler shall not query for those instances with an Image  
4035 Availability transaction.

#### **4.7.4.1.3.2 Billing and Material Management Information**

4040 When Billing and Material Management information is provided in the MPPS N-SET, the DSS/Order Filler shall use the billing codes and material usage information provided in the final N-SET for calculation of charges that it will eventually post to the Charge Processor. It is recommended that DSS/Order Filler verifies the consistency of provided billing codes with Requested Procedure Code and Performed Procedure Step Protocol codes supplied in the same N-SET.

#### **4.7.4.1.3.3 Intentionally Left Blank**

4045 **4.8 Modality Images Stored [RAD-8]**

**4.8.1 Scope**

In the Modality Images Stored transaction, the Acquisition Modality sends the acquired images to the Image Archive. The information provided from the Modality Worklist transaction (see Section 4.5) shall be included in the headers of the generated images.

4050 **4.8.2 Actor Roles**

**Actor:** Acquisition Modality

**Role:** Transmit acquired image data to Image Archive.

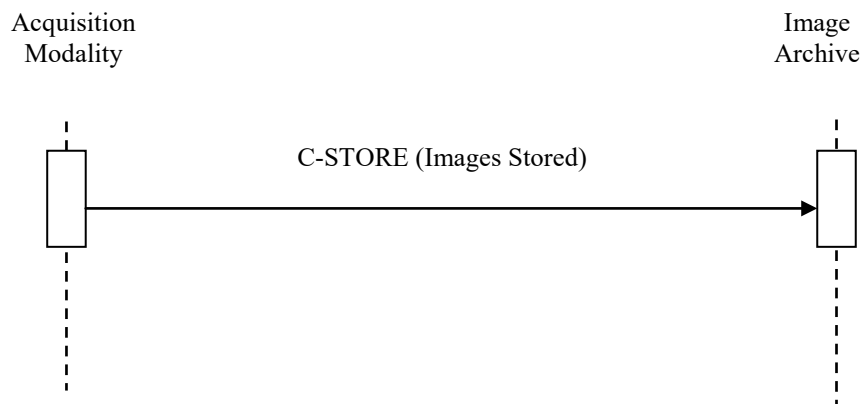
**Actor:** Image Archive

**Role:** Accept and store images from Acquisition Modalities.

4055 **4.8.3 Referenced Standards**

DICOM [PS3.4 Annex B](#): Storage Service Class

**4.8.4 Messages**



**Figure 4.8.4-1: Interaction Diagram**

4060 **4.8.4.1 Images Stored**

**4.8.4.1.1 Trigger Events**

The Acquisition Modality can transfer images to the Image Archive sequentially within one or more DICOM associations, as the images become available or collectively.

#### 4.8.4.1.1.1 Study UIDs and Series UIDs

4065 Study UID creation details and timing are clearly defined by the IHE. The Scheduled Workflow and Patient Reconciliation Profiles explain how the Study information and identifiers such as the Study Instance UID are generated by the Order Filler and made available to the modality through the Modality Worklist. Generation of these items by the modality or workstation are restricted in general and are only permitted in specifically outlined exception cases, when a PPS is  
4070 unscheduled (RAD TF-2x: Appendix A, Table A.1-2) or when several SPS belonging to different Requested Procedures are satisfied by a single PPS (RAD TF-2x: Appendix A, Table A.1-5).

Series UID creation must be compatible with a number of DICOM rules.

4075 Multiple performed procedure steps are not permitted to reference the same series. So conversely, one series cannot contain the output of different performed procedure steps. Therefore, adding images to a series in a procedure step which has been completed is not permitted since a procedure step cannot be modified.

Note that a series *may* fulfill more than one *scheduled* procedure step. This is referred to in IHE as the group case.

4080 Adding images after completion of a procedure step shall trigger the creation of a new series.

One series cannot contain the output of different equipment (in part because a series must have a single Frame Of Reference). Creating images on different equipment shall trigger the creation of a new series.

4085 All images in a series must share the same Frame Of Reference. Generally this means creating images with different patient positioning shall trigger the creation of a new series. Note that if the Frame Of Reference is not present (at the Series level), this requirement is avoided.

Images reconstructed on a different piece of equipment are required to be in a separate Series.

4090 For consistency, IHE specifies that reconstructed images shall be stored in a separate series from the acquired tomographic images from which they were reconstructed regardless of whether they are reconstructed on the Acquisition Modality or an Evidence Creator.

#### 4.8.4.1.2 Message Semantics

The Acquisition Modality uses the DICOM C-STORE message to transfer the images. The Acquisition Modality is the DICOM Storage SCU and the Image Archive is the DICOM Storage SCP.

4095 The technologist validates the available information for the patient and the Scheduled Procedure Step/Requested Procedure. It is a requirement that certain information be recorded in the image header. The details of the mapping to DICOM image instances are specified in RAD TF-2x: Appendix A. Effectively, that appendix strengthens the type definition of some DICOM attributes for the IHE Technical Framework.

4100 **4.8.4.1.2.1 Storage of Localizer Images (MR and CT)**

In addition to these general mapping requirements, in MR and CT images the relationship between localizer or plan images and related slice images shall be recorded when such slice images were planned or prescribed from the localizer or plan images. In this case, the attribute Referenced Image Sequence (0008,1140) of the slice image shall refer to the related localizer or plan image(s). The coordinate space for this set of related images shall be the same, which is indicated by having a single value for the attribute Frame of Reference UID (0020,0052). For CT images the slice images shall have the value AXIAL in the attribute Image Type, and the localizer image the value LOCALIZER. For MR images no specific value for image type is used to further qualify the relationship between plan and related slice images. The Acquisition Modality shall not use the method of burning-in localizer lines in the pixel sample values (pixel sample value is the "bits stored" part of the pixel data) of the localizer or plan image(s).

Image Display Actors that want to show the localizer lines will be able to calculate the position of these lines of intersection (if visible) based on the information recorded in the images by the Acquisition Modality.

4115 **4.8.4.1.2.2 Storage of NM Images (NMI)**

Systems supporting the NM Image Profile are required to support a number of attributes as described in the following tables and text. Although many of these attributes are Type 2 or Type 3 in DICOM, attributes indicated with R+ shall be present and shall have a value.

4120 This section is referred to in the Creator Images Stored [RAD-18] transaction and so the Evidence Creator may also be referred to in the text here.

**Table 4.8-2: Required Attributes in Nuclear Medicine Images**

Attribute	Tag	Image Type									
		General					Cardiac				
		STATIC	DYNAMIC	WHOLE BODY	GATED	TOMO	RECON TOMO	TOMO	RECON TOMO	GATED TOMO	RECON GATED TOMO
Detector Information Sequence	(0054,0022)										
> Image Position	(0020,0032)					R+		R+		R+	
> Image Orientation	(0020,0037)					R+	R+	R+	R+	R+	
> View Code Sequence	(0054,0220)										
>> Code Value	(0008,0100)			R+				R <sup>+</sup>		R <sup>+</sup>	

Attribute	Tag	Image Type									
		General					Cardiac				
		STATIC	DYNAMIC	WHOLE BODY	GATED	TOMO	RECON TOMO	TOMO	RECON TOMO	GATED TOMO	RECON GATED TOMO
>> Coding Scheme Designator	(0008,0102)			R+					R <sup>+1</sup>		R <sup>+1</sup>
Slice Progression Direction	(0054,0500)								R <sup>+2</sup>		R <sup>+2</sup>
Spacing Between Slices	(0018,0088)						R <sup>+4</sup>		R <sup>+4</sup>		R <sup>+4</sup>
Acquisition Context Sequence	(0040,0555)										
> Concept-Name Code Sequence	(0040,A043)							R <sup>+3</sup>	R <sup>+3</sup>	R <sup>+3</sup>	R <sup>+3</sup>
> Concept Code Sequence	(0040,A168)							R <sup>+3</sup>	R <sup>+3</sup>	R <sup>+3</sup>	R <sup>+3</sup>
Corrected Image	(0028,0051)						R <sup>+5</sup>		R <sup>+5</sup>		R <sup>+5</sup>
Patient orientation code sequence	(0054,0410)										
> Patient orientation modifier code sequence	0054,0412)					R+	R+	R+	R+	R+	R+
Frame of Reference UID	(0020,0052)					R+	R+	R+	R+	R+	R+

**Note 1:** Required for images from one of the standard cardiac views: Short Axis, Vertical Long Axis, or Horizontal Long Axis. For a definition of these terms and the implied orientation of the heart in the frame (refer to Nuclear Cardiology Nomenclature, Cequeria MD, et al, Journal of Nuclear Cardiology, 2002, 9:240-245).

The Code Values shall be taken from DICOM [CID 27](#). (Earlier versions of the Radiology Technical Framework contained the SNM3 equivalents of the codes in CID 27; those codes are now retired. See DICOM [PS3.16 Section 8.3](#) “Retired Codes and Expected Behavior”).

**Note 2:** Slice Progression Direction is required for Images in which the View Code Sequence indicates Short Axis views. The DICOM defined values are APEX\_TO\_BASE and BASE\_TO\_APEX.

**Note 3:** The Acquisition Context Module and the Acquisition Context Sequence (0040,0555) contained within it are required for cardiac stress/rest images. As defined in the DICOM Standard, the Concept Name Code Sequence (0040,A043) shall contain values from DICOM



4135 **CID 3101.** (Earlier versions of the Radiology Technical Framework contained an SRT code for “Resting State” and a DCM code for “Cardiac Stress State”. Those codes are now retired. See DICOM PS3.16 Section 8.3 “Retired Codes and Expected Behavior”.)

**Note 4:** The ‘Spacing Between Slices’ attribute is required by IHE to contain a valid value for the RECON image types.

4140 **Note 5:** Corrected Image (0028,0051) shall be present, with one of the values being ATTN, when storing attenuation corrected data. It may be present otherwise.

4145 It is recommended that when multiple energy windows are present that descriptive values be provided for the following attributes: Energy Window Name (0054,0018), Energy Window Lower Limit (0054,0014) and Energy Window Upper Limit (0054,0015).

If preferred window level settings based on activity within myocardial contours are known at the time of creation of cardiac short axis images, the information may be stored in Window Width (0028,1051) and Window Center (0028,1050). It is likely that use of presentation states will become the preferred method for storing this information in a future revision of the profile.

4150 It is recommended that when multiple detectors are present that descriptive values be provided in the codes contained in the View Code Sequence (0054,0220).

It is recommended that when multiple phases are present that descriptive values be provided for the Phase Description (0054,0039).

4155 The Acquisition Modality or Evidence Creator shall be capable of encoding the data for NM images with Image Type (0008,0008) equal to TOMO or GATED TOMO as if it were created on a single detector system. This means setting the Number of Detectors (0054,0021) to 1 and reordering the frame data to be consistent with acquisition by a single detector system regardless of the number of actual detectors used to acquire the image data. The system may additionally support encoding the data with the actual detector configuration.

4160 When the Image Type (0008,0008) is RECON TOMO or RECON GATED TOMO, the Image Position (0020,0032), Image Orientation (0020,0037), and the View Code Sequence (0054,0220) shall describe the orientation of the reconstructed frames within the Image.

4165 When the Image Type (0008,0008) is TOMO or RECON TOMO or GATED TOMO or RECON GATED TOMO, the Frame of Reference UID (0020,0052) Attribute shall be present with a value and describe the patient-relative frame of reference in which Image Position (Patient) (0020,0032) and Image Orientation (Patient) (0020,0037) are defined, for the purpose of allowing correlation with other images in the same frame of reference.

4170 When the Image Type (0008,0008) is WHOLE BODY, the useful image data is generally rectangular in shape (e.g., 256x1024). Acquisition Modalities and Evidence Creators shall be capable of creating these images without padding to create square frames.

Although the DICOM standard does not rigorously specify the order of frames in the image object, the following practice is commonly used and is required by the NM Image Profile:

4175 Images shall be stored with the frames sorted into “vector sorted order”. That is, the frames shall be ordered such that the frames are sorted first by the values of the first vector, then within a value for the first vector, the frames are sorted by the values of the second vector, etc. This order is referred to in this document as “vector sorted order”.

For details on vectors and examples of “vector sorted order”, refer to RAD TF-1x: Appendix E.4.2 NM Image IOD: Multi-Frames & Vectors.

#### 4.8.4.1.2.3 Storage of Full Field Digital Mammography Images

4180 When participating in the Modality Images Stored transaction and the Mammography Image Integration Profile, the Acquisition Modality that creates in vivo clinical full field digital mammography images, whether using a digital detector, by computed radiography, or by digitizing film, shall use the DICOM Digital Mammography X-Ray Image IOD, and shall supply the attributes with the additional requirements presented in Table 4.8.4.1.2.3-1.

4185 The less stringent requirements for Attributes for digitized film in Table 4.8.4.1.2.3-1 apply only if the intent of digitization is not for primary diagnosis, but for other purposes such as CAD and use as priors for comparison, since additional information otherwise required may not be obtainable at the time of digitization.

**Table 4.8.4.1.2.3-1: Required Additional Attributes in Mammography Images**

Attribute	Tag	DX, CR	Film	Rationale
Patient’s Name	(0010,0010)	R+	R+	Used for identification during display
Patient ID	(0010,0020)	R+	R+	Used for identification during display
Patient’s Birth Date	(0010,0030)	R+	O	Used for identification during display
Patient’s Age	(0010,1010)	R+	O	Used for identification during display
Acquisition Date	(0008,0022)	R+	R+	Used for identification during display
Acquisition Time	(0008,0032)	R+	O	Used for identification during display
Operator’s Name	(0008,1070)	R+	O	Used for identification during display
Manufacturer	(0008,0070)	R+	O	Used for quality control display
Institution Name	(0008,0080)	R+	O	Used for identification during display
Institution Address	(0008,0081)	R+	O	Used for quality control display
Manufacturer’s Model Name	(0008,1090)	R+	O	Used for quality control display
Device Serial Number	(0018,1000)	R+	O	Used for quality control display
Detector Type	(0018,7004)	R+	R+	Used to distinguish scanned film; Type 2 in DICOM, but in IHE MAMMO shall not be empty and shall contain a Defined Term provided in the standard
Detector ID	(0018,700A)	R+	O	Used for quality control display; this attribute in the Mammography IOD replaces the function in the CR IOD of Plate or Cassette ID for a CR mammography system

Attribute	Tag	DX, CR	Film	Rationale
Software Versions	(0018,1020)	R+	O	Used for CAD systems to be sure that processing is appropriate to the software version that created the images.
Station Name	(0008,1010)	R+	O	Used for identification of the system that acquired the images during display.
Gantry ID	(0018,1008)	RC+	O	Used for identification of the system that acquired the images during display. Required for images acquired by CR, since the Station Name (0008,1010) will normally identify the plate reader, not the acquisition device.
Source Image Sequence	(0008,2112)	R+	O	Needed to allow Image Displays to apply CAD marks to for presentation images when CAD was performed on for processing images
>Spatial Locations Preserved	(0028,135A)	R+	O	Needed to allow Image Displays to apply CAD marks to for presentation images when CAD was performed on for processing images; see also DICOM CP 564. Shall be YES if only a flip or rotation of the image pixel data has been performed.
KVP	(0018,0060)	R+	O	Used for display of the kVP technical factor
Exposure	(0018,1152)	R+	O	Used for display of the mAs technical factor
Exposure Time	(0018,1150)	R+	O	Used for display of the exposure time technical factor
Filter Material	(0018,7050)	R+	O	Used for display of the filter technical factor
Anode Target Material	(0018,1191)	R+	O	Used for display of the target technical factor
Compression Force	(0018,11A2)	R+	O	Used for display of the compression force technical factor
Body Part Thickness	(0018,11A0)	R+	O	Used for display of the compressed breast thickness technical factor
Positioner Primary Angle	(0018,1510)	R+	O	Used for display of the degree of obliquity technical factor
Relative X-ray Exposure	(0018,1405)	R+	O	Used for the display of the relative exposure technical factor. Note that Sensitivity (0018,6000) is NOT used for this purpose.
Entrance Dose in mGy	(0040,8302)	R+	O	Used for display of the estimated skin dose technical factor. Note that this attribute is used instead of the less precise (0040,0302) whose integer value is in dGy units.
Organ Dose	(0040,0316)	R+	O	Used for the display of the estimated mean glandular dose technical factor
VOI LUT Sequence	(0028,3010)	C	C	Required if Window Center and Width not present
>LUT Explanation	(0028,3003)	RC+	RC+	Required if more than one sequence item or at least one sequence item and window center/width pair is present in order to allow Image Display to present to the user a selection of LUTs or windows described by the explanation.
Window Center and Width Explanation	(0028,1055)	RC+	RC+	Required if more than one VOI LUT Sequence item or window center/width pair and at least one VOI

Attribute	Tag	DX, CR	Film	Rationale
				LUT Sequence item is present in order to allow Image Display to present to the user a selection of LUTs or windows described by the explanation.
VOI LUT Function	(0028,1056)	RC+	RC+	Required if Window Center and Width are not intended to be interpreted as parameters of a linear function in order to allow Image Display to perform appropriate contrast transformation. Enumerated Values LINEAR or SIGMOID. See DICOM CP 467.
Burned In Annotation	(0028,0301)	R	R	Shall have the enumerated value of “NO”, unless the image was obtained by film digitization.
Implant Present	(0028,1300)	R+	O	Used to control hanging and processing (including CAD); not identical to Implant Displaced value for View Modifier Code Sequence, since an implant may be present but not displaced.
Pixel Padding Value	(0028,0120)	RC+	RC+	Required if background air suppression has been performed by replacing the pixels with a value not used within the breast tissue, so that pixels with this value can be excluded from contrast transformations. May be present otherwise. See Section 4.8.4.1.2.3.2.
Pixel Padding Range Limit	(0028,0121)	RC+	RC+	Required if Pixel Padding Value (0028,0120) is present and the padding values are a range rather than a single value. See Section 4.8.4.1.2.3.2.
Estimated Radiographic Magnification Factor	(0018,1114)	R+	O	Used to adjust Imager Pixel Spacing (0018,1164) to account for geometric magnification for normal and magnified views when making distance measurements and displaying or printing calipers.
Date of Last Detector Calibration	(0018,700C)	RC+	O	Used for quality control display. Required if detector undergoes periodic calibration (e.g., may not be applicable for CR).

4190 See Section 2.2 “DICOM Usage Conventions”.

#### 4.8.4.1.2.3.1 Partial View Option

The Partial View Option requires that the Acquisition Modality always send a flag indicating whether or not the image is part of a set of images (a mosaic) used to cover the area of a breast that is larger than the detector, and which part of the set the image represents.

4195 The Partial View (0028,1350) attribute shall be sent and have a value of NO for magnification and spot compression images.

**Table 4.8.4.1.2.3.1-1: Required Additional Attributes in Mammography Images for the Partial View Option**

Attribute	Tag	IHE	Rationale
Partial View	(0028,1350)	R+	Required to control hanging of mosaics.
Partial View Code Sequence	(0028,1352)	RC+	Required if Partial View (0028,1350) has a value of YES, to control hanging of mosaics.

#### 4.8.4.1.2.3.2 Background Air Suppression

4200 For full field images (but not magnification or specimen images), the Acquisition Modality shall detect air outside the breast or the skin line, so as to provide for image contrast adjustment of the breast without adjusting the contrast of the background, and shall encode the region of the background to be excluded in “For Presentation” images by one of two means:

- 4205 • a single Pixel Padding Value (0028,0120) that is used to indicate a value in the pixel data that is outside the breast
- a range of pixel values between Pixel Padding Value (0028,0120) and Pixel Padding Range Limit (0028,0121) inclusive that is used to indicate values in the pixel data that are outside the breast

4210 The air suppression mechanism used shall not obscure any burned in lead markers present in the image.

#### 4.8.4.1.2.3.3 Cleavage Views

In a cleavage view that is not centered between both breasts or for which the operator designates one breast as primary, then the value of Image Laterality (0020,0062) shall be “L” or “R”, rather than “B”.

#### 4215 4.8.4.1.2.3.4 Digitized Film

The Digital Mammography X-Ray Image IOD, not the Secondary Capture Image IOD, shall be used for digitized film. Presentation Intent Type (0008,0068) shall be FOR PRESENTATION. Detector Type (0018,7004) shall be “FILM”.

4220 The values of the pixel size encoded in Imager Pixel Spacing (0018,1164) shall be the physical distance on the film being digitized or scanned between the center of each pixel.

The Study Date (0008,0020), Study Time (0008,0030), Acquisition Date (0008,0022) and Acquisition Time (0008,0022) shall be the date and time of acquisition of the film-screen exposure, not when the film was digitized.

4225 Burned In Annotation (0028,0301) shall be present and may have a value of YES if the digitized image contains patient identification information.

There are no specific requirements in this transaction for the reconciliation of identifiers during digitization. However, the Acquisition Modality may be grouped with an Importer in the Import Reconciliation Workflow Integration Profile.

4230 The output of the grayscale pipeline in a Digital Mammography X-Ray Image IOD FOR PRESENTATION image is always in P-Values; therefore, the optical density values obtained during film digitization shall be converted to P-Values, using appropriate assumed viewing conditions for the original film.

#### **4.8.4.1.2.4 Recording of X-Ray Dose Information**

4235 Acquisition Modality Actors claiming the Radiation Exposure Monitoring (REM) Profile shall record the Irradiation Event UID (0008,3010) of the event(s) that resulted in the data from which the image was derived in each image created; if the image or frame is derived from more than one irradiation event, multiple values shall be present (see DICOM CP 1090). The value(s) of the Irradiation Event UID shall match those encoded in the corresponding SR Dose Information instance. If the SR Dose Information instance is not being created by the equipment that actually administered the radiation, the equipment creating the SR Dose Information shall assure that all images contain the correct Irradiation Event UIDs.

4240 The Irradiation Event UIDs may be used to identify images corresponding to irradiation events for purposes such as identifying irradiated tissues and organs for dose mapping or for advanced effective dose estimations or for comparing the noise characteristics of the images with the dose.

4245 The Irradiation Event UIDs (0008,3010) shall be included in both original and derived images produced by the Acquisition Modality (such as retrospective reconstructions from the same raw data with different slice thickness or reconstruction intervals, multi-planar or 3D reconstructions from the same irradiation event, as well as for processing and for presentation projection images).

4250 For further information on Irradiation Events, see Section 4.62 Store Dose Information transaction, and RAD TF-1: 22 “Radiation Exposure Monitoring Profile”.

#### **4.8.4.1.2.5 Storage of Enhanced DICOM Objects**

This section is currently in the [CT/MR Perfusion Imaging with Contrast](#) (PERF) and [MR Diffusion Imaging](#) (DIFF) Trial Implementation Supplements.

#### **4.8.4.1.2.6 Intentionally Left Blank**

#### **4.8.4.1.2.7 Storage of Digital Breast Tomosynthesis Images**

The Acquisition Modality in the Digital Breast Tomosynthesis Profile shall support the DICOM Breast Tomosynthesis Image Storage SOP Class and the additional attributes specified in Table 4.8.4.1.2.7-2 and Table 4.8.4.1.2.7-3.

4260 If conventional 2D mammography images are acquired, the Acquisition Modality shall support the Digital Mammography X-Ray Image Storage - For Presentation and For Processing SOP Classes and the additional attributes specified in Table 4.8.4.1.2.3-1.

4265 The Acquisition Modality that supports the For Presentation Breast Projection X-Ray Images Option shall support the Breast Projection X-Ray Image For Presentation SOP Class and the additional attributes specified in Table 4.8.4.1.2.7-2 and Table 4.8.4.1.2.7.2-1.

The Acquisition Modality that supports the For Processing Breast Projection X-Ray Images Option shall support the Breast Projection X-Ray Image For Processing SOP Class and the additional attributes specified in Table 4.8.4.1.2.7-2 and Table 4.8.4.1.2.7.2-1.

4270 Note 1: These requirements are consistent with those for conventional 2D mammography images defined in Table 4.8.4.1.2.3-1, but specialized to account for the encoding of multiple frames in a single image instance and the use of multi-frame functional groups. The convention used in the CT/MR Perfusion Imaging with Contrast (PERF) Profile is used to indicate nesting within a functional group sequence.

4275 Note 2: Unlike the Digital Mammography X-Ray Image IOD, the Breast Tomosynthesis Image and Breast Projection X-Ray Image IODs use the Enhanced General Equipment Module, which already makes various equipment-related attributes mandatory, but these are repeated here for clarity.

Note 3: Since support for the Breast Projection X-Ray Image IOD is optional, additional requirements to include acquisition information in the Breast Tomosynthesis Image instances are to preserve the technique information for quality control.

4280 Acquisition Modalities capable of creating generated 2D images mathematically from tomosynthesis data (e.g., by Maximum Intensity Projection) shall encode them using the Breast Tomosynthesis Image Storage SOP Class.

4285 The Acquisition Modality is not required to use Stacks, or the Multi-frame Dimensions Module, but is not prohibited from doing so. Concatenations are forbidden. In order to distinguish the different types of tomosynthesis images, the Image Type (0008,0008) attribute shall be populated according to Table 4.8.4.1.2.7-1.

**Table 4.8.4.1.2.7-1: Image Type in Breast Tomosynthesis Images**

Type of tomosynthesis image	Image Type Value 1	Image Type Value 3	Image Type Value 4
Thin Slices	ORIGINAL/DERIVED	TOMOSYNTHESIS	NONE
Thick Slices (Slabs)	DERIVED	TOMOSYNTHESIS	e.g., MAXIMUM, MEAN
Tomosynthesis Generated 2D	DERIVED	TOMOSYNTHESIS	GENERATED_2D

Note: This table is adapted from DICOM CP 1342 and will be finalized after CP 1342 is approved.

**Table 4.8.4.1.2.7-2: Required additional attributes common to DBT Reconstruction and Project Images**

Attribute	Tag	Tomo	Proj	Rationale
Patient's Name	(0010,0010)	R+	R+	Used for identification during display
Patient ID	(0010,0020)	R+	R+	Used for identification during display
Patient's Birth Date	(0010,0030)	R+	R+	Used for identification during display
Patient's Age	(0010,1010)	R+	R+	Used for identification during display
Operators' Name	(0008,1070)	R+	R+	Used for identification during display
Manufacturer	(0008,0070)	R	R	Used for quality control display
Institution Name	(0008,0080)	R+	R+	Used for identification during display
Institution Address	(0008,0081)	R+	R+	Used for quality control display
Manufacturer's Model Name	(0008,1090)	R	R	Used for quality control display
Device Serial Number	(0018,1000)	R	R	Used for quality control display

Attribute	Tag	Tomo	Proj	Rationale
Station Name	(0008,1010)	R+	R+	Used for identification of the system that acquired the images during display

4290

**Table 4.8.4.1.2.7-3: Required Additional Attributes for DBT Reconstruction Images (Breast Tomosynthesis Image SOP Class)**

Attribute	Tag	Tomo	Rationale
Image Type	(0008,0008)	R	Used for display in order to distinguish between different reconstructions
Number of Frames	(0028,0008)	R	Used for display during scrolling
X-Ray 3D Reconstruction Sequence	(0018,9530)	RC+	Type 1 in Type U X-Ray 3D Reconstruction Module. Required if the image represents an additional reconstruction (e.g., slabs) Note: If the X-Ray 3D Reconstruction Sequence is sent, all other mandatory attributes need to be sent as well
>Reconstruction Description	(0018,9531)	RC+	Used to display the way how reconstructed images were generated. Shall be required for additional reconstructions (e.g., slabs)
Pixel Padding Value	(0028,0120)	RC+	Required if background air suppression has been performed by replacing the pixels with a value not used within the breast tissue, so that pixels with this value can be excluded from contrast transformations. May be present otherwise. See Section 4.8.4.1.2.3.2
Pixel Padding Range Limit	(0028,0121)	RC+	Required if Pixel Padding Value (0028,0120) is present and the padding values are a range rather than a single value. See Section 4.8.4.1.2.3.2
Breast Implant Present	(0028,1300)	R	Used to control hanging and processing; not identical to Implant Displaced value for View Modifier Code Sequence, since an implant may be present but not displaced
Frame VOI LUT With LUT Functional Macro (could either be in Per-frame Functional Groups Sequence (5200,9230) or in Shared Functional Groups Sequence (5200,9229) )			
Frame VOI LUT Sequence	(0028,9132)	R	
>VOI LUT Sequence	(0028,3010)	C	Required if Window Center and Width not present
>>LUT Explanation	(0028,3003)	RC+	Required if more than one sequence item or at least one sequence item and window center/width pair is present in order to allow Image Display to present to the user a selection of LUTs or windows described by the explanation
>Window Center	(0028,1050)	C	Required if VOI LUT Sequence is not present
>Window Width	(0028,1051)	C	Required if VOI LUT Sequence is not present



Attribute	Tag	Tomo	Rationale
>Window Center and Width Explanation	(0028,1055)	RC+	Required if more than one VOI LUT Sequence item or window center/width pair and at least one VOI LUT Sequence item is present in order to allow Image Display to present to the user a selection of LUTs or windows described by the explanation
>VOI LUT Function	(0028,1056)	RC+	Required if Window Center and Width are not intended to be interpreted as parameters of a linear function in order to allow Image Display to perform appropriate contrast transformation. Enumerated Values LINEAR or SIGMOID
Pixel Measures Functional Macro (could either be in Per-frame Functional Groups Sequence (5200,9230) or in Shared Functional Groups Sequence (5200,9229) )			
Pixel Measures Sequence	(0028,9110)	R	
>Pixel Spacing	(0028,0030)	RC	Required in order to perform measurements and annotations
>Slice Thickness	(0018,0050)	RC	Used for display
Plane Position (Patient) Functional Group Macro (may be in the Shared Functional Groups Sequence (5200,9229) if only a single frame is present, otherwise will be in the Per-frame Functional Groups Sequence (5200,9230) )			
Plane Position Sequence	(0020,9113)	R	
>Image Position (Patient)	(0020,0032)	R	Used to identify location of slice in volume Shall be different for every frame (i.e., one traversal of the volume)
Plane Orientation (Patient) Functional Group Macro (shall be in Shared Functional Groups Sequence (5200,9229) )			
Plane Orientation Sequence	(0020,9116)	R	
>Image Orientation (Patient)	(0020,0037)	R	Used for determination of the direction of rows and columns relative to the patient instead of Patient Orientation (0020,0020)
Frame Anatomy Functional Group Macro (shall be in Shared Functional Groups Sequence (5200,9229) )			
Frame Anatomy Sequence	(0020,9071)	R	
>Frame Laterality	(0020,9072)	R	Used to describe which breast is imaged; all frames share the same value
Information related to the acquisition of the source projection images			
Breast Tomosynthesis Contributing Sources			
Contributing Sources Sequence	(0018,9506)	R+	Type 1 in Type U Breast Tomosynthesis Contributing Sources Module

Attribute	Tag	Tomo	Rationale
>Detector ID	(0018,700A)	R	Used for quality control display
>Date of Last Detector Calibration	(0018,700C)	R	Used for quality control display
>Acquisition DateTime	(0008,002A)	R+	Used for identification during display
<b>Breast Tomosynthesis Acquisition</b>			
X-Ray 3D Acquisition Sequence	(0018,9507)	R+	Type 1 in Type U Breast Tomosynthesis Acquisition Module
>Source Image Sequence	(0008,2112)	RC	Used to identify breast projection X-Ray images that were used to generate this image
>KVP	(0018,0060)	R	Used for display of the kVp technical factor
>X-Ray Tube Current in mA	(0018,9330)	R	Used for display of the mA technical factor
>Filter Material	(0018,7050)	R	Used for display of the filter technical factor
>Anode Target Material	(0018,1191)	R	Used for display of the target technical factor
>Compression Force	(0018,11A2)	R	Used for display of the compression force technical factor
>Body Part Thickness	(0018,11A0)	R	Used for display of the compressed breast thickness technical factor
>Primary Positioner Scan Start Angle	(0018,9510)	R	Used for display of the degree of obliquity technical factor
>Primary Positioner Scan Arc	(0018,9508)	R	Used for display of the degree of obliquity technical factor
>Exposure in mAs	(0018,9332)	R	Used for display of the mAs technical factor
>Exposure Time in ms	(0018,9328)	R	Used for display of the exposure time technical factor
>Entrance Dose in mGy	(0040,8302)	R+	Used for display of the estimated skin dose technical factor  Note: This attribute is added in DICOM CP 1285 (final text)
>Organ Dose	(0040,0316)	R+	Used for the display of the estimated mean glandular dose technical factor  Note: This attribute is added in DICOM CP 1285 (final text)

Note: This table is not an exhaustive list of all attributes that are required by DICOM, but highlights those that are referred to elsewhere in the DBT Profile.

4295 Acquisition Modalities participating in the Digital Breast Tomosynthesis Profile may support the following transfer syntaxes as listed in Table 4.8.4.1.2.7-4 for all supported SOP Classes.

**Table 4.8.4.1.2.7-4: Compression Transfer Syntaxes in Digital Breast Tomosynthesis Profile**

Transfer Syntax UID	Name
1.2.840.10008.1.2.4.51	JPEG Extended (Process 2 & 4): Default Transfer Syntax for Lossy JPEG 12 Bit Image Compression (Process 4 only)
1.2.840.10008.1.2.4.57	JPEG Lossless, Non-Hierarchical (Process 14)
1.2.840.10008.1.2.4.70	JPEG Lossless, Non-Hierarchical, First-Order Prediction (Process 14)
1.2.840.10008.1.2.4.90	JPEG 2000 Image Compression (Lossless Only)
1.2.840.10008.1.2.4.91	JPEG 2000 Image Compression

**4.8.4.1.2.7.1 Partial View Option**

4300 Acquisition Modalities supporting the Partial View Option in the Digital Breast Tomosynthesis Profile shall fulfill all requirements listed in Section 4.8.4.1.2.3.1 for tomosynthesis reconstructions, 2D images, and projection images (if one of the Breast Project X-Ray Images Option is supported).

**4.8.4.1.2.7.2 Breast Projection X-Ray Images Options**

4305 The Acquisition Modality and Image Manager/Archive supporting the For Presentation Breast Projection X-Ray Images Option of the Digital Breast Tomosynthesis Profile shall additionally support the Breast Projection X-Ray Image For Presentation SOP Class as specified in Table 4.8.4.1.2.7-2 and in Table 4.8.4.1.2.7.2-1.

4310 The Acquisition Modality and Image Manager/Archive supporting the For Processing Breast Projection X-Ray Images Option of the Digital Breast Tomosynthesis Profile shall additionally support the Breast Projection X-Ray Image For Processing SOP Class as specified in Table 4.8.4.1.2.7-2 and in Table 4.8.4.1.2.7.2-1.

**Table 4.8.4.1.2.7.2-1: Required Additional Attributes for Breast Projection X-Ray Images**

Attribute	Tag	Proj	Rationale
Acquisition DateTime	(0008,002A)	R	Used for identification during display
Image Type	(0008,0008)	R	Used to indicate projection images
Detector ID	(0018,700A)	R+	Used for quality control display
Date of Last Detector Calibration	(0018,700C)	R+	Used for quality control display
Number of Frames	(0028,0008)	R	Used for display during scrolling
Patient Orientation	(0020,0020)	RC	Used for hanging protocol configuration- Pixel data orientation of the most representative frame
KVP	(0018,0060)	R	Used for display of the kVp technical factor
X-Ray Tube Current in mA	(0018,9330)	R+	Used for display of the mA technical factor

Attribute	Tag	Proj	Rationale
Exposure in mAs	(0018,9332)	R+	Used to display cumulative Exposure parameters
Exposure Time in ms	(0018,9328)	R+	Used to display cumulative Exposure parameters
Entrance Dose in mGy	(0040,8302)	R	Used for display of the collective total skin dose technical factor
Organ Dose	(0040,0316)	R	Used for the display of the collective total glandular dose technical factor
Anode Target Material	(0018,1191)	R	Used for display of the target technical factor
Compression Force	(0018,11A2)	R	Used for display of the compression force technical factor
Body Part Thickness	(0018,11A0)	R	Used for display of the compressed breast thickness technical factor
Pixel Padding Value	(0028,0120)	RC+	Required if background air suppression has been performed by replacing the pixels with a value not used within the breast tissue, so that pixels with this value can be excluded from contrast transformations. May be present otherwise. See Section 4.8.4.1.2.3.2
Pixel Padding Range Limit	(0028,0121)	RC+	Required if Pixel Padding Value (0028,0120) is present and the padding values are a range rather than a single value. See Section 4.8.4.1.2.3.2
Breast Implant Present	(0028,1300)	R	Used to control hanging and processing; not identical to Implant Displaced value for View Modifier Code Sequence, since an implant may be present but not displaced
X-Ray Filter Macro (could either be in Per-frame Functional Groups Sequence (5200,9230) or in Shared Functional Groups Sequence (5200,9229))			
X-Ray Filter Sequence	(0018,9556)	R+	Type 1 in Type U X-Ray Filter Macro
>Filter Material	(0018,7050)	R+	Used for display of the filter technical factor
Breast X-Ray Acquisition Dose Macro (could either be in Per-frame Functional Groups Sequence (5200,9230) or in Shared Functional Groups Sequence (5200,9229))			
X-Ray Acquisition Dose Sequence	(0018,9542)	R	
>Exposure in mAs	(0018,9332)	R	Used for display of the mAs technical factor
>Exposure Time in ms	(0018,9328)	R	Used for display of the exposure time technical factor
>Relative X-Ray Exposure	(0018,1405)	R+	Used for the display of the relative exposure technical factor
>Entrance Dose in mGy	(0040,8302)	R	Used for display of the estimated skin dose technical factor
>Organ Dose	(0040,0316)	R	Used for the display of the estimated mean glandular dose technical factor
Frame VOI LUT With LUT Functional Macro (could either be in Per-frame Functional Groups Sequence (5200,9230) or in Shared Functional Groups Sequence (5200,9229) )			

Attribute	Tag	Proj	Rationale
Frame VOI LUT Sequence	(0028,9132)	R	
>VOI LUT Sequence	(0028,3010)	C	Required if Window Center and Width not present
>>LUT Explanation	(0028,3003)	RC+	Required if more than one sequence item or at least one sequence item and window center/width pair is present in order to allow Image Display to present to the user a selection of LUTs or windows described by the explanation
>Window Center	(0028,1050)	C	Required if VOI LUT Sequence is not present
>Window Width	(0028,1051)	C	Required if VOI LUT Sequence is not present
>Window Center and Width Explanation	(0028,1055)	RC+	Required if more than one VOI LUT Sequence item or window center/width pair and at least one VOI LUT Sequence item is present in order to allow Image Display to present to the user a selection of LUTs or windows described by the explanation
>VOI LUT Function	(0028,1056)	RC+	Required if Window Center and Width are not intended to be interpreted as parameters of a linear function in order to allow Image Display to perform appropriate contrast transformation. Enumerated Values LINEAR or SIGMOID
Breast X-Ray Positioner Macro (could either be in Per-frame Functional Groups Sequence (5200,9230) or in Shared Functional Groups Sequence (5200,9229) )			
Positioner Position Sequence	(0018,9405)	R	
>Positioner Primary Angle	(0018,1510)	R	Used for display of the degree of obliquity technical factor
>Positioner Primary Angle Direction	(0018,9559)	R	Used for display of the degree of obliquity technical factor
Breast X-Ray Geometry Functional Macro (could either be in Per-frame Functional Groups Sequence (5200,9230) or in Shared Functional Groups Sequence (5200,9229) )			
X-Ray Geometry Sequence	(0018, 9476)	R	
>Estimated Radiographic Magnification Factor	(0018,1114)	R	Used to adjust Imager Pixel Spacing (0018,1164) to account for geometric magnification for normal and magnified views when making distance measurements and displaying or printing calipers
X-Ray Frame Pixel Data Properties Functional Group Macro (could either be in Per-frame Functional Groups Sequence (5200,9230) or in Shared Functional Groups Sequence (5200,9229) )			
Frame Pixel Data Properties Sequence	(0018,9443)	R	
>Imager Pixel Spacing	(0018,1164)	R+	Used for measurements

Attribute	Tag	Proj	Rationale
Frame Anatomy Functional Group Macro (shall be in Shared Functional Groups Sequence (5200,9229) )			
Frame Anatomy Sequence	(0020,9071)	R	
>Frame Laterality	(0020,9072)	R	Used to describe which breast is imaged; all frames share the same value
Derivation Image Macro (could either be in Per-frame Functional Groups Sequence (5200,9230) or in Shared Functional Groups Sequence (5200,9229) )			
Derivation Image Sequence	(0008,9124)	RC	Type 2 in Type C Derivation Image Macro
>Source Image Sequence	(0008,2112)	RC+	Used in “For Presentation” images to reference the corresponding “For Processing” images; shall have item(s) if “For Processing” images are produced as DICOM SOP instances

4315 The Acquisition Modality shall be capable of sending all supported SOP Classes to multiple destinations.

The Breast Projection X-Ray Image “For Presentation” instances shall contain a reference to the SOP Instance UID of the corresponding “For Processing” image in Source Image Sequence (0008,2112), if any.

#### 4.8.4.1.2.8 Enterprise Identity Option

4320 An Acquisition Modality supporting the Enterprise Identity Option shall copy values for the following Patient Context-critical attributes from the information received in the Modality Worklist, if provided, as specified in RAD TF-2x: Appendix A, to ensure consistency with the Performed Procedure Step object attributes, and the generated MPPS objects:

**Table 4.8.4.1.2.8-1: Patient Context Critical Attributes**

Patient Context-critical Attributes	Tag
Issuer of Patient ID	(0010,0021)
Issuer of Patient ID Qualifiers Sequence	(0010,0024)
>Universal Entity ID	(0040,0032)
>Universal Entity ID Type	(0040,0033)
Other Patient ID Sequence	(0010, 1002)
>Patient ID	(0010,0020)
>Issuer of Patient ID	(0010,0021)
>Issuer of Patient ID Qualifiers Sequence	(0010,0024)
>>Universal Entity ID	(0040,0032)
>>Universal Entity ID Type	(0040,0033)
>Type of Patient ID	(0010,0022)

4325

In the case where Issuer of Patient ID and Issuer of Patient ID Qualifiers Sequence attributes are not explicitly supplied by the DSS/Order Filler in the Modality Worklist (e.g., in the Unscheduled Case), the Acquisition Modality shall not include values for these attributes in the generated SOP Instances.

4330 Note: this requirement is intended to reduce complexity of information reconciliation on the Image Manager and Order Filler. An implementation that supports configuration of default values for these attributes will need to be configured, so that these defaults contain no value.

4335 An Acquisition Modality supporting the Enterprise Identity Option shall copy values for the following Accession Context-critical attributes from the information received in the Modality Worklist, if provided, as specified in RAD TF-2x: Appendix A to ensure consistency with the Performed Procedure Step object attributes, and the information included in the generated MPPS objects.

**Table 4.8.4.1.2.8-2: Accession Context Critical Attributes**

Accession Context-critical Attributes	Tag
Issuer of Accession Number Sequence	(0008,0051)
>Local Namespace Entity ID	(0040,0031)
>Universal Entity ID	(0040,0032)
>Universal Entity ID Type	(0040,0033)

**4.8.4.1.2.9 Intentionally Left Blank**

4340 **4.8.4.1.2.10 Recording of Radiopharmaceutical Administered Activity Information**

Acquisition Modality Actors claiming the Radiation Exposure for Nuclear Medicine (REM-NM) Profile shall copy the dose information, if present in the Radiopharmaceutical Radiation Dose SR object (RRDSR), into each created image instance (both original and derived) as shown in Table 4.8.4.1.2.10-1. The values from the SR Concepts in this table shall supersede any corresponding information the Acquisition Modality obtains from Query Modality Worklist [RAD-5].

4345

This requirement applies to both original and derived images produced by the Acquisition Modality (such as attenuation corrected and non-attenuation corrected images created from the same raw data, or retrospective reconstructions from the same raw data with different slice thickness or number of iterations).

4350 The Synchronization Module shall be included in PET and NM Images.

**Table 4.8.4.1.2.10-1: Mapping Radiopharmaceutical Dose Information to Images**

SR Concept	Attribute	RRDSR	NM IOD	PET IOD	Enhanced PET IOD
EV (F-61FDB, SRT, "Radiopharmaceutical agent")	Radiopharmaceutical Code Sequence (0054,0304)	Source-1	Copy-1	Copy-1	Copy-1
EV (C-10072, SRT, "Radionuclide")	Radionuclide Code Sequence (0054,0300)	Source-1	Copy-1	Copy-1	Copy-1

SR Concept	Attribute	RRDSR	NM IOD	PET IOD	Enhanced PET IOD
EV (123007, DCM, "Radiopharmaceutical Specific Activity")	Radiopharmaceutical Specific Activity (0018,1077)	Source-1	n.a.	Copy-1	Copy-1
EV (113503, DCM, "Radiopharmaceutical Administration Event UID")	Radiopharmaceutical Administration Event UID (0008,3012)	Source-1	Copy-1	Copy-1	Copy-1
EV (123003, DCM, "Radiopharmaceutical Start DateTime")	Radiopharmaceutical Start Time (0018,1072)	Source-1	Copy-1	Radiopharmaceutical Start Time (0018,1072) Radiopharmaceutical Start DateTime (0018,1078)	Radiopharmaceutical Start DateTime (0018,1078)
EV (123004, DCM, "Radiopharmaceutical Stop DateTime")	Radiopharmaceutical Stop Time (0018,1073)	Source-1	Copy-1	Radiopharmaceutical Stop Time (0018,1073) Radiopharmaceutical Stop DateTime (0018,1079)	Radiopharmaceutical Stop DateTime (0018,1079)
EV (113507, DCM, "Administered activity")	Radionuclide Total Dose (0018,1074)	Source-1	Copy-1	Copy-1 {convert MBq to Bq}	Copy-1
EV (123005, DCM, "Radiopharmaceutical Volume")	Radiopharmaceutical Volume (0018,1071)	Source-1	Copy-1	Copy-1	Copy-1
EV (G-C340, SRT, "Route of administration")	Radiopharmaceutical Route (0018,1070)	Source-1	Copy-1	Radiopharmaceutical Route (0018,1070) Administration Route Code Sequence (0054,0302)	Administration Route Code Sequence (0054,0302)
EV (8302-2, LN, "Patient Height")	Patient's Size (0010,1020)	Source-1	Copy-1	Copy-1	Copy-1
EV (29463-7, LN, "Patient Weight")	Patient's Weight (0010,1030)	Source-1	Copy-1	Copy-1	Copy-1
EV (14749-6, LN, "Glucose")	Acquisition Context Sequence (0040,0555) TID 3470 NM/PET Acquisition Context	Source-1	n.a.	Copy-1	Copy-1

4355 The Radiopharmaceutical Administration Event UID (0008,3012) may be used to identify images corresponding to radiopharmaceutical administration events for purposes such as identifying irradiated tissues and organs for dose mapping or for advanced effective dose estimations or for comparing the noise characteristics of the images with the dose.

For further information on Radiopharmaceutical Administration Events, see Section 4.110 Store Radiopharmaceutical Activity Information, and RAD TF-1: 40 REM for Nuclear Medicine Profile.

4360 When two or more radiopharmaceuticals are being imaged together, the same workflow applies, except that the RAS will have created an RRDSR for each radiopharmaceutical administered to the patient. The modality will need to retrieve all pertinent RRDSR objects from the Image



Manager/Archive. Each RRDSR will correspond to a unique subset of sequence Items in the Radiopharmaceutical Information Sequence encoded in the NM, PET or Enhanced PET IOD.

4365 **4.8.4.1.3 Expected Actions**

The Image Archive will store the received DICOM objects.

The DICOM objects shall be stored such that they can be later retrieved (see Section 4.16 Retrieve Images) in a fashion meeting the requirements defined for a DICOM Level 2 Storage SCP (Refer to DICOM [PS3.4 Section. B.4.1](#)).

4370 **4.8.4.1.3.1 DICOM Image Storage SOP Classes**

The DICOM Standard defines a number of image specific storage SOP classes. It is expected that Image Archive will support multiple storage SOP classes as defined in Table 4.8-1.

**Table 4.8-1: Suggested Image SOP Classes**

SOP Class UID	SOP Class Name
1.2.840.10008.5.1.4.1.1.1	Computed Radiography Image Storage
1.2.840.10008.5.1.4.1.1.2	CT Image Storage
1.2.840.10008.5.1.4.1.1.4	MR Image Storage
1.2.840.10008.5.1.4.1.1.20	Nuclear Medicine Image Storage
1.2.840.10008.5.1.4.1.1.128	Positron Emission Tomography Image Storage
1.2.840.10008.5.1.4.1.1.481.1	RT Image Storage
1.2.840.10008.5.1.4.1.1.7	Secondary Capture Image Storage
1.2.840.10008.5.1.4.1.1.6.1	Ultrasound Image Storage
1.2.840.10008.5.1.4.1.1.3.1	Ultrasound Multi-frame Image Storage
1.2.840.10008.5.1.4.1.1.12.1	X-Ray Angiographic Image Storage
1.2.840.10008.5.1.4.1.1.12.2	X-Ray Radiofluoroscopic Image Storage
1.2.840.10008.5.1.4.1.1.1.1	Digital X-Ray Image Storage – For Presentation
1.2.840.10008.5.1.4.1.1.1.1.1	Digital X-Ray Image Storage – For Processing
1.2.840.10008.5.1.4.1.1.1.2	Digital Mammography X-Ray Image Storage – For Presentation
1.2.840.10008.5.1.4.1.1.1.2.1	Digital Mammography X-Ray Image Storage – For Processing
1.2.840.10008.5.1.4.1.1.13.1.3	Breast Tomosynthesis Image Storage
1.2.840.10008.5.1.4.1.1.13.1.4	Breast Projection X-Ray Image Storage – For Presentation
1.2.840.10008.5.1.4.1.1.13.1.5	Breast Projection X-Ray Image Storage – For Processing
1.2.840.10008.5.1.4.1.1.1.3	Digital Intra-oral X-Ray Image Storage – For Presentation
1.2.840.10008.5.1.4.1.1.1.3.1	Digital Intra-oral X-Ray Image Storage – For Processing
1.2.840.10008.5.1.4.1.1.77.1.1	VL Endoscopic Image Storage
1.2.840.10008.5.1.4.1.1.77.1.2	VL Microscopic Image Storage
1.2.840.10008.5.1.4.1.1.77.1.3	VL Slide-Coordinates Microscopic Image Storage
1.2.840.10008.5.1.4.1.1.77.1.4	VL Photographic Image Storage

4375 Image Manager/Image Archives claiming the NM Image Profile are required to support all of the SOP classes listed in Table 4.8-3 below. Acquisition Modalities claiming the NM Image Profile are required to support Nuclear Medicine Image Storage.

**Table 4.8-3: Nuclear Medicine SOP Classes**

SOP Class UID	SOP Class Name
1.2.840.10008.5.1.4.1.1.20	Nuclear Medicine Image Storage
1.2.840.10008.5.1.4.1.1.7	Secondary Capture Image Storage
1.2.840.10008.5.1.4.1.1.7.2	Multi-frame Grayscale Byte Secondary Capture Image Storage
1.2.840.10008.5.1.4.1.1.7.4	Multi-frame True Color Secondary Capture Image Storage

Acquisition Modalities shall be capable of providing all created Nuclear Medicine image types using the Nuclear Medicine Image SOP class.

4380 Acquisition Modalities and Image Manager/Image Archives claiming the Mammography Image Profile are required to support all of the SOP classes listed in Table 4.8-4.

**Table 4.8-4: Mammography SOP Classes for Acquisition and Archival**

SOP Class UID	SOP Class Name
1.2.840.10008.5.1.4.1.1.1.2	Digital Mammography Image Storage – For Presentation
1.2.840.10008.5.1.4.1.1.1.2.1	Digital Mammography Image Storage – For Processing

4385 Film digitizers are only required to create “For Presentation” images. All other Acquisition Modalities claiming the Mammography Image Profile shall be capable of sending both “For Presentation” and “For Processing” images for every image stored, though not necessarily to the same target (e.g., “For Processing” images may be sent to the actor corresponding to the CAD device and “For Presentation” images or both to the Image Manager/Archive).

4390 The “For Presentation” images shall contain a reference to the SOP Instance UID of the corresponding “For Processing” image in Source Image Sequence (0008,2112).

The Image Manager/ Image Archive shall be able to accept both “For Processing” and “For Presentation” images from the Acquisition Modality, and make both available for retrieval, but is not required to be able to make “For Processing” images “presentable”.

4395 Acquisition Modalities and Image Manager/Image Archives participating in the Digital Breast Tomosynthesis Profile shall support the SOP classes with the optionality listed in Table 4.8-5.

**Table 4.8-5: Digital Breast Tomosynthesis SOP Classes for Acquisition and Archival**

SOP Class UID	SOP Class Name	Optionality (Acq. Mod)	Optionality (IM/IA)
1.2.840.10008.5.1.4.1.1.13.1.3	Breast Tomosynthesis Image Storage	R	R
1.2.840.10008.5.1.4.1.1.1.2	Digital Mammography X-Ray Image Storage – For Presentation	O	R

SOP Class UID	SOP Class Name	Optionality (Acq. Mod)	Optionality (IM/IA)
1.2.840.10008.5.1.4.1.1.1.2.1	Digital Mammography X-Ray Image Storage – For Processing	O	R
1.2.840.10008.5.1.4.1.1.13.1.4	Breast Projection X-Ray Image Storage – For Presentation (Note 1)	O	O
1.2.840.10008.5.1.4.1.1.13.1.5	Breast Projection X-Ray Image Storage – For Processing (Note 2)	O	O

Note 1: The Breast Projection X-Ray Image Storage – For Presentation SOP Class is required for Acquisition Modalities and Image Manager/Archives if the For Presentation Breast Projection X-Ray Image Option is supported.

4400 Note 2: The Breast Projection X-Ray Image Storage – For Processing SOP Class is required for Acquisition Modalities and Image Manager/Archives if the For Processing Breast Projection X-Ray Image Option is supported.

Image Manager/ Image Archives participating in the Digital Breast Tomosynthesis Profile shall support the compression transfer syntaxes as listed in Table 4.8.4.1.2.7-4 above.

#### 4.8.4.1.3.2 Enterprise Identity Option

4405 An Image Manager supporting the Enterprise Identity Option shall be capable of coercing the following Patient Context-critical attributes, when absent, to default values in the received SOP instances, before storing them:

Patient Context-critical Attributes	Tag
Issuer of Patient ID	(0010,0021)
Issuer of Patient ID Qualifiers Sequence	(0010,0024)
>Universal Entity ID	(0040,0032)
>Universal Entity ID Type	(0040,0033)

4410 Note: The Other Patient IDs Sequence (0010,1002) can contain additional identifiers (with issuer’s information) for the same patient. An Image Manager in a federated environment may be able to populate one or more entries in this sequence. This is permitted but not required.

An Image Manager supporting the Enterprise Identity Option shall be capable of coercing the following Accession Context-critical attributes, when absent, to default values in the received SOP instances before storing them:

Accession Context-critical Attributes	Tag
Issuer of Accession Number Sequence	(0008,0051)
>Local Namespace Entity ID	(0040,0031)
>Universal Entity ID	(0040,0032)
>Universal Entity ID Type	(0040,0033)

4415 An Image Manager supporting the Enterprise Identity Option shall be capable of coercing the following Institution Context-critical attributes, when absent, to default values in the received SOP instances before storing them:

<b>Institution Context-critical Attributes</b>	<b>Tag</b>
Institution Name	(0008,0080)
Institution Address	(0008,0081)
Institution Code Sequence	(0008,0082)
>Code Value	(0008,0100)
>Coding Scheme Designator	(0008,0102)
>Code Meaning	(0008,0104)

4420

## 4.9 Modality Presentation State Stored [RAD-9]

### 4.9.1 Scope

4425 This section describes DICOM Storage requests of Grayscale Softcopy Presentation States issued by the Acquisition Modality to the Image Archive. The Acquisition Modality sends Presentation States for storage along with the images so they can be later used for support of consistent display of imaging data

### 4.9.2 Actor Roles

**Actor:** Acquisition Modality

4430 **Role:** Generate Grayscale Softcopy Presentation States to be applied to image data. This actor will support the ability to send Presentation State data to an Image Archive.

**Actor:** Image Archive

**Role:** Accept and store Grayscale Softcopy Presentation State SOP Instances received from the Acquisition Modality.

### 4.9.3 Referenced Standards

4435 DICOM [PS3.4 Annex B](#): Storage Service Class

DICOM [PS3.4 Annex N](#): Grayscale Softcopy Presentation State Storage

DICOM [PS3.14](#): Grayscale Standard Display Function

### 4.9.4 Messages



4440

**Figure 4.9.4-1: Interaction Diagram**

#### **4.9.4.1 Modality Presentation State Stored**

##### **4.9.4.1.1 Trigger Events**

4445 The Acquisition Modality generates a Grayscale Softcopy Presentation State and sends it to the Image Archive for storage. A Presentation State shall be generated as part of a Performed Procedure Step (see Section 4.6.4). It can be either as part of a Simple, Unscheduled, Append, Discontinue or Grouped Cases for which the same requirements as images apply. When generated as part of a Presentation of Grouped Procedure Case it shall follow the specific requirements defined in Section 4.6.4.1.2.3.6.

##### **4.9.4.1.2 Message Semantics**

4450 The Acquisition Modality uses the DICOM C-STORE message to store Grayscale Softcopy Presentation States. All grayscale processing operations, and all spatial and graphical operations, that are relevant to the resulting presentation of the referenced image, have to be recorded in the presentation state. This will preserve the "as-last-seen" view of the image, with for example the contrast setting, rotation, flip and text annotation. The image operations in the presentation state override whatever is recorded in the image itself, even in the case that no attributes for a specific operation (e.g., Window Width/Window Level operation) are present in the presentation state. The latter case by definition specifies an identity operation. The full message semantics are defined in the Grayscale Softcopy Presentation State Storage SOP Class Behavior section of DICOM PS3.4. The Acquisition Modality will be the DICOM Storage SCU and the Image Archive will be the DICOM Storage SCP.

4455

4460

##### **4.9.4.1.3 Expected Actions**

The Image Archive will store the received Grayscale Softcopy Presentation State objects.

### **4.10 Storage Commitment [RAD-10]**

#### **4.10.1 Scope**

4465 After a Requester has sent images, Presentation States, Spatial Registration objects, Dose Objects, Evidence Documents or Key Image Notes, it requests that the Responder accept responsibility for them.

The objective of this transaction is to provide a formal release of storage responsibility to the Requester, allowing it to reuse its internal resources allocated to the study.

#### **4.10.2 Actor Roles**

4470 The roles in this transaction are defined in the following table and may be played by the actors shown here:

**Table 4.10.2-1 Actor Roles**

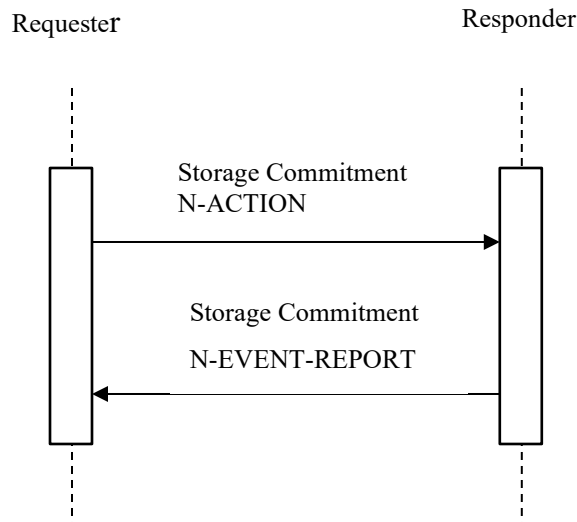
<b>Role:</b>	<b>Requester:</b> Requests a storage commitment from the Responder for DICOM objects previously transmitted.
<b>Actor(s):</b>	The following actors may play the role of Requester: Acquisition Modality Evidence Creator Importer Workitem Performer
<b>Role:</b>	<b>Responder:</b> Assumes responsibility for reliable storage, retrieval, and validity of the referenced DICOM objects.
<b>Actor(s):</b>	The following actors may play the role of Responder: Imager Manager/Archive Report Manager Report Repository

4475 Transaction text specifies behavior for each role. The behavior of specific actors may also be specified when it goes beyond that of the general role.

### 4.10.3 Referenced Standards

DICOM [PS3.4 Section J.3](#): Storage Commitment Push Model SOP Class.

#### 4.10.4 Messages



4480

**Figure 4.10.4-1: Interaction Diagram**

##### 4.10.4.1 Request Commitment Message

The Requester sends a request for storage commitment to the Responder.

###### 4.10.4.1.1 Trigger Events

The Requester successfully transferred one or more SOP Instances to the Responder.

4485

The Requester may make the request at any time after storage.

###### 4.10.4.1.2 Message Semantics

The message is an N-ACTION in the DICOM Storage Commitment Push Model SOP Class. The Requester is the SCU, and the Responder is the SCP.

4490

The Storage Commitment AE Title provided by the Responder may or may not be the same AE Title as the one provided for storing the referenced DICOM objects. The Requester shall support this flexibility with respect to the AE Title.

###### 4.10.4.1.3 Expected Actions

The Responder shall accept and process the N-ACTION request.

##### 4.10.4.2 Report Commitment Result Message

4495

The Responder reports the outcome of a request for storage commitment to the Requester.



#### 4.10.4.2.1 Trigger Events

The Responder determines the outcome (successful or unsuccessful) of a requested storage commitment.

4500      Note: There may be significant time between the Request Commitment Message and the Report Commitment Result Message.

#### 4.10.4.2.2 Message Semantics

The message is an N-EVENT-REPORT in the DICOM Storage Commitment Push Model SOP Class. The Responder is the SCU, the Requester is the SCP.

4505      The Responder determines the presence of and whether it accepts responsibility for the safe storage of the DICOM instances referenced in the request.

The N-EVENT-REPORT sent by the Responder may or may not occur on the same association as the N-ACTION request.

#### 4.10.4.2.3 Expected Actions

4510      With a successful result, ownership of data transfers from the Requester to the Responder, the Requester is then free to manage its own internal resources accordingly.

In the event that the Responder cannot service the storage commitment request, which can be determined by the "Failure Reason", it is expected that the Requester will neither delete nor modify the respective SOP instance(s).

4515      Note: A Requester may receive the Retrieve AE Title in a Storage Commitment Message (N-EVENT REPORT). However, this N-EVENT REPORT may happen well after a corresponding Modality Performed Procedure Step N-SET (Complete) was performed. For this reason, the IHE Radiology Technical Framework does not require that the Requester send the Retrieve AE Title Attribute (0008,0054) in the Modality and Creator Performed Procedure Step N-SET (see Sections 4.7 and 4.21).

4520

## 4.11 Image Availability Query [RAD-11]

### 4.11.1 Scope

4525 The purpose of this transaction is for the Department System Scheduler/Order Filler and Report Manager to determine whether SOP instances associated with a particular performed procedure step have been stored and are available for use in subsequent workflow steps as well as the storage location for retrieval of these SOP instances. The Image Manager is assumed to possess image availability information. The following examples show possible uses of the Image Availability Query:

- 4530 • The Department System Scheduler/Order Filler queries the Image Manager after receiving notification, that images have been acquired (by MPPS N-SET message with PPS status of “COMPLETED” – see transaction [RAD-7]) until it receives a list of all images listed in the PPS.
- 4535 • The Department System Scheduler/Order Filler needs to verify the availability of prior images pre-fetched according to workflow rules. In this case the availability of a single image may have to be verified.
- 4540 • The Report Manager queries the Image Manager after receiving notification, that images have been acquired (by MPPS N-SET message with PPS status of “COMPLETED” – see transaction [RAD-7]) until it receives a list of all images listed in the PPS. At this time the Report Manager may schedule the appropriate task so that the reporting process can commence.
- The Report Manager needs to verify the availability of prior images pre-fetched according to workflow rules. In this case the availability of a single image may have to be verified.

4545 Image availability is determined by the fact that the Image Instance UID in question is returned in response to the query. However, for the purposes of workflow management, image availability is generally qualified with additional parameters, such as:

*Storage Location* describes a system or system component (for instance, an Image Archive) that can be identified as a holder of images at a particular period in time.

4550 *Access Time* is a period of time that is required for images to be moved from a storage location to be ready for distribution; i.e., this does not take into consideration the outbound network transfer time or the performance of the receiver application to display the images. The exact access time is difficult to determine and is highly implementation-dependent. Nevertheless, it is possible to approximate access time by using a degree or level of image availability.

4555 **4.11.2 Actor Roles**

**Actor:** Department System Scheduler/Order Filler

**Role:** Queries Image Manager to determine availability of images for use in the processes according to department workflow (for example, interpretation)

**Actor:** Report Manager

4560 **Role:** Queries Image Manager to determine availability of images for use in the processes according to department workflow (for example, interpretation)

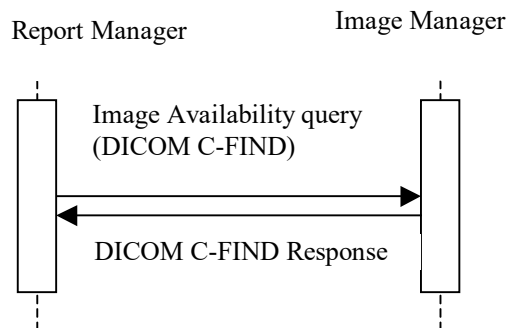
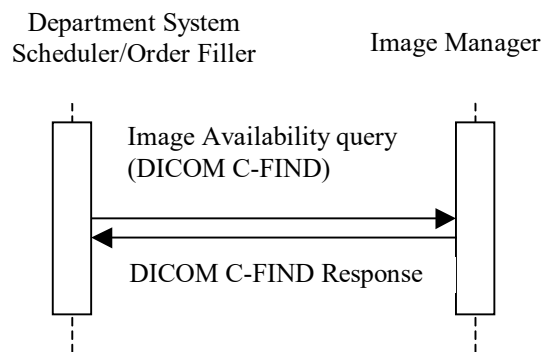
**Actor:** Image Manager

**Role:** Supplies image availability information to Department System Scheduler/Order Filler

**4.11.3 Referenced Standards**

4565 DICOM [PS3.4 Annex C](#): Query/Retrieve Service Class

**4.11.4 Messages**



4570

**Figure 4.11.4-1: Interaction Diagrams**

#### 4.11.4.1 Query Image Availability

##### 4.11.4.1.1 Trigger Events

4575 After receiving MPPS N-SET message with PPS status of “COMPLETED” or at a later time, the Department System Scheduler/Order Filler or Report Manager needs to verify image availability.

##### 4.11.4.1.2 Message Semantics

4580 The Department System Scheduler/Order Filler or Report Manager issues a C-FIND request as specified in the DICOM Standard for the Study Root Query/Retrieve Information Model – FIND SOP Class. The Department System Scheduler/Order Filler and Report Manager must be configured with the AE information of the Image Managers to be queried. To obtain the list of images in question, the Department System Scheduler/Order Filler and Report Manager shall perform a query on the Image Level based on the specification in DICOM. The Hierarchical Search Method shall be supported. The following table highlights important attributes of the query. It is not the intent of this transaction to provide a mechanism for polling. The Department System Scheduler/Order Filler and Report Manager shall query the Image Manager with the minimal number of queries necessary. For example, if the purpose is to verify availability of all images in a series, DSS/OF shall not send queries on an image-by-image basis. In this case, a single, zero length value for the SOP Instance UID could be sent, then all matched images information will be returned.

4590

**Table 4.11-1: Images Availability Query Keys**

Attribute	Tag	Query Key value
Query/Retrieve Level	(0008,0052)	IMAGE
Study Instance UID	(0020,000D)	Unique value for single-value match
Series Instance UID	(0020,000E)	Unique value for single-value match
SOP Instance UID	(0008,0018)	Single value, zero length value or list of UIDs

Per the DICOM standard, Retrieve AE Title (0008,0054) shall be supported and returned by the Image Manager as part of the response.

4595 To better quantify Access Time, the optional attribute Instance Availability (0008,0056) with enumerated values of “ONLINE”, “NEARLINE” and “OFFLINE” may be used. In terms of access times and results of subsequent Retrieve (C-MOVE) request, the Image Availability values shall be interpreted as follows:

**Table 4.11-2: Image Access Time**

Level	Description	Access time
ONLINE	Images can be retrieved from storage location and be ready for distribution within a reasonable period of time (what time is reasonable is implementation-specific)	Typically, seconds to a few minutes
NEARLINE	Before distribution, images have to be processed at a storage location; total retrieval time is longer than “reasonable”	Typically, minutes to an hour
OFFLINE	Image cannot be distributed without human user intervention	Typically, minutes to hours to days

#### **4.11.4.1.3 Expected Actions**

4600 The Image Manager shall respond to the C-FIND as specified in the DICOM standard, including returning the SOP Instance UIDs (0008,0018) and corresponding Retrieve AE title (0008,0054) when the match is successful.

## 4.12 Patient Update [RAD-12]

### 4.12.1 Scope

4605 This transaction involves changes to patient information, including demographics, patient identification, patient location/class changes, and patient merges. These changes may occur at any time for a patient record. This transaction is used for both inpatients (i.e., those who are assigned a bed at the facility) and outpatients (i.e., those who are not assigned a bed at the facility) if the patient has been previously registered.

### 4.12.2 Actor Roles

**Actor:** ADT

**Role:** Adds and modifies patient demographic and encounter information.

**Actor:** Order Placer

**Role:** Receives patient and encounter information for use in order entry.

4615 **Actor:** Department System Scheduler / Order Filler

**Role:** Receives and updates patient and encounter information to maintain consistency with the ADT system. Shall provide the updated patient and encounter information to the Image Manager.

**Actor:** Image Manager

4620 **Role:** Receives patient and encounter information for use in maintaining its database of images and other evidence documents and, possibly, for management such as auto-routing evidence objects to a specific in-patient floor.

**Actor:** Report Manager

**Role:** Receives patient and encounter information for use in maintaining its report database.

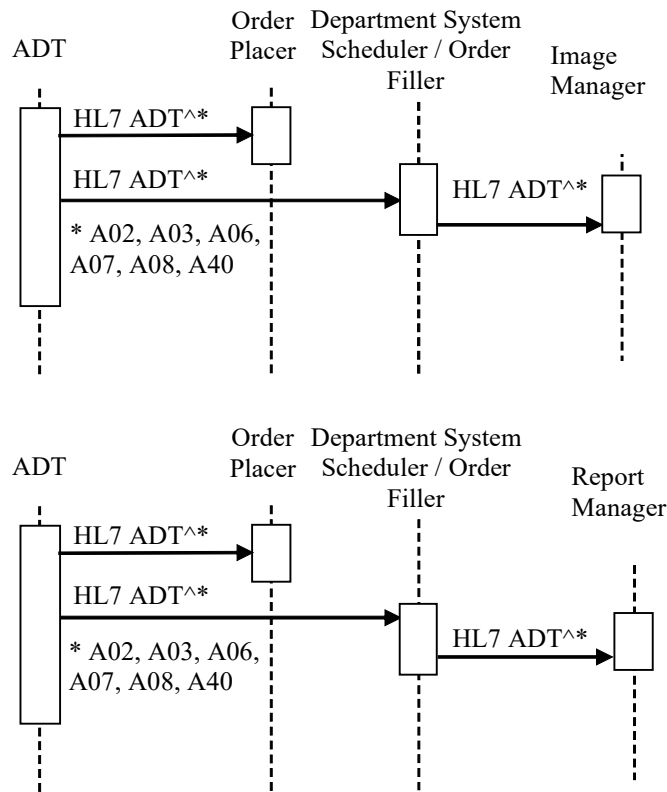
### 4.12.3 Referenced Standards

4625 HL7 v2.3.1 Chapters 2, 3

HL7 v2.5.1 Chapters 2, 3

ITI Technical Framework

## 4.12.4 Messages



4630

Figure 4.12.4-1: Interaction Diagrams

### 4.12.4.1 Patient Management – Patient Transfer

#### 4.12.4.1.1 Trigger Events

Changes in patient location result in the following Update Patient message:

4635

A02 – Patient Transfer

An A02 event is issued as a result of the patient changing his or her assigned physical location.

The message shall be generated by the system that performs the update whenever an error is resolved or a change occurs in patient location.

#### 4.12.4.1.2 Message Semantics

4640

The Update Patient transaction is an HL7 ADT message.

Message semantics are defined for both HL7 v2.3.1 and HL7 v2.5.1. The Profile and/or Options being claimed that incorporate this transaction will specify whether actors are required to support one, the other, or both sets of semantics.

**4.12.4.1.2.1 Message Semantics (HL7 v2.3.1)**

4645 The segments of the **Patient Transfer** message listed below are required, and the detailed description of messages is provided in the following subsections.

ADT A02	Patient Administration Message	Chapter in HL7 v2.3.1
MSH	Message Header	2
EVN	Event Type	3
PID	Patient Identification	3
PV1	Patient Visit	3

4650 Each message shall be acknowledged by the HL7 ACK message sent by the receiver of ADT message to its sender. See Section 2.4.3 “Acknowledgement Modes” for definition and discussion of the ACK message.

**4.12.4.1.2.1.1 MSH Segment (HL7 v2.3.1)**

MSH segment shall be constructed as defined in the Section 2.4.2.2 “Message Control”.

4655 Field *MSH-9 Message Type* shall have at least two components. The first component shall have a value of “ADT”; the second component shall have value of A02. The third component is optional; however, if present, it shall have a value of ADT\_A02.

**4.12.4.1.2.1.2 EVN Segment (HL7 v2.3.1)**

See Section 4.1.4.1.2.1.2 for required and optional fields of the EVN segment.

**4.12.4.1.2.1.3 PID Segment (HL7 v2.3.1)**

4660 Most of the fields in PID segment are optional, except those listed in Table 4.12-1. See Section 4.1.4.1.2.1.3 for the list of all fields of the PID segment.

**Table 4.12-1: IHE Profile - PID segment**

SEQ	LEN	DT	OPT	TBL#	ITEM#	ELEMENT NAME
3	20	CX	R		00106	Patient Identifier List
5	48	XPN	R		00108	Patient Name
18	20	CX	C		00121	Patient Account Number

*Adapted from the HL7 standard, version 2.3.1*

**4.12.4.1.2.1.4 PV1 Segment (HL7 v2.3.1)**

4665 Most of the fields in PV1 segment are optional, except those listed in Table 4.12-2. See Section 4.1.4.1.2.1.4 for the list of all fields of the PV1 segment.



**Table 4.12-2: IHE Profile - PV1 Segment**

SEQ	LEN	DT	OPT	TBL#	ITEM#	ELEMENT NAME
2	1	IS	R	0004	00132	Patient Class
3	80	PL	C		00133	Assigned Patient Location
6	80	PL	C		00136	Prior Patient Location
10	3	IS	R	0069	00140	Hospital Service
11	80	PL	C		00141	Temporary Location
19	20	CX	C		00149	Visit Number
43	80	PL	C		00173	Prior Temporary Location
51	1	IS	C	0326	01226	Visit Indicator

*Adapted from the HL7 standard, version 2.3.1*

4670 At least one of the fields *PID-18 Patient Account Number* or *PV1-19 Visit Number* shall be valued. Additional requirements for the presence of value in these fields may be documented in regional or national extensions to the IHE Radiology Technical Framework (see RAD TF-4).

Field *PV1-51 Visit Indicator* shall be valued with value “V” if the field *PV1-19 Visit Number* is present. May be omitted otherwise.

4675 The new patient location shall appear either in the field *PV1-3 Assigned Patient Location* or *PV1-11 Temporary Location* (if the transfer is to a temporary location). The old patient location shall appear in the field *PV1-6 Prior Patient Location* or *PV1-43 Prior Temporary Location* (if the transfer is from a temporary location).

#### 4.12.4.1.2.2 Message Semantics (HL7 v2.5.1)

The [RAD-12] Patient Management-Patient Transfer message is defined in the ITI Technical Framework as follows:

- 4680 • ADT^A02 Admit Patient in [ITI TF-2: 3.31.7.11 Patient Transfer \(ADT^A02^ADT\\_A02\)](#)

The segments listed below are required or conditionally required. All other segments are optional.

Segment	Meaning	Usage	Card.	HL7 chapter
MSH	Message Header	R	[1..1]	2
EVN	Event Type	R	[1..1]	3
PID	Patient Identification	R	[1..1]	3
PV1	Patient Visit	R	[1..1]	3
ROL	Role	R2	[0..*]	15
OBX	Observation/Result	C	[0..*]	7
ALI	Allergy Information	C	[0..*]	3

4685 The allergy segment AL1 shall be present if allergy information is added/updated. The OBX segment(s) shall be present if patient weight and/or height is updated.

Each message shall be acknowledged by the HL7 ACK message sent by the receiver of ADT message to its sender. See Section 2.4 for definition and discussion of the ACK message.

**4.12.4.1.2.2.1 MSH Segment (HL7 v2.5.1)**

4690 The MSH segment shall be constructed as defined in [ITI TF-2: 3.30.5.1](#) MSH – Header Segment. Additional specifications for actors complying with the Radiology Technical Framework are defined in Section 2.4.

Field *MSH-9-Message Type* shall have three components. The first component shall have a value of ADT; the second component shall have a value of A02; the third component shall have a value of ADT\_A02.

4695 **4.12.4.1.2.2.2 EVN Segment (HL7 v2.5.1)**

The EVN segment shall be constructed as defined in [ITI TF-2: 3.30.5.2](#) EVN – Event Type Segment.

**4.12.4.1.2.2.3 PID Segment (HL7 v2.5.1)**

4700 Most of the fields in the PID segment are optional, except those listed in Table 4.12-3. See [ITI TF-2: 3.30.5.3](#) for a list of all of the fields of the PID segment.

**Table 4.12-3: IHE Profile - PID segment**

SEQ	LEN	DT	OPT	TBL#	ITEM#	ELEMENT NAME
3	250	CX	R		00106	Patient Identifier List
5	250	XPN	R		00108	Patient Name
18	250	CX	C		00121	Patient Account Number

*Adapted from the HL7 standard, version 2.5.1*

**4.12.4.1.2.2.4 PV1 Segment (HL7 v2.5.1)**

4705 Most of the fields in the PV1 segment are optional, except those listed in Table 4.12-4. See [ITI TF-2: 3.30.5.4](#) for a list of all of the fields of the PV1 segment.

**Table 4.12-4: IHE Profile - PV1 Segment**

SEQ	LEN	DT	OPT	TBL#	ITEM#	ELEMENT NAME
2	1	IS	R	0004	00132	Patient Class
3	80	PL	C		00133	Assigned Patient Location
6	80	PL	C		00136	Prior Patient Location
10	3	IS	R	0069	00140	Hospital Service
11	80	PL	C		00141	Temporary Location
19	250	CX	C		00149	Visit Number

SEQ	LEN	DT	OPT	TBL#	ITEM#	ELEMENT NAME
43	80	PL	C		00173	Prior Temporary Location
51	1	IS	C	0326	01226	Visit Indicator

*Adapted from the HL7 standard, version 2.5.1*

Additional requirements for the presence of value in these fields may be documented in regional or national extensions to the IHE Radiology Technical Framework (see RAD TF-4).

4710 The PV1 segment shall be followed, for each of the consulting doctor(s), attending doctor, admitting doctor, and referring doctor, by a ROL segment.

Field *PV1-9-Consulting Doctor* shall not be present. The consulting doctor(s) are entirely described in the ROL segments.

4715 At least one of the fields *PID-18-Patient Account Number* or *PV1-19-Visit Number* shall be valued.

Field *PV1-51-Visit Indicator* shall be valued with value “V” if the field *PV1-19 Visit Number* is value. It may be omitted otherwise.

4720 The new patient location shall appear either in the field *PV1-3-Assigned Patient Location* or *PV1-11-Temporary Location* (if the transfer is to a temporary location). The old patient location shall appear in the field *PV1-6-Prior Patient Location* or *PV1-43-Prior Temporary Location* (if the transfer is from a temporary location).

#### 4.12.4.1.2.2.5 ROL Segment (HL7 v2.5.1)

4725 One ROL segment shall be included for each attending doctor, admitting doctor, referring doctor and consulting doctor, if any. Note that some Provider Role codes in the ROL Segment use the word "Provider" rather than "Doctor".

The ROL Segment shall be constructed as defined in [ITI TF-2: 3.30.5.6 ROL- Role Segment](#).

#### 4.12.4.1.3 Expected Actions

It is expected that after receiving Patient Transfer message (A02) the receiving system will change its records about patient location.

4730 It is the responsibility of the Image Manager and the Report Manager to ensure that the patient information (including the patient location) has been updated in the diagnostic reports and any relevant objects they manage when they are retrieved.

### 4.12.4.2 Patient Management – Update Patient Class

#### 4.12.4.2.1 Trigger Events

4735 Changes “in patient” class (that is from an inpatient status to outpatient, from an outpatient status to inpatient, from “admitted” or “non-admitted” status to discharged) result in one of the following Update Patient messages:

- A03 – Patient Discharge
- A06 – Change an Outpatient to an Inpatient
- A07 – Change an Inpatient to an Outpatient

4740

An A03 event signals the end of a patient’s stay in a healthcare facility. For in-patient, it signals that the patient’s status has changed to “discharged” and the patient is no longer in the facility. For outpatient, it signals the end of current visit of a patient to the facility. An A06 event is sent when a patient who was present for a non-admitted visit is being admitted. This event changes a patient’s status from non-admitted to “admitted”. An A07 event is sent when a patient who was admitted changes his/her status to “no longer admitted” but is still being seen for this episode of care. This event changes a patient from an “admitted” to a “non-admitted” status.

4745

#### 4.12.4.2.2 Message Semantics

Message semantics are defined for both HL7 v2.3.1 and HL7 v2.5.1. The Profile and/or Options being claimed that incorporate this transaction will specify whether actors are required to support one, the other, or both sets of semantics.

4750

##### 4.12.4.2.2.1 Message Semantics (HL7 v2.3.1)

The Update Patient transaction is an HL7 ADT message. The message shall be generated by the system that performs the update whenever patient class changes.

4755

The segments of the **Update Patient Class** messages listed below are required, and the detailed description of messages is provided in Sections 4.12.4.1.2.1.1 through 4.12.4.1.2.1.3.

ADT A03/A06/A07	Patient Administration Message	Chapter in HL7 v2.3.1
MSH	Message Header	2
EVN	Event Type	3
PID	Patient Identification	3
PV1	Patient Visit	3

Each message shall be acknowledged by the HL7 ACK message sent by the receiver of ADT message to its sender. See Section 2.4.3 “Acknowledgement Modes” for definition and discussion of the ACK message.

4760

##### 4.12.4.2.2.1.1 MSH Segment (HL7 v2.3.1)

MSH segment shall be constructed as defined in the Section 2.4.2.2 “Message Control”.

Field *MSH-9 Message Type* shall have at least two components. The first component shall have a value of “ADT”; the second component shall have value of A03, A06 or A07, as appropriate.

4765

The third component is optional; however, if present, it shall have a value of ADT\_A03 (for A03 message) or ADT\_A06 (for A06 and A07 messages).

**4.12.4.2.2.1.2 EVN Segment (HL7 v2.3.1)**

See Section 4.1.4.1.2.1.2 for required and optional fields of the EVN segment.

**4.12.4.2.2.1.3 PID Segment (HL7 v2.3.1)**

4770 Most of the fields in PID segment are optional, except those listed in Table 4.12-5. See Section 4.1.4.1.2.1.3 for the list of all fields of the PID segment.

**Table 4.12-5: IHE Profile - PID segment**

SEQ	LEN	DT	OPT	TBL#	ITEM#	ELEMENT NAME
3	20	CX	R		00106	Patient Identifier List
5	48	XPN	R		00108	Patient Name
18	20	CX	C		00121	Patient Account Number

*Adapted from the HL7 standard, version 2.3.1*

**4.12.4.2.2.1.4 PV1 Segment (HL7 v2.3.1)**

4775 Most of the fields in PV1 segment are optional, except those listed in Table 4.12-6. See Section 4.1.4.1.2.1.4 for the list of all fields of the PV1 segment.

**Table 4.12-6: IHE Profile - PV1 Segment**

SEQ	LEN	DT	OPT	TBL#	ITEM#	ELEMENT NAME
2	1	IS	R	0004	00132	Patient Class
3	80	PL	R		00133	Assigned Patient Location
6	80	PL	C		00136	Prior Patient Location
7	60	XCN	C	0010	00137	Attending Doctor
8	60	XCN	C	0010	00138	Referring Doctor
9	60	XCN	R2	0010	00139	Consulting Doctor
17	60	XCN	C	0010	00147	Admitting Doctor
19	20	CX	C		00149	Visit Number
43	80	PL	C		00173	Prior Temporary Location
51	1	IS	C	0326	01226	Visit Indicator

*Adapted from the HL7 standard, version 2.3.1*

4780 Additional requirements for the presence of value in these fields may be documented in regional or national extensions to the IHE Radiology Technical Framework (see RAD TF-4).

At least one of the fields *PID-18 Patient Account Number* or *PV1-19 Visit Number* shall be valued.

Field *PV1-51 Visit Indicator* shall be valued with value “V” if the field *PV1-19 Visit Number* is present. May be omitted otherwise.

4785 For “Discharge Patient” (A03) message:

- Field *PV1-3 Assigned Patient Location* shall contain the patient’s location prior to discharge.
- Field *PV1-45 Discharge Date/Time* does not have to be present in A03. If PV1-45 is not present then the timestamp in the EVN segment (*EVN-2 Recorded Date/Time*) signifies date and time of discharge.

4790

For “Change an Outpatient to an Inpatient” (A06) message:

- The new patient class shall appear in PV1-2-patient class.
- The new patient location shall appear in PV1-3-assigned patient location.
- The old patient location (if relevant) shall appear in PV1-6-prior patient location.
- The current active account number shall appear in PID-18-patient account number.
- The Attending Doctor in PV1-7, the Referring Doctor in PV1-8, and the Consulting Doctor in PV1-9, may be different, if there are changes to those values.

4795

For “Change an Inpatient to an Outpatient” (A07) message:

- The new patient class shall appear in PV1-2-patient class.
- The old patient location shall appear in PV1-6-prior patient location or *PV1-43 Prior Temporary Location*.
- The current active account number shall appear in field PID-18-patient account number.
- The Attending Doctor in PV1-7, the Referring Doctor in PV1-8, and the Consulting Doctor in PV1-9, may be different, if there are changes to those values.

4800

4805

A06 and A07 messages shall be used exclusively to send fields pertinent to the change in patient class between inpatient and outpatient.

Modification of any patient demographic information or non-patient-class visit information must be done by in addition sending an Update Patient Information (A08) message.

#### **4.12.4.2.2.2 Message Semantics (HL7 v2.5.1)**

4810

The messages that are used to implement the [RAD-12] Patient Management – Update Patient Class message are described in the following Sections:

- [ITI TF-2: 3.31.7.4](#) Discharge/End Visit (ADT^A03^ADT\_A03)
- [ITI TF-2: 3.31.7.9](#) Change an Outpatient to an Inpatient (ADT^A06^ADT\_A06)
- [ITI TF-2: 3.31.7.10](#) Change an Inpatient to an Outpatient (ADT^A07^ADT\_A06)

4815

The segments of the Update Patient Class message listed below are required or conditionally required. The detailed description of each segment is provided in the following subsections, including references to the corresponding ITI section, followed by additional requirements to comply with the IHE Radiology Technical Framework.

Segment	Meaning	Usage	Card.	HL7 chapter
MSH	Message Header	R	[1..1]	2
EVN	Event Type	R	[1..1]	3
PID	Patient Identification	R	[1..1]	3
PV1	Patient Visit	R	[1..1]	3
ROL	Role	R2	[0..*]	15
OBX	Observation/Result	C	[0..*]	7
AL1	Allergy Information	C	[0..*]	3

4820 The allergy segment AL1 shall be present if allergy information is added/updated. The OBX segment(s) shall be present if patient weight and/or height is updated.

Each message shall be acknowledged by the HL7 ACK message sent by the receiver of ADT message to its sender. See Section 2.4.4.3 “Acknowledgement Modes” for definition and discussion of the ACK message.

4825 **4.12.4.2.2.2.1 MSH Segment (HL7 v2.5.1)**

The MSH segment shall be constructed as defined in [ITI TF-2: 3.30.5.1](#) MSH – Header Segment. Additional specifications for actors conforming to the IHE Radiology Technical Framework are defined in Section 2.4.

4830 Field *MSH-9-Message Type* shall have three components. The first component shall have a value of ADT; the second component shall have a value of A03, A06, or A07, as appropriate; the third component shall have a value of ADT\_A03 (for A03 message) or ADT\_A06 (for A06 and A07 messages).

**4.12.4.2.2.2.2 EVN Segment (HL7 v2.5.1)**

4835 The EVN segment shall be constructed as defined in [ITI TF-2: 3.30.5.2](#) EVN – Event Type Segment.

**4.12.4.2.2.2.3 PID Segment (HL7 v2.5.1)**

Most of the fields in the PID segment are optional, except those listed in Table 4.12-7. See [ITI TF-2: 3.30.5.3](#) for a list of all of the fields of the PID segment.

**Table 4.12-7: IHE Profile - PID segment**

SEQ	LEN	DT	OPT	TBL#	ITEM#	ELEMENT NAME
3	250	CX	R		00106	Patient Identifier List
5	250	XP	R		00108	Patient Name
18	250	CX	C		00121	Patient Account Number

4840 *Adapted from the HL7 standard, version 2.5.1*

**4.12.4.2.2.4 PV1 Segment (HL7 v2.5.1)**

Most of the fields in the PV1 segment are optional, except those listed in Table 4.12-8. See [ITI TF-2: 3.30.5.4](#) for a list of all of the fields of the PV1 segment.

**Table 4.12-8: IHE Profile - PV1 Segment**

SEQ	LEN	DT	OPT	TBL#	ITEM#	ELEMENT NAME
2	1	IS	R	0004	00132	Patient Class
3	80	PL	R		00133	Assigned Patient Location
6	80	PL	C		00136	Prior Patient Location
7	250	XCN	C	0010	00137	Attending Doctor
8	250	XCN	C	0010	00138	Referring Doctor
9	250	XCN	X	0010	00139	Consulting Doctor
17	250	XCN	C	0010	00147	Admitting Doctor
19	250	CX	C		00149	Visit Number
43	80	PL	C		00173	Prior Temporary Location
51	1	IS	C	0326	01226	Visit Indicator

4845

*Adapted from the HL7 standard, version 2.5.1*

Additional requirements for the presence of value in these fields may be documented in regional or national extensions to the Radiology Technical Framework (see RAD TF-4).

At least one of the fields *PID-18-Patient Account Number* or *PV1-19-Visit Number* shall be valued.

4850 Field *PV1-51-Visit Indicator* shall be valued with value “V” if field *PV1-19-Visit Number* is valued. It may be omitted otherwise.

For the “Discharge Patient” (A03) message:

- Field *PV1-3-Assigned Patient Location* shall contain the patient’s location prior to discharge.

4855 • Field *PV1-45-Discharge Date/Time* does not have to be present in A03. If PV1-45 is not present then the timestamp in the EVN segment (*EVN-2-Recorded Date/Time*) signifies the date and time of discharge.

For “Change an Outpatient to an Inpatient” (A06) message:

- The new patient class shall appear in *PV1-2-patient class*.
- The new patient location shall appear in *PV1-3-assigned patient location*.
- The old patient location (if relevant) shall appear in *PV1-6-prior patient location*.
- The current active account number shall appear in *PID-18-patient account number*.
- *PV1-7-Attending Doctor* and *PV1-8-Referring Doctor* may be different, if there are changes to those values.



- 4865
- The Consulting Doctor, if changed, will be communicated in a ROL segment immediately following the PV1 segment.

For “Change an Inpatient to an Outpatient” (A07) message:

- 4870
- The new patient class shall appear in *PV1-2-patient class*.
  - The old patient location shall appear in PV1-6-prior patient location or PV1-43 Prior Temporary Location.
  - The current active account number shall appear in field *PID-18-patient account number*.
  - *PV1-7-Attending Doctor* and *PV1-8-Referring Doctor* may be different, if there are changes to those values.
- 4875
- The Consulting Doctor, if changed, will be communicated in a ROL segment immediately following the PV1 segment.

The PV1 segment shall be followed, for each of the attending doctor, admitting doctor, and referring doctor, by a ROL segment.

A06 and A07 messages shall be used exclusively to send fields pertinent to the change in patient class between inpatient and outpatient.

- 4880
- Modification of any patient demographic information or non-patient-class visit information must be done by sending a Patient Information Update message (see Section 4.12.4.3) in addition to the Update Patient Class message.

#### **4.12.4.2.2.5 ROL Segment (HL7 v2.5.1)**

- 4885
- One ROL segment shall be included for each attending doctor, admitting doctor, referring doctor and consulting doctor that is changed. Note that some Provider Role codes in the ROL Segment use the word "Provider" rather than "Doctor".

The ROL Segment shall be constructed as defined in [ITI TF-2: 3.30.5.6 ROL - Role Segment](#).

#### **4.12.4.2.3 Expected Actions**

- 4890
- It is expected that after receiving Patient Class Change message (A03/A06/A07), the receiving system will change its local patient visit information.

It is the responsibility of the Image Manager and the Report Manager to ensure that the patient information (including the patient location) has been updated in the diagnostic reports and any relevant objects they manage when they are retrieved.

#### **4.12.4.3 Patient Management – Patient Information Update**

- 4895
- ##### **4.12.4.3.1 Trigger Events**

Changes to patient demographics and account information (e.g., change in patient name, patient address, etc.) shall trigger the following Update Patient message:

- A08 – Update Patient Information

4900 The message shall be generated by the system that performs the update whenever an error is resolved or a change occurs in patient demographics.

#### 4.12.4.3.2 Message Semantics

The Update Patient transaction is an HL7 ADT message.

4905 All of the required (R and R2) information for a patient record shall be re-sent in an A08 message. Any information received as NULL (i.e., transmitted as two double quote marks “”) in the A08 message shall be removed from the receiving system's database for that patient record. If no value is sent (i.e., omitted) in the A08 message, the old value shall remain unchanged in the receiving system's database for that patient record.

4910 An A08 message is the only method that may be used to update patient demographic and visit information. However Patient ID cannot be updated with an A08 message. An A40 message shall be used for this purpose (see Section 4.12.4.4.2.1.5 for HL7 v2.3.1 or Section 4.12.4.4.2.2.5 for HL7 v2.5.1).

##### 4.12.4.3.2.1 Message Semantics (HL7 v2.3.1)

4915 The segments of the **Update Patient Information** message listed below are required, and the detailed description of the message is provided in Section 4.12.4.1.2.1.4. The allergy segment AL1 shall be present if allergy information is added/updated. OBX segment(s) shall be present if patient weight and/or height is updated.

ADT A08	Patient Administration Message	Chapter in HL7 v2.3.1
MSH	Message Header	2
EVN	Event Type	3
PID	Patient Identification	3
PV1	Patient Visit	3
[{OBX}]	Observation/results	7
[{AL1}]	Allergy	3

4920 Each message shall be acknowledged by the HL7 ACK message sent by the receiver of ADT message to its sender. See Section 2.4.3 “Acknowledgement Modes” for definition and discussion of the ACK message.

##### 4.12.4.3.2.1.1 MSH Segment (HL7 v2.3.1)

MSH segment shall be constructed as defined in the Section 2.4.2.2 “Message Control”.

4925 Field *MSH-9 Message Type* shall have at least two components. The first component shall have a value of “ADT”; the second component shall have value of A08. The third component is optional; however, if present, it shall have a value of ADT\_A08.

**4.12.4.3.2.1.2 EVN Segment (HL7 v2.3.1)**

See Section 4.1.4.1.2.1.2 for required and optional fields of the EVN segment.

**4.12.4.3.2.1.3 PID Segment (HL7 v2.3.1)**

4930 The required fields of the PID segment are listed in Table 4.12-9. All other fields are conditional and shall be present if the value of the field has been changed by the ADT. See Section 4.1.4.1.2.1.3 for the list of all fields of the PID segment.

Note that certain visit information, such as patient location and class may not be changed with this message. In these cases, **Patient Transfer** and **Change Patient Class** messages shall be used.

4935

**Table 4.12-9: IHE Profile - PID segment**

SEQ	LEN	DT	OPT	TBL#	ITEM#	ELEMENT NAME
3	20	CX	R		00106	Patient Identifier List
5	48	XP	R		00108	Patient Name
18	20	CX	C		00121	Patient Account Number

*Adapted from the HL7 standard, version 2.3.1*

**4.12.4.3.2.1.4 PV1 Segment (HL7 v2.3.1)**

Most of the fields in PV1 segment are optional, except those listed in Table 4.12-10. See Section 4.1.4.1.2.1.4 for the list of all fields of the PV1 segment.

4940

**Table 4.12-10: IHE Profile - PV1 Segment**

SEQ	LEN	DT	OPT	TBL#	ITEM#	ELEMENT NAME
2	1	IS	R	0004	00132	Patient Class
19	20	CX	C		00149	Visit Number
51	1	IS	C	0326	01226	Visit Indicator

*Adapted from the HL7 standard, version 2.3.1*

Additional requirements for the presence of value in these fields may be documented in regional or national extensions to the IHE Radiology Technical Framework (see RAD TF- 4).

4945 At least one of the fields *PID-18 Patient Account Number* or *PV1-19 Visit Number* shall be valued.

Field *PV1-51 Visit Indicator* shall be valued with value “V” if the field *PV1-19 Visit Number* is present. May be omitted otherwise.

**4.12.4.3.2.1.5 AL1 Segment (HL7 v2.3.1)**

See Section 4.1.4.1.2.1.5 for required and optional fields of the AL1 segment.

4950 **4.12.4.3.2.1.6 OBX Segment (HL7 v2.3.1)**

See Section 4.1.4.1.2.1.6 for required and optional fields of the OBX segment.

**4.12.4.3.2.2 Message Semantics (HL7 v2.5.1)**

The [RAD-12] Patient Management-Patient Information Update is defined in [ITI TF-2: 3.31.7.6 Patient Update Information \(ADT^A08^ADT\\_A01\)](#)

4955 The required segments of the **Patient Update Information** message are listed below. The detailed description of each segment is provided in the following subsections, including references to the corresponding ITI section, followed by additional requirements to comply with the IHE Radiology Technical Framework.

ADT A08	Patient Administration Message	Chapter in HL7 v2.5.1
MSH	Message Header	2
EVN	Event Type	3
PID	Patient Identification	3
PV1	Patient Visit	3
ROL	Role	15
[{OBX}]	Observation/results	7
[{AL1}]	Allergy	3

4960 The allergy segment AL1 shall be present if allergy information is added/updated. OBX segment(s) shall be present if patient weight and/or height is updated.

**4.12.4.3.2.2.1 MSH Segment (HL7 v2.5.1)**

The MSH segment shall be constructed as defined in [ITI TF-2: 3.30.5.1 MSH – Header Segment](#). Additional specifications for actors complying with the IHE Radiology Technical Framework are defined in Section 2.4.2.2 “Message Control”.

4965

Field *MSH-9-Message Type* shall have three components. The first component shall have a value of ADT; the second component shall have a value of A08; the third component shall have a value of ADT\_A08.

**4.12.4.3.2.2.2 EVN Segment (HL7 v2.5.1)**

4970 The EVN segment shall be constructed as defined in [ITI TF-2: 3.30.5.2 EVN – Event Type Segment](#).

**4.12.4.3.2.2.3 PID Segment (HL7 v2.5.1 Option)**

Most of the fields in the PID segment are optional, except those listed in Table 4.12-11. See [ITI TF-2: 3.30.5.3](#) for a list of all of the fields of the PID segment.

4975

**Table 4.12-11: IHE Profile - PID segment**

SEQ	LEN	DT	OPT	TBL#	ITEM#	ELEMENT NAME
3	250	CX	R		00106	Patient Identifier List
5	250	XPN	R		00108	Patient Name
18	250	CX	C		00121	Patient Account Number

*Adapted from the HL7 standard, version 2.5.1*

Note that certain visit information, such as patient location and class, may not be changed with this message. In these cases, Patient Transfer and Change Patient Class messages shall be used.

**4.12.4.3.2.2.4 PV1 Segment (HL7 v2.5.1)**

4980

All of the fields in the PV1 segment are optional, except those listed in Table 4.12-12. See Section 4.1.4.1.2.2.4 for a full discussion of the PV1 segment.

**Table 4.12-12: IHE Profile - PV1 Segment**

SEQ	LEN	DT	OPT	TBL#	ITEM#	ELEMENT NAME
2	1	IS	R	0004	00132	Patient Class
19	250	CX	C		00149	Visit Number
51	1	IS	C	0326	01226	Visit Indicator

*Adapted from the HL7 standard, version 2.5.1*

4985

At least one of the fields *PID-18-Patient Account Number* or *PVI-19-Visit Number* shall be valued. Additional requirements for the presence of value in these fields may be documented in regional or national extensions to the IHE Radiology Technical Framework (see RAD TF-4). It is required if it has been present in the registration message A01, A04 or A05 that is being cancelled by this message.

4990

Field *PVI-51-Visit Indicator* shall be valued with value “V” if the field *PVI-19-Visit Number* is valued. It may be omitted otherwise.

**4.12.4.3.2.2.5 OBX Segment (HL7 v2.5.1)**

See Section 4.1.4.1.2.2.6 for required and optional fields of the OBX segment.

**4.12.4.3.2.2.6 AL1 Segment (HL7 v2.5.1)**

See Section 4.1.4.1.2.2.7 for required and optional fields of the AL1 segment.

4995

**4.12.4.3.3 Expected Actions**

It is expected that after receiving Patient Information Update message (A08) the receiving system will update its local patient demographic, visit, allergy, and/or insurance information. Any information received as null in the new A08 message shall be removed locally.

5000

It is the responsibility of the Image Manager and the Report Manager to ensure that the patient information has been updated in the diagnostic reports and evidence objects (e.g., images, Key

Image Notes, Grayscale Softcopy Presentation States, Evidence Documents, etc.) they manage when they are retrieved from.

#### 4.12.4.4 Patient Management – Patient Merge

##### 4.12.4.4.1 Trigger Events

5005 When two patient records are found to identify the same patient and are merged, the following message shall be triggered:

- A40 – Merge Patient – Internal ID

5010 An A40 message indicates that a merge has been done at the internal identifier level. That is, PID-3 Patient ID identifier has been merged with MRG-1 Patient ID. This message is initiated by the system that performs the merge.

##### 4.12.4.4.2 Message Semantics

###### 4.12.4.4.2.1 Message Semantics (HL7 v2.3.1)

5015 The Update Patient transaction is an HL7 ADT message. The message shall be generated by the system that performs the update whenever Patient ID changes or two records are found to reference the same person.

The segments of the **Merge Patient** message listed below are required, and the detailed description of the message is provided in Section 4.12.4.1.2.1.5. The PV1 segment is optional.

ADT A40	Patient Administration Message	Chapter in HL7 v2.3.1
MSH	Message Header	2
EVN	Event Type	3
PID	Patient Identification	3
MRG	Merge Information	3
[PV1]	Patient Visit	3

5020 Each message shall be acknowledged by the HL7 ACK message sent by the receiver of ADT message to its sender. See Section 2.4.3 “Acknowledgement Modes” for definition and discussion of the ACK message.

###### 4.12.4.4.2.1.1 MSH Segment (HL7 v2.3.1)

MSH segment shall be constructed as defined in the Section 2.4.2.2 “Message Control”.

5025 Field *MSH-9 Message Type* shall have at least two components. The first component shall have a value of “ADT”; the second component shall have value of A40. The third component is optional; however, if present, it shall have a value of ADT\_A39.

**4.12.4.4.2.1.2 EVN Segment (HL7 v2.3.1)**

See Section 4.1.4.1.2.1.2 for required and optional fields of the EVN segment.

**4.12.4.4.2.1.3 PID Segment (HL7 v2.3.1)**

5030 Most of the fields in PID segment are optional, except those listed in Table 4.12-13. See Section 4.1.4.1.2.1.3 for the list of all fields of the PID segment.

**Table 4.12-13: IHE Profile - PID segment**

SEQ	LEN	DT	OPT	TBL#	ITEM#	ELEMENT NAME
3	20	CX	R		00106	Patient Identifier List
5	48	XPN	R		00108	Patient Name

*Adapted from the HL7 standard, version 2.3.1*

**4.12.4.4.2.1.4 PV1 Segment (HL7 v2.3.1)**

5035 Most of the fields in PV1 segment are optional, except those listed in Table 4.12-14. See Section 4.1.4.1.2.1.4 for the list of all fields of the PV1 segment.

**Table 4.12-14: IHE Profile - PV1 Segment**

SEQ	LEN	DT	OPT	TBL#	ITEM#	ELEMENT NAME
2	1	IS	R	0004	00132	Patient Class
11	80	PL	O		00141	Temporary Location

*Adapted from the HL7 standard, version 2.3.1*

**4.12.4.4.2.1.5 MRG Segment (HL7 v2.3.1)**

5040 The PID segment contains the dominant patient information, including Patient ID (and Issuer of Patient ID). The MRG segment identifies the “old” or secondary patient records to be de-referenced. HL7 does not require that the “old” record be deleted; it does require that the "incorrect" identifier not be referenced in future transactions following the merge.

**Table 4.12-15: IHE Profile - MRG segment**

SEQ	LEN	DT	OPT	TBL#	ITEM#	ELEMENT NAME
1	20	CX	R		00211	Prior Patient Identifier List
2	20	CX	O		00212	Prior Alternate Patient ID
3	20	CX	O		00213	Prior Patient Account Number
4	20	CX	R2		00214	Prior Patient ID
5	20	CX	O		01279	Prior Visit Number
6	20	CX	O		01280	Prior Alternate Visit ID
7	48	XPN	R2		01281	Prior Patient Name

5045

*Adapted from the HL7 Standard, version 2.3.1*

---

5050 A separate merge message shall be sent for each patient record to be merged. For example, if Patients A, B, and C are all to be merged into Patient B, two MRG messages would be sent. In the first MRG message patient B would be identified in the PID segment and Patient A would be identified in the MRG segment. In the second MRG message, patient B would be identified in the PID segment, and Patient C would be identified in the MRG segment. The visits and accounts of patients A and C will now belong to patient B’s record along with B’s original visits and accounts.

5055 Modification of any patient demographic information shall be done by sending a separate Update Patient Information (A08) message for the current Patient ID. An A40 message is the only method that may be used to update a Patient ID.

A new Patient shall be created in the Image Manager and the Report Manager using the demographics contained in the Patient Merge (A40) message when the prior Patient to be merged does not exist on the Image Manager. This shall be followed by a Patient Update (A08) Message to update any of the demographics missing in the Patient Merge (A40) message.

5060 **4.12.4.4.2.2 Message Semantics (HL7 v2.5.1)**

The [RAD-12] Patient Merge message is defined in [ITI TF-2: 3.31.7.31 Merge Two Patients \(ADT^A40^ADT\\_A39\)](#)

**4.12.4.4.2.2.1 MSH Segment (HL7 v2.5.1)**

5065 The MSH segment shall be constructed as defined in [ITI TF-2: 3.30.5.1 MSH – Header Segment](#). Additional specifications for actors complying with the IHE Radiology Technical Framework are defined in Section 2.4.

Field *MSH-9-Message Type* shall have three components. The first component shall have a value of ADT; the second component shall have a value of A40; the third component shall have a value of ADT\_A39.

5070 **4.12.4.4.2.2.2 EVN Segment (HL7 v2.5.1)**

The EVN segment shall be constructed as defined in [ITI TF-2: 3.30.5.2 EVN – Event Type Segment](#).

**4.12.4.4.2.2.3 PID Segment (HL7 v2.5.1)**

5075 Most of the fields in the PID segment are optional, except those listed in Table 4.12-16. See [ITI TF-2: 3.30.5.3](#) for a list of all of the fields of the PID segment.

**Table 4.12-16: IHE Profile - PID segment**

SEQ	LEN	DT	OPT	TBL#	ITEM#	ELEMENT NAME
3	250	CX	R		00106	Patient Identifier List
5	250	XPN	R		00108	Patient Name

*Adapted from the HL7 standard, version 2.5.1*



**4.12.4.4.2.2.4 PV1 Segment (HL7 v2.5.1)**

5080 Most of the fields in the PV1 segment are optional, except those listed in Table 4.12-17. See [ITI TF-2: 3.30.5.4](#) for a list of all of the fields of the PV1 segment.

**Table 4.12-17: IHE Profile - PV1 Segment**

SEQ	LEN	DT	OPT	TBL#	ITEM#	ELEMENT NAME
2	1	IS	R	0004	00132	Patient Class
11	80	PL	O		00141	Temporary Location

*Adapted from the HL7 standard, version 2.5.1*

**4.12.4.4.2.2.5 MRG Segment (HL7 v2.5.1)**

5085 The PID segment contains the dominant patient information, including Patient ID (and Issuer of Patient ID). The MRG segment identifies the “old” or secondary patient records to be de-referenced. HL7 does not require that the “old” record be deleted; it does require that the “incorrect” identifier not be referenced in future messages following the merge.

**Table 4.12-18: IHE Profile - MRG segment**

SEQ	LEN	DT	OPT	TBL#	ITEM#	ELEMENT NAME
1	250	CX	R		00211	Prior Patient Identifier List
2	250	CX	O		00212	Prior Alternate Patient ID
3	250	CX	O		00213	Prior Patient Account Number
4	250	CX	R2		00214	Prior Patient ID
5	250	CX	O		01279	Prior Visit Number
6	250	CX	O		01280	Prior Alternate Visit ID
7	250	XPN	R2		01281	Prior Patient Name

*Adapted from the HL7 Standard, version 2.5.1*

5090 A separate merge message shall be sent for each patient record to be merged. For example, if Patients A, B, and C are all to be merged into Patient B, two MRG messages would be sent. In the first MRG message patient B would be identified in the PID segment and Patient A would be identified in the MRG segment. In the second MRG message, patient B would be identified in the PID segment, and Patient C would be identified in the MRG segment. The visits and accounts of patients A and C will now belong to patient B’s record along with B’s original visits and accounts.

5095 Modification of any patient demographic information shall be done by sending a Patient Update Information (ADT^A08^ADT\_A01) message for the current Patient ID. An A40 message is the only method that may be used to update a Patient ID.

5100 A new Patient shall be created in the Image Manager and the Report Manager using the demographics contained in the Patient Merge (A40) message when the prior Patient to be merged does not exist on the Image Manager. This shall be followed by a Patient Update Information

(ADT^A08^ADT\_A01) message to update any of the demographics missing in the Patient Merge (A40) message.

5105 **4.12.4.4.3 Expected Actions**

It is expected that after receiving a Patient Merge message (A40) the receiving system will perform updates to reflect the fact that two patient records have been merged into a single record. If the correct target patient was not known to the receiving system, it is expected that the receiving system will create a patient record using the patient identifiers and demographics from the available PID segment data.

5110 It is the responsibility of the Image Manager and the Report Manager to ensure that the patient information has been updated in the diagnostic reports and evidence objects (e.g., images, Key Image Notes, Grayscale Softcopy Presentation States, Evidence Documents, etc.) they manage when they are retrieved.

5115 **4.12.4.5 Patient Management – Cancel Patient Transfer/Discharge**

**4.12.4.5.1 Trigger Events**

The following events will trigger one of the Cancel messages:

- A12 – Transfer of a patient from one location to another has been cancelled due to error in the information or the decision not to transfer the patient.
- A13 – Discharge of a patient has been cancelled due to error in the information or the decision not to discharge the patient.

5120

**4.12.4.5.2 Message Semantics**

5125 Patient Transfer/Discharge conveyed by the HL7 ADT^A02 or ADT^A03 messages may have to be revoked due to the errors in the information or the decision of not transferring/discharging patient. Cancellation transaction is conveyed by the HL7 ADT^A12 or ADT^A13 messages. ADT^A12 shall be used to revoke transaction conveyed by the ADT^A02 message. ADT^A13 shall be used to revoke the transaction conveyed by the ADT^A03 message.

Cancellation messages shall only be used if no other transactions were performed by the ADT on the patient record after the Patient Transfer/Discharge transaction was conveyed.

5130 Each message shall be acknowledged by the HL7 ACK message sent by the receiver of ADT message to its sender. See Section 2.4.3 “Acknowledgement Modes” for definition and discussion of the ACK message.

**4.12.4.5.2.1 Message Semantics (HL7 v2.3.1)**

5135 The segments of the message listed below are required, and their detailed descriptions are provided in subsections below. All other segments are optional.

Note: Additional qualifications to the level of specification and HL7 profiling are stated in Section 2.3.

ADT	Patient Administration Message	Chapter in HL7 2.3.1 and HL7 v2.5.1
MSH	Message Header	2
EVN	Event Type	3
PID	Patient Identification	3
PV1	Patient Visit	3

**4.12.4.5.2.1.1 MSH Segment (HL7 v2.3.1)**

MSH segment shall be constructed as defined in the Section 2.4.2.2 “Message Control”.

5140 Field *MSH-9 Message Type* shall have at least two components. The first component shall have a value of “ADT”; the second component shall have values of A12 or A13 as appropriate. The third component is optional; however, if present, it shall have a value of ADT\_A12 (for the A12 message) or ADT\_A01 (for A13 message).

**4.12.4.5.2.1.2 EVN Segment (HL7 v2.3.1)**

5145 See Section 4.1.4.1.2.1.2 for required and optional fields of the EVN segment.

**4.12.4.5.2.1.3 PID Segment (HL7 v2.3.1)**

All of the fields in PID segment are optional, except those listed in Table 4.12-19. See Section 4.1.4.1.2.1.3 for the list of all fields of the PID segment.

**Table 4.12-19: IHE Profile - PID segment**

SEQ	LEN	DT	OPT	TBL#	ITEM#	ELEMENT NAME
3	20	CX	R		00106	Patient Identifier List
5	48	XPN	R		00108	Patient Name
18	20	CX	C		00121	Patient Account Number

5150 *Adapted from the HL7 standard, version 2.3.1*

**4.12.4.5.2.1.4 PV1 Segment (HL7 v2.3.1)**

All of the fields in PV1 segment are optional, except those listed in Table 4.12-20. See Section 4.1.4.1.2.1.4 for the list of all fields of the PV1 segment.

**Table 4.12-20: IHE Profile - PV1 Segment**

SEQ	LEN	DT	OPT	TBL#	ITEM#	ELEMENT NAME
2	1	IS	R	0004	00132	Patient Class
19	20	CX	C		00149	Visit Number
51	1	IS	C	0326	01226	Visit Indicator

5155 *Adapted from the HL7 standard, version 2.3.1*

At least one of the fields *PID-18 Patient Account Number* or *PV1-19 Visit Number* shall be valued. Additional requirements for the presence of value in these fields may be documented in regional or national extensions to the IHE Radiology Technical Framework (see RAD TF- 4).

5160 Field *PV1-51 Visit Indicator* shall be valued with value “V” if the field *PV1-19 Visit Number* is present. May be omitted otherwise.

**4.12.4.5.2.2 Message Semantics (HL7 v2.5.1)**

For HL7 v2.5.1, the messages used to communicate the Cancel Patient Transfer/Discharge messages are described in the following sections in the ITI Technical Framework:

- [ITI TF-2: 3.31.7.12](#) Cancel Patient Transfer (ADT^A12^ADT\_A12)
- 5165 • [ITI TF-2: 3.31.7.5](#) Cancel Discharge/End Visit (ADT^A13^ADT\_A01)

**4.12.4.5.2.2.1 MSH Segment (HL7 v2.5.1)**

The MSH segment shall be constructed as defined in [ITI TF-2: 3.30.5.1](#) MSH – Header Segment. Additional specifications for actors complying with the IHE Radiology Technical Framework are defined in Section 2.4.

5170 Field *MSH-9-Message Type* shall have three components. The first component shall have a value of ADT. For the A12 message, the second component shall have a value of A12 and the third component shall have a value of ADT\_A09. For the A13 message, the second component shall have a value of A13 and the third component shall have a value of ADT\_A01.

**4.12.4.5.2.2.2 EVN Segment (HL7 v2.5.1)**

5175 The EVN segment shall be constructed as defined in [ITI TF-2: 3.30.5.2](#) EVN – Event Type Segment.

**4.12.4.5.2.2.3 PID Segment (HL7 v2.5.1)**

All of the fields in the PID segment are optional, except those listed in Table 4.12-21. See [ITI TF-2: 3.30.5.3](#) for a list of all of the fields of the PID segment.

5180 **Table 4.12-21: IHE Profile - PID segment**

SEQ	LEN	DT	OPT	TBL#	ITEM#	ELEMENT NAME
3	250	CX	R		00106	Patient Identifier List
5	250	XPN	R		00108	Patient Name
18	250	CX	C		00121	Patient Account Number

*Adapted from the HL7 standard, version 2.5.1*

**4.12.4.5.2.2.4 PV1 Segment (HL7 v2.5.1)**

Most of the fields in the PV1 segment are optional, except those listed in Table 4.12-22. See [ITI TF-2: 3.30.5.4](#) for a list of all of the fields of the PV1 segment.

5185

**Table 4.12-22: IHE Profile - PV1 Segment**

SEQ	LEN	DT	OPT	TBL#	ITEM#	ELEMENT NAME
2	1	IS	R	0004	00132	Patient Class
19	250	CX	C		00149	Visit Number
51	1	IS	C	0326	01226	Visit Indicator

*Adapted from the HL7 standard, version 2.5.1*

At least one of the fields *PID-18 Patient Account Number* or *PV1-19 Visit Number* shall be valued. Additional requirements for the presence of value in these fields may be documented in regional or national extensions to the IHE Radiology Technical Framework (see RAD TF-4).

5190 Field *PV1-51 Visit Indicator* shall be valued with value “V” if the field *PV1-19 Visit Number* is valued. It may be omitted otherwise.

#### **4.12.4.5.3 Expected Actions**

If the patient record was modified as a result of Patient Transfer/Discharge transaction, it shall be reverted.

5195

## 4.13 Procedure Update [RAD-13]

### 4.13.1 Scope

5200 This transaction involves changes to procedure information communicated from the Department System Scheduler to the Image Manager and Report Manager. Unlike the order message sent between the Order Placer and Order Filler (where only the order status can be updated without requiring a Cancel/New Order to change an order), the ORM or OMI message from the Department System Scheduler/Order Filler and Image Manager may reference a previously scheduled Requested Procedure identified by a Study Instance UID.

5205 The organization operating the DSS/OF and the Image Manager/Image Archive is responsible for synchronizing Procedure and Protocol Codes between all the systems that use such codes. IHE does not yet define a common mechanism for code synchronization or access.

### 4.13.2 Actor Roles

**Actor:** Department System Scheduler/Order Filler

5210 **Role:** Responsible for scheduling placed orders and sending the timing, resource, procedure and other information to the Image Manager.

**Actor:** Image Manager

**Role:** May use the scheduling, resource, procedure, and other information to perform image management tasks such as auto routing or pre fetching of images.

**Actor:** Report Manager

5215 **Role:** May use the scheduling, resource, procedure, and other information to perform detailed report scheduling tasks.

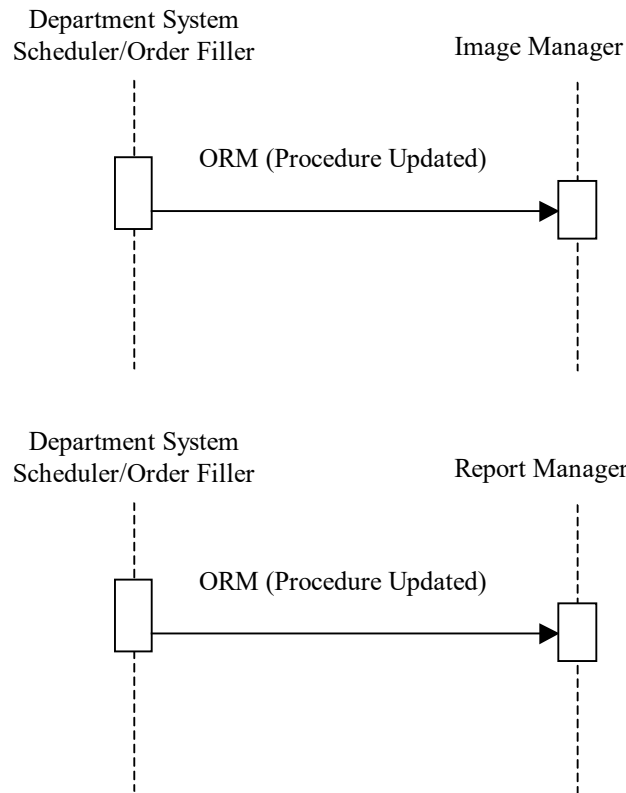
### 4.13.3 Referenced Standards

HL7 v2.3.1 Chapters 2, 4

HL7 v2.5.1 Chapters 2, 4

### 5220 4.13.4 Messages

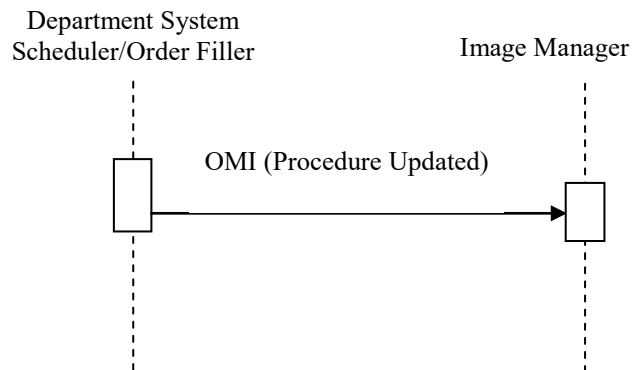
The following diagrams illustrate interactions between actors implementing HL7 v2.3.1:

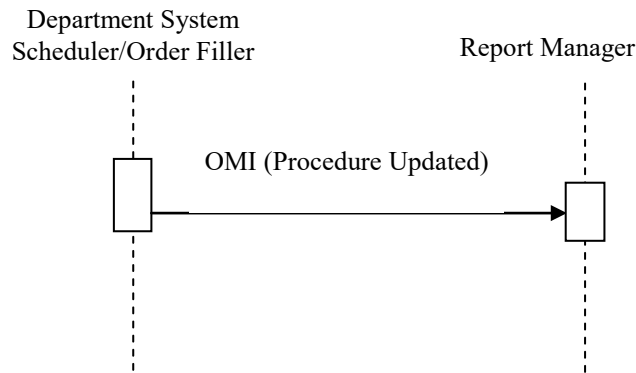


5225

**Figure 4.13.4-1: Interactions between actors implementing HL7 v2.3.1**

The following diagram illustrates interactions between actors implementing HL7 v2.5.1:





**Figure 4.13.4-2: Interactions between actors implementing HL7 v2.5.1**

5230 **4.13.4.1 Trigger Events**

A Procedure Update transaction is triggered in the case when the Department System Scheduler cancels, re-schedules or modifies characteristics of the procedure it previously scheduled and transmitted to the Image Manager and Report Manager via a Procedure Scheduled [RAD-4] transaction.

5235 **4.13.4.2 Message Semantics**

**4.13.4.2.1 Message Semantics (HL7 v2.3.1)**

The Procedure Update transaction is conveyed by the HL7 ORM message formatted according to the rules described in Section 4.4.

5240 The following Order Control Codes and Order Statuses are applicable for use in the *ORC-1* and *ORC-5* fields respectively.

**Table 4.13-1: IHE Profile - Required Order Control Codes and Order Statuses**

ORC-1 Value	ORC-1 Description	Originator	ORC-5 Value
CA	Cancel order request	DSS	CA
DC	Discontinue order request	DSS	CA
XO	Change order request, order is still scheduled or in progress	DSS	SC
XO	Change order request, order has been completed	DSS	CM

*Adapted from the HL7 Standard, version 2.3.1*

5245 The value of the field *ORC-5 Order Status* shall reflect status of the underlying order. If the order has been cancelled by either the Order Placer or the Order Filler, the value in the field *ORC-5* shall be set to 'CA'. In particular, if the field *ORC-1* is sent with the values of 'CA' or 'DC', the field *ORC-5* will be valued as 'CA'. If the order is changed and is still scheduled or in progress, *ORC-1* is set to 'XO' and *ORC-5* will be valued as 'SC'.



5250 If the order is changed and has been completed, *ORC-1* is set to ‘XO’ and *ORC-5* will be valued as ‘CM’. (This is done by the DSS/OF to update or synchronize procedure information with the IM/IA in the case the modality performed a procedure other than what was originally requested).

Only procedural information that is conveyed in the OBR and ORC segments of the message may be changed. Any updates of patient or visit information shall be performed by the Patient Update [RAD-12] transaction (see Sections 4.1 and 4.12 for PID and PV1 information and updates).

5255 All (ORC, OBR) segment pairs sent in the Procedure Scheduled message shall be present in the Procedure Update message, not only the pairs introducing a change.

The ORC and OBR elements given in Table 4.13-2 shall not be altered after the initial Procedure Scheduled (Section 4.4), regardless of the type of control code.

**Table 4.13-2: Procedure Update Elements that shall not be changed**

Element Name	Element Number(s)
Placer Order Number	OBR-2, ORC-2
Filler Order Number	OBR-3, ORC-3
Placer Group Number	ORC-4
Study Instance UID	ZDS-1

5260 Any other elements in the OBR or ORC segments may be changed when the Order Control Code = XO.

Note: Additional information regarding HL7 conventions, profiling, and implementation considerations are given in Section 2.3.

**4.13.4.2.2 Message Semantics (HL7 v2.5.1)**

5265 The Procedure Update message is conveyed by the HL7 OMI message formatted according to the rules described in Section 4.4.

The following Order Control Codes and Order Statuses are applicable for use in the *ORC-1* and *ORC-5* fields respectively.

**Table 4.13-3: IHE Profile - Required Order Control Codes and Order Statuses**

ORC-1 Value	ORC-1 Description	Originator	ORC-5 Value
CA	Cancel order request	DSS	CA
DC	Discontinue order request	DSS	CA
XO	Change order request, order is still scheduled or in progress	DSS	SC
XO	Change order request, order has been completed	DSS	CM

5270 *Adapted from the HL7 Standard, version 2.5.1*

5275 The value of field *ORC-5-Order Status* shall reflect the status of the underlying order. If the order has been cancelled by either the Order Placer or the Order Filler, the value in field ORC-5 shall be set to CA. In particular, if field ORC-1 is sent with a value of CA or DC, field ORC-5 shall be valued CA. If the order is changed and is still scheduled or in progress, ORC-1 shall be valued XO and ORC-5 shall be valued SC.

If the order is changed and has been completed, ORC-1 shall be valued XO and *ORC-5* shall be valued CM. (This is done by the DSS/OF to update or synchronize procedure information with the IM/IA in the case the modality performed a procedure other than what was originally requested.)

5280 Only procedural information that is conveyed in the OBR and ORC segments of the message may be changed. Any updates of patient or visit information shall be performed by the Patient Update [RAD-12] transaction (see Sections 4.1 and 4.12 for PID and PV1 information and updates).

5285 All ORC-TQ1-OBR-IPC segment groups sent in the Procedure Scheduled message shall be present in the Procedure Update message, not only the pairs introducing a change.

The ORC and OBR elements given in Table 4.13-4 shall not be altered after the initial Procedure Scheduled message (Section 4.4), regardless of the type of control code.

**Table 4.13-4: Procedure Update Elements that shall not be changed**

Element Name	Element Number(s)
Placer Order Number	OBR-2, ORC-2
Filler Order Number	OBR-3, ORC-3
Placer Group Number	ORC-4
Study Instance UID	IPC-3

5290 Any other elements in the OBR or ORC segments may be changed when the Order Control Code = XO.

Note: Additional information regarding HL7 conventions, profiling, and implementation considerations are given in Section 2.3.

#### 4.13.4.3 Expected Actions

5295 The Image Manager and Report Manager are expected to perform the following actions based on the value of the field *ORC-1 Order Control Code*:

5300 **CA** – Procedure has been cancelled, usually due to the cancellation of the underlying order; the Image Manager and the Report Manager shall inactivate corresponding procedure information using Study Instance UID as a unique key of the Requested Procedure in question. Information from PID and PV1 segments shall not be used to update patient or visit information. If the Department System Scheduler/Order Filler has been notified that a Performed Procedure Step is in progress for a Requested Procedure, the order control code DC shall be used.

**XO** – Procedure-related information (including scheduled date/time and/or resource) has been changed. The Image Manager and Report Manager shall modify corresponding procedure information using the Study Instance UID as a unique key of the procedure in question.  
5305 Information from PID and PV1 segments shall not be used to update patient or visit information.

**DC** – Order to which the particular procedure is related has been discontinued after at least one Performed Procedure Step for this procedure has started. The Image Manager and the Report Manager shall consider all remaining SPS known for that procedure (if any) cancelled. The Image Manager shall use the Study Instance UID as a unique key of the procedure in question.  
5310 Information from PID and PV1 segments shall not be used to update patient information.

## 4.14 Query Images [RAD-14]

### 4.14.1 Scope

The Image Display queries the Image Archive for study, series and image instances for retrieval.

### 4.14.2 Actor Roles

5315 **Actor:** Image Archive

**Role:** Responds to queries for Studies, Series, and Images.

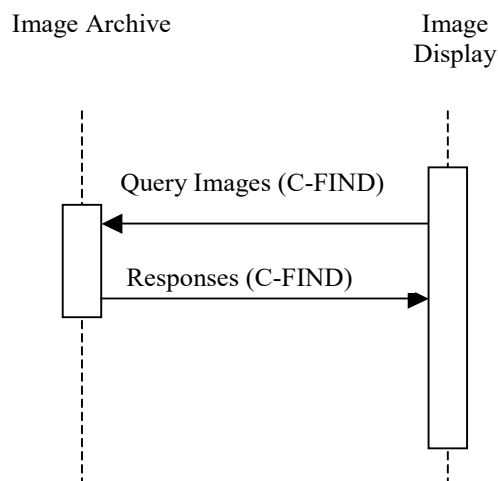
**Actor:** Image Display

**Role:** Issues Queries for Studies, Series, Images

### 4.14.3 Referenced Standards

5320 DICOM [PS3.4 Annex C](#): Query/Retrieve Service Class

### 4.14.4 Messages



**Figure 4.14.4-1: Interaction Diagram**

#### 4.14.4.1 Query Images

5325 The Query (Study Root – FIND and optionally Patient Root – FIND) SOP Classes shall be supported. Refer to DICOM [PS3.4 Annex C](#) for detailed descriptive semantics.

##### 4.14.4.1.1 Trigger Events

The user at the Image Display wishes to view selected images.

##### 4.14.4.1.2 Message Semantics

5330 The message semantics are defined by the DICOM Query/Retrieve SOP Classes.

A C-FIND Request from the DICOM Study Root Query/Retrieve Information Model – FIND SOP Class or optionally the DICOM Patient Root Query/Retrieve Information Model – FIND SOP Class shall be sent from the Image Display to the Image Archive. Hierarchical Search Method shall be supported.

5335 The Image Display (SCU) shall be able to perform at least Study and Series level queries. The Image Manager (SCP) shall support Study, Series, Composite Object Instance and Image Specific level queries.

The Image Display uses one or more matching keys as search criteria to obtain the list of matching entries in the Image Archive at the selected level (Patient & Study/Series/Image).

5340 Based on this list of entries, the Image Display may select relevant entries to be retrieved.

The matching keys and return keys to be supported by the Image Display (SCU) and the Image Manager (SCP) are defined in Table 4.14-1 and Table 4.14-2 below. The table includes the definition of return and matching keys specified by DICOM. The table specifies for both the Query SCU (Image Display) and the Query SCP (Image Archive) whether Matching Keys (keys used as matching criteria in the Query request) and Returned Keys (Keys used to request attributes to be returned in the query responses) are Required (R) or Optional (O). Requirements indicated with R+ or R+\* highlight the requirements added by the IHE Radiology Technical Framework. See Section 2.2 for more information on the notation in these tables.

**Table 4.14-1: Images Query Matching and Return Keys**

Attributes Name	Tag	Query Keys Matching		Query Keys Return		Notes
		SCU	SCP	SCU	SCP	
<b>Study Level</b>						
Study Date	(0008,0020)	R+	R	R+	R	
Study Time	(0008,0030)	R+	R	R+	R	
Accession Number	(0008,0050)	R+	R	R+	R	
Issuer of Accession Number Sequence	(0008,0051)	O	O	O	O	IHE-7, IHE-8
>Local Namespace Entity ID	(0040,0031)	O	O	O	O	IHE-7, IHE-8
>Universal Entity ID	(0040,0032)	O	O	O	O	IHE-7, IHE-8

IHE Radiology Technical Framework, Volume 2 (TF-2): Transactions

Attributes Name	Tag	Query Keys Matching		Query Keys Return		Notes
		SCU	SCP	SCU	SCP	
>Universal Entity ID Type	(0040,0033)	O	O	O	O	IHE-7, IHE-8
Patient Name	(0010,0010)	R+	R	R+	R	IHE-1, IHE-2
Patient ID	(0010,0020)	R+	R	R+	R	
Issuer of Patient ID	(0010,0021)	O	O	O	O	IHE-7, IHE-8
Issuer of Patient ID Qualifiers Sequence	(0010,0024)	O	O	O	O	IHE-7, IHE-8
>Universal Entity ID	(0040,0032)	O	O	O	O	IHE-7, IHE-8
>Universal Entity ID Type	(0040,0033)	O	O	O	O	IHE-7, IHE-8
Other Patient IDs Sequence	(0010,1002)	O	O	O	O	IHE-7, IHE-8
>Patient ID	(0010,0020)	O	O	O	O	IHE-7, IHE-8
>Issuer of Patient ID	(0010,0021)	O	O	O	O	IHE-7, IHE-8
>Issuer of Patient ID Qualifiers Sequence	(0010,0024)	O	O	O	O	IHE-7, IHE-8
>>Universal Entity ID	(0040,0032)	O	O	O	O	IHE-7, IHE-8
>>Universal Entity ID Type	(0040,0033)	O	O	O	O	IHE-7, IHE-8
>Type of Patient ID	(0010,0022)	O	O	O	O	IHE-7, IHE-8
Study ID	(0020,0010)	R+	R	R+	R	
Study Instance UID	(0020,000D)	R+*	R	R+*	R	IHE-5
Modalities in Study	(0008,0061)	R+	R+	R+	R+	
Referring Physician's Name	(0008,0090)	R+	R+	R+	R+	IHE-1, IHE-2
Study Description	(0008,1030)	O	O	O	O	IHE-6
Procedure Code Sequence	(0008,1032)					
>Code Value	(0008,0100)	O	O	O	O	
>Coding Scheme Designator	(0008,0102)	O	O	O	O	
>Coding Scheme Version	(0008,0103)	O	O	O	O	
>Code Meaning	(0008,0104)	O	O	O	O	
Name of Physician(s) Reading Study	(0008,1060)	O	O	O	O	IHE-1, IHE-2
Admitting Diagnoses Description	(0008,1080)	O	O	O	O	
Referenced Study Sequence	(0008,1110)					

IHE Radiology Technical Framework, Volume 2 (TF-2): Transactions

Attributes Name	Tag	Query Keys Matching		Query Keys Return		Notes
		SCU	SCP	SCU	SCP	
>Referenced SOP Class UID	(0008,1150)	O	O	O	O	
>Referenced SOP Instance UID	(0008,1155)	O	O	O	O	
Referenced Patient Sequence	(0008,1120)					
>Referenced SOP Class UID	(0008,1150)	O	O	O	O	
>Referenced SOP Instance UID	(0008,1155)	O	O	O	O	
Patient's Birth Date	(0010,0030)	O	O	R+	R+	
Patient's Birth Time	(0010,0032)	O	O	O	O	
Patient's Sex	(0010,0040)	O	O	R+	R+	
Other Patient IDs	(0010,1000)	O	O	O	O	
Other Patient Names	(0010,1001)	O	O	O	O	IHE-1, IHE-2
Patient's Age	(0010,1010)	O	O	O	O	
Patient's Size	(0010,1020)	O	O	O	O	
Patient's Weight	(0010,1030)	O	O	O	O	
Ethnic Group	(0010,2160)	O	O	O	O	
Occupation	(0010,2180)	O	O	O	O	
Additional Patient History	(0010,21B0)	O	O	O	O	
Patient Comments	(0010,4000)	O	O	O	O	
Other Study Numbers	(0020,1070)	O	O	O	O	
Number of Patient Related Studies	(0020,1200)	N/A	N/A	O	O	
Number of Patient Related Series	(0020,1202)	N/A	N/A	O	O	
Number of Patient Related Instances	(0020,1204)	N/A	N/A	O	O	
Number of Study Related Series	(0020,1206)	N/A	N/A	O	R+	
Number of Study Related Instances	(0020,1208)	N/A	N/A	O	R+	
Interpretation Author	(4008,010C)	O	O	O	O	IHE-1, IHE-2
<b>Series Level</b>						
Modality	(0008,0060)	R+	R	R+	R	
Series Number	(0020,0011)	R+	R	R+	R	
Series Instance UID	(0020,000E)	R+*	R	R+*	R	IHE-5
Number of Series Related Instances	(0020,1209)	N/A	N/A	O	R+	

Attributes Name	Tag	Query Keys Matching		Query Keys Return		Notes
		SCU	SCP	SCU	SCP	
Series Description	(0008,103E)	O	O	R+	R+	
Performed Procedure Step ID	(0040, 0253)	O	O	O	O	
Referenced Performed Procedure Step Sequence	(0008,1111)					
>Referenced SOP Class UID	(0008,1150)	O	O	O	O	
>Referenced SOP Instance UID	(0008,1155)	O	O	O	O	
Request Attribute Sequence	(0040, 0275)					IHE-3
>Requested Procedure ID	(0040,1001)	R+	R+	R+	R+	
>Scheduled Procedure Step ID	(0040,0009)	R+	R+	R+	R+	
Performed Procedure Step Start Date	(0040,0244)	R+	R+	R+	R+	
Performed Procedure Step Start Time	(0040,0245)	R+	R+	R+	R+	
Body Part Examined	(0018,0015)	O	O	O	O	
Institution Name	(0008,0080)	O	O	O	O	IHE-7, IHE-8
Institution Address	(0008,0081)	O	O	O	O	IHE-7, IHE-8
Institution Code Sequence	(0008,0082)	O	O	O	O	IHE-7, IHE-8
>Code Value	(0008,0100)	O	O	O	O	IHE-7, IHE-8
>Coding Scheme Designator	(0008,0102)	O	O	O	O	IHE-7, IHE-8
>Code Meaning	(0008,0104)	O	O	O	O	IHE-7, IHE-8
<b>Composite Object Instance Level</b>						
Instance Number	(0020,0013)	O	R	O	R	
SOP Instance UID	(0008,0018)	O	R	O	R	
SOP Class UID	(0008,0016)	O	R+	O	R+	IHE-4

5350

Table 4.14-2 extends the table above with image-specific keys.

**Table 4.14-2: Image Specific Query Matching and Return Keys**

Attribute Name	Tag	Query Keys Matching		Query Keys Return		Notes
		SCU	SCP	SCU	SCP	
<b>Image Specific Level</b>						
Rows	(0028,0010)	O	O	O	R+	

Attribute Name	Tag	Query Keys Matching		Query Keys Return		Notes
		SCU	SCP	SCU	SCP	
Columns	(0028,0011)	O	O	O	R+	
Bits Allocated	(0028,0100)	O	O	O	R+	
Number of Frames	(0028,0008)	O	O	O	R+	

5355 The SCP is required (R+) to support the query return key elements: Rows, Columns, Bits Allocated and Number of Frames for calculating the storage size needed for retrieving (storing) the images. Furthermore, the image Bits Allocated is used in matching the image pixel bit depth to the Hard Copy Device (Printer) pixel bit depth.

- **IHE-1:** Case insensitive matching is allowed for attributes of VR PN per DICOM.
- 5360 • **IHE-2:** SCUs are recommended to append wildcard “\*” at the end of each component of any structured name to facilitate matching (i.e., PN attributes).
- 5365 • **IHE-3:** Universal Matching (selecting return keys) against an Attribute of VR SQ, may be requested by the Query SCU using a Zero Length Sequence Attribute. Query SCPs shall accept such Universal Match Requests. In addition, Query SCPs are required by the DICOM Standard to support requests for a Universal Match for an SQ attribute encoded as a zero-length item.
- 5370 • **IHE-4:** A SOP Class UID is a non-ambiguous key to identify a specific type of image (Modality is not).
- 5370 • **IHE-5:** SCUs shall be able to include Study and Series UIDs as Matching Keys in queries. UID values will most probably originate from actor-internal logic that was performed prior to the Image Query, not from direct user input. For instance, an Image Display wants to display images of a series that is referenced in a DICOM Presentation State instance it just has retrieved - it includes the Series Instance UID value from the Presentation State as a query matching key.
- 5375 • **IHE-6:** Study Description as a Return Key shall be supported as R+ by SCUs and SCPs in the SWF.b Profile.
- 5380 • **IHE-7:** Image Displays that support the Enterprise Identity Option shall request Institution Name, Institution Address, Institution Code Sequence, Issuer of Accession Number Sequence, Issuer of Patient ID, Issuer of Patient ID Qualifiers Sequence and Other Patient IDs Sequence. See Section 4.14.4.1.2.1.
- **IHE-8:** Image Managers that support the Enterprise Identity Option shall provide the Institution Name, Institution Address, Institution Code Sequence, Issuer of Accession Number Sequence, Issuer of Patient ID, Issuer of Patient ID Qualifiers Sequence and Other Patient IDs Sequence upon request by an SCU. See Section 4.14.4.1.2.1.



5385 **4.14.4.1.2.1 Enterprise Identity Option**

An Image Display and Image Manager supporting the Enterprise Identity Option shall implement the requirements in this section.

5390 An Image Display (SCU) shall be able to request additional query matching and query return keys. Table 4.14-3 contains requirements for the Enterprise Identity Option that differ from those in Table 4.14-1.

An Image Manager (SCP) shall support additional query matching and query return keys upon request from the SCU. Table 4.14-3 contains requirements for the Enterprise Identity Option that differ from those in Table 4.14-1.

See Section 2.2 for more information on the notation in this table.

5395 **Table 4.14-3: Query Return Keys for Enterprise Identity Option**

Attribute Name	Tag	Query Keys Matching		Query Keys Return	
		SCU	SCP	SCU	SCP
Issuer of Accession Number Sequence	(0008,0051)	R+*	R+	R+*	R+
>Local Namespace Entity ID	(0040,0031)	R+*	R+	R+*	R+
>Universal Entity ID	(0040,0032)	R+*	R+	R+*	R+
>Universal Entity ID Type	(0040,0033)	R+*	R+	R+*	R+
Issuer of Patient ID	(0010,0021)	R+*	R+	R+*	R+
Issuer of Patient ID Qualifiers Sequence	(0010,0024)	O	O	R+*	R+
>Universal Entity ID	(0040,0032)	O	O	R+*	R+
>Universal Entity ID Type	(0040,0033)	O	O	R+*	R+
Other Patient IDs Sequence	(0010,1002)	O	O	R+*	R+
>Patient ID	(0010,0020)	O	O	R+*	R+
>Issuer of Patient ID	(0010,0021)	O	O	R+*	R+
>Issuer of Patient ID Qualifiers Sequence	(0010,0024)	O	O	R+*	R+
>>Universal Entity ID	(0040,0032)	O	O	R+*	R+
>>Universal Entity ID Type	(0040,0033)	O	O	R+*	R+
>Type of Patient ID	(0010,0022)	O	O	R+*	R+
Institution Name	(0008,0080)	O	O	R+*	R+
Institution Address	(0008,0081)	O	O	R+*	R+
Institution Code Sequence	(0008,0082)	O	O	R+*	R+
>Code Value	(0008,0100)	O	O	R+*	R+
>Coding Scheme Designator	(0008,0102)	O	O	R+*	R+
>Code Meaning	(0008,0104)	O	O	R+*	R+

#### **4.14.4.1.3 Expected Actions**

5400 The Image Archive receives the C-FIND request, performs the matching on the provided keys and sends the list of matching records back to the Image Display via C-FIND responses. It is the responsibility of the Image Manager to ensure that the patient and procedure information is current in the images when they are retrieved from the Image Archive. The patient and procedure information are updated through transactions [RAD-12] and [RAD-13].

5405 This means the Image Display may receive patient data inconsistent with those received from a previously issued query or retrieve operation. For example, in the event that a patient has been renamed, the Image Display will receive images with the same Study Instance UID, Series Instance UID and SOP Instance UIDs, but with a different patient name. The Image Display shall use the just queried information or the most recently received instances to ensure that the most recent patient data from the Image Manager/Archive is displayed.

## 4.15 Query Presentation States [RAD-15]

### 5410 4.15.1 Scope

This section describes the sequence of messages required for the Image Display to query the Image Archive for instances of Grayscale Softcopy Presentation States. The Image Display will query and then retrieve Presentation State objects together with the image data referenced in the return keys supplied in the response from the Image Archive or referenced in the Presentation State object. The transformations will be applied by the Image Display to the image data to assure the image display is consistent with the device that originally created and stored the Presentation State. The Image Display will be required to support all transformations defined in DICOM PS3.4: Grayscale Softcopy Presentation State Storage. In addition, multiple Presentation States may exist that reference the same image data.

### 5420 4.15.2 Actor Roles

**Actor:** Image Display

**Role:** Query for Grayscale Softcopy Presentation State objects together with the referenced image data and apply the transformations specified by the Presentation State. This actor must support pixel rendering according to the Grayscale Standard Display Function (GSDF) defined in DICOM [PS3.14 Section 7](#). This device will implement the Query/Retrieve SOP Classes in the role of SCU.

**Actor:** Image Archive

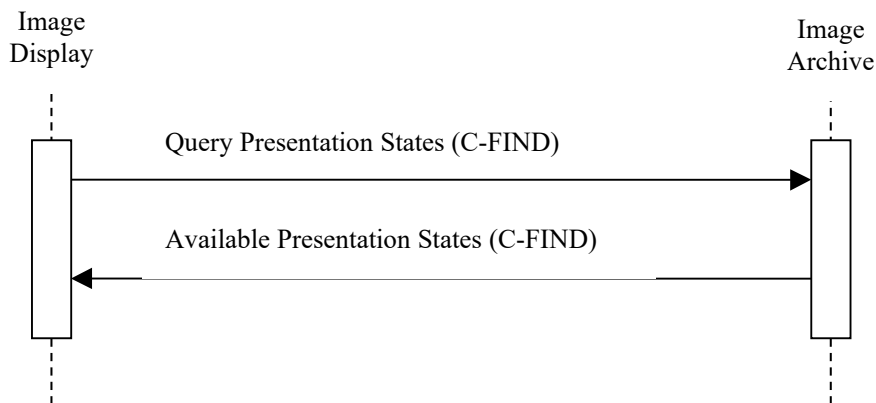
**Role:** Respond to queries from the Image Display for Grayscale Softcopy Presentation States objects. This device will implement the Query/Retrieve SOP Classes in the role of SCP.

### 5430 4.15.3 Referenced Standards

DICOM [PS3.4 Annex C](#): Query/Retrieve Service Class

DICOM [PS3.14](#): Grayscale Standard Display Function

#### 4.15.4 Messages



5435

**Figure 4.15.4-1: Interaction Diagram**

##### 4.15.4.1 Query for Grayscale Softcopy Presentation States

The Query (Study Root – FIND and optionally Patient Root – FIND) SOP Classes will be supported. Refer to DICOM [PS3.4 Annex C](#): Query/Retrieve Service Class for detailed descriptive semantics.

5440

##### 4.15.4.1.1 Trigger Events

The user of the Image Display wishes to query instances of Grayscale Softcopy Presentation States.

##### 4.15.4.1.2 Message Semantics

5445

The message semantics are defined by the DICOM Query/Retrieve SOP Classes: A C-FIND Request from the DICOM Study Root Query/Retrieve Information Model – FIND SOP Class or the optional DICOM Patient Root Query/Retrieve Information Model – FIND SOP Class. The C-FIND request shall be sent from the Image Display to the Image Archive.

The matching keys and return keys to be supported by the Image Display (SCU) and the Image Archive (SCP) at the Study and Series level are defined in Table 4.14-1.

5450

Table 4.15-1 below specifies for both the Query SCU (Image Display) and the Query SCP (Image Archive), additional Matching Keys (keys used as matching criteria in the Query request) and Return Keys (keys used to request attributes to be returned in the query responses) that are Required (“R”) or Optional (“O”), specific (or pertaining) to Presentation State. See Section 2.2 for more information.

5455

**Table 4.15-1: Presentation State Specific Query Matching and Return Keys**

Attribute Name	Tag	Query Keys Matching		Query Keys Return	
		SCU	SCP	SCU	SCP
Content Label	(0070,0080)	O	O	R+	R+
Content Description	(0070,0081)	O	O	O	R+
Presentation Creation Date	(0070,0082)	O	O	R+	R+
Presentation Creation Time	(0070,0083)	O	O	R+	R+
Content Creator's Name	(0070,0084)	O	O	R+	R+
Referenced Series Sequence	(0008,1115)				
>Series Instance UID	(0020,000E)	O	O	O	R+
>Referenced Image Sequence	(0008,1140)				
>>Referenced SOP Class UID	(0008,1150)	O	O	O	R+
>>Referenced SOP Instance UID	(0008,1155)	O	O	O	R+

**4.15.4.1.3 Expected Actions**

5460

The Image Archive receives the C-FIND request, matches on the provided keys and sends the list of matching records back to the Image Display via C-FIND responses. It is the responsibility of the Image Manager to ensure that the patient and procedure information is current in the images and Softcopy Presentation State objects when they are retrieved from the Image Archive. The patient and procedure information is updated through transactions [RAD-12] and [RAD-13].

5465

This means the Image Display may receive patient data inconsistent with those received from a previously issued query or retrieve operation. For example, in the event that a patient has been renamed, the Image Display will receive Softcopy Presentation State objects with the same Study Instance UID, Series Instance UID and SOP Instance UIDs, but with a different patient name. The Image Display shall use the just queried information or the most recently received instances to ensure that the most recent patient data from the Image Manger/Archive is displayed.

## 4.16 Retrieve Images [RAD-16]

### 5470 4.16.1 Scope

After the Image Display or Imaging Document Consumer request for image retrieval, the requested DICOM Images are transferred from the Image Archive to the Image Display or from the Imaging Document Source to the Imaging Document Consumer for viewing.

### 4.16.2 Actor Roles

5475 **Actor:** Image Archive

**Role:** Sends requested images to the Image Display.

**Actor:** Imaging Document Source:

**Role:** Sends requested images to the Imaging Document Consumer.

**Actor:** Image Display

5480 **Role:** Receives requested images from the Image Archive.

**Actor:** Imaging Document Consumer

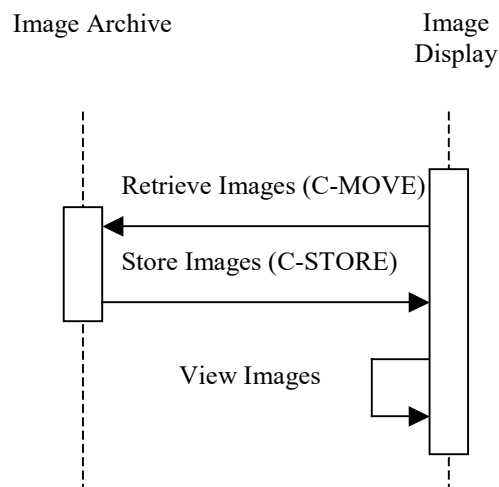
**Role:** Receives requested images from the Imaging Document Source.

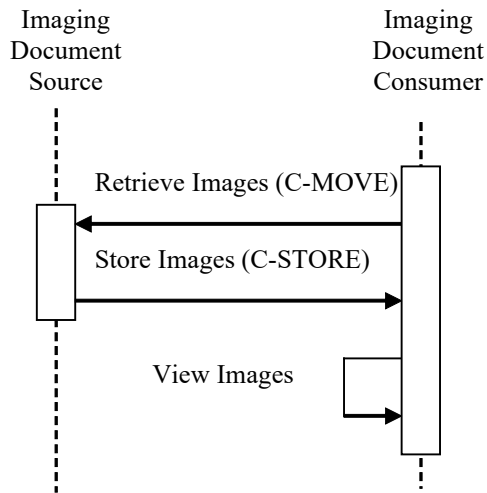
### 4.16.3 Referenced Standards

DICOM [PS3.4 Annex B](#): Storage Service Class

5485 DICOM [PS3.4 Annex C](#): Query/Retrieve Service Class

### 4.16.4 Messages





5490

**Image  
Display**

**Access Images  
(See Note 1)**

**View Images**

Note 1: Access to images may be through some means other than a network activity when the Image Display is grouped with another actor (e.g., Portable Media Importer), or has access through some other means (e.g., if the Image Display is encoded on media by the Portable Media Creator supporting the Basic Viewer Option in the Portable Data for Imaging Profile).

5495

**Figure 4.16.4-1: Interaction Diagram**

#### 4.16.4.1 Retrieve Images

The Retrieve (Study Root – MOVE and optionally Patient Root – MOVE) SOP Classes shall be supported. The DICOM Image Storage SOP Classes will be supported by the Image Archive or Imaging Document Source as an SCU. Refer to DICOM [PS3.4 Annex C](#), for detailed descriptive semantics.

5500

In the case of retrieving images in a Cross-Enterprise, imaging document sharing (XDS-I) network environment, a configuration of mapping the AE Titles to DICOM AE Network Addresses (IP Address and Port number) are needed to be exchanged between the Imaging

5505 Document Source and the Imaging Document Consumer. RAD TF-2x: Appendix G describes in detail the AE Title mapping to the DICOM AE Network Addresses.

**4.16.4.1.1 Trigger Events**

Images are selected for viewing at the Image Display or Imaging Document Consumer.

**4.16.4.1.2 Message Semantics**

5510 The message semantics are defined by the DICOM Query/Retrieve SOP Classes and the DICOM Image Storage SOP Classes.

A C-MOVE Request from the DICOM Study Root Query/Retrieve Information Model – MOVE SOP Class or the DICOM Patient Root Query/Retrieve Information Model – MOVE SOP Class shall be sent from the Image Display to the Image Archive or from the Imaging Document Consumer to the Imaging Document Source.

5515

**4.16.4.1.3 Expected Actions**

The Image Archive or Imaging Document Source receives the C-MOVE request, establishes a DICOM association with the Image Display or Imaging Document Consumer, respectively, and uses the appropriate DICOM Image Storage SOP Classes to transfer the requested images. The Image Display or Imaging Document Consumer is expected to support at least one of the SOP Classes specified in Table 4.8-1. It is assumed that support of retrieval for a SOP Class also means support for display.

5520

**4.16.4.1.3.1 NM Image Profile**

Image Manager/Image Archive, Imaging Document Source, Image Displays and Imaging Document Consumer Actors that claim the NM Image Profile shall support all the SOP Classes specified in Table 4.8-3 in Section 4.8.

5525

**4.16.4.1.3.2 Mammography Image Profile**

Image Manager/Image Archive Actors supporting the Mammography Image Profile shall support all the SOP Classes specified in Table 4.16.4.1.3.2-1.

5530

An Image Display supporting the Mammography Image Profile shall support all the SOP Classes specified in Table 4.16.4.1.3.2-1.

**Table 4.16.4.1.3.2-1: Mammography SOP Classes for Display**

SOP Class UID	SOP Class Name
1.2.840.10008.5.1.4.1.1.1.2	Digital Mammography Image Storage – For Presentation

Note that Image Displays are not required to support “For Processing” images.



### 4.16.4.1.3.3 Basic Image Review Profile

#### 5535 4.16.4.1.3.3.1 Basic Image Review Profile SOP Class Support

The following sub-sections define two levels of support for Image Display actors:

- *full support*, which includes all of the requirements described in Section 4.16.4.2.2.6.
- *partial (display-only) support*, which requires any single or multi-frame image, regardless of SOP Class
  - 5540 ○ to be rendered in a viewport, scrolled, windowed, panned and zoomed
  - but excludes spatial location, acquisition timing and technique annotation, localization, measurement and cross-referencing

#### 4.16.4.1.3.3.1.1 SOP Class Support for PDI Media

5545 A PDI Portable Media Creator that supports the Basic Viewer Option shall include an Image Display on the PDI media that provides full support for all of the DICOM SOP Classes of all Images included on the PDI media. It is not required to provide any support for other DICOM SOP Classes.

#### 4.16.4.1.3.3.1.2 SOP Class Support other than for PDI Media

5550 An Image Display supporting the Basic Image Review Profile that has not been included on PDI media (i.e., without the Basic Viewer Option) shall provide full support for all the SOP Classes specified in Table 4.16.4.1.3.3.1.2-1.

**Table 4.16.4.1.3.3.1.2-1: SOP Classes for Basic Image Review Profile**

SOP Class UID	SOP Class Name
1.2.840.10008.5.1.4.1.1.1	Computed Radiography Image Storage
1.2.840.10008.5.1.4.1.1.2	CT Image Storage
1.2.840.10008.5.1.4.1.1.1.1	Digital X-Ray Image Storage – For Presentation
1.2.840.10008.5.1.4.1.1.4	MR Image Storage
1.2.840.10008.5.1.4.1.1.7.2	Multi-frame Grayscale Byte Secondary Capture Image Storage
1.2.840.10008.5.1.4.1.1.7.3	Multi-frame Grayscale Word Secondary Capture Image Storage
1.2.840.10008.5.1.4.1.1.7.1	Multi-frame Single Bit Secondary Capture Image Storage
1.2.840.10008.5.1.4.1.1.7.4	Multi-frame True Color Secondary Capture Image Storage
1.2.840.10008.5.1.4.1.1.20	Nuclear Medicine Image Storage
1.2.840.10008.5.1.4.1.1.128	Positron Emission Tomography Image Storage
1.2.840.10008.5.1.4.1.1.7	Secondary Capture Image Storage
1.2.840.10008.5.1.4.1.1.6.1	Ultrasound Image Storage
1.2.840.10008.5.1.4.1.1.3.1	Ultrasound Multi-frame Image Storage
1.2.840.10008.5.1.4.1.1.12.1	X-Ray Angiographic Image Storage
1.2.840.10008.5.1.4.1.1.12.2	X-Ray Radiofluoroscopic Image Storage

5555 There is no explicit requirement to provide full support for other DICOM SOP Classes, since at this time these are either thought to be beyond the capability of basic image review (e.g., the Enhanced family of objects), or are specifically addressed by other profiles (e.g., mammography), or are outside the domain of radiology (e.g., visible light in general, ophthalmology, slide microscopy, dentistry).

5560 An Image Display supporting the Basic Image Review Profile that has not been included on PDI media (i.e., without the Basic Viewer Option) shall provide partial (display-only) support for all SOP Classes not specified in Table 4.16.4.1.3.3.1.2-1 that have the following characteristics:

- Pixel Data (7FE0,0010) data element present
- Bits Allocated (0028,0100) of 8 or 16
- Bits Stored (0028,0101) values of 1 or 8 for Bits Allocated (0028,0100) of 8
- Bits Stored (0028,0101) values of 9 to 16 inclusive, for Bits Allocated (0028,0100) of 16
- 5565 • High Bit (0028,0102) of one less than Bits Stored (0028,0101) (i.e., in the low bits of the word, without packing)
- Samples Per Pixel (0028,0002) of 1 or 3
- Photometric Interpretation (0028,0004) of MONOCHROME1, MONOCHROME2, RGB, PALETTE COLOR, and any appropriate value for any multi-component compressed transfer syntaxes that are supported (e.g., YBR\_FULL\_422 for JPEG)
- 5570 • Planar Configuration (0028,0006) of 0 or 1 for RGB Photometric Interpretation (0028,0004) (i.e., color-by-pixel or color-by-plane)
- Pixel Representation (0028,0103) of 0 or 1 for MONOCHROME1 and MONOCHROME2 Photometric Interpretation (0028,0004) (i.e., signed or unsigned)
- 5575 • Number of Frames (0028,0008) absent or with any value (i.e., single or multi-frame images)

#### **4.16.4.1.3.4 MR Diffusion Imaging Profile**

This section is currently in the [MR Diffusion Imaging](#) (DIFF) Trial Implementation Supplement.

#### **4.16.4.1.3.5 CT/MR Perfusion Imaging with Contrast Profile**

5580 This section is currently in the [CT/MR Perfusion Imaging](#) (PERF) Trial Implementation Supplement.

#### **4.16.4.1.3.6 Intentionally Left Blank**

#### **4.16.4.1.3.7 Digital Breast Tomosynthesis Profile**

5585 Image Display and Image Manager/Image Archive Actors in the Digital Breast Tomosynthesis Profile shall support retrieval of the SOP Classes with the optionality specified in Table 4.16.4.1.3.7-1.

**Table 4.16.4.1.3.7-1: DBT SOP Classes for Retrieval**

SOP Class UID	SOP Class Name	Optionality (Image Display)	Optionality (Image Manager/Image Archive)
1.2.840.10008.5.1.4.1.1.13.1.3	Breast Tomosynthesis Image Storage	R	R
1.2.840.10008.5.1.4.1.1.1.2	Digital Mammography X-Ray Image Storage – For Presentation	R	R
1.2.840.10008.5.1.4.1.1.1.2.1	Digital Mammography X-Ray Image Storage – For Processing	O	R
1.2.840.10008.5.1.4.1.1.13.1.4	Breast Projection X-Ray Image Storage – For Presentation (Note 1)	O	O
1.2.840.10008.5.1.4.1.1.13.1.5	Breast Projection X-Ray Image Storage – For Processing (Note 2)	-	O

Note 1: Support for Breast Projection X-Ray Image Storage – For Presentation SOP Class is required if the For Presentation Breast Projection X-Ray Image Option is supported.

5590

Note 2: Support for Breast Projection X-Ray Image Storage –For Processing SOP Classes is required if the For Processing Breast Projection X-Ray Image Option is supported.

Image Displays may support the transfer syntaxes listed in Table 4.8.4.1.2.7-4.

Image Displays are only expected to support a single traversal of a volume stored in a Breast Tomosynthesis Image Storage instance (i.e., Image Position (Patient) (0020, 0032) has a different value for each frame).

5595

Image Manager/ Image Archives participating in the Digital Breast Tomosynthesis Profile shall support the compression transfer syntaxes as listed in Table 4.8.4.1.2.7-4 for retrieval.

#### 4.16.4.2 View Images

This transaction relates to the “View Images” event of the above interaction diagram.

5600

##### 4.16.4.2.1 Trigger Events

The Image Display or Imaging Document Consumer is requested to be capable to display the images.

##### 4.16.4.2.2 Invocation Semantics

This is a local invocation of functions at the Image Display or Imaging Document Consumer.

5605

##### 4.16.4.2.2.1 Display of Digital X-Ray, Mammo and Intra-Oral Images

For the Breast Tomosynthesis Image, “For Presentation” variant of the Digital X-Ray Image, the Digital Mammography X-Ray Image, the Breast Projection X-Ray Image, and the Digital Intra-oral X-Ray Image, the Image Display or Imaging Document Consumer shall have both the capability to apply all the transformations specified by the VOI LUT Sequence (0028,3010) and

- 5610 the capability to apply all the transformations specified by the Window Width (0028,1051)/Window Center (0028,1050)/VOI LUT Function (0028,1056) attributes as selected by the user from the choices available (e.g., guided by Window Center/Width Explanation (0028,1055) or LUT Explanation (0028,3003). These attributes may be nested in a Functional Groups Sequence depending on the SOP Class,
- 5615 If VOI LUT Function (0028,1056) is absent, then Window Width (0028,1051)/Window Center (0028,1050) shall be assumed to be the parameters of a linear window operation. VOI LUT Function (0028,1056) values of “SIGMOID” and “LINEAR” shall be supported.
- The Image Display or Imaging Document Consumer shall support the application of LUT Data (0028,3006) in items of the VOI LUT Sequence (0028,3010) regardless of the Value Representation (i.e., the DICOM standard allows either OW or US Value Representation).
- 5620 The Image Display or Imaging Document Consumer must also support pixel rendering according to the Grayscale Standard Display Function (GSDF) defined in DICOM [PS3.14](#), because the output values of these images are always P-Values.
- If the DICOM image is referenced by other DICOM composite objects, such as Grayscale Softcopy Presentation States, it is optional for the Image Display or Imaging Document Consumer to actually retrieve and display/apply these objects.
- 5625

#### **4.16.4.2.2.1.1 Display of Digital Mammography Images**

The contents of this section are required for Image Display claiming the Mammography Image Profile.

- 5630 The following requirements are intended to establish a baseline level of capabilities. Providing more intelligent and advanced capabilities is both allowed and encouraged and the profile is not intended to be limiting in any way with respect to capabilities. The intention is not to dictate implementation details.
- All mammography Image Displays shall support the Retrieve Images transaction for “For Presentation” images.
- 5635
- The Image Display shall be capable of displaying simultaneously a set of current and prior conventional four view screening mammogram images (left and right CC and MLO views), regardless of whether these images are in one or multiple DICOM Series.
- An Image Display that supports the Mammography Image Profile shall support calibration as described in the DICOM Grayscale Standard Display Function (GSDF). The minimum and maximum luminance of the display shall be configurable by the site, within the gamut of the device, for the purpose of conforming to local, regional or national regulatory and other requirements for luminance settings throughout the organization. For example, a site may require that all Image Displays used for primary interpretation be calibrated to the same minimum and maximum luminance.
- 5640
- 5645

#### **4.16.4.2.2.1.1.1 Background Air Suppression**

5650 Image Displays shall be capable of recognizing pixels that have the value specified in Pixel Padding Value (0028,0120) when present alone, and between Pixel Padding Value (0028,0120) and Pixel Padding Range Limit (0028,0121) inclusive when both elements are present, and setting them to a minimum display value that is not affected by image contrast adjustments, including inversion of the image contrast.

#### **4.16.4.2.2.1.1.2 Image Orientation and Justification**

Image Displays shall not assume that the pixel data is encoded with an orientation that is suitable for direct display to the user without flipping or rotating into the correct orientation.

5655 The Image Display shall use the values of Image Laterality (0020,0062), View Code Sequence (0054,0220), View Modifier Code Sequence (0054,0222) and Patient Orientation (0020,0020) to display images according to the preferred hanging protocol of the current user, rather than depend on descriptive attributes such as Series Description (0008,103E).

5660 The Image Display shall allow the user to select or configure hanging protocols such that given a set of images containing these attributes, the placement of images relative to one another, the required orientation of the images, the display of current and prior images, and the sequence of layouts displayed can be defined.

5665 Note that images are normally displayed such that the axilla is towards the top of the viewport, except for cleavage views (which contain two axillas). The location of the axilla can be determined from the direction of the head encoded in Patient Orientation (0020,0020) in the case of lateral and oblique views, and the Image Laterality (0020,0062) in the case of cranio-caudal or caudo-cranial views. For cleavage views, indicated by the presence of a View Modifier Code Sequence (0054,0222) Item containing (399161006, SCT, “Cleavage”), either axilla may be at the top of the view port. (Earlier versions of the Radiology Technical Framework contained the SNM3 equivalent of the SCT code for “Cleavage”; the SNM3 code is now retired. See DICOM [PS3.16 Section 8.3](#) “Retired Codes and Expected Behavior”.)

5670

The Image Display shall be able to distinguish and display separately images with one or more Items in a View Modifier Code Sequence (0054,0222) from each other and those without a View Modifier Code Sequence (0054,0222) Item.

5675 The Image Display shall be capable of horizontally justifying the image to the left or right side of the viewport rather than centering it, when the aspect ratio (ratio of the number of rows and columns) of the viewport does not match aspect ratio of the image, in order to avoid displaying any unnecessary padding between the adjacent chest walls of back to back images; excessive window decoration (such as scroll bars) shall not be displayed between back to back viewports.

#### **4.16.4.2.2.1.1.3 Image Size**

5680 The physical size of the pixels in an image for the purposes of the display modes defined in this section shall be approximated by using the values of Imager Pixel Spacing (0018,1164).

5685 The physical size of the pixels in an image for the purposes of distance measurements and the display of a distance caliper shall be approximated by using the values of Imager Pixel Spacing (0018,1164) divided by Estimated Radiographic Magnification Factor (0018,1114).

5690 For contact (unmagnified) views, the value of Estimated Radiographic Magnification Factor (0018,1114) is typically 1, or close to 1, depending on the distance between the detector side of the compressed breast and the front of the detector housing (the latter being the plane in which Imager Pixel Spacing (0018,1164) is defined), and what depth the nominal location of the object plane is within the compressed breast.

For magnification views, the spacing between the detector side of the compressed breast and the detector is increased substantially relative to the distance to the x-ray source to obtain geometric magnification, and Estimated Radiographic Magnification Factor (0018,1114) will have a value substantially greater than 1.

5695 Pixel Spacing (0028,0030) shall not be used to determine size for the purpose of sizing for display or distance measurements. DICOM CP 586, which clarifies the meaning of Pixel Spacing (0028,0030) values that differ from Imager Pixel Spacing (0018,1164) values when an image has been calibrated by use of a fiducial of known size within the image, is not relevant to mammography applications.

5700 Note that the use of Imager Pixel Spacing (0018,1164) is sufficient regardless of the physical size of the detector used.

#### **4.16.4.2.2.1.1.3.1 Same Size**

5705 The Image Display shall be capable of displaying multiple images such that all images are at the same relative physical size, regardless of whether they have the same values of Imager Pixel Spacing (0018,1164) or not.

5710 For example, a user reviewing a four-view screening mammogram together with a four-view prior mammogram might want to display eight viewports, each showing one view, such that each view is at the same relative physical size, even if the images were obtained on detectors with different sized pixels. This allows the user to compare features in the prior and current images to visually assess whether or not they have changed in size.

Note that it is not expected that the Image Display attempt to compensate for the location of the object within the compressed breast of finite thickness along the x-ray beam, since the convention for measurement from film-screen practice assumes that all objects are located at the cassette (detector) side of the breast.

5715 This mode of display is not intended for comparison of geometrically magnified views at the same time as non-magnified views, since the geometrically magnified view would then be displayed too small.

#### **4.16.4.2.2.1.1.3.2 True Size**

5720 The Image Display shall be capable of displaying multiple images such that all images are true size, regardless of whether they have the same values of Imager Pixel Spacing (0018,1164) or not.

True size is defined as the display of an image such that an object in the image when measured with a hand-held ruler on the surface of the display measures as closely as possible to the true physical size of the object if located on the front face of the detector housing.

5725 This mode of display is not intended for geometrically magnified views, since the geometrically magnified view would then be displayed too small.

#### **4.16.4.2.2.1.1.3.3 View Actual Pixels**

The Image Display shall be capable of displaying multiple images such that each encoded pixel occupies one display pixel in the viewport.

5730 If the size of the pixel data exceeds the size of the viewport, it may not be possible to display all of the encoded pixels at once, in which case some form of pan or quadrant navigation functionality shall be provided.

Since there is no minification or magnification, images with different pixel physical size will be displayed in this mode such that the physical size in the patient will appear different.

#### **5735 4.16.4.2.2.1.1.4 Image Contrast Adjustment**

As described in Section 4.16.4.2.2.1 Display of Digital X-Ray, Mammography and Intra-Oral Images, the Image Display shall provide the user with the ability to select amongst the available window and VOI LUT choices available in the image object.

5740 Subsequent to the initial application of the chosen contrast transformation, the Image Display shall allow the user to adjust the contrast without reverting to a purely linear transformation:

- If the chosen contrast transformation is a lookup table, then the Image Display shall allow the input value of the lookup table to be stretched and translated so as to give the effect of adjusting contrast and brightness whilst applying the same general shape as the curve encoded in the lookup table. To provide feedback to the user, the “window width” can be reported as the adjusted range of input values to the LUT, and the “window center” can be reported as the center value of that range.
- If the chosen contrast transformation is a sigmoid shaped VOI LUT Function parameterized by the window center and width, then the Image Display shall allow the window center and width values to be adjusted and a sigmoid function reapplied.

5750 If a Pixel Padding Value (0028,0120) only is present in the image then image contrast manipulations shall not be applied to those pixels with the value specified in Pixel Padding Value (0028,0120).

If both Pixel Padding Value (0028,0120) and Pixel Padding Range Limit (0028,0121) are present in the image then image contrast manipulations shall not be applied to those pixels with values in

5755 the range between the values of Pixel Padding Value (0028,0120) and Pixel Padding Range Limit (0028,0121), inclusive.

**4.16.4.2.2.1.1.5 Annotation of Image Information**

5760 Quite apart from good practice, there are nationally-specific requirements for information to be displayed (or displayable) to the user in order to ensure correct identification of the patient and study during reporting and review as well as the resolution of quality issues.

This profile defines the union of currently known and anticipated nationally-specific requirements with respect to annotation.

It is desirable that the subset of attributes displayed be configurable by the user or the site.

5765 If annotations are overlaid on the displayed image, the Image Display shall not annotate the edge that contains the chest wall, as determined from (0020,0020) Patient Orientation, so as to avoid covering breast tissue.

**4.16.4.2.2.1.1.5.1 Annotation of Identification Information**

The Image Display shall be capable of displaying the information contained in the attributes listed in Table 4.16.4.2.2.1.1.5.1-1. The required information is defined in two categories:

- 5770
- Clinical - Those attributes that are useful during interpretation and review of the images for clinical purposes, and which under normal circumstances should be displayed
  - Investigative - Those attributes that are useful for investigative purposes, such as to trace a quality problem, and which under normal circumstances are a distraction and should not be displayed until requested by the user

5775 **Table 4.16.4.2.2.1.1.5.1-1: Identification Attributes for Display**

Attribute	Tag	Requirement
Patient’s Name	(0010,0010)	Clinical
Patient ID	(0010,0020)	Clinical
Patient’s Birth Date	(0010,0030)	Clinical
Patient’s Age	(0010,1010)	Clinical
Acquisition Date	(0008,0022)	Clinical
Acquisition Time	(0008,0032)	Clinical
Operator’s Name	(0008,1070)	Clinical
Manufacturer	(0008,0070)	Investigative
Institution Name	(0008,0080)	Clinical
Institution Address	(0008,0081)	Investigative
Manufacturer’s Model Name	(0008,1090)	Investigative
Device Serial Number	(0018,1000)	Investigative
Detector ID	(0018,700A)	Investigative
Software Versions	(0018,1020)	Investigative



Attribute	Tag	Requirement
Station Name	(0008,1010)	Clinical
Gantry ID	(0018,1008)	Clinical (for CR overrides Station Name, which is plate reader)
Date of Last Detector Calibration	(0018,700C)	Investigative

Note that it is common practice to use the Operator's Name (0008,1070) to encode the initials rather than the full name of the operator, and this is sufficient to meet known regulatory requirements.

5780 Note also that Station Name (0008,1010) (or Gantry ID (0018,1008) for CR) are typically short, human-recognizable strings meaningful to the users, and are preferred for satisfying any regulatory requirement for "mammography unit identification" over the more cryptic but precise attributes like Device Serial Number (0018,1000).

5785 The Image Display shall make the investigative set of values available to the ordinary user, but these need not necessarily be annotated directly on the image, e.g., they might be displayed in a separate pop-up window.

It shall be possible to turn on or off either set of annotations at the user's discretion.

#### 4.16.4.2.2.1.1.5.2 Annotation of Technical Factor Information

Good practice dictates that certain technical factors be displayed (or displayable) to the user in order to detect and resolve quality issues.

5790 In addition, there are technical factors that are unique to the digital realm. One such factor is related to the adjustment of the sensitivity and/or dynamic range of the sensor or processing, corresponding to the amount of radiation reaching the detector. These are variously referred to by manufacturers as ADU, exposure index, or sensitivity. Note that interpretation of this value is vendor-specific, though may be standardized in the future by AAPM.

5795 The Image Display shall be capable of displaying the information contained in the attributes listed in Table 4.16.4.2.2.1.1.5.2-1.

**Table 4.16.4.2.2.1.1.5.2-1: Technique Attributes for Display**

Attribute	Tag
KVP	(0018,0060)
Exposure	(0018,1152)
Exposure Time	(0018,1150)
Filter Material	(0018,7050)
Anode Target Material	(0018,1191)
Compression Force	(0018,11A2)
Body Part Thickness	(0018,11A0)
Positioner Primary Angle	(0018,1510)
Relative X-ray Exposure	(0018,1405)
Entrance Dose in mGy	(0040,8302)

Attribute	Tag
Organ Dose	(0040,0316)

It shall be possible to turn on or off the annotations at the user’s discretion.

**4.16.4.2.2.1.1.5.3 Annotation of View Information**

5800 Traditional film-screen practice requires the use of lead markers consisting of letters encoding the type of view, located in the corner of the film that is opposite the chest wall and towards the axilla.

Image Displays shall mimic this practice by annotating the viewport with abbreviations derived from the value of Image Laterality (0020,0062), View Code Sequence (0054,0220) and any values of View Modifier Code Sequence (0054,0222) Items that are present.

5805 Unless otherwise overridden by nationally specific extensions, the specific abbreviations to be displayed are as defined in the View Modifier Abbreviations Column of DICOM PS3.16 [CID 4014](#) and [CID 4015](#), which is derived from ACR MQCM 1999, with the following clarifications:

- 5810 • The Image Laterality shall be prepended to the abbreviation, e.g., a right CC view shall be displayed as “RCC”
- A CC view with a cleavage modifier shall be annotated as only “CV” if Image Laterality has a value of “B”, i.e., the “CC” shall not be displayed, and the laterality shall be omitted (in which case the left and right breast can be determined from the value of Patient Orientation (0020,0020)); otherwise “LCV” or “RCV” shall be used
- 5815 • A right MLO view with the axillary tail modifier shall be annotated only as “RAT”, i.e., the “MLO” shall not be displayed
- The implant displaced modifier shall be appended as a suffix to the view, as if it were defined as “...ID”, e.g., a right implant displaced CC view would be annotated as “RCCID”
- 5820 • A spot compression modifier shall be prepended as a prefix to the view, as if it were defined as “S...”, e.g., a left spot compression CC view would be annotated as “LSCC”
- A tangential modifier shall be annotated as only “TAN”, i.e., the “CC” or whatever else is encoded as the view, shall not be displayed
- 5825 • When multiple prefix or suffix modifiers are present, they shall be sorted alphabetically, e.g., a right magnified, spot compression, implant displaced, rolled lateral CC view would be annotated as “RMSCCIDRL”

Spaces and other delimiters are permitted between components of the abbreviations.

5830 Prior to any flip or rotation for display, the location of the corner opposite the chest wall and towards the axilla can be determined from the direction of the chest wall encoding in Patient Orientation (0020,0020), regardless of view, and the direction of the head encoded in Patient Orientation (0020,0020) in the case of lateral and oblique views, and the Image Laterality (0020,0062) in the case of cranio-caudal or caudo-cranial views. For cleavage views, the axilla at

the top of the viewport shall be annotated. See also Section 4.16.4.2.2.1.1.2 Image Orientation and Justification.

5835 It shall be possible to turn on or off the annotations at the user's discretion.

#### **4.16.4.2.2.1.1.6 Annotation of Size Information**

For the purpose of this section, physical pixel size is as defined in Section 4.16.4.2.2.1.1.3 Image Size.

5840 The user needs to be aware when the displayed image does not reflect a 1:1 rendition of an encoded image pixel to a displayed pixel, i.e., that some magnification or minification has taken place. Anything other than 1:1 rendition may result in loss or distortion of information.

Further, the user needs to be aware of whether or not the image is displayed at true size, and whether or not different images are at the same relative physical size.

5845 Therefore, the Image Display shall be capable of annotating the displayed images with the following:

- Pixel Size Magnification - Number of displayed pixels relative to the number of encoded image pixels, such that a factor of 1.0 (or 100%) means 1:1 rendition, a factor of less than 1.0 means that one pixel on the display represents more than one pixel in the encoded image (minification), and a factor of greater than 1.0 means that pixels in the encoded image have been replicated or interpolated to span multiple displayed pixels (magnification)
- True Size Magnification - Size of the displayed pixels relative to true size, such that a factor of 1.0 (or 100%) means true size, a factor of less than 1.0 means smaller than true size, and a factor of greater than 1.0 means larger than true size

5855 The exact form of these two relative pixel size indications is left to the discretion of the implementer.

The Image Display shall be capable of displaying a ruler or caliper indicating the physical size of the displayed image, for the purpose of providing a visual cue to the user of the general size of the features in the image. It shall be possible to turn on or off the ruler at the user's discretion.

5860 The Image Display shall provide a means of accurately measuring distance between two points based on the physical size of the image pixels.

#### **4.16.4.2.2.1.1.7 Partial View Option**

If the Image Display supports the Partial View Option, it shall additionally annotate the displayed image in the view port to indicate:

- when the image is a partial view, as defined by the presence of Attribute Partial View (0028,1350) with a value of YES
- which region of the mosaic the image represents, as encoded in Partial View Code Sequence (0028,1352), if present

5870 Whether or not this annotation is textual or in the form of some iconic graphic representation, and whether or not any navigational or layout assistance is provided for the entire mosaic is at the discretion of the implementer.

#### **4.16.4.2.2.1.1.8 Display of CAD Marks**

5875 Image Displays shall be able to apply marks on the displayed image corresponding to all findings encoded in Mammography CAD SR objects with a (111056, DCM, “Rendering Intent”) value of (111150, DCM, “Presentation Required”). They may be able to display additional findings that have a (111056, DCM, “Rendering Intent”) value of (111151, DCM, “Presentation Optional”).

5880 The Image Display shall make the user aware that CAD marks are available for display, and indicate whether or not CAD marks are currently activated. More than one set of CAD objects could be available that are applicable to the same image (e.g., CAD was run more than once on the same images). If this is the case then all CAD SRs shall be made available for display on the review workstation with the most recent CAD SR (by Content Date/Time) being displayed by default. The user shall be able to choose which CAD SR object is to be displayed.

Only a single CAD SR object at a time shall be applied to a displayed image.

5885 The Image Display shall be able to apply the marks to “For Presentation” images that are referenced by the Mammography CAD SR SOP Instance.

The Image Display shall also be able to apply the marks to “For Presentation” images whose Source Image Sequence references the SOP Instance UID of the “For Processing” images that are referenced by the Mammography CAD SR SOP Instance, unless the Spatial Locations Preserved (0028,135A) is present in the Source Image Sequence Item and has a value of NO.

5890 The Patient Orientation of the images referenced in the Source Image Sequence encoded in (111044, DCM, “Patient Orientation Row”) and (111043, DCM, “Patient Orientation Column”) of the Mammography CAD SR SOP Instance shall be used to transform (flip or rotate) the coordinates of the CAD marks if it differs from the Patient Orientation (0020,0020) of the corresponding “For Presentation” image.

5895 The form in which the CAD marks are displayed may influence observer performance, and hence it may be necessary to display them in a manner prescribed by the CAD device vendor, which is not encoded in the DICOM object. The form of the CAD mark rendering is out of the scope of this profile to define.

5900 The Image Display shall make available for display the following information about each CAD finding, if encoded in the CAD object:

- Manufacturer (0008,0070)
- Algorithm as defined in (111001, DCM, “Algorithm Name”) and (111003, DCM, “Algorithm Version”)
- Operating point as defined in (111071, DCM, “CAD Operating Point”)
- 5905 • Content Date (0008,0023) and Content Time (0008,0033) of the CAD SR instance, if more than one exists and applies to the displayed image

5910 The Image Display shall indicate when CAD was not attempted or has failed, either entirely, or if some algorithms have succeeded and others failed, as distinct from when CAD has succeeded but there are no findings. This information shall be obtained from the status values of (111064, DCM, “Summary of Detections”) and (111065, DCM, “Summary of Analyses”).

#### **4.16.4.2.2.1.1.9 Post-Processing of For Presentation Images**

This profile does not constrain the ability of the Image Display to further post-process “For Presentation” images, for example with edge enhancement or noise reduction.

5915 However, there shall be a mode in which actual pixels of “For Presentation” images are displayed not only with 1:1 display to encoded pixel size, but with no further processing or interpolation other than application of point grayscale transformations.

#### **4.16.4.2.2.1.1.10 Accidental reading of prior studies**

5920 There is a significant risk that during primary interpretation the most recently available prior study on the Image Display will be interpreted by the user as the current study, if for some reason the current study is not available.

Accordingly, it is required that an Image Display explicitly warn the user if none of the studies being displayed are within a user configurable period from the current real time, as determined by Acquisition Date (0008,0022).

#### **4.16.4.2.2.1.2 Intentionally Left Blank**

#### **5925 4.16.4.2.2.1.3 Display of DBT Images**

Image Displays participating in the Digital Breast Tomosynthesis Profile shall fulfill all requirements listed in Section 4.16.4.2.2.1.1 for the display of Digital Mammography X-Ray Image instances in addition to requirements listed in this section.

5930 In the Digital Breast Tomosynthesis Profile, since current and prior studies may be performed with either conventional 2D mammography or DBT or both, and since DBT images may consist of tomosynthesis reconstructions alone, or together with either the projection images (if the For Presentation Breast Projection X-Ray Images Option is supported), or generated 2D images or both, the Image Display shall be capable of displaying combinations of screening views (typically left and right CC and MLO) from a current and prior set of a pair of any of the following types of acquisition:

- 5935
- Tomosynthesis slices
  - Tomosynthesis slabs
  - Conventional 2D mammography images
  - Generated 2D images derived from tomosynthesis data

5940 I.e., Assuming an eight viewport layout, Image Displays shall be at minimum capable of displaying the following combinations based on the user preferences:

- Up to four views of current and prior study of the same acquisition type (e.g., current and prior DBT slices, or current and prior conventional 2D mammography images).
- 5945 • Up to four views of current study of one acquisition type compared with the same views of current exam of a different acquisition type (e.g., current conventional 2D mammography images and current DBT slices).
- Up to four views of current study of one acquisition type compared with the same views of a prior of a different acquisition type (e.g., current DBT slices with prior conventional 2D mammography images).

5950 Furthermore, the user shall be provided with a means to toggle between the available conventional 2D mammography images, tomosynthesis slices, tomosynthesis projection images (if the For Presentation Breast Projection X-Ray Images Option is supported), and generated 2D image for the views currently displayed without affecting the display layout.

5955 Image Displays shall support calibration as described in DICOM [PS3.14](#) Grayscale Standard Display Function (GSDF). The minimum and maximum luminance of the display shall be configurable by the site, within the gamut of the device, for the purpose of conforming to local, regional or national regulatory and other requirements for luminance settings throughout the organization. For example, a site may require that all Image Displays used for consultation be calibrated to the same minimum and maximum luminance.

#### 5960 **4.16.4.2.2.1.3.1 Background Air Suppression**

Image Displays shall apply background air suppression to tomosynthesis slices and generated 2D images as defined in Section 4.16.4.2.2.1.1.1.

#### **4.16.4.2.2.1.3.2 Image Orientation and Justification**

5965 Image Displays shall apply image orientation and justification requirements as described in Section 4.16.4.2.2.1.1.2 to tomosynthesis slices, and generated 2D images.

5970 For images encoded with the Breast Tomosynthesis Image IOD, the orientation information is stored within the Image Orientation (Patient) (0020,0037) attribute in the Plane Orientation Sequence (0020,9116) of the Shared Functional Groups Sequence (5200,9229), and consideration of this pair of unit vectors describing the orientation of the image rows and columns with respect to the patient-relative 3D coordinate system is required to determine the orientation of the image, since Patient Orientation (0020,0020) is not present in the Breast Tomosynthesis Image IOD. The Image Display shall not assume that Patient Orientation (0020,0020), if present, is reliable, and shall not assume that the pixels are encoded with any particular or expected orientation.

5975 For images encoded with the Breast Tomosynthesis Image IOD, the Image Display shall use the View Code Sequence (0054,0220), View Modifier Code Sequence (0054,0222) and Frame Laterality (0020,9072) in the Frame Anatomy Sequence (0020,9071) of the Shared Functional Groups Sequence (5200,9229) together with Image Orientation (Patient) (0020,0037) to display images according to the preferred hanging protocol of the current user.

5980 **4.16.4.2.2.1.3.3 Image Size**

The physical size of the pixels in an image encoded with the Breast Tomosynthesis Image IOD for the purposes of image sizing, distance measurements and the display of a distance caliper shall be approximated by using the values of Pixel Spacing (0028,0030) since geometric effects will have been accounted for during reconstruction.

5985 Pixel Spacing (0028,0030) within the Pixel Measures Sequence (0028,9110) may either be part of the Shared Functional Groups Sequence (5200,9229) or the Per-frame Functional Groups Sequence (5200,9230).

**4.16.4.2.2.1.3.3.1 Same Size**

5990 Image Displays shall be capable of displaying multiple single frame or multi-frame images such that all images are at the same relative physical size, regardless of whether they have the same values of Pixel Spacing (0028,0030) or not.

5995 Further, within a single Breast Tomosynthesis Image instance, the Image Display shall be capable of displaying multiple frames of the image such that all frames are at the same relative physical size, regardless of whether they have the same values of Pixel Spacing (0028,0030) or not.

This means that as the user scrolls through each frame, the encoded pixel data for each frame may need to be interpolated with a different magnification factor than adjacent frames.

6000 The location about which the frame pixel data is interpolated shall be chosen for successive slices such that the displayed image remains centered vertically at the middle of the vertical extent of the viewport and centered horizontally at the chest wall side of the viewport, until/if the user explicitly pans or zooms the displayed image to establish a new extent of pixels to be displayed.

6005 The initial state (magnification factor relative to the physical size of the patient) is at the discretion of the implementer, but since multiple images (different views and prior images) are required to be at the same size, whether or not a particular tomosynthesis slice is used to establish the initial size is not of importance, since the variation in spatial extent (how much of the breast tissue occupies a particular frame or image) is likely to vary more between sides, views and priors than within a set of frames for one image.

6010 For Same Size display of any supported combination of conventional 2D mammography images with tomosynthesis slices and/or generated 2D images, the physical size of the pixels in a conventional 2D mammography image shall be approximated by using the values of Imager Pixel Spacing (0018,1164) divided by Estimated Radiographic Magnification Factor (0018,1114), to account for geometric effects.

**4.16.4.2.2.1.3.3.2 True Size**

6015 Image Displays shall be capable of displaying multiple single frame or multi-frame images such that all images are true size, regardless of whether they have the same values of Pixel Spacing (0028,0030) or not.

6020 Further, within a single Breast Tomosynthesis Image instance, the Image Display shall be capable of displaying multiple frames of the image such that all frames are at true size, regardless of whether they have the same values of Pixel Spacing (0028,0030) or not.

6025 For True Size display of any supported combination of conventional 2D mammography images with tomosynthesis slices and/or generated 2D images, the physical size of the pixels in a conventional 2D mammography image shall be approximated by using the values of Imager Pixel Spacing (0018,1164) divided by Estimated Radiographic Magnification Factor (0018,1114), to account for geometric effects.

**4.16.4.2.2.1.3.3 View Actual Pixels**

For Image Displays, the view actual pixels display as described in Section 4.16.4.2.2.1.1.3.3 shall be applicable during display of any supported combination of conventional 2D mammography images, tomosynthesis slices and generated 2D images.

6030 **4.16.4.2.2.1.3.4 Image Contrast Adjustments**

For Image Displays, the image contrast adjustment requirements in Section 4.16.4.2.2.1.1.4 shall be applied during the display of any combination of conventional 2D mammography images, tomosynthesis slices and generated 2D images.

6035 VOI LUT Sequence (0028,3010), Window Center (0028,1050) and Window Width (0028,1051) within the Frame VOI LUT Sequence (0028,9132) may either be part of the Shared Functional Groups Sequence (5200,9229) or the Per-frame Functional Groups Sequence (5200,9230).

**4.16.4.2.2.1.3.5 Annotation of Image Information**

6040 For Image Displays the annotation requirements in Section 4.16.4.2.2.1.1.5 and all its sub-sections shall be applied during the display of any combination of conventional 2D mammography images, tomosynthesis slices, and generated 2D images except that, for images encoded with the Breast Tomosynthesis Image IOD the chest wall determination shall be based on Image Orientation (Patient) (0020,0037) in the Plane Orientation Sequence (0020,9116) of the Shared Functional Groups Sequence (5200,9229) rather than Patient Orientation (0020,0020) to avoid covering of breast tissue with annotations.

6045 **4.16.4.2.2.1.3.5.1 Annotation of Identification Information**

Image Displays shall fulfill the requirements defined in Section 4.16.4.2.2.1.1.5.1 for the attributes listed in Table 4.16.4.2.2.1.3.5.1-1.

**Table 4.16.4.2.2.1.3.5.1-1: Identification Attributes for Display**

Attribute	Tag	Requirement
Patient's Name	(0010,0010)	Clinical
Patient ID	(0010,0020)	Clinical
Patient's Birth Date	(0010,0030)	Clinical
Patient's Age	(0010,1010)	Clinical



Attribute	Tag	Requirement
Operators' Name	(0008,1070)	Clinical
Manufacturer	(0008,0070)	Investigative
Institution Name	(0008,0080)	Clinical
Institution Address	(0008,0081)	Investigative
Manufacturer's Model Name	(0008,1090)	Investigative
Device Serial Number	(0018,1000)	Investigative
Software Versions	(0018,1020)	Investigative
Station Name	(0008,1010)	Clinical
Contributing Sources Sequence	(0018,9506)	
>Acquisition DateTime	(0008,002A)	Clinical
>Detector ID	(0018,700A)	Investigative
>Date of Last Detector Calibration	(0018,700C)	Investigative

#### 4.16.4.2.2.1.3.5.2 Annotation of Technical Factor Information

6050 Image Displays shall fulfill the requirements defined in Section 4.16.4.2.2.1.1.5.2 for the attributes in Table 4.16.4.2.2.1.3.5.2-1:

**Table 4.16.4.2.2.1.3.5.2-1: Technique Attributes for Display**

Attribute	Tag	Notes
X-Ray 3D Acquisition Sequence	(0018,9507)	
>KVP	(0018,0060)	
>Exposure in mAs	(0018,9332)	
>Exposure Time in ms	(0018,9428)	
>Filter Material	(0018,7050)	
>Anode Target Material	(0018,1191)	
>Compression Force	(0018,11A2)	
>Body Part Thickness	(0018,11A0)	
>Primary Positioner Scan Start Angle	(0018,9510)	Used to derive the angle of the center of the arc. For additional information on angles see also DICOM CP 1282 (final text).
>Primary Positioner Scan Arc	(0018,9508)	
>Entrance Dose in mGy	(0040,8302)	
>Organ Dose	(0040,0316)	
Image Type	(0008,0008)	Used to display a human readable value of Value 4 for a derived image, e.g., if Value 4 is GENERATED_2D, a string such as "Generated 2D" might be displayed.
X-Ray 3D Reconstruction Sequence	(0018,9530)	

Attribute	Tag	Notes
>Reconstruction Description	(0018,9531)	

#### 4.16.4.2.2.1.3.5.3 Annotation of View Information

6055 Image Displays shall provide a mechanism to annotate view information as described in Section 4.16.4.2.2.1.1.5.3, except that the orientation information shall be obtained from Image Orientation (Patient) (0020,0037), see Section 4.16.4.2.2.1.3.2 Image Orientation and Justification.

6060 For images encoded using the Breast Tomosynthesis Image IOD the Image Display shall derive the abbreviations displayed in the viewport from View Code Sequence (0054,0220), View Modifier Code Sequence (0054,0222) and Frame Laterality (0020,9072) in the Frame Anatomy Sequence (0020,9071) of the Shared Functional Groups Sequence (5200,9229).

#### 4.16.4.2.2.1.3.5.4 Annotation of Frame Information

Image Displays shall fulfill the following annotation requirements:

- 6065 • Frames shall be numbered from 1 to Number of Frames (0028,0008) corresponding to the encoded order of the Frames in Pixel Data (7FE0,0010). For each frame the annotation shall show the current frame number and the number of frames.
- 6070 • For tomosynthesis frames, the thickness in mm of the frame based on the Slice Thickness (0018,0050) within Pixel Measures Sequence (0028,9110) of the Shared Functional Groups Sequence (5200,9229) or Per-frame Functional Groups Sequence (5200,9230) shall be displayed.
- For tomosynthesis frames the position within the stack of frames shall be displayed. The position shall be computed from the Image Position (Patient) (0020,0032) distance along the normal to the Image Orientation (Patient) (0020,0037) with an indication of the patient-relative direction along that normal (e.g., lateral to medial, head to foot).

#### 6075 4.16.4.2.2.1.3.6 Annotation of Size Information

For the purpose of this section, physical pixel size is as defined in Section 4.16.4.2.2.1.3.3. Image Displays shall fulfill requirements defined in Section 4.16.4.2.2.1.1.6.

6080 Note: For tomosynthesis frames, the reported distance measured will be based on actual size within the patient estimated during the reconstruction process, and may not be directly comparable with size measured from conventional 2D mammography images or generated 2D images.

#### 4.16.4.2.2.1.3.7 Partial View Option

6085 Image Displays supporting the Partial View Option in the Digital Breast Tomosynthesis Profile shall fulfill all requirements listed in Section 4.16.4.2.2.1.1 for tomosynthesis slices, projection images (if the For Presentation Breast Projection X-Ray Images Option is supported), and generated 2D images.

#### **4.16.4.2.2.1.3.8 Accidental Reading of Prior Studies**

6090 Requirements defined in Section 4.16.4.2.2.1.1.10 shall apply to Image Displays in the Digital Breast Tomosynthesis Profile as well. The Acquisition DateTime (0008,002A) attribute in the Contributing Sources Sequence (0018,9506) (see Table 4.8.4.1.2.7-3) shall be used to determine the display of a warning message, if no studies are within a configurable period from the current real time.

#### **4.16.4.2.2.1.3.9 Scrolling through Multi-frame Tomosynthesis Images**

6095 Image Displays shall be able to present tomosynthesis images in the viewport as a similar conventional 2D mammography view might be displayed. The tomosynthesis images are multi-frame. Accordingly, the user shall be provided with a means to scroll through the frames (such as one might scroll through a set of CT or MR slices).

Two modes of scrolling, manual and automatic (cine), shall be provided. For the automatic mode, the user shall be provided with control over the cine speed (frame rate) and the initial speed shall be configurable.

6100 **Note:** It is recommended that the maximum speed of scrolling be rapid so as to take advantage of the human visual system's sensitivity to motion in order to detect subtle abnormalities. It is beyond the scope of this transaction to specify a hardware performance target, but a maximum scrolling rate of at least 25 frames per second for an entire 5 MP display is desirable.

6105 The user shall have control over the cine playback sequencing such that they may choose looping, sweeping or stopping (see definitions in DICOM [PS3.3 C.7.6.5 Preferred Playback Sequencing](#) (0018,1244), even though this attribute is not used).

The Image Display shall not skip slices during manual or automatic scrolling.

**Note:** I.e., if the Image Display is unable to keep up with the user's requested frame rate, then the display will show all slices rather than scrolling faster.

6110 Scrolling between tomosynthesis frames shall be available regardless of the arrangement of the display and the combination with other views, whether the other views are tomosynthesis slices, conventional 2D mammography images or generated 2D images.

Scrolling shall be in spatial sequence according to Image Position (Patient) (0020,0032) for a given volume within a viewport.

6115 **Note:** If both tomosynthesis slices and slabs are displayed in a single viewport, they are two separate volumes displayed sequentially (i.e., not interleaved).

Scrolling shall be controllable using both a pointing device and the keyboard.

6120 Vertical movement of a conventional pointing device (such as a mouse) upward shall scroll toward the paddle (i.e., away from the detector). Touch screen pointing devices should scroll in the opposite direction.

#### **4.16.4.2.2.1.3.10 For Presentation Breast Projection X-Ray Images Option**

Image Displays supporting the For Presentation Breast Projection X-Ray Images Option shall fulfill the requirements defined in the following subsections for breast projection X-Ray images:

- Section 4.16.4.2.2.1.3.1 Background Air Suppression
- 6125 • Section 4.16.4.2.2.1.3.2 Image Orientation and Justification  
For breast projection X-Ray images, the Image Display shall use the View Code Sequence (0054,0220), View Modifier Code Sequence (0054,0222) and Frame Laterality (0020,9072) in the Frame Anatomy Sequence (0020,9071) of the Shared Functional Groups Sequence (5200,9229) together with Image Orientation (Patient) (0020,0037) in the Plane Orientation Sequence (0020,9116) of the Shared Functional Groups Sequence (5200,9229) to display images according to the preferred hanging protocol of the current user.
- 6130
- Section 4.16.4.2.2.1.3.3 Image Size  
For breast projection X-Ray images, size information shall be obtained from Imager Pixel Spacing (0018,1164) and Estimated Radiographic Magnification Factor (0018,1114).
- 6135
- Section 4.16.4.2.2.1.3.4 Image Contrast Adjustments
- Section 4.16.4.2.2.1.3.5 Annotation of Image Information including Section 4.16.4.2.2.1.3.5.3 Annotation of View Information
- 6140
- Section 4.16.4.2.2.1.1.5.1 Annotation of Identification Information, using Acquisition DateTime (0008,002A)
- Section 4.16.4.2.2.1.1.5.2 Annotation of Technical Factor Information using the attributes defined in Table 4.16.4.2.2.1.3.10-1:

**Table 4.16.4.2.2.1.3.10-1: Technique Attributes for Display**

Attribute	Tag	Note
KVP	(0018,0060)	
X-Ray Acquisition Dose Sequence	(0018,9542)	Located either in Per-frame Functional Groups Sequence (5200,9230) or in Shared Functional Groups Sequence (5200,9229)
>Exposure in mAs	(0018,9332)	
>Exposure Time in ms	(0018,9428)	
>Entrance Dose in mGy	(0040,8302)	
>Organ Dose	(0040,0316)	
X-Ray Filter Sequence	(0018,9556)	Located either in Per-frame Functional Groups Sequence (5200,9230) or in Shared Functional Groups Sequence (5200,9229)
>Filter Material	(0018,7050)	
Anode Target Material	(0018,1191)	
Compression Force	(0018,11A2)	
Body Part Thickness	(0018,11A0)	

Attribute	Tag	Note
Positioner Position Sequence	(0018, 9405)	Located either in Per-frame Functional Groups Sequence (5200,9230) or in Shared Functional Groups Sequence (5200,9229)
>Positioner Primary Angle	(0018,1510)	
>Positioner Primary Angle Direction	(0018,9559)	
Image Type	(0008,0008)	Used to display a human readable value of Value 3 to indicate projection images.

- 6145
- Section 4.16.4.2.2.1.3.5.4 Annotation of Frame Information
  - Section 4.16.4.2.2.1.3.6 Annotation of Size Information
- 6150 For breast projection X-Ray images, size information shall be obtained from Imager Pixel Spacing (0018,1164) in the Frame Pixel Data Properties Sequence (0018,9443) of the Shared Functional Groups Sequence (5200,9229) or Per-frame Functional Groups Sequence (5200,9230) and Estimated Radiographic Magnification Factor (0018,1114) in the X-Ray Geometry Sequence (0018,9476) of the Shared Functional Groups Sequence (5200,9229) or Per-frame Functional Groups Sequence (5200,9230).

6155 Breast projection X-Ray images are multi-frame rather than single-frame and therefore the user shall be provided with manual scrolling as defined in Section 4.16.4.2.2.1.3.9 Scrolling through Multi-frame Tomosynthesis Images; automatic scrolling (cine) is not required. Scrolling through breast projection X-Ray images shall be independent from scrolling through tomosynthesis frames.

#### 4.16.4.2.2.1.3.11 Display of DBT Images by the Viewer on the Media (Media Creation Option)

6160 The Media Creation Option of the Digital Breast Tomosynthesis (DBT) Profile groups an Acquisition Modality or Image Display with a Portable Media Creator in the Portable Data for Imaging (PDI) Profile, and allows for a viewer to be recorded on the media. That viewer is considered an Image Display for the purposes of this section and, the contents of this section are required for all such viewers recorded on media by actors claiming the Media Creation Option of the Digital Breast Tomosynthesis (DBT) Profile.

The Image Display shall be capable of displaying all SOP instances recorded on the media that are of the SOP Classes specified in Section 4.16.4.1.3.7. In addition, the Key Object Selection Document Storage SOP Class and Grayscale Softcopy Presentation State Storage SOP Class shall be supported if such instances are present on the media.

6170 The Media Creation Option of the Digital Breast Tomosynthesis (DBT) Profile defines a simplified set of functions for the Image Display to make available to the user with the intent of being able to perform basic review of individual or pairs of images encoded in any of the SOP

- Classes supported by the Digital Breast Tomosynthesis (DBT) Profile, as well as Key Image Notes and annotations, grayscale contrast and spatial transformations in Presentation States.
- 6175 Additional features may be present.
- The Image Display shall provide a means of selecting a single patient to display when more than one patient's studies are recorded on the media. When only a single patient is recorded, there is no need for a patient selection mechanism.
- The Image Display shall provide some means of selecting which images to display.
- 6180 The Image Display shall allow at least two images of any of the supported SOP Classes for the same or different studies to be compared side by side in separate viewports (to allow for comparison of different images of the current or prior studies). The Image Display shall allow display of only a single image in a single viewport (in order to take advantage of limited screen space).
- 6185 The Image Display shall fulfill all requirements listed in Section 4.16.4.2.2.1.1 related to the application of window/level and VOI LUTs present in the images and any Presentation States present on the media. Contrast adjustments as described in Section 4.16.4.2.2.1.3.4 shall be supported.
- Background air suppression as defined in Section 4.16.4.2.2.1.3.1 shall be supported.
- 6190 Image Displays shall apply image orientation and justification requirements as described in Section 4.16.4.2.2.1.3.2.
- The physical size of pixels for the purpose of annotations and measurements shall be obtained as described in Sections 4.16.4.2.2.1.3.3 and 4.16.4.2.2.1.1.3.
- 6195 There is no requirement for Same Size, True Size or View Actual Pixels display, but the Image Display shall provide continuous (not stepped) zooming and panning of an image displayed in a viewport.
- The Image Display shall provide scrolling through multi-frame images as described in Section 4.16.4.2.2.1.3.9, except that only manual, not automatic, scrolling is required.
- 6200 The Image Display shall provide annotation of the displayed images as described in Section 4.16.4.2.2.1.3.5 and its subsections, and annotation of size information as described in Section 4.16.4.2.2.1.3.6.
- There is no requirement for specific behavior for partial view images.
- The Image Display shall provide a tool to measure distance in a straight line between two user-defined points. There is no requirement to be able to save such measurements.
- 6205 The Image Display shall provide the user with the ability to select Key Images if Key Image Notes are present on the media, as defined in the Key Image Note Profile.
- The Image Display shall provide the user with the ability to select and apply Presentation States if Grayscale Softcopy Presentation State Storage instances are present on the media, as defined in the Consistent Presentation of Images (CPI) Profile, except that calibration of the display to

6210 the GSDF is not required since the Portable Media Creator that records the Image Display on the media has no control over the viewing environment in which the Image Display will be used.

#### **4.16.4.2.2.2 Display of Localizer Lines**

6215 Image Display or Imaging Document Consumer Actors that want to show the localizer lines, if visible, will be able to calculate the position of these lines of intersection based on the information recorded in the images by the Acquisition Modality (see Section 4.8.4.1.2.1).

#### **4.16.4.2.2.3 Display of NM Images**

The contents of this section are required for Image Displays claiming the NM Image Profile.

6220 The following requirements are intended to establish a baseline level of capabilities. Providing more intelligent and advanced capabilities is both allowed and encouraged. The intention is to focus on display capabilities, not to dictate implementation details.

Note that the NM Image Profile is undergoing revision, and vendors considering implementation are advised to include the modifications contained in the trial implementation version “NM Image Profile with Cardiac Option”. For additional information please contact the IHE Radiology Technical Committee at [ihe-rad-tech@googlegroups.com](mailto:ihe-rad-tech@googlegroups.com).

6225 Some examples of display behaviors typical to NM are described in RAD TF-1x: Appendix E.5.3.

The NM Image IOD is a multi-frame image indexed by vectors as described in Section 4.8.4.1.2.2.1. “Image” will be used here to strictly refer to the IOD, while frame will be used to refer to the usual two-dimensional array of pixels.

6230 The Image Display shall be able to display the frames in the order they are stored in the image.

The Image Display shall be able to perform the frame selections shown for each Image Type in the Table 4.16-1 and as described below in Section 4.16.4.2.2.3.1 Frame Selection Support. The result of a frame selection will be referred to as a “frameset” in this document. Note that a frameset only references frames from a single Image.

6235 The Image Display shall be able to display simultaneously multiple framesets. These may be from the same Image, different Images, different Series, or different Studies.

The Image Display is not required to display simultaneously multiple framesets with different Image Types. (Note that two exceptions to this are identified in Section 4.16.4.2.2.3.5 Review Option).

6240 The Image Display shall be able to display simultaneously at least the number of framesets indicated in Table 4.16-1.

All frames in the displayed frameset(s) are not required to be on the screen at once; if there are more frames than fit on the screen based on the current frame display size (see Section 4.16.4.2.2.3.4 Image Zoom), the ability to scroll through the frames is required.

6245 The Image Display shall be able to display, if present, the View Code Sequence (0054,0220), Acquisition Context Sequence (0040,0555), Series Description (0008,103E) and Acquisition Time (0008,0032) values for a given frameset.

The Image Display is required to support the display capabilities for each Image Type shown in Table 4.16-1.

6250 **Table 4.16-1. Selection, Sorting and Viewing Requirements for NM Images**

Image Type (0008,0008) Value 3	Frame Increment Pointer (0028,0009) [i.e., vectors]	Required Frame Selection <sup>1</sup> E = single <u>E</u> = all	Display Capabilities (See Section 4.16.4.2.2.3.2)	# of Simultaneous Framesets	
				General NM Option	Cardiac NM Option
STATIC	Energy Window (0054,0010) Detector (0054,0020)	<u>ED</u> See Note 2 <u>E D</u>	Grid Display	1	1
			Fit Display	12	12
WHOLE BODY	Energy Window(0054,0010) Detector(0054,0020)	<u>ED</u> See Note 2 <u>E D</u>	Whole body Display	2	-
DYNAMIC.	Energy Window (0054,0010) Detector (0054,0020) Phase (0054,0100) Time Slice (0054,0030)	<u>EDPT</u> See Note 3 <u>E D P T</u> <u>E D P T</u>	Grid Display	1	1
			Cine	1	1
GATED	Energy Window (0054,0010) Detector (0054,0020) R-R Interval (0054,0060) Time Slot (0054,0070)	<u>EDIT</u>	Grid Display	1	1
			Cine	3	6
TOMO	Energy Window (0054,0010) Detector (0054,0020) Rotation (0054,0050) Angular View (0054,0090)	<u>EDRA</u>	Grid Display	1	1
			Cine	3	3
GATED TOMO	Energy Window(0054,0010) Detector (0054,0020) Rotation (0054,0050) R-R Interval (0054,0060) Time Slot (0054,0070) Angular View (0054,0090)	<u>EDRITA</u> The following are optional: <u>EDRIT A</u> <u>EDRIT A</u>	Grid Display	1	1
			Cine	1	3
RECON TOMO	Slice (0054,0080)	<u>S</u>	Grid Display	1	1



Image Type (0008,0008) Value 3	Frame Increment Pointer (0028,0009) [i.e., vectors]	Required Frame Selection <sup>1</sup> E = single <u>E</u> = all	Display Capabilities (See Section 4.16.4.2.2.3.2)	# of Simultaneous Framesets	
				General NM Option	Cardiac NM Option
			ACC NM Cardiac Display		2
GATED RECON TOMO	R-R Interval (0054,0060) Time Slot (0054,0070) Slice (0054,0080)	<b><u>I T S</u></b> See Note 4 <b><u>I T S</u></b> <b><u>I T S</u></b>	Grid Display	1	1
			ACC NM Cardiac Display with Cine		2

**Note 1:** The Frame Selection column refers to the Frame Increment Pointer vectors by their first letter (except for R-R Interval which uses “I” for Interval). A letter shown underlined and bold (e.g., **E**) indicates that all values for that vector are selected. A letter shown in plain text (e.g., E) indicates that a single value for that vector has been selected. So in the case of the TOMO Image Type, **E R D A** means that all frames of the image are selected; while E R D A means that the selected frames represent all Angular Views for a specific Energy Window, a specific Detector and a specific Rotation. An asterisk (\*) indicates that it is required under the review option only, and not required under the basic NM Image Profile. For all image types, the ability to select and display all frames is required. For some image types, the ability to select subsets of frames (framesets) is required, as indicted in the table, in order to selectively adjust window levels or to limit the display to only that subset of images. It is preferable that this selection be performed by allowing the user to select frames based on the image vector information (e.g., selecting the “Technetium” energy window in a dual energy study, or selecting the “Anterior” images in a dual detector dynamic study). However, as specified in Notes 2-4 below, alternate methods that achieve the same goals are acceptable.

**Note 2:** In the case of a static or whole body image containing frames from two energy windows, the intensity of the two sets of frames may be very different, and some method to allow separate windowing of the two datasets is required in order to view them both simultaneously. his may be done by any suitable method, including allowing the user to explicitly select the frames from one energy window for subsequent windowing, allowing the user to select arbitrary individual frames for windowing, etc.,

**Note 3:** In the case of images containing dynamic frames from two detectors, it would be confusing for them to be displayed as a single dynamic cine (since it would flip back and forth between the two detectors). Therefore, some method of selecting a frameset for viewing purposes shall be provided. This may be done by any suitable method, including allowing the user to explicitly select the frames from one detector or orientation for display, allowing the user to select arbitrary consecutive frames for cine, showing anterior and posterior data as separate side-by-side cines, etc. Ability for the user to select specific phases of the study is also recommended, but not required. Note that orientation labels (such as Anterior/Posterior

Right/Left) should be shown if the information is available, as noted in the final paragraph of E.5.3.2.

6285 **Note 4:** Display of cardiac slice data at a single part of the cardiac cycle such, as display of end-diastolic and end-systolic frames (I T S), and display of slices in cine mode showing the heart beating (I T S) are required only under the Cardiac NM Option, and would likely be part of a dedicated cardiac display.

#### 4.16.4.2.2.3.1 Frame Selection Support

6290 A Frame Selection consists of either a single value, or “all values” being identified for each vector in the Image. In fact (except for the case of selecting “all frames” and the case of selecting all phases and time slices in a Dynamic Image) a single value will be identified for all but one of the available vectors.

6295 It is not necessary to require the user to specify a value for single valued vectors, such as when, for example, only a single detector value is present. It is desirable for the application to provide a way to make a selection when a vector that is *typically* single valued unexpectedly has additional values.

When selecting values for certain vectors, the user shall be presented with meaningful terms, if available, rather than the underlying integer values from the DICOM vector. For example, in the case of the detector vector, if the View Code Sequence it present, the terms contained there (e.g., “Anterior”, “Posterior”) shall be used instead of the Detector Number from the vector.

6300 The sources of selection terms in priority order (i.e., the first, if present shall be used, otherwise consider the next) are shown in the following table:

**Table 4.16-2: Sources of Value Selection Terms for Vectors**

Vector	Source of Selection Terms
Energy Window	1. Energy Window Name (0054,0018) 2. Energy Window Lower Limit (0054,0014) & Energy Window Upper Limit (0054,0015) 3. Energy Window Number
Detector	1. View Code Sequence (0054,0220) 2. Detector Number
Phase	1. Phase Description (0054,0039) 2. Phase Number
Rotation	1. Rotation Number
R-R Interval	1. R-R Interval Number
Time Slot	1. Time Slot Number
Angular View	1. Angular View Number
Slice	1. Slice Number

6305 One method of allowing the user to select a frameset by vectors might be to display a multi-vector image to the user as if it were broken down into its components by vector. For example, a 2-phase dual-detector GI bleed study might be shown to the user as

GI-bleed Phase-1 Anterior

GI-bleed Phase-1 Posterior

GI-bleed Phase-2 Anterior

GI-bleed Phase-2 Posterior

6310 This is acceptable as a means of frame selection support, provided the user has the option of selecting all the parts of the image for display as at the same time, should the user desire to do so, and provided that the multi-vectored image remains as a single image if it is sent via DICOM to another system.

#### **4.16.4.2.2.3.2 Display Capabilities**

6315 Image Displays are required to support the following display formats as indicated above in Table 4.16-1.

Practical examples of the usage and appearance of these display capabilities can be found in RAD TF-1x: Appendix E.5 NM Display and in particular in RAD TF-1x: Appendix E.5.3 NM Display Examples.

#### **6320 4.16.4.2.2.3.2.1 Grid Display**

For Grid Display, the Image Display shall display a single frameset arranged in a 2D grid of frames.

#### **4.16.4.2.2.3.2.2 Fit Display**

6325 For Fit Display, the Image Display shall display several framesets simultaneously. Efficient use of screen space is encouraged. The Image Display is free to organize the frames any way that seems sensible. In the absence of other useful information, it is common to display them in order of acquisition time.

#### **4.16.4.2.2.3.2.3 Intentionally Left Blank**

#### **4.16.4.2.2.3.2.4 Whole Body Display**

6330 For Whole Body Display, the Image Display shall simultaneously display of both the anterior and posterior frames of an NM whole body image.

These images will typically be rectangular in shape (taller than wide) and are typically 256 x 1024 or 512 x 1024 in size. The display system should display them as rectangular frames (and not pad them to make them square).

#### **6335 4.16.4.2.2.3.2.5 Intentionally Left Blank**

#### **4.16.4.2.2.3.2.6 Cine Display**

The Image Display shall be able to display a cine of the selected frames as indicated by the order they are stored in the Image.

6340 The Image Display shall be capable of displaying cines of multiple framesets simultaneously as indicated above in Table 4.16-1.

When the framesets have the same number of frames, the Image Display shall be capable of displaying the cines in synchronization (i.e., the first frame of each frameset should display simultaneously, the second frame of each frameset should display simultaneously, etc.).

6345 The Image Display shall provide the ability to adjust intensity (as described below in Section 4.16.4.2.2.3.3) for each frameset independently. The ability to adjust intensity while a cine is running is useful but not required.

#### **4.16.4.2.2.3.2.7 ACC NM Cardiac Display**

6350 For ACC NM Cardiac Display, the Image Display shall meet the following requirements. (Additional information regarding this standardized display can be found in RAD TF-1x: Appendix E.5.3.3.)

The Image Display shall be capable of taking a cardiac short axis data set and generating the corresponding vertical long axis, and horizontal long axis data sets.

For each axis, multiple frames are displayed, in a left-to-right (preferred) or top-to-bottom format.

6355 When two SPECT image sets are compared, they should be displayed simultaneously as a series of frames, either one above the other (preferred) or one next to the other.

Short axis data shall be displayed as serial frames with the apical slices first, progressing from the cardiac apex to the base of the heart. The heart shall be displayed with the following orientation:

6360

Anterior wall  
Septum (heart) Lateral wall  
Inferior wall

6365 Vertical long axis data shall be displayed as serial frames with the septal slices first, progressing to the lateral wall. The heart shall be displayed with the following orientation:

6370

Anterior wall  
Base (heart) Apex  
Inferior wall

6375 Horizontal long axis data shall be displayed as serial frames with the inferior slices first, progressing to the anterior wall. The heart shall be displayed with the following orientation:

Apex  
Septum (heart) Lateral Wall  
Base

- 6380 Short axis slices shall be labeled to convey they are “Short axis, apex to base”.
- Vertical long axis slices shall be labeled to convey they are “Vertical long axis, septal to lateral”.
- Horizontal long axis slices shall be labeled to convey they are “Horizontal long axis, inferior to anterior”.
- 6385 Images with the value of "ATTN" (i.e., Attenuation Corrected) in Corrected Image (0028,0051) shall be labeled as such.
- Images with the value of "prone" in the Patient Orientation Modifier Code Sequence (0054,0412) shall be labeled as such.
- The Image Display shall allow the user to window the Stress data independently of the Rest data, such that windowing affects all displayed Stress frames in the short and long axis views.
- 6390 The Image Display shall allow the user to window the Rest data independently of the Stress data, such that windowing affects all displayed Rest frames in the short and long axis views.
- The Image Display shall allow the user to window both Stress and Rest simultaneously in a manner that preserves the relative scaling of the two datasets. In other words, when both images are selected and the desired window is changed, the changes shall occur in a proportional manner for each image.
- 6395
- Example: The stress image is displayed with a window settings of (0,100), corresponding to the lower and upper window levels. The rest image is displayed with window settings of (0,50). The user adjusts the stress upper level to yield a window setting of (0,120). The user then selects both the stress and rest images, and adjusts the windowing to perform a 10% background subtraction on both images simultaneously, resulting in (12,120) for the stress image set, and (5,50) for the rest image set. Thus, the relative scaling of the two images is preserved during this last adjustment.
- 6400
- If values for Window Width (0028,1051) and Window Center (0028,1050) are present in the short axis data, they may be used to determine initial window settings at time of display. It is likely that use of presentation states will become the preferred method for conveying this information in a future revision of the profile.
- 6405
- The Image Display shall allow the user to adjust the Stress and Rest frame positions so that corresponding frames are displayed. This typically appears as sliding one row of frames to the right or to the left.
- 6410 The display order of the data sets is critical for interpretation. Regardless of the order in which the data sets were selected by the user, the display order in the ACC NM Cardiac Display shall be determined by the Patient State (see Note 3 in Section 4.8.4.1.2.2). The display order for different Patient State values is as follows:
- 1) Cardiac Stress
  - 2) Resting, Reinjection
- 6415

3) Redistribution

4) Delayed Redistribution

If the user selects two data sets with the same Patient State, the display order is undefined.

The value of Patient State for each data set shall be displayed.

- 6420 Examples: A typical set of cardiac images will include one “Cardiac Stress short axis image”, and because it has highest precedence in the above list, it is placed into the first image position in the ACC NM Cardiac Display. Images are typically selected in pairs, and the pair of selected data sets will typically include a Cardiac Stress data set, which is therefore placed in the first position (“Stress”) in the ACC NM Cardiac Display, and a Cardiac Rest data set, which is placed
- 6425 in the second position (“Rest”) in the ACC NM Cardiac display. If the selected data sets consist of only a rest image and a redistribution image, then the rest image is placed into the first position, since it has the highest precedence.

#### 4.16.4.2.2.3.3 Intensity and Color

- 6430 NM clinical practice requires the ability to adjust the Upper and Lower Window Levels rather than the Window Center and Window Width. Refer to RAD TF-1x: Appendix E.5.1 for details on NM usage of intensity and color attributes.

For all images with a modality type of NM, the Image Display shall provide direct control over the Upper Window Level and the Lower Window Level display parameters independently from each other for both grayscale and pseudocolor display.

- 6435 This control shall be available for all frames as a group and for each frameset individually. Optionally is it also useful to support adjustment of individual frames.

Window Level values shall be translated into equivalent Window Width and Center values when stored in the image attributes.

- 6440 The Image Display shall be capable of effectively “inverting” the image (in the sense of switching between a MONOCHROME1 and MONOCHROME2 interpretation). The method is undefined. This requirement applies to grayscale image display only; it is not required for pseudo-color lookup tables.

If the Image Display supports a color screen, the following shall be supported:

- 6445 The Image Display shall support display of frames of grayscale Images using a pseudo-color lookup table.

The Image Display shall allow the user to select from a configured set of pseudo-color lookup tables. Simultaneous display of both grayscale and pseudo-color presentations is not required. Thus, selecting a color lookup table may change all displayed frames on the screen.

- 6450 The Image Display shall provide a method of adding new pseudo-color lookup tables. It is acceptable if this is only available to service engineers.

#### **4.16.4.2.2.3.4 Image Zoom**

The Image Display shall be capable of “zooming” the frames where zooming consists of resampling and displaying the frame at a larger or smaller matrix size. For example, re-sampling a 128x128 frame to create a 256x256 frame is referred to as a 2X zoom in this document.

6455 All zooming of NM images shall preserve the aspect ratio (that is, the same zoom factor shall be applied in both the x and y dimensions). The Image Display is free to use pixel replication or interpolation to perform image zooming.

Some guidelines on appropriate default display sizes and desirable zoom behaviors are provided in RAD TF-1x: Appendix E.5.2 NM Image Resizing.

#### **6460 4.16.4.2.2.3.5 MPR Option**

Image Displays claiming the MPR Option shall support the following display capabilities and those indicated in Table 4.16-1.

The Image Display shall be capable of resampling a set of slices to generate orthogonal slices in the other two planes (e.g., generating coronal and sagittal slices from a set of transverse slices).

6465 The Image Display shall support viewing of three orthogonal plane views at the same time and shall provide a method of navigating the volume (i.e., controlling the specific sagittal, coronal and transverse images shown). Examples of MPR Displays can be found in RAD TF-1x: Appendix E.5.3.1 Example Layouts.

6470 (The Cardiac NM Option also requires support for MPR resampling and display, however this is documented separately in Section 4.16.4.2.2.3.7)

#### **4.16.4.2.2.3.6 General NM Option**

Image Displays claiming the General NM Option shall support the display requirements indicated in the General NM Option column of Table 4.16-1.

6475 These requirements represent the basic display needs for general (i.e., non-cardiac) nuclear medicine.

#### **4.16.4.2.2.3.7 Cardiac NM Option**

Image Displays claiming the Cardiac NM Option shall support the display requirements indicated in the Cardiac NM Option column of Table 4.16-1.

6480

These requirements represent the basic display needs for cardiac nuclear medicine.

6485 The Cardiac NM Option requires the ability to perform multiplanar reconstruction (MPR) of two re-oriented (short axis) cardiac RECON TOMO data sets to display the data in the standard format endorsed by the American College of Cardiology (ACC NM Cardiac Display). The ability to display more than two short axis data sets at the same time in the ACC Cardiac Display format is occasionally useful, but not required.

#### **4.16.4.2.2.4 Display of Result Screens**

6490 The contents of this section are required for Image Displays claiming the NM Image Profile. Refer to Table 4.18-2 for the specific SOP Class UIDs of the IODs referenced here for use as Result Screens.

The Image Display shall be able to display DICOM Secondary Capture images (including specifically 8 and 16 bit monochrome and 24 bit RGB).

6495 The Image Display shall be able to display DICOM Multi-Frame Secondary Capture images (including specifically 8-bit monochrome and 24-bit True Color)

The Image Display shall be able to display result screens at their original pixel resolution. If the display size is equal to or greater than the size of the result screen, this should be done as the default. If the display size is less than the size of the result screen, this will require some sort of panning capability.

6500 The Image Display shall be able to scale result screens using a fixed aspect ratio. If the display size is smaller than the size of the result screen, this should be done to fit the result screen onto the display as the default.

6505 For Multi-Frame Secondary Capture images which contain a Cine module, the Image Display shall be able to cine the frames. The default cine rate shall be the value in the Cine module, or the maximum rate of the Image Display, whichever is slower.

#### **4.16.4.2.2.5 Intentionally Left Blank**

#### **4.16.4.2.2.6 Display of Images for Basic Image Review**

6510 The contents of this section are required for all Image Displays claiming the Basic Image Review Profile. Additional requirements for Image Display actors included on PDI media by Portable Media Creators that support the Basic Viewer Option are described in the Portable Data for Imaging Profile (see RAD TF-1: 15.6).

##### **4.16.4.2.2.6.1 Simple Restricted Feature Set**

6515 The Basic Image Review Profile defines a specific, simplified set of functions for the Image Display to make available to the user, using only the prescribed user interface elements in this Section 4.16.4.2.2.6.

This shall be the default presentation.

Additional features may be present, but in order to reduce confusion these shall not be displayed to the user, unless the user specifically selects a tool to trigger advanced functionality.

6520 With a multi-button mouse, the functions of the left mouse and middle scroll wheel are defined. The right mouse button shall be inactive or bring up a context sensitive menu (whose contents are unspecified).



#### 4.16.4.2.2.6.2 Layout, Tiling, Selection, Rotation and Flipping

Layout and navigation are defined with respect to “FrameSets”.

Each DICOM image instance is a separate FrameSet, with two exceptions:

- 6525     • a Series of only single frame instances comprises a single FrameSet
- the combined frames of a Concatenation comprise a single FrameSet (if Concatenations are supported, which they are not required to be)

This means that when a Series contains a mixture of single frame and multi-frame images, in order to preserve sequence of images within a Series:

- 6530     • each successive single frame image will be a separate FrameSet consisting of one frame
- each multi-frame image will be a separate FrameSet (except for combined images of a Concatenation, if supported)

Furthermore, there will never be fewer FrameSets than Series (i.e., Series will not be combined).

- 6535     For the specific case of dual-echo MR images, in which slices of different acquisition contrast (PD and T2) may be interleaved within the same FrameSet, the slices shall be separated by Echo Number (0018,0086) into two separate FrameSets.

See RAD TF-2x: Appendix Q for informative examples of organization of series and images into frame sets.

- 6540     Whether or not an image is “single frame” or “multi-frame” is independent of the actual SOP Class and IOD of the image. A “single frame image” is defined to be one in which Number of Frames (0028,0008) is absent, or present with a value of one. A “multi-frame image” is defined to be one in which Number of Frames (0028,0008) is present and has a value greater than one.

The initial default layout shall include:

- a strip or panel of FrameSet thumbnails (see Section 4.16.4.2.2.6.3 Navigation)
- 6545     • after the user selects the FrameSet to display, one or more viewports open, each with a single tile populated with an appropriate default image from a default FrameSet (e.g., the first or middle image of the first FrameSet), full image size scaled to fit the tile, appropriately windowed (see Section 4.16.4.2.2.6.4 Windowing and Rendering) and appropriately decorated with annotations (see Section 4.16.4.2.2.6.8 Annotation of Demographics, Location, Timing and Technique) and with the Scrolling tool activated
- 6550     • a toolbar, palette or panel of tools to access the functions described in Section 4.16.4.2.2.6 using the icons described in Section 4.16.4.2.2.6.13
- optionally, a tool to trigger a change in layout to “advanced” functionality

- 6555     For studies that contain multiple FrameSets that are not spatially correlated, the default shall be display of a single FrameSet in a single viewport.

For studies that contain multiple FrameSets of spatially correlated information (e.g., multiple transverse MR FrameSets), the default shall be display of two FrameSets in side by side

viewports. If the FrameSets share the same DICOM Frame of Reference UID, the viewports shall by default

- 6560
- be synchronized with respect to scrolling (see Section 4.16.4.2.2.6.5 Scrolling),
  - be synchronized with respect to panning and zooming (see Section 4.16.4.2.2.6.6 Zooming and Panning),
  - have cross-referencing active (see Section 4.16.4.2.2.6.7 Laterality and Spatial Cross-Referencing)

6565 Which two spatially correlated FrameSets to choose for the default is at the discretion of the implementer.

A Layout Multiple Viewports tool shall be provided to allow the user to select the number and arrangement of the viewports. At least two layouts shall be supported:

- a single viewport, and
- 6570
- two vertical viewports side by side.

A Layout Within Viewport tool shall be provided to allow the user to select the number and arrangement of image tiles within each viewport. At least four layouts shall be supported:

- a single tile,
  - two vertical tiles side by side,
- 6575
- two horizontal tiles one above the other, and
  - four tiles in a grid.

The Layout Within Viewport tool shall be inactive if the selected viewport contains a FrameSet that has only one frame (i.e., multi-frame image that has only one frame, or series of single frame images that have only one image).

6580 The Image Display shall provide tools to rotate images with a Modality (0008,0060) of DX or CR displayed in the selected viewport by 90 degree increments, and to flip them horizontally. These tools shall be inactive for other modalities, for safety reasons.

#### **4.16.4.2.2.6.3 Navigation**

6585 The Image Display shall provide a means of selecting the single patient to display for contexts in which a selection needs to be made between different patients for display (e.g., when the Image Display is communicating with an Image Archive).

For contexts in which only one patient is available (e.g., when the Image Display is executed from PDI media on which data for only a single patient is recorded), there is no need for a patient selection mechanism.

6590 The Image Display shall not display FrameSets for multiple patients simultaneously. Only images with exactly the same value for Patient's ID (0010,0020) and Patient's Name (0010,0010) shall be displayed at the same time (other Patient-level attributes may be different,

6595 empty or absent). Though it is possible that the same patient may have slightly different identifying attributes in different DICOM images performed at different sites or on different occasions, it is expected that such differences will have been reconciled prior to the images being provided to the Image Display (e.g., in the Image Manager/Archive or by the Portable Media Creator).

6600 The Image Display may provide some means of selecting (manually, or automatically based on similarity rules) a sub-set of studies for which to provide FrameSet thumbnails when multiple studies are available for the same patient; otherwise thumbnails shall be provided for all FrameSets.

The Image Display shall allow at least two FrameSets for the same or different studies to be compared side by side in separate viewports (to allow for comparison of different modalities or current or prior studies).

6605 The Image Display shall allow display of only a single FrameSet in a single viewport (in order to take advantage of limited screen space), and a single FrameSet in two viewports (in order to view them with different window levels).

6610 The Image Display shall provide thumbnails for each FrameSet for the purpose of providing a Gestalt overview of all FrameSets available for all studies for the same patient, and allowing the user to select (navigate to) a particular FrameSet for display. These thumbnails shall:

- be of sufficient size to be recognizable (no less than 128x128 pixels)
- be representative of the image content of the FrameSet (e.g., down-sampled from the central frame of a FrameSet)
- 6615 • be decorated with text describing the Series Date (or if absent, Study Date), Modality and Series Description derived from the standard DICOM attributes, and a count of the number of frames in the FrameSet (i.e., images in the series, in the case of single frame images)
- 6620 • be arranged within a scrolling strip or panel which is visible by default (though optionally a mechanism may be provided for the user to hide the thumbnail strip or panel to minimize encroachment on available screen real estate for display)
- be sorted by ascending temporal order of study, and then ascending temporal or ascending Series Number within a study, and then ascending temporal order of FrameSets within a series

The text decoration may overlay the thumbnail image, or appear above or below it.

6625 The Image Display shall allow the user to:

- double-click over a thumbnail to load the corresponding FrameSet for display in the currently selected viewport (replacing any FrameSet already displayed)
- 6630 • CTRL-click (Windows) or Command-click (MacOS) discontinuous thumbnails to allow selection of two (or optionally, more) FrameSets which, after a double-click, will be displayed in the currently open viewports, or newly opened viewports (see also Layout)

- SHIFT-click contiguous thumbnails to allow selection of two (or optionally, more) FrameSets which, after a double-click, will be displayed in the currently open viewports, or newly opened viewports (see also Layout)

6635 The Image Display shall not permit the user to select more FrameSets than can be displayed in viewports.

Other mechanisms, such as drag-and-drop, may be provided at the implementer's discretion.

In addition to the thumbnail navigation, specific toolbar icons shall be provided for:

- previous and next study
- previous and next FrameSet
- 6640 • previous and next image or frame within a FrameSet

that apply to the currently selected viewport (see Section 4.16.4.2.2.6.13).

The previous and next study are defined relative to ascending temporal order of the studies.

The previous and next FrameSet are defined relative to ascending Series Number within a study then ascending temporal order of the FrameSets within a series.

6645 The previous and next image or frame within a FrameSet for cross-sectional slices are defined relative to anatomical spatial position, then for each spatial position by time of acquisition. The previous and next image or frame within a FrameSet for other slices are defined relative by ascending Instance Number or sequential frame order.

6650 Within a displayed FrameSet, cross-sectional slices shall be sorted by anatomical spatial position, then for each spatial position by time of acquisition, and other slices shall be sorted by ascending Instance Number or sequential frame order.

#### **4.16.4.2.2.6.4 Windowing and Rendering**

6655 The default when grayscale images are displayed in a viewport shall be to use the first set of VOI LUT or window values supplied in the DICOM attributes. If VOI LUT or window values are absent, either a default based on statistical analysis of pixel values, or a modality-specific appropriate preset such as soft tissue preset for CT images shall be used.

For grayscale images, a tool shall be provided to select the use of the mouse to window the images in all tiles of the currently selected viewport. This support shall include:

- 6660 • a tool that selects windowing by mouse movement with the left (or only) mouse button held down
- acceleration of the rate of windowing by a keyboard modifier or detection of the rate of mouse movement

Another tool is provided to toggle between two modes of windowing behavior, Center/Width and Clamped.

6665 When the Window tool is selected and the mode is Center/Width:

- horizontal movement of the mouse to the right will widen the window width (flatten the perceived contrast)
- vertical movement of the mouse upwards will lower the window center (increase the perceived brightness)

6670 When the Window tool is selected and the mode is Clamped:

- the bottom of the window shall be clamped to a rescaled pixel value of 0
- vertical movement upward shall lower the upper limit of the window (increase the perceived brightness)

6675 Clamped mode shall be the default for NM and PET images. When Clamped mode is selected, if the DICOM provided or currently applied lower limit of the window is not zero, it shall be set to zero.

There is no requirement to synchronize windowing between different viewports.

The currently applied window center and width for each viewport shall be displayed at all times, either in a status bar or in an overlaid corner annotation.

6680 Window selection by the user (whether by default, preset or manual adjustment) shall be preserved when scrolling through images in a series, and scrolling frames within a multi-frame image and for display of multiple tiles in a viewport.

6685 For CT images in Hounsfield Units, user-selectable window presets shall be provided which shall include presets for soft tissue, brain, lung and bone. Others may be provided at the implementer's discretion.

6690 For other modalities for which the pixel intensity does not correspond to a defined range of physical units, and hence for which no user-selectable window presets can be defined, a default derived from the statistical characteristics of the image (or series) shall be available that makes use of the range of actual pixel values in the image to apply a window that results in a usable display. For PET and NM images, this statistically-derived default shall have a lower level of zero. The default, preset and user selected windowing shall be applicable to grayscale images of any bit depth greater than one, whether signed or unsigned (including 8 bit images). The window range shall be able to be extended beyond the pixel value range.

6695 There is no requirement to be able to apply a pseudo-color palette to grayscale images (those with a Photometric Interpretation of MONOCHROME1 or MONOCHROME2), but this ability may be included at the implementer's discretion.

6700 On a color monitor, the Image Display shall be able to display color images (those with a Photometric Interpretation of RGB or PALETTE COLOR), and images that have a Planar Configuration of 0 or 1. There is no requirement to be able to control the contrast or brightness of a color image.

The grayscale rendering pipeline shall be appropriate to the SOP Class and modality. If Rescale Slope and Rescale Intercept are present in the image for MR and PET and XA/XRF images, they

shall be ignored from the perspective of applying window values, and for those SOP Classes, window values shall be applied directly to the stored pixel values without rescaling.

6705 If VOI LUT tables or functions are specified in the DICOM images, then the requirements of Section 4.16.4.2.2.1 Display of Digital X-Ray, Mammo and Intra-Oral Images shall apply; the Basic Image Review Profile does not waive those requirements; further, the Basic Image Review Profile extends these requirements to be applicable to any SOP Class with VOI LUT tables or functions, including CR images.

6710 Stored pixel values between Pixel Padding Value and Pixel Padding Range inclusive shall be suppressed, always displayed as black and not windowed.

Display shutters encoded in the image shall be applied. There is no requirement to provide new or adjustable display shutters.

6715 An invert grayscale tool shall be provided. It shall invert the displayed pixels but not the pixel padding background or shutters.

#### **4.16.4.2.2.6.5 Scrolling**

The Image Display shall provide support for scrolling in the currently selected viewport between images when multiple single frame images are present in a series, and between frames when multiple frames are present in a single image (i.e., frames within a FrameSet).

6720 This support shall include:

- a Scroll tool that selects scrolling by mouse movement with the left (or only) mouse button held down
- acceleration of the rate of scrolling by a keyboard modifier or detection of the rate of mouse movement
- scrolling via the middle scroll wheel on a mouse if present on the hardware, regardless of the left mouse button tool selection

6725

Unaccelerated scrolling shall not skip frames.

Vertical movement of the mouse upwards for cross-sectional images shall scroll to slices physically behind the current slice, that is:

- 6730
- scroll towards the patient's head for transverse images viewed from inferiorly
  - scroll towards the patient's posterior for coronal images viewed from anteriorly
  - scroll towards the patient's right for sagittal images viewed from the left

Vertical movement of the mouse upwards for other images shall:

- 6735
- scroll towards earlier frames of a multi-frame images
  - scroll towards lower Instance Numbers in a series of single frame images

For cross-sectional images in the same DICOM Frame of Reference as the images in the currently selected viewport, scrolling shall be synchronized between viewports based on three-

6740 dimensional location, unless unlinked. Note that this means that if the slice intervals are different in different FrameSets in the same plane, the scrolling may not appear to be at a uniform rate in different viewports. Interpolation between slices is not required by this profile, but may be included at the implementer's discretion. If the end of one FrameSet is reached during scrolling and another linked FrameSet has more slices, scrolling shall continue and the viewport displaying the exhausted FrameSet shall be shown as black.

Scrolling shall not loop around to the first slice at the end of the FrameSet.

6745 Synchronization between viewports shall apply whether a single frame is displayed or the viewport is tiled to display multiple frames.

The user shall be able to unlink synchronization between viewports, scroll one and then relink to a new synchronized position (e.g., if the patient has moved between FrameSets within the same nominal DICOM Frame of Reference).

6750 For cross-sectional images that are in the same orientation but not in the same DICOM Frame of Reference, the user shall be able to scroll them (if needed) to align them, and then link them for subsequent scrolling.

6755 When two cross-sectional images in the same orientation are displayed in different viewports, they shall default to the "linked" state if they have the same DICOM Frame of Reference, otherwise they shall default to the "unlinked" state.

Only one synchronized set shall be provided.

Scrolling when multiple tiles are displayed in a viewport, shall be "snaked", that is as the user advances one slice forward, all slices shift to the left and upwards as appropriate, but do not loop at either end of FrameSet.

#### 6760 **4.16.4.2.2.6.6 Zooming and Panning**

The Image Display shall provide continuous (not stepped) zooming and panning of an image displayed in a viewport.

A Zoom tool shall be provided to select zooming within the selected viewport by mouse movement with the left (or only) mouse button held down.

6765 Vertical movement of the mouse upwards shall decrease the magnification factor (i.e., "zoom out") and downwards shall increase the magnification factor (i.e., "zoom in"). Horizontal movement of the mouse when this tool is selected shall have no effect.

6770 A separate Pan tool shall be provided to select panning within the selected viewport with the left (or only) mouse button held down, left or right or up or down or diagonally in the direction of the mouse movement.

Interpolation for display shall be continuous (e.g., linear or bicubic) and not by nearest neighbor replication.

Both magnification and minification shall be supported.

6775 Zooming shall be synchronized across all spatially cross-referenced images, even if they are in different orientations. Panning shall be synchronized across all spatially cross-referenced images in the same orientation.

6780 The initial state when the image is loaded or the display reset shall be to scale the image size of the first series to fit its viewport size (without distortion of the pixel aspect ratio). For cross-sectional images in the same DICOM Frame of Reference displayed in other viewports, the same center three-dimensional location and magnification as the first viewport shall be applied (this provides an appropriate initial state for subsequent synchronized zooming, panning and scrolling).

6785 The user shall be able to unlink synchronization of panning and zooming between viewports, pan one and then relink to a new synchronized position (e.g., if the patient has moved between FrameSets within the same nominal DICOM Frame of Reference).

For images that are not spatially cross-referenced, the default state shall be unlinked zooming and panning.

#### **4.16.4.2.2.6.7 Laterality and Spatial Cross-Referencing**

6790 The Image Display shall display the laterality (the side of a paired body part unless unpaired or both parts displayed) in the overlaid annotations (see Section 4.16.4.2.2.6.8), and the value shall be obtained from Frame Laterality (0020,9072), Image Laterality (0020,0062) or Laterality (0020,0060) as appropriate for the SOP Class.

6795 The orientation of the rows and columns as derived from Image Orientation (Patient) (0020,0037) or if absent, explicitly specified in Patient Orientation (0020,0020), shall be annotated on the right and bottom sides of the viewport (and may also be annotated on the left and top side), and shall account for any rotation or flip applied.

The Image Display shall provide two means of cross-referencing cross-sectional slices with the same DICOM Frame of Reference that have not been unlinked, or unlinked, translated and re-linked, by the user.

6800 One means shall be to display localizer lines in which:

- if multiple viewports are displayed and the slices in the viewports are of orthogonal orientations
- the 3D location of the slice(s) in the currently selected viewport shall be displayed as a localizer line(s) on the other viewports
- 6805 • no localizer lines shall be displayed in the currently selected viewport.

A Localizer Lines tool shall be provided to turn the display of localizer lines on or off.

6810 These requirements for the Basic Image Review Profile supersede the general requirements for all Image Displays described in Section 4.16.4.2.2.2 Display of Localizer Lines. Specifically, the contents of Referenced Image Sequence (0008,1140) shall be ignored in favor of what the user has selected for display in the viewports.



Another means of cross-referencing shall be provided in which:

- 6815 • selection of a Cross-hair tool shall change the function of the left (or only) mouse button such that clicking on a pixel location within one viewport shall cause a crosshair to be displayed at that location in that viewport and at the corresponding 3D location in other viewports
- the cross-hair(s) shall consist of horizontal and vertical line segments, which
  - may or may not span the full extent of each viewport
  - are interrupted in the center so as not to obscure the image at the pixel location

6820 Though ability to display the location of a slice on an orthogonal image serves to indicate on what side of the body a sagittal slice is located by reference to a corresponding transverse slice, the Image Display shall also annotate sagittal images with a specific textual indication of whether or not a sagittal image is to the left of center or to the right of center (this can be computed by the viewer from Image Position (Patient) (0020,0032) and Rows (0028,0010), Columns (0028,0011) and Pixel Spacing (0028,0030) relative to the three-dimensional extent of 6825 the entire volume of all FrameSets).

#### **4.16.4.2.2.6.8 Annotation**

The Image Display shall display annotations in the corners of the viewport (and/or top window decoration of the view port). These annotations shall consist of the content of selected DICOM attributes appropriate to the SOP Class. The information required includes, but is not limited to:

- 6830 • Patient's Name (0010,0010), Patient's ID (0010,0020), Patient's Birth Date (0010,0030), Patient's Sex (0010,0040)
- Institution Name (0008,0080)
- Study ID (0020,0010) and Accession Number (0008,0050) (for correlation with study described in the report)
- 6835 • Series Number (0020,0011) (for correlation with series described in the report)
- Series Description (0008,103E)
- Acquisition Datetime (0008,002A), if present, else Acquisition Date (0008,0022) and Acquisition Time (0008,0032), if present, else Content Date (0008,0023) and Content Time (0008,0033), if present, else Series Date (0008,0021) and Series Time (0008,0031), 6840 if present, else Study Date (0008,0020) and Study Time (0008,0030)
- Instance Number (0020,0013) (for correlation with slices described in the report)
- Slice Location (0020,1041), if present, else Table Position (0018,9327), if present else a value derived from Image Position (Patient) (0020,0032)
- Slice Thickness (0018,0050)

- 6845
  - Spacing Between Slices (0018,0088), if present, else a value derived from successive values of Image Position (Patient) (0020,0032) perpendicular to the Image Orientation (Patient) (0020,0037)
  - whether or not intravenous contrast was used (C+/-), derived from Contrast/Bolus Agent Sequence (0018,0012), if present, else Contrast/Bolus Agent (0018,0010)
- 6850
  - whether or not lossy compression has been applied, derived from Lossy Image Compression (0028,2110), and if so, the value of Lossy Image Compression Ratio (0028,2112) and Lossy Image Compression Method (0028,2114), if present (as per FDA Guidance for the Submission Of Premarket Notifications for Medical Image Management Devices, July 27, 2000)
- 6855
  - the currently applied window center and width (or window top and bottom for clamped mode)

Local regulations or accreditation requirements may mandate additional information specific to particular modalities, but it is beyond the scope of IHE to define these.

- 6860 Annotations that are common to all viewports or tiles need not be displayed in every viewport or tile. The Image Display shall provide a tool to suppress the display of the annotations, and to minimize the annotations to just display patient's name and date of study.

#### **4.16.4.2.2.6.9 Cine**

- 6865 The purpose of the cine function is to allow a means of displaying a FrameSet that is a continuous temporal display, in addition to (not instead of) scrolling and stepping back and forth between individual frames. This is typically used as the primary means of displaying FrameSets that were acquired with a dimension of time in the first place (e.g., cardiac angiograms and echocardiography ultrasound), but is not confined to this use.

- 6870 The Image Display shall provide a cine function for the currently selected FrameSet (i.e., multi-frame image or currently selected series of single frame images (of the same size, i.e., the same values for Rows and Columns)), which allows the user to:

- play the frames as a continuously cycling loop, either forward or reverse
- stop, pause, step one frame, skip to first frame and skip to last frame

The Image Display shall provide an ability to control the frame rate (frames displayed per second). The default shall be the frame rate specified in the DICOM attributes, if present.

- 6875 The cine tools shall be invoked as a group by a single tool button, rather than all visible by default on the main tool bar or panel. The cine play shall immediately be initiated without requiring the user to press the play button. The cine tools shall remain available once activated until explicitly closed by the user.

- 6880 Cine of multiple viewports simultaneously is not required, but may be provided (e.g., for cardiac applications, in which synchronization by cardiac cycle position may also be useful).

Cine of a tiled viewport (“snaking cine”) shall not be used. If the cine tools are invoked on a tiled viewport, the viewport shall be changed to a single tile.

#### **4.16.4.2.2.6.10 Measurements**

6885 The Image Display shall provide measurement tools that allow multiple measurements to be made and remain displayed until the application is closed, or the Display Reset tool is applied to one or more selected viewports.

6890 The Image Display shall provide a tool to measure distance in a straight line between two points within the plane of the image (using Pixel Spacing (0028,0030), Imager Pixel Spacing (0018,1164), Nominal Scanned Pixel Spacing (0018,2010) or the Ultrasound Region Calibration Module as appropriate for the SOP Class of the image). Distance shall be reported in pixels rather than physical units if there is no spacing or calibration information in the image, otherwise the distance shall be reported in the units of the DICOM attribute used (mm in the case of pixel spacing attributes, and whatever units are specified for the Ultrasound Region).

6895 The precision of the measurement shall be one displayed pixel at the magnification factor applied to the image when the end points are placed by the user, i.e., the distance shall be measured with sub-image pixel resolution.

There is no requirement to attempt to account for geometric magnification in projection radiographs.

6900 The pixel spacing attributes account for non-square pixels, since the DICOM attributes define separate row and column spacing values, and this shall be accounted for in diagonal measurements.

6905 The Image Display shall provide a tool to measure the angle between two straight line segments, which do not necessarily share a common vertex. This allows Cobb angle to be measured rather than a three-point angle tool with a common vertex required. The angle shall be reported in degrees.

6910 At all times (except during cine), the scaled pixel value (physical unit) corresponding to the current cursor location shall be reported to the user (e.g., in the status bar). For example, the Hounsfield Unit value of a CT voxel or the SUV g/l value of a PET voxel would be displayed. The appropriate scale factors are SOP Class specific. Additional information (such as the 3D voxel location) may also be displayed, but is not required.

#### **4.16.4.2.2.6.11 Viewport and Tool Selection**

Some tools and actions require that there be one or more viewports that are “selected”, for example

- loading a FrameSet designated by a thumbnail into the selected viewport
  - linking or unlinking FrameSets for synchronized scrolling, zooming and panning
- 6915

A viewport is either:

- implicitly selected when any modal tool is clicked within a viewport

- explicitly selected with the Select Viewport tool

6920 Multiple viewports may be selected by holding the CTRL key (Windows) or COMMAND (Mac) key whilst clicking within a viewport when the Select Viewport mode is active.

The initial default shall be that the upper leftmost or only viewport is selected.

The Image Display shall provide visual feedback to the user as to which viewports are selected (e.g., a border highlight).

6925 Once a modal tool has been selected, it shall remain selected until the user explicitly selects another tool (e.g., when the distance measurement tool is selected, multiple measurements can be made without having to reselect the measurement tool).

Explicit selection of a viewport is not required prior to application of modal tools.

#### **4.16.4.2.2.6.12 Report Display**

6930 When used as the Basic Viewer Option on PDI Media, the Image Display shall provide a Show Report tool to display all content on the media that was identifiable by the Portable Media Creator as a report related to the DICOM images on the media.

Notes.

- 6935
1. There is no requirement that such reports be in a standard format, as long as the viewer can display them. It is expected that the Portable Media Creator might use DICOM Structured Reports, DICOM encapsulated PDF documents, DICOM encapsulated CDA<sup>®1</sup> documents, unencapsulated CDA documents encoded using ITI XDM Profile, CDA encapsulated PDF documents encoded using ITI XDS Scanned Document (XDS-SD) Profile, but this is entirely at the discretion of the Portable Media Creator.
  2. Some content on the media (e.g., reports scanned as DICOM Secondary Capture images) may not be clearly identifiable to the Portable Media Creator as reports, but would be displayed as ordinary images.
  - 6940 3. All of the reports on the media are displayed, regardless of whether the series to which they apply is currently displayed or not, since the reports may be in an unstructured format without meta-data to allow the application to determine to which series they apply.

#### **4.16.4.2.2.6.13 Tool Icons and Actions**

6945 The icon symbols described in this section are not intended to be used exactly with the bitmap illustrated, but rather used as a guide to build the implementers' own icons, as long as they are recognizable as being the same symbol. Some icons may require variants to indicate that it is in the activated (pressed) state, and these are not explicitly shown here, since it is up to the implementer's look and feel to provide a consistent pattern for this.

There are various classes of tools:

- 6950
- those that trigger an immediate action (Action Tools, described in Table 4.16.4.2.2.6.13-1)

---

<sup>1</sup> HL7 is the registered trademark of Health Level Seven International.

- those that change the function of the left (or only) mouse button and are related to the position of the pointing device and cursor (Modal Tools, described in Table 4.16.4.2.2.6.13-2)

6955

- those that control cine (Cine Tools, described in Table 4.16.4.2.2.6.13-3)

The Modal Tools that affect the function of the left (or only) mouse are mutually exclusive; the tool icons shall change appearance to indicate that they are selected, the cursor shall also change to convey to the user that the mode is active, and a cursor shape shall be used that is recognizably similar to the icon used to select the tool.

6960


All tool icons shall supply a tool tip that appears when the cursor dwells over the icon, which shall describe a) the function of the tool and b) the keyboard shortcut for the tool (if any).



Any operating system on the Image Display provides Key Repeat functionality. While this operating system feature may be useful for Previous/Next Study/Series/Image/Frame, the Image Display is not required or prohibited to make use of it.



6965






Keyboard short cuts shall be case insensitive.

**Table 4.16.4.2.2.6.13-1: Action Tool Icons Appearance and Action**





Tool	Icon Symbol	Icon Ref. or Desc.	Default State	Key	Action	Comments
Select Patient		Person	Single available patient is selected; if more than one patient, no patient is selected.	No default shortcut	Pressing this button shall bring up a mechanism to select which patient to display, in those contexts in which multiple patient information is available.	Shall be grayed out if there is only a single patient (e.g., on interchange media).




Tool	Icon Symbol	Icon Ref. or Desc.	Default State	Key	Action	Comments
Previous Study		Left facing arrow within folder	Not applicable	No default shortcut	Pressing this button shall cause the selected viewport to display the first frame the first FrameSet of the previous study, if any, and highlight the thumbnail of the newly selected FrameSet. The operating system enables character repeat for Previous Study.	Shall be grayed out if no previous study.
Next Study		Right facing arrow within folder	Not applicable	No default shortcut	Pressing this button shall cause the selected viewport to display the first frame of the first FrameSet of the next study, if any, and highlight the thumbnail of the newly selected FrameSet. The operating system enables character repeat for Next Study.	Shall be grayed out if no next study.





Tool	Icon Symbol	Icon Ref. or Desc.	Default State	Key	Action	Comments
Previous FrameSet		Left facing double arrow	Not applicable	Page Up	<p>Pressing this button shall cause the selected viewport to display the first frame of the previous FrameSet of the current study, if any, and highlight the thumbnail of the newly selected FrameSet.</p> <p>The operating system enables character repeat for Previous FrameSet.</p>	Shall be grayed out if no previous FrameSet.
Next FrameSet		Right facing double arrow	Not applicable	Page Down	<p>Pressing this button shall cause the selected viewport to display the first frame of the next FrameSet of the current study, if any, and highlight the thumbnail of the newly selected FrameSet.</p> <p>The operating system enables character repeat for Next FrameSet.</p>	Shall be grayed out if no next FrameSet.



Tool	Icon Symbol	Icon Ref. or Desc.	Default State	Key	Action	Comments
Previous Frame within a FrameSet		Left facing single arrow	Not applicable	Left arrow and Up arrow (single click of either; application shall support both)	Pressing this button shall cause the selected viewport to display the previous frame of the current FrameSet, if any. The operating system enables character repeat for Previous Frame within a FrameSet	Shall be grayed out if no previous frame.
Next Frame within a FrameSet		Right facing single arrow	Not applicable	Right arrow and Down arrow (single click of either; application shall support both)	Pressing this button shall cause the selected viewport to display the next frame of the current FrameSet, if any. The operating system enables character repeat for Next Frame within a FrameSet	Shall be grayed out if no next frame.
Layout Within Viewport		Single viewport with 2x2 tiles, with a dropdown decoration	1x1	No default shortcut	Pressing this button shall present a drop down of selected grid sizes to use within a single viewport.	See Section 4.16.4.2.2.6.2
Layout Multiple Viewports		Four viewports with 2x2 tiles, with a dropdown decoration	Depends on how many series selected for display	No default shortcut	Pressing this button shall present a drop down of selected grid sizes for multiple viewports.	See Section 4.16.4.2.2.6.2
Invert Grayscale		IEC 60878-2003 5411 "Reversal black-to-white"	Not inverted	No default shortcut	Clicking this button shall toggle the inversion state.	See Section 4.16.4.2.2.6.4





Tool	Icon Symbol	Icon Ref. or Desc.	Default State	Key	Action	Comments
Localizer lines		Person in a box (image) with a single dotted overlaid transverse line	Off	O (for “overlay”)	Selecting this tool shall toggle the display of localization lines on or off.	See Section 4.16.4.2.2.6.7 Shall be grayed out if no series are displayed on which to show localizer lines.
Link/unlink translation synchronization		Three links in a horizontal chain. Three links in a horizontal chain with the middle link visibly broken open.	Linked if same DICOM Frame of Reference, unlinked if different DICOM Frame of Reference	L (for “link”) and U (for “unlink”)	Pressing this button shall toggle the synchronization of the currently selected viewports from participating in synchronization of navigation, scrolling and zooming and panning.	See Section 4.16.4.2.2.6.5 Shall be grayed out if no series are available to link.
Window - Center/Width or Clamped Mode		IEC 60878-2003 5435 icon on the left with a Bohr atom symbol on the right with a solid line underneath	On for NM and PET images. Off for modalities other than NM and PET	No default shortcut	Pressing this button shall change the mode of windowing behavior for the selected viewport(s) between changing the window center and width, or adjustment of the upper value of the window with the lower limit clamped to zero.	See Section 4.16.4.2.2.6.4. The cursor displayed during windowing shall change to match the selected mode.
Annotation		Lines of text in four corners	Full annotation	I (for “information”)	Selecting this tool shall cycle through the activation states of posting text in the corners of each viewport containing annotations of demographics, management, location, timing and technique.	There are at least three states of no annotations, full annotations, and an intermediate state with less than full annotation. See Section 4.16.4.2.2.6.8.




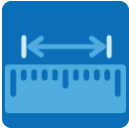
Tool	Icon Symbol	Icon Ref. or Desc.	Default State	Key	Action	Comments
Print		Drawing of a printer	Not applicable	P (for “print”)	Pressing this button shall cause the currently selected viewports (one or more), to be printed using the operating system printer, with the current windowed appearance, scroll position, zoom and pan state and annotation state (including both the corner annotations and any measurement tools that have been applied).	This is intended for printing reference images on consumer grade printers through the ordinary operating system printer drivers, not DICOM printers, and not for producing diagnostic quality prints.
Display Reset		IEC 60878-2003 5495 “Return to an initial state”	Not applicable	Escape	Pressing this button shall reset the selected viewports to their default zoom and pan state (fit image to viewport), without any rotation or flip, the window values to the initial default and will remove any measurements that have been made.	The scroll position shall not change when this button is pressed.
Show Report		Lines of text in two paragraphs	Not displayed.	R (for “report”)	Pressing this button shall cause all the reports available for the current patient to be displayed.	See 4.16.4.2.2.6.12. Shall be grayed out if no next reports available.



Tool	Icon Symbol	Icon Ref. or Desc.	Default State	Key	Action	Comments
Rotate 90 degrees clockwise		IEC 60878-2003 5772 "Rotation", modified to be single direction	Not rotated	No default shortcut	Pressing this button shall rotate the displayed image 90 degrees clockwise.	See Section 4.16.4.2.2.6.2 Successive button presses will rotate a further 90 degrees. Shall be grayed out if not applicable to type of image.
Flip Horizontally		IEC 60878-2003 5408 "Reversal right-to-left"	Not flipped	No default shortcut	Pressing this button shall flip the displayed image horizontally, i.e., about the vertical display axis.	See Section 4.16.4.2.2.6.2 A second button presses will flip the image back to its previous state. Shall be grayed out if not applicable to type of image.
Cine Tools		IEC 60878-2003 1123 "Cine radiographic exposure"	Not available	C (for "cine")	Pressing this button will make available the cine controls.	Shall be grayed out if FrameSet contains only one frame. Other navigation tools shall be grayed out when in cine mode.
Window Presets		IEC 60878-2003 5435 icon with a dropdown decoration	Defaults to first setting encoded in the image, or auto if none.	No default shortcut	Pressing this button shall present a drop down of window presets, which when the user makes a choice, shall apply to all selected viewports	Amongst the defaults shall be a choice for whatever settings are encoded in the image (which may be multiple), and a default computed from the properties of the pixels ("auto"). Additionally, for CT, presets for soft tissue, bone, lung and brain shall be provided at minimum. Shall be grayed out for color images.

Tool	Icon Symbol	Icon Ref. or Desc.	Default State	Key	Action	Comments
Help		IEC 60878-2003 5289 “Application assistance”	Not applicable	F1 or H (“help”)	Pressing this button shall provide access to a manual describing the use of the Image Display.	The form and encoding of the manual need not be the same as that required for the PDF manual on PDI media described in RAD TF-1:15.6.4.
Advanced Mode		Mortarboard	Basic mode	F10 (“menu”)	Pressing this button shall change to a different user interface providing advanced functionality	Shall be grayed out or absent if there is no different user interface providing advanced functionality. The advanced mode shall permit a return to the basic user interface.

**Table 4.16.4.2.2.6.13-2: Modal Tool Icons Appearance and Action**




Tool	Icon Symbol	Icon Ref. or Desc.	Default State	Key	Action	Comments
Zoom		Magnifying glass	Off	Z (for “zoom”)	Selecting this tool shall change the function of the left (or only) mouse button when held during mouse movement to change the magnification factor.	See Section 4.16.4.2.2.6.6
Pan		Open hand	Off	T (for “translate”)	Selecting this tool shall change the function of the left (or only) mouse button when held during mouse movement to cause the image to move with	See Section 4.16.4.2.2.6.6




					respect to the viewport.	
Window		IEC 60878-2003 5435 “Brightness/ Contrast”	Off	W (for “window”)	Selecting this tool shall change the function of the left (or only) mouse button when held during mouse movement to adjust the windowing parameters.	See Section 4.16.4.2.2.6.4. Shall be grayed out for color images.
Scroll		Stack of boxes (representing frames)	On	S (for “scroll”)	Selecting this tool shall change the function of the left (or only) mouse button when held during mouse movement to cause the frame displayed in the viewport to be scrolled to an earlier or later frame.	See Section 4.16.4.2.2.6.5
Select Viewport		Arrow facing upwards and to the left	Off	V (for “viewport”)	Pressing this button shall cause the viewport in which the cursor is placed when the left mouse button is next clicked to become the selected viewport to which subsequent operations shall apply.	Multiple viewports may be selected - see Section 4.16.4.2.2.6.11
Distance Measurement		Based on IEC 60878-2003 5658 “Distance Measurement”	Off	D (for “distance”)	Selecting this tool shall change the function of the left (or only) mouse button when clicked to begin a linear distance measurement at the location of the cursor and	See Section 4.16.4.2.2.6.10

					when clicked again to end it.	
Angle Measurement		Acute angle with the opening spanned by an arc with arrows at both ends	Off	A (for “angle”)	Selecting this tool shall change the function of the left (or only) mouse button when clicked to begin a distance measurement at the location of the cursor and when clicked again to define the end of the first segment, clicked again to begin a second segment and when clicked again to end it.	See Section 4.16.4.2.2.6.10.
Cross-hair tool		Crossed perpendicular dashed lines in a circle	Off	J	Selecting this tool shall change the function of the left (or only) mouse button when clicked to cause cross-hairs to be displayed.	See Section 4.16.4.2.2.6.7 Shall be grayed out if no series are displayed on which to show cross-hairs.

6970

**Table 4.16.4.2.2.6.13-3: Cine Tool Icons Appearance and Action**

Tool	Icon Symbol	Icon Ref. or Desc.	Default State	Key	Action	Comments
Cine Play		IEC 60878-2003 5107B “Normal run”	On	No default shortcut	Pressing this button shall play forwards at a normal rate.	
Cine Stop			Off	No default shortcut	Pressing this button shall stop cine and return to display of the first frame.	
Cine Pause			Off	No default shortcut	Pressing this button shall pause cine at the currently displayed frame.	

Tool	Icon Symbol	Icon Ref. or Desc.	Default State	Key	Action	Comments
Cine Go to Start			Off	No default shortcut	Pressing this button shall go to the first frame and pause.	
Cine Step		IEC 60878-2003 5471 "Frame by frame, general"	Off	No default shortcut	Pressing this button shall step one frame forwards.	
Cine Go to End			Off	No default shortcut	Pressing this button shall go to the last frame and pause.	

#### 4.16.4.2.3 Expected Actions

The Image Display or Imaging Document Consumer presents to the user a DICOM Image.

6975 The Image Display or Imaging Document Consumer may receive patient data inconsistent with those received from a previously issued query or retrieve operation. For example, in the event that a patient has been renamed, the Image Display or Imaging Document Consumer will receive images with the same Study Instance UID, Series Instance UID and SOP Instance UIDs, but with a different patient name. The Image Display or Imaging Document Consumer shall use the just queried information or the most recently received instances to ensure that the most recent patient data from the Image Manger/Archive or Imaging Document Source is displayed. In the case of 6980 the Image Display encoded on PDI Media by a Portable Media Creator which supports the Basic Viewer Option, the Patient information on the media shall be used.

The Image Display or Imaging Document Consumer shall be able to display the Series Description for each series displayed.

#### 6985 4.16.4.2.3.1 NM Image Specifics

Actors claiming the NM Image Profile which have applications that accept re-sliced (reconstructed tomographic) cardiac data for viewing or further processing shall make use of the View Code Sequence (0054,0220), Slice Progression Direction (0054,0500), and Acquisition Context Sequence (0040,0555) attributes to aid in the selection of input data. However, the 6990 means by which these attributes are used to identify and/or process the data is unspecified.

Note: a means for identifying and processing cardiac input data that does not include the above-mentioned attributes will likely be useful due to the existence of Images without those attributes. Series Description may be useful in such cases.

6995 Matching related studies or series (such as stress and rest images) is an important part of NM processing and display. When Image Displays are trying to do this, they shall look for the Patient

State (0038,0500) to identify such things as stress and rest images and in the NM Acquisition Context Module, the Image Orientation in the Detector Sequence, and the View Code Sequence (0054,0220) to identify images with desired orientations. Since images may exist without those fields present, the Series Description may also be examined for relevant details by the software.

7000



## 4.17 Retrieve Presentation States [RAD-17]

### 4.17.1 Scope

7005 This section describes the sequence of messages required for the Image Display or Imaging Document Consumer to retrieve Grayscale Softcopy Presentation State Instances from the Image Archive or Imaging Document Source. The Image Display or Imaging Document Consumer will query and then retrieve Presentation State objects. The transformations will be applied by the Image Display or Imaging Document Consumer to the image data to assure the image display is consistent with the device that originally created and stored the Presentation State. The Image  
7010 Display or Imaging Document Consumer will be required to support all transformations defined in DICOM [PS3.3: A.33.1](#) Grayscale Softcopy Presentation State IOD. In addition, multiple Presentation States may exist that reference the same image data.

### 4.17.2 Actor Roles

**Actor:** Image Display

7015 **Role:** Retrieve Grayscale Softcopy Presentation State objects together with the referenced image data and apply the transformations specified by the Presentation State. This device will implement the Query/Retrieve SOP Classes in the role of an SCU.

**Actor:** Imaging Document Consumer

7020 **Role:** Retrieve Grayscale Softcopy Presentation State objects together with the referenced image data and apply the transformations specified by the Presentation State. This actor must support pixel rendering according to the Grayscale Standard Display Function (GSDF) defined in DICOM [PS3.14](#). This device will implement the Query/Retrieve SOP Classes in the role of an SCU.

**Actor:** Image Archive

7025 **Role:** Respond to retrieve requests from the Image Display for Grayscale Softcopy Presentation States objects. Transmit requested Grayscale Softcopy Presentation State object(s) to the Image Display. This device will implement the Query/Retrieve SOP Classes in the role of an SCP.

**Actor:** Imaging Document Source

7030 **Role:** Respond to retrieve requests from the Imaging Document Consumer for Grayscale Softcopy Presentation States objects. Transmit requested Grayscale Softcopy Presentation State object(s) to the Imaging Document Consumer. This device will implement the Query/Retrieve SOP Classes in the role of an SCP.

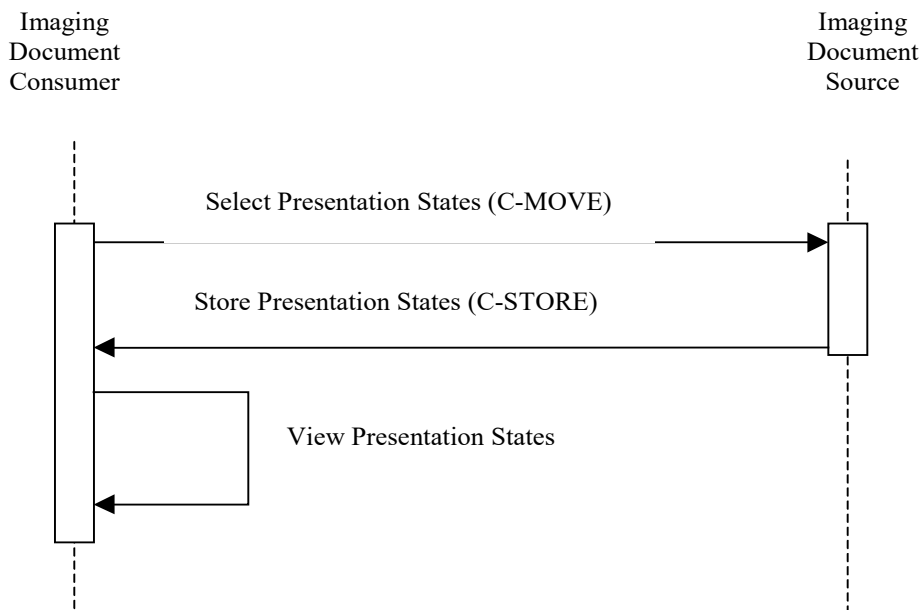
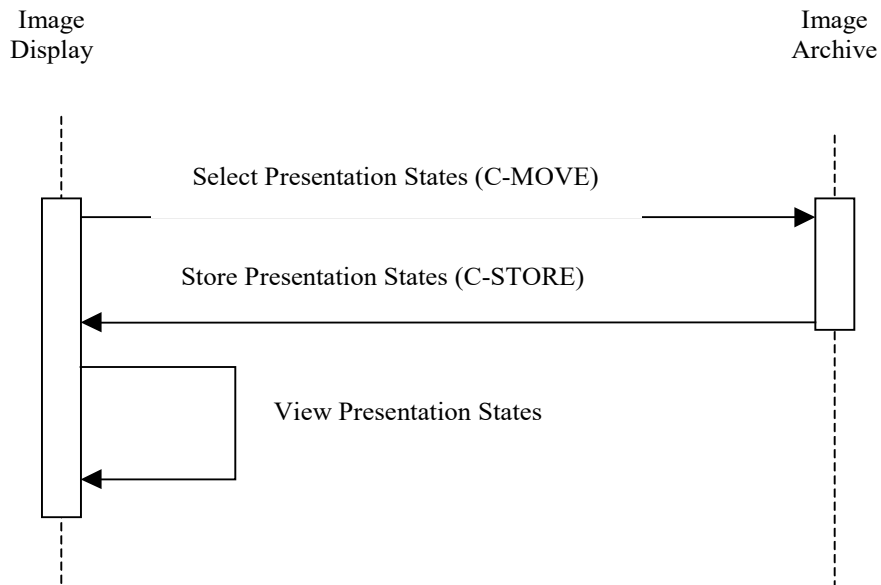
### 4.17.3 Referenced Standards

DICOM [PS3.4 Annex C](#): Query/Retrieve Service Class

7035 DICOM [PS3.14](#): Grayscale Standard Display Function

DICOM [PS3.3 A.33.1](#): Grayscale Softcopy Presentation State IOD

### 4.17.4 Messages



7040

**Figure 4.17.4-1: Interaction Diagrams**

#### 4.17.4.1 Retrieve Grayscale Softcopy Presentation State

This transaction refers to the “C-MOVE” and “C-STORE” messages between the Image Display and Image Archive or Imaging Document Consumer and Imaging Document Source in the above

7045 interaction diagram. The Retrieve (Study Root – MOVE and optionally Patient Root – MOVE) SOP Classes are supported. Refer to the DICOM PS3.4 for detailed descriptive semantics.

In the case of retrieving Grayscale Softcopy Presentation State in a Cross-Enterprise, imaging document sharing (XDS-I) network environment, a configuration of mapping the AE Titles to DICOM AE Network Addresses (IP Address and Port number) are needed to be exchanged  
7050 between the Imaging Document Source and the Imaging Document Consumer. RAD TF-2x: Appendix G describes in detail the AE Title mapping to the DICOM AE Network Addresses.

#### **4.17.4.1.1 Trigger Events**

The Image Display or Imaging Document Consumer selects specific Grayscale Softcopy Presentation State objects to retrieve from the Image Archive.

#### **7055 4.17.4.1.2 Message Semantics**

The message semantics are defined in the DICOM Query/Retrieve Service Class section of the DICOM PS3.4: Query/Retrieve Service Class. It is the responsibility of the Image Manager or Imaging Document Source to assure that the patient and procedure information is current in the images and Softcopy Presentation State objects when they are retrieved from the Image Archive  
7060 or Imaging Document Source.

#### **4.17.4.1.3 Expected Actions**

The Image Archive or Imaging Document Source receives the C-MOVE request, establishes a DICOM association with the Image Display or Imaging Document Consumer, respectively, and uses the DICOM Grayscale Softcopy Presentation State Storage SOP Class to transfer the requested Presentation State objects.  
7065

#### **4.17.4.2 View Presentation States**

This transaction relates to the “View Presentation States” event in the above interaction diagram. Presentation States cannot be viewed separately, but must be applied to an image. Refer to Section 4.16 for a description of the transaction used to retrieve images to which Presentation States may be applied.  
7070

#### **4.17.4.2.1 Trigger Events**

The Image Display or Imaging Document Consumer receives Presentation State instances from the Image Archive or Imaging Document Source respectively.

#### **4.17.4.2.2 Invocation Semantics**

7075 This is a local invocation of functions resident within the Image Display or Imaging Document Consumer. The method used by the Image Display or Imaging Document Consumer to present images for viewing by the user after the Presentation State transformations have been applied is outside the scope of the IHE Technical Framework.

#### **4.17.4.2.3 Expected Actions**

- 7080 The Image Display or Imaging Document Consumer applies the transferred Grayscale Softcopy Presentation State to image data and renders it for viewing. The Image Display shall support pixel rendering according to the Grayscale Standard Display Function (GSDF) defined in DICOM [PS3.14](#). The Image Display or Imaging Document Consumer may receive patient data inconsistent with those received from a previously issued query or retrieve operation. For
- 7085 example, in the event that a patient has been renamed, the Image Display or Imaging Document Consumer will receive Softcopy Presentation State objects with the same Study Instance UID, Series Instance UID and SOP Instance UIDs, but with a different patient name. The Image Display or Imaging Document Consumer shall use the just queried information or the most recently received instances to ensure that the most recent patient data from the Image
- 7090 Manger/Archive or Imaging Document Source is displayed. If the number of frames (0028,0008) attribute is set to 1, then the Reference Frame Number (0008,1160) shall be ignored.

## 4.18 Creator Images Stored [RAD-18]

### 7095 4.18.1 Scope

In the Creator Images Stored transaction, the Evidence Creator sends the newly generated images for a study to the Image Archive.

### 4.18.2 Actor Roles

**Actor:** Evidence Creator

7100 **Role:** Transmit generated image data to Image Archive.

**Actor:** Image Archive

**Role:** Accept and store images from Evidence Creators.

### 4.18.3 Referenced Standards

DICOM [PS3.4 Annex B](#): Storage Service Class.

### 7105 4.18.4 Messages



**Figure 4.18.4-1: Interaction Diagram**

### 4.18.4.1 Images Stored

#### 4.18.4.1.1 Trigger Events

7110 The Evidence Creator transfers images to the Image Archive sequentially within one or more DICOM associations, as the images become available or collectively.

Details about when it is appropriate to trigger the creation of a new Study/Series/Image Instance are described in Section 4.8.4.1.1.1 “Study UIDs and Series UIDs”.

#### **4.18.4.1.2 Message Semantics**

7115 The Evidence Creator uses the DICOM C-STORE message to transfer the images. The Evidence Creator is the DICOM Storage SCU and the Image Archive is the DICOM Storage SCP.

Per the DICOM Standard, the Evidence Creator shall create a new series for its created images and not extend series containing source images.

7120 The Evidence Creator derives images from source images, and the derived images may or may not have the same Image SOP Class as the source images.

7125 The source images may include Performed Procedure Step relationship information. This information will include Scheduled Procedure Step information for the procedure performed at an Acquisition Modality. When present in the source images, the Evidence Creator shall extract appropriate Scheduled Procedure Step information and include it with PPS information produced by the Evidence Creator.

See RAD TF-2x: Appendix A for rules on how to use the source image information in the derived image objects.

##### **4.18.4.1.2.1 Storage of Localizer Images (MR and CT)**

7130 In addition to these general mapping requirements, in MR and CT images, the relationship between localizer or plan images and axial images shall be recorded when such a relationship exists. In such a case the attribute Referenced Image Sequence (0008,1140) of the axial image shall refer to the related localizer or plan image(s). The coordinate space for the set of related images shall be the same, which is indicated by having a single value for the attribute Frame of Reference UID (0020,0052). For CT images the axial images shall have the value AXIAL in the attribute Image Type, and the localizer image the value LOCALIZER. For MR images no specific value for image type is used to further qualify the relationship between plan and axial images. If the Evidence Creator wants to show the location of the axial images on the localizer or plan image, a Presentation State object may be created for this purpose.

##### **4.18.4.1.2.2 Storage of NM Images (NM)**

7140 Systems supporting the NM Image Profile must support the requirements described in the Modality Images Stored transaction [RAD-8], Section 4.8.4.1.2.2 “Storage of NM Images and Section 4.8.4.1.2.2.1 NM Image IOD: Multi-Frames & Vectors”.

7145 An Image Creator that processes cardiac tomographic images (Image Type RECON TOMO or RECON GATED TOMO) and creates new cardiac tomographic images shall copy the Acquisition Context Sequence (0040,0555) and its contents into the created images.

##### **4.18.4.1.2.3 Storage of Cardiac Images (NM)**

7150 Evidence Creators, Acquisition Modalities or Image Displays creating reconstructed tomographic datasets shall incorporate Image Orientation [Patient] (0020,0037) (inside the Detector Information Sequence (0054,0022)), Image Position (0020,0032), and Spacing Between Slices (0018,0088).

7155 The standard cardiac views for reoriented RECON TOMO data are listed in Table 4.8-2. Evidence Creators creating a reconstructed tomographic dataset representing these standard cardiac views shall include the View Code Sequence (0054,0220), and Acquisition Context Sequence (0040,0555) attributes. Slice Progression Direction (0054,0500) shall be included for short axis images. These values are used for determination of later display and formatting in the ACC NM Cardiac Display.

7160 These requirements and the possible values for these DICOM fields are more completely explained in Section 4.8.4.1.2.2 Storage of NM Images (NM), Table 4.8-2 and associated notes following the table. If preferred window level settings based on activity within myocardial contours are known at the time of creation of cardiac short axis images, the information may be stored in Window Width (0028,1051) and Window Center (0028,1050).

#### **4.18.4.1.2.4 Result Screen Export Option**

7165 Evidence Creators claiming support of the Result Screen Export Option shall be capable of storing Result Screens as described in this section.

Result Screens refer to a presentation of result elements on the display, potentially including graphics, images and text, typically found on clinical analysis software such as NM cardiac packages.

7170 This option is intended to provide a way of exporting snapshots of Result Screens as DICOM objects so they can be viewed elsewhere on generic DICOM display systems. As things like DICOM SR Templates for various clinical results become available, such coded data formats provide a more robust solution and should be used in preference to the Result Screen Export Option. This Option is not intended to be used for transferring the clinical data for processing or database purposes.

7175 This option will refer to result screens which include moving images or graphics, such as a beating heart or rotating image, as Dynamic Result Screens. Result screens which do not include moving components will be referred to as Static Result Screens.

7180 Result screens which are completely presented in shades of grey will be referred to as Greyscale Result Screens. Result screens which use color presentation will be referred to as Color Result Screens. Result screens which present images in greyscale and only use small amounts of color for the graphics may optionally be considered Greyscale Result Screens.

7185 The Evidence Creator shall be capable of storing result screens it presents as described in this section. Note that if an Evidence Creator does not present Dynamic Result Screens, it is not required to implement the dynamic features described, and if an Evidence Creator does not present Color Result Screens, it is not required to implement the color features described.

The Evidence Creator shall use DICOM Secondary Capture (SC) IODs or Multi-Frame Secondary Capture (MFSC) IODs for storing Static Result Screens (see DICOM [PS3.3 Section A.8](#) Secondary Capture Image IOD). The use of MFSC IODs is preferred over the use of simple

- 7190 SC IODs due to the lack of attributes to indicate the content of the image, derivation and source of inputs, and other ambiguities in the SC IODs.
- Static Result Screens may be stored using the DICOM SC Image and a set of Static Result Screens may be stored one at a time in DICOM SC Images, however it is strongly recommended that the DICOM MFSC Image IODs be used both for sets of Static Result Screens and individual Static Result Screens.
- 7195 When multiple Static Result Screens are stored in a DICOM MFSC object, the Cine module shall not be included. The order of the Static frames in the MFSC shall represent the intended display order of the result screens.
- The Evidence Creator shall use DICOM MFSC IODs for storing Dynamic Result Screens. The cine module shall be included as described in Table 4.18-1. The frames shall be ordered to present a cine of the Dynamic Result Screen. The number of frames is not specified here. If there are several cine regions in the result screen and the length of their cine “cycle” is not the same, it is acceptable if there is a “jump” in the playback when the MFSC cycle loops back to the beginning.
- 7200
- 7205 The Evidence Creator shall support export of Color Result Screens as 24-bit RGB. Dynamic Color Result Screens shall be stored using Multi-frame True Color Secondary Capture Image Storage.
- The system shall also support export of result screens as 8-bit grayscale. It will sometimes be useful to export a given result screen in both color and greyscale formats. Evidence Creators that only present grayscale results are not required to export them as 24-bit RGB.
- 7210 Multiple SC and/or MFSC objects may be created in the same series to collect result screens which are associated by processing run as long as doing so doesn’t violate the Series rules outlined in RAD TF-1x: Appendix E.4.1 Study UIDs and Series UIDs.
- The image Instance Numbers shall be set/incremented to reflect the intended display order. Each time processing is repeated to create new Result Screens, it shall generate a new series.
- 7215 Conversion Type (0008,0064) in the SC Equipment module shall have a value of “WSD” (indicating images generated by a Workstation).
- Series Description (0008,103E) in the General Series module shall include an indication that these are result screens.
- 7220 Derivation Description (0008,2111) shall contain a description of the nature of the results and/or the processing that generated them.
- Modality (0008,0060) shall reflect the modality of the data used to generate the Result Screens. To ensure maximum compatibility with a variety of display systems, the Frame Time, Recommended Display Frame rate, and Cine Rate attributes in the Cine Module shall all be set to reflect the same frame rate.
- 7225 These values reflect the display rate of the stored result cine. It is not necessary to set the value to reflect “real world values” such as the actual patient heart rate.



**Table 4.18-1: Required Attributes for Multiframe Secondary Capture Cine Module**

Attribute	Tag	Type	Attribute Description
Preferred Playback Sequencing	(0018,1244)	R+	Describes the preferred playback sequencing for a multi-frame image. Shall have a value of 0 (which indicates Looping (1,2,..n,1,2,..n) )
Cine Rate	(0018,0040)	R+	Number of frames per second at which the Evidence Creator intends the results to be presented.
Frame Time	(0018,1063)	R	Nominal time (in msec) per individual frame. Equals 1000/CineRate
Recommended Display Frame Rate	(0008,2144)	R+	Same as Cine Rate

#### 4.18.4.1.2.5 Storage of DBT Reconstructions

7230 Evidence Creators that support the Digital Breast Tomosynthesis (DBT) Profile shall support all of the attribute requirements in Section 4.8.4.1.2.7 for Acquisition Modalities supporting the Breast Tomosynthesis Image Storage SOP Class.

Evidence Creators shall store derived tomosynthesis reconstructions (e.g., slabs) using the Breast Tomosynthesis Image Storage SOP Class.

#### 4.18.4.1.2.6 Enterprise Identity Option

7235 An Evidence Creator supporting the Enterprise Identity Option shall include values for the following Patient Context-critical attributes in the generated SOP instances that are copied from the corresponding source attribute in the originating SOP instance, if available:

**Table 4.18-2: Enterprise Identity Option – Patient context-critical attributes**

Patient Context-critical Attributes	Tag
Issuer of Patient ID	(0010,0021)
Issuer of Patient ID Qualifiers Sequence	(0010,0024)
>Universal Entity ID	(0040,0032)
>Universal Entity ID Type	(0040,0033)
Other Patient IDs Sequence	(0010,1002)
>Patient ID	(0010,0020)
>Issuer of Patient ID	(0010,0021)
>Issuer of Patient ID Qualifiers Sequence	(0010,0024)
>>Universal Entity ID	(0040,0032)
>>Universal Entity ID Type	(0040,0033)
>Type of Patient ID	(0010,0022)

7240 In the case where Issuer of Patient ID and Issuer of Patient ID Qualifiers Sequence attributes are not explicitly supplied in the SOP Instances received, the Evidence Creator shall not include values for these attributes in the generated SOP Instances sent.

Note: this requirement is intended to reduce complexity of information reconciliation on the Image Manager and Order Filler. An implementation that supports configuration of default values for these attributes will need to be configured, so that these defaults contain no value.

7245

An Evidence Creator supporting the Enterprise Identity Option shall include values for the following Accession Context-critical attributes in the generated SOP instances that are copied from the corresponding source attribute in the originating SOP instance, if available:

**Table 4.18-3: Enterprise Identity Option – Accession context-critical attributes**

Accession Context-critical Attributes	Tag
Issuer of Accession Number Sequence	(0008,0051)
>Local Namespace Entity ID	(0040,0031)
>Universal Entity ID	(0040,0032)
>Universal Entity ID Type	(0040,0033)

7250

An Evidence Creator shall send values for the following Institution Context-critical attributes in the generated SOP Instances describing where the SOP Instances were created:

**Table 4.18-4: Enterprise Identity Option – Institution context-critical attributes**

Institution Context-critical Attributes	Tag
Institution Name	(0008,0080)
Institution Address	(0008,0081)
Institution Code Sequence	(0008,0082)
>Code Value	(0008,0100)
>Coding Scheme Designator	(0008,0102)
>Code Meaning	(0008,0104)

7255 These institution values shall be configurable as part of the Evidence Creator’s default setup parameters. Note that the original images may not be acquired at the same institution where the evidence documents are created.

For mobile devices which create Evidence Documents at multiple locations, there may be multiple default values, one for each institution the device is used.

#### 4.18.4.1.2.7 Intentionally Left Blank

#### 7260 4.18.4.1.3 Expected Actions

The Image Archive will store the received DICOM objects.

The DICOM objects shall be stored such that they can be later retrieved (see Section 4.16 Retrieve Images) in a fashion meeting the requirements defined for a DICOM Level 2 Storage SCP (refer to DICOM [PS3.4 Section B.4.1](#)).

7265 **4.18.4.1.3.1 DICOM Image Storage SOP Classes**

Image Archives that support the NM Image Profile are required to support all of the SOP classes listed in Table 4.8-5. Evidence Creators that support the NM Image Profile are required to support at least one of the SOP classes listed in Table 4.8-5.

7270 Evidence Creators shall be capable of providing all created Nuclear Medicine image types using the Nuclear Medicine Image SOP class.

Image Archives and Evidence Creators that support the Digital Breast Tomosynthesis (DBT) Profile are required to support the Breast Tomosynthesis Image Storage SOP Class.

7275 Evidence Creators that support the Result Screen Export Option are required to support all the SOP classes listed in Table 4.18-5 that are dictated by the Evidence Creators result presentation capabilities, as described in Section 4.18.4.1.2.4.

**Table 4.18-5: Result Screen Export SOP Classes**

SOP Class UID	SOP Class Name
1.2.840.10008.5.1.4.1.1.7	Secondary Capture Image Storage
1.2.840.10008.5.1.4.1.1.7.2	Multi-frame Grayscale Byte Secondary Capture Image Storage
1.2.840.10008.5.1.4.1.1.7.4	Multi-frame True Color Secondary Capture Image Storage

**4.18.4.1.3.2 Enterprise Identity Option**

An Image Manager supporting the Enterprise Identity Option shall support the requirements from Section 4.8.4.1.3.2 Enterprise Identity Option.

7280

## 4.19 Creator Presentation State Stored [RAD-19]

### 4.19.1 Scope

7285 This section describes DICOM Grayscale Softcopy Presentation States Storage requests issued by the Evidence Creator to the Image Archive. The Evidence Creator sends Presentation States for storage along with the images so they could be later used for support of consistent display of imaging data. The Evidence Creator is the DICOM Store SCU and the Image Archive is the DICOM Store SCP. DICOM [PS3.3: A.33.1](#) Grayscale Softcopy Presentation State IOD defines the transformations supported by this transaction.

### 4.19.2 Actor Roles

7290 **Actor:** Evidence Creator

**Role:** Generate Grayscale Softcopy Presentation States to be applied to image data. This actor will support the ability to send Presentation State data to an Image Archive.

**Actor:** Image Archive

7295 **Role:** Accept and store Grayscale Softcopy Presentation State Instances received from the Evidence Creator. This transaction describes the role related only to storage of the Presentation State information.

### 4.19.3 Referenced Standards

DICOM [PS3.4 Annex B](#): Storage Service Class

DICOM [PS3.4 Annex N](#): Softcopy Presentation State Storage SOP Classes

7300 DICOM [PS3.14](#): Grayscale Standard Display Function

### 4.19.4 Messages



**Figure 4.19.4-1: Interaction Diagram**

#### **4.19.4.1 Creator Presentation State Stored**

##### **7305 4.19.4.1.1 Trigger Events**

The Evidence Creator generates a Grayscale Softcopy Presentation State Instance and sends it to the Image Archive for storage.

##### **4.19.4.1.2 Message Semantics**

7310 The Evidence Creator uses the DICOM C-STORE message to store Grayscale Softcopy Presentation States. All grayscale processing operations, and all spatial and graphical operations, that are relevant to the resulting presentation of the referenced image have to be recorded in the presentation state. This will preserve the "as-last-seen" view of the image, with for example the contrast setting, rotation, flip and text annotation. The image operations in the presentation state override whatever is recorded in the image itself, even in the case that no attributes for a specific  
7315 operation (e.g., Window Width/Window Level operation) are present in the presentation state. The latter case by definition specifies an identity operation. The full message semantics are defined in the Grayscale Softcopy Presentation State Storage SOP Class behavior section of DICOM PS3.4.

7320 The Evidence Creator derives images and Grayscale Softcopy Presentation State objects from source images that may include Modality Performed Procedure Step relationship information. This information will include Scheduled Procedure Step information for the procedure performed at an Acquisition Modality. When present in the source images, the Evidence Creator shall extract appropriate Scheduled Procedure Step information and include it with PPS information produced by the Evidence Creator.

7325 Grayscale Softcopy Presentation States that reference multi-frame images shall populate the Referenced Frame Number (0008,1160) in each applicable occurrence of the Referenced Image Sequence (0008,1140) in the Grayscale Softcopy Presentation State, unless the presentation state applies to all the frames in the image.

##### **4.19.4.1.3 Expected Actions**

7330 The Image Archive will store the received Grayscale Softcopy Presentation State objects.

## 4.20 Creator Procedure Step In Progress [RAD-20]

### 4.20.1 Scope

7335 This Performed Procedure Step of the Evidence Creator will be appended to the Modality  
Performed Procedure Steps done at the Acquisition Modality for the same Scheduled Procedure  
Step. It includes a message from the Evidence Creator to the Performed Procedure Step  
Manager, which in turn issues the messages to the Department System Scheduler/Order Filler  
and the Image Manager. The Performed Procedure Step Manager must support forwarding  
7340 messages to two different destinations. It shall start issuing messages to the configured  
destinations immediately after it accepts the corresponding messages from the Evidence Creator.  
For the details on the Performed Procedure Step Manager refer to Section 4.6.1.

### 4.20.2 Actor Roles

**Actor:** Department System Scheduler/Order Filler

**Role:** Receives the PPS information forwarded by the Performed Procedure Step Manager

7345 **Actor:** Image Manager

**Role:** Receives the PPS information forwarded by the Performed Procedure Step Manager

**Actor:** Evidence Creator

**Role:** Informs the Performed Procedure Step Manager that a particular Performed Procedure  
Step has started

7350 **Actor:** Performed Procedure Step Manager

**Role:** Accepts Performed Procedure Step information from an Evidence Creator and transmits it  
to the Department System Scheduler/Order Filler and Image Manager

### 4.20.3 Referenced Standards

DICOM [PS3.4 Annex F](#): Modality Performed Procedure Step SOP Class.

7355

## 4.20.4 Messages

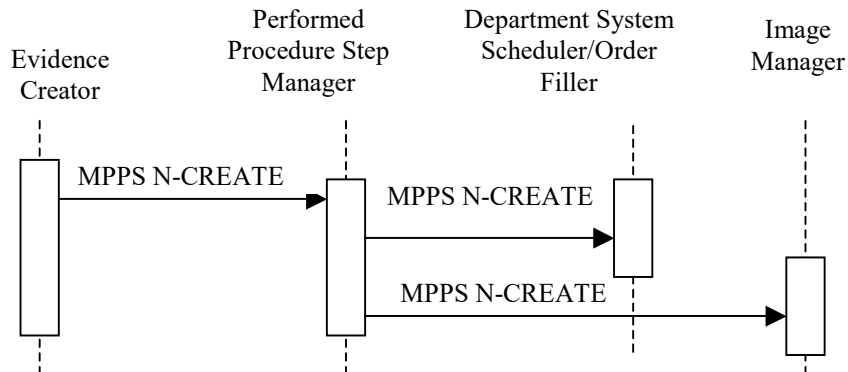


Figure 4.20.4-1: Interaction Diagram

### 4.20.4.1 Procedure Step Started Message

#### 7360 4.20.4.1.1 Trigger Event

Technologist begins with the generation of DICOM objects such as images, Key Image Notes or Presentation States at the Evidence Creator station.

#### 4.20.4.1.2 Message Semantics

7365 The Evidence Creator uses the Modality Performed Procedure Step SOP Class (N-CREATE Service) to inform the Performed Procedure Step Manager that a specific image generation Procedure Step has been started and is in progress. In turn, the Performed Procedure Step Manager uses the N-CREATE Service to forward the information to the Department System Scheduler/Order Filler and Image Manager. The SOP Instance UID value of the Performed Procedure Step shall be conveyed in the Affected SOP Instance UID (0000,1000) during this interchange (see also corresponding notes in RAD TF-2x: Appendix A.1). The following aspects shall be taken into the account during implementation of this step.

7370

##### 4.20.4.1.2.1 Patient/Procedure/Procedure Step Information

7375 The Evidence Creator shall ensure that the Patient/Procedure/Procedure Step information it has is valid and current. In this case a Modality Worklist does not provide the identification and relationship information, but the Evidence Creator extracts the Scheduled Procedure Step information from the images it uses as originals. If those images satisfied several Scheduled Procedure Steps, information about all of them may be recorded in the resulting PPS messages and image headers.

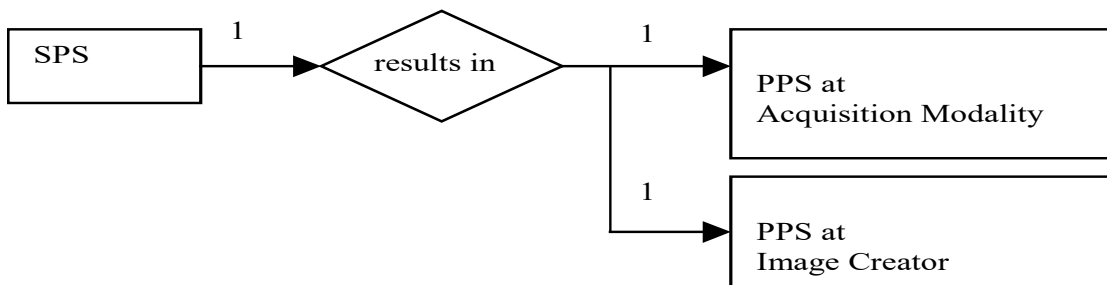
##### 4.20.4.1.2.2 Required Attributes

7380 RAD TF-2x: Appendix A lists a number of attributes that have to be properly handled by the Evidence Creator to ensure consistency between Performed Procedure Step object attributes and information included into the generated images.

**4.20.4.1.2.3 Relationship between Scheduled and Performed Procedure Steps**

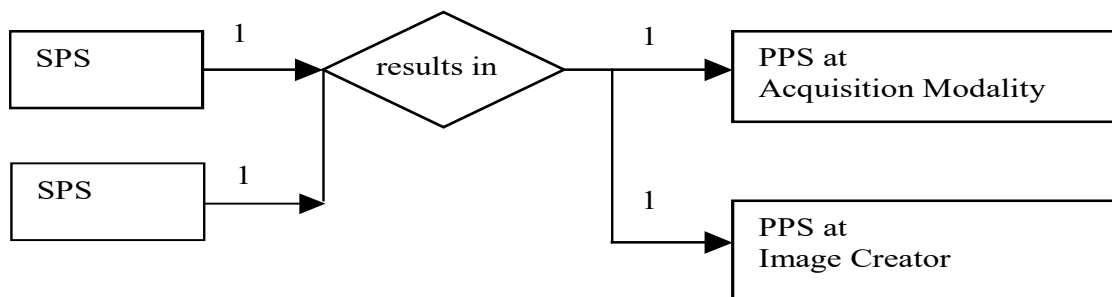
7385 In this case the Scheduled Procedure Step is specified in the relationship part of the MPPS information in the source images. Therefore, we have the Append Case relationship between Scheduled and Performed Steps. Refer to RAD TF-2x: Appendix A for details of forming attributes (Study Instance UID, Procedure ID, Accession Number, etc.) in this case.

**4.20.4.1.2.3.1 Append Case**



**Figure 4.20.4.1.2.3.1-1: Append to a Normal Case**

7395 This is a special case of 1-to-N relationship between SPS and PPS where the first PPS is generated at the Acquisition Modality in response to an SPS. The new Performed Procedure Step is added at the Evidence Creator at a later time. The Performed Procedure Step will refer back to the same Requested Procedure and to the original SPS. All Requested Procedure and Scheduled Procedure Step attributes contained in the source images shall be copied to the Performed Procedure Step Relationship Module and the image Request Attribute Sequence (see RAD TF-2x: Appendix A).



**Figure 4.20.4.1.2.3.1-2: Append to a Group Case**



7405 When the first PPS generated at the Acquisition Modality results from a Group Case (see Section 4.6.4.1.2.3.4 or 4.6.4.1.2.3.6), the Performed Procedure Step appended by the Evidence Creator may refer back to any one or more of the original SPSs and related Requested Procedure(s) which were grouped, using information from the Request Attribute Sequence in the original images. The corresponding attributes shall be copied from the images to the Performed Procedure Step Relationship Module and the image Request Attribute Sequence (see RAD TF-2x: Appendix A).

7410 Note: For example, following a PPS performed on an MR Modality in response to the grouping of a "neck" SPS and a "head" SPS, a 3D analysis on the MR head images is performed on the Image Display/Creator. This Display/Creator application may choose to link the appended PPS associated with the 3D secondary captures images resulting from the 3D analysis with both the head and the neck SPSs.

**4.20.4.1.2.4 Enterprise Identity Option**

7415 An Evidence Creator supporting the Enterprise Identity Option shall send values for the following Patient Context-critical attributes as specified in RAD TF-2x: Appendix A to ensure consistency between Performed Procedure Step object attributes, Scheduled Procedure Step information, and the information included in MPPS objects that are copied from the corresponding source attribute in the originating SOP Instance, if available:

**Table 4.20-1: Enterprise Identity Option – Patient context-critical attributes**

Patient Context-critical Attributes	Tag
Issuer of Patient ID	(0010,0021)
Issuer of Patient ID Qualifiers Sequence	(0010,0024)
>Universal Entity ID	(0040,0032)
>Universal Entity ID Type	(0040,0033)
Other Patient ID Sequence	(0010, 1002)
>Patient ID	(0010,0020)
>Issuer of Patient ID	(0010,0021)
>Issuer of Patient ID Qualifiers Sequence	(0010,0024)
>>Universal Entity ID	(0040,0032)
>>Universal Entity ID Type	(0040,0033)

7420

An Evidence Creator shall send values for the following Accession Context-critical attributes as specified in RAD TF-2x: Appendix A to ensure consistency between the Performed Procedure Step object attributes, Scheduled Procedure Step information from the originating SOP Instances, and the information included in the generated MPPS objects, if available:

7425 **Table 4.20-2: Accession Identity Option – Patient context-critical attributes**

Accession Context-critical Attributes	Tag
Issuer of Accession Number Sequence	(0008,0051)
>Local Namespace Entity ID	(0040,0031)

Accession Context-critical Attributes	Tag
>Universal Entity ID	(0040,0032)
>Universal Entity ID Type	(0040,0033)

#### 4.20.4.1.3 Expected Actions

The DSS/Order filler receives information from the Performed Procedure Step Manager and links it with the Requested Procedure. If the Requested Procedure ID is transmitted empty, the Department System Scheduler/Order Filler and the Image Manager will create an exception that must be manually resolved to link the Performed Procedure Step to the appropriate procedure.

7430

## 4.21 Creator Procedure Step Completed [RAD-21]

### 4.21.1 Scope

7435 This transaction includes a message from the Evidence Creator to the Performed Procedure Step Manager, which in turn issues the messages to the DSS/Order Filler and the Image Manager that the Performed Procedure Step has been completed. Information is not being released for billing at this point but a code may be assigned. The Image Manager may need the information to co-locate SOP instances of the same study. The Performed Procedure Step Completed message does not necessarily mean that the set of images is complete or available for retrieval.

7440

### 4.21.2 Actor Roles

**Actor:** Departmental System Scheduler/Order Filler

**Role:** Receives the PPS information forwarded by the Performed Procedure Step Manager

**Actor:** Image Manager

7445 **Role:** Receives the PPS information forwarded by the Performed Procedure Step Manager

**Actor:** Evidence Creator

**Role:** Informs the Performed Procedure Step Manager that a particular Performed Procedure Step is completed

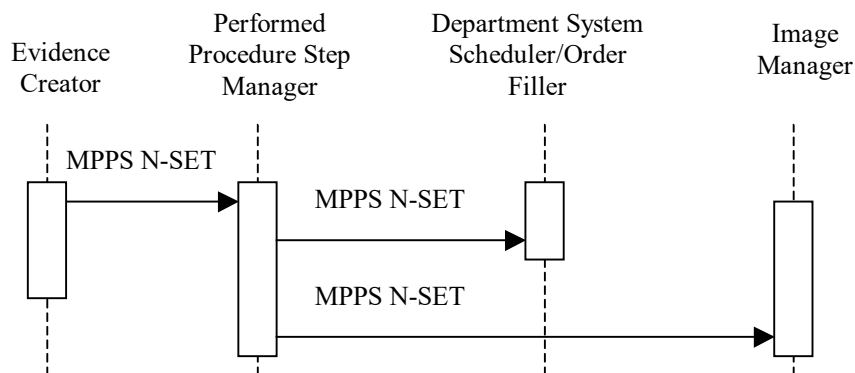
**Actor:** Performed Procedure Step Manager

7450 **Role:** Accepts Performed Procedure Step information from an Evidence Creator and transmits it to the Department System Scheduler/Order Filler and the Image Manager

### 4.21.3 Referenced Standards

DICOM [PS3.4 Annex F](#): Modality Performed Procedure Step SOP Class.

### 4.21.4 Messages



7455

**Figure 4.21.4-1: Interaction Diagram**

Note: The diagram above shows the sequencing of messages for the Performed Procedure Step SOP Class. Evidence Creators will also implement the Storage and Storage Commitment classes. The timing relationship between MPPS messages and Storage and Storage Commitment messages is not specified. That is, MPPS messages may occur before or after storage requests.

7460

#### **4.21.4.1 Procedure Step Completed/Discontinued**

##### **4.21.4.1.1 Trigger Event**

Technologist completes the procedure step from the Evidence Creator station.

##### **4.21.4.1.2 Message Semantics**

7465

The Evidence Creator uses the Modality Performed Procedure Step SOP Class (N-SET Service) to inform the Performed Procedure Step Manager that a specific Procedure Step has been completed or discontinued. For further details on the message semantics refer to Section 4.7.4.1.2.

7470

The Evidence Creator derives images and Grayscale Softcopy Presentation State objects from source images that include Performed Procedure Step information. This information will include scheduled step information for the procedure performed at an Acquisition Modality. When present in the source images, the Evidence Creator shall extract appropriate PPS information and include it with the PPS messages and the images produced by the Evidence Creator.

7475

Note: DICOM specifies that when attributes are allowed to be set by an N-SET, the value provided by the last N-SET overrides any value set by an earlier N-CREATE or N-SET.

##### **4.21.4.1.2.1 PPS Exception Management Option**

When an Evidence Creator supports the PPS Exception Management Option, it shall provide the appropriate reason codes (often selected by the operator) in the final N-SET sent with the status of DISCONTINUED.

7480

When the Modality Procedure Step is sent with the Status DISCONTINUED, the Modality Procedure Step Discontinuation Reason Code Sequence (0040,0281) shall be sent with one of the values defined DICOM [PS3.16 Annex B CID 9301](#) Modality PPS Discontinuation Reasons.

The Reason Code when communicated to the DSS/Order Filler and Image Manager/Archive may imply canceling an order. It may also facilitate more accurate charge posting.

7485

## **4.22 Intentionally Left Blank**

This transaction was defined in earlier versions of the Radiology Technical Framework. It is now combined with Storage Commitment in transaction [RAD-10].

7490

## 4.23 Print Request with Presentation LUT [RAD-23]

### 4.23.1 Scope

7495 This transaction supports the capability of the Print Composer to ensure display consistency for images rendered by the Print Server. The Print Composer sends a DICOM Print Request to the Print Server. The request includes the specification of a Presentation Look Up Table (LUT) to be applied to the image data at the Film Box level. The Print Composer will be the DICOM Print SCU and the Print Server will be the DICOM Print SCP.

### 4.23.2 Actor Roles

7500 **Actor:** Print Composer

**Role:** Generate DICOM Print Requests as a DICOM Print SCU. Systems which include display capability must support pixel rendering according to the DICOM Grayscale Standard Display Function (GSDF) as defined in DICOM [PS3.14](#). The Print Requests must specify and reference Presentation LUTs to be applied by the SCP to the image data to maintain desired image perception.

7505

**Actor:** Print Server

**Role:** Process DICOM Print Requests as a DICOM Print SCP. The system must support pixel rendering according to the DICOM Grayscale Standard Display Function (GSDF) as defined in DICOM [PS3.14](#) and be able to transform the image data using the specified Presentation LUT to produce the desired image perception.

7510

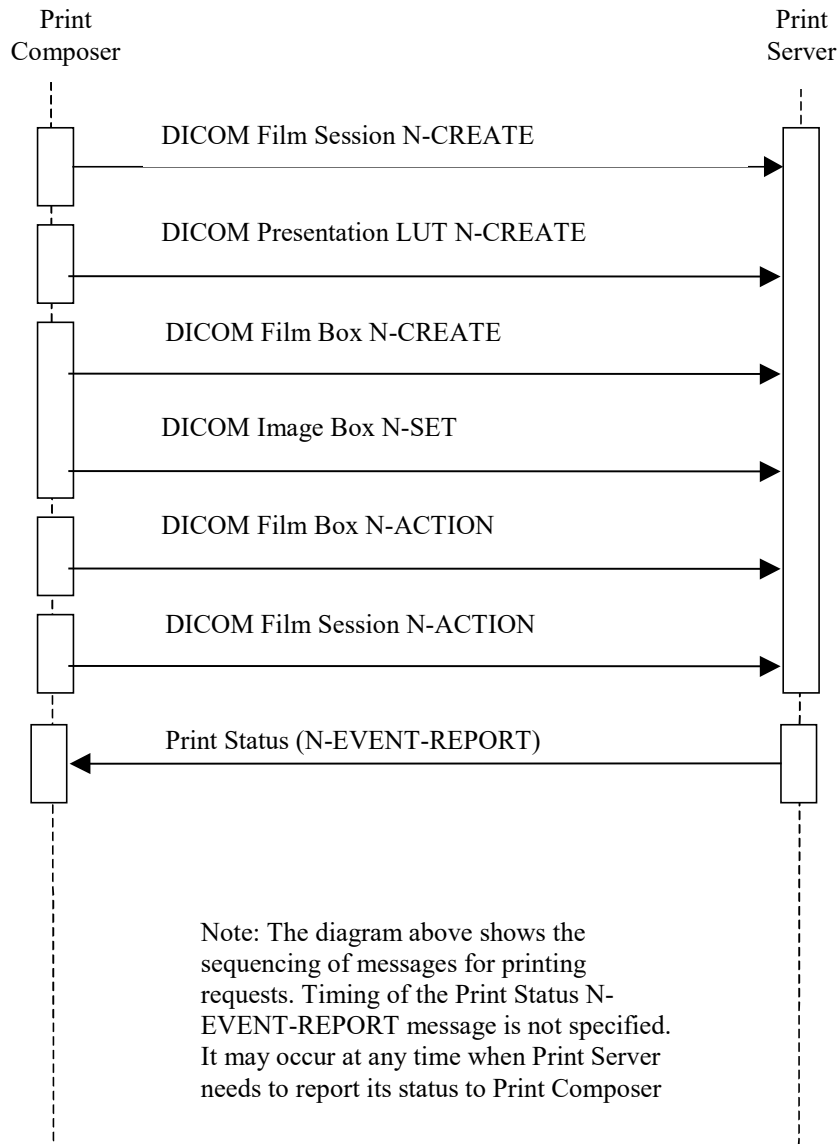
### 4.23.3 Referenced Standards

DICOM [PS3.4 Annex H](#): Print Management Service Class

DICOM [PS3.4 Section H.4.9](#): Presentation LUT SOP Class

DICOM [PS3.14](#): Grayscale Standard Display Function

7515 **4.23.4 Messages**



**Figure 4.23.4-1: Interaction Diagram**

7520 **4.23.4.1 DICOM Film Session N-CREATE**

Support of this message is required for the Print Composer and Print Server in the IHE Technical Framework. The Film Session N-CREATE message describes the presentation parameters

common to all sheets of film in a film session. Implementation of this message will be according to the DICOM Basic Print Management Meta SOP Class.

7525 **4.23.4.1.1 Trigger Events**

The Print Composer initiates a Print Request to the Print Server.

**4.23.4.1.2 Message Semantics**

The DICOM Print Management Service Class Behavior defines the message semantics for the Basic Film Session SOP Class.

7530 **4.23.4.1.3 Expected Actions**

The Print Server shall create the Film Session SOP Instance and initialize attributes as specified in the N-CREATE. The Print Server shall return the status code of the requested SOP Instance creation as defined for the Basic Film Session SOP Class.

**4.23.4.2 DICOM Presentation LUT N-CREATE**

7535 The Presentation LUT data specified by this N-CREATE will be used to transform the image data at the film box level to realize specific image display characteristics suitable to the Print Composer. In addition, this message can use the Presentation LUT Shape Attribute to specify a pre-defined Presentation LUT Shape (The Presentation LUT Shape value of “LIN OD” will not be supported for the IHE Radiology Technical Framework, except for the Mammography Image Profile (see Section 4.23.4.8). Presentation LUT information will only be specified and applied at the Film Box level.

Note: In the event a Print Composer chooses to specify a Presentation LUT Shape of IDENTITY instead of a Presentation LUT then the image data will be sent to the Print Server in the form of P-values for interpretation by the Print Server according to the GSDF.

7545 Note: Print composers are encouraged to refer to DICOM [PS3.14 Annex B](#) for calibration measurements requirements. Where these data are not available or when it is uncertain on which viewbox the film will be viewed, Print Composers may use the suggested default values specified in DICOM PS3.14 for the attributes of Illumination (2010,015E) and Reflected Ambient Light (2010,0160) for conventional images (for Mammography Image Requirements, see Section 4.23.4.8). For transmissive hardcopy printers the standard recommends 2000 cd/m<sup>2</sup> for Illumination and 10 cd/m<sup>2</sup> for reflected ambient light. For reflective hardcopy printers the standard recommends 150 cd/m<sup>2</sup> for Illumination (maximum luminance obtainable from diffuse reflection of the illumination present.) These values are also consistent with those used in the illustrative examples in DICOM [PS3.14 Annex D](#).

7550

**4.23.4.2.1 Trigger Events**

7555 This message will be triggered when the Print Composer receives a successful status response from the Print Server following transmission of the Film Session N-CREATE message.

**4.23.4.2.2 Message Semantics**

7560 The DICOM Print Management Service Class Behavior defines the message semantics for the Presentation LUT SOP Class. Presentation LUTs supplied by the Print Composer will be required to have a number of entries corresponding to the bit depth of the image data (e.g., 256 entries for 8 bit image data, 4096 entries for 12 bit image data).



**4.23.4.2.3 Expected Actions**

The Print Server shall create a Presentation LUT SOP Instance and initialize attributes as specified in the N-CREATE. The Print Server shall return the status code of the requested SOP Instance creation as defined for the Presentation LUT SOP Class.

7565 **4.23.4.2.4 User Specifiable Lighting Condition Option**

When a Print Composer supports the User Specifiable Lighting Condition Option, it shall provide the means to override the default values for the attributes of Illumination (2010,015E) and Reflected Ambient Light (2010,0160).

7570 The suggested default values specified in DICOM PS3.14 for the attributes of Illumination (2010,015E) and Reflected Ambient Light (2010,0160) are clinical practice guidelines for average viewing conditions which are sufficient in cases where the clinical user does not know on which light box the film will be viewed (see also the Consistent Presentation of Images whitepaper by Marco Eichelberg, et. al. entitled Consistency of Softcopy and Hardcopy: Preliminary Experiences with the new DICOM Extensions for Image Display, Proceedings of SPIE 2000.).

7575

**4.23.4.3 DICOM Film Box N-CREATE**

Per the DICOM standard support of this message is required by the Print Composer and Print Server in the IHE Radiology Technical Framework. The Film Box N-CREATE message describes the presentation parameters common to a single sheet of film in a film session.

7580 **4.23.4.3.1 Trigger Events**

This message will be triggered when the Print Composer receives a successful status response from the Print Server following transmission of the Presentation LUT N-CREATE message.

**4.23.4.3.2 Message Semantics**

7585 The DICOM Print Management Service Class Behavior defines the message semantics for the Basic Film Box SOP Class. A Film Box N-CREATE will be issued for each sheet of film in a multi-film session. The Print Composer, behaving as a DICOM Print SCU, may use default values for Illumination (2010,015E), Reflective Ambient Light (2010,0160), Min Density (2010,0120), and Max Density (2010,0130) as specified in DICOM PS3.14. In addition, the Film Box N-CREATE message will reference Presentation LUT SOP instances created by the

7590 Presentation LUT N-CREATE message. Table 4.23-1 below specifies the Basic Film Box Attribute values required to be supported by the SCU.

**Table 4.23-1: Film Box Module Attributes Supported by the Print Composer**

Tag	Attribute Name	Supported Values
(2010,0010)	Image Display Format	STANDARD\C, R (C = columns, R = rows)

Tag	Attribute Name	Supported Values
(2010,0040)	Film Orientation	PORTRAIT LANDSCAPE
(2010,0050)	Film Size ID	8INX10IN 11INX14IN 14INX17IN
(2010,0060)	Magnification Type	REPLICATE BILINEAR CUBIC NONE

#### 4.23.4.3.3 Expected Actions

7595 The Print Server shall create the Film Box SOP Instance and initialize attributes as specified in the N-CREATE. The Print Server will create an Image Box SOP Instance for each image box defined by the Image Display Format attribute (2010,0010) at the time the Basic Film Box SOP Instance is created. The Print Server shall return the status code of the requested SOP Instance creation as defined for the Basic Film Box SOP Class. Additional behavior is defined in the description of the Basic Film Box SOP Class for the DICOM Print Management Service Class  
7600 within the DICOM Standard.

#### 4.23.4.4 DICOM Image Box N-SET

7605 Per the DICOM standard support of this message is required by Print Composer and Print Server in the IHE Technical Framework. The Image Box N-SET message describes the presentation parameters and image pixel data specific to a single image box on a single sheet of film within a film session.

##### 4.23.4.4.1 Trigger Events

This message will be triggered when the Print Composer receives a successful status response from the Print Server following transmission of the Film Box N-CREATE message.

##### 4.23.4.4.2 Message Semantics

7610 The DICOM Print Management Service Class Behavior defines the message semantics for the Image Box SOP Classes. An Image Box N-SET will be issued for each Image Box defined by the Display Format attribute (2010,0010) of the Film Box N-CREATE message.

##### 4.23.4.4.3 Expected Actions

7615 The Print Server will apply the specified image box attributes to the Image Box SOP Instance. The Print Server shall return the status code of the requested SOP Instance update as defined for the Image Box SOP Class.

#### **4.23.4.5 DICOM Film Box N-ACTION**

7620 Support of this message is required by the Print Composer and Print Server in the IHE Technical Framework. The Film Box N-ACTION message is used to print a single sheet of film in the film session.

##### **4.23.4.5.1 Trigger Events**

This message will be triggered when the Print Composer receives a successful status response from the Print Server following transmission of the last Image Box N-SET message for the specified Film Box.

##### **7625 4.23.4.5.2 Message Semantics**

The DICOM Print Management Service Class Behavior defines the message semantics for the Film Box SOP Classes.

##### **4.23.4.5.3 Expected Actions**

7630 The Print Server prints the sheet of film described by the film box. Presentation LUT SOP Instances referenced at the Film Box or Image Box levels will be applied to the image data. The Print Server shall return the appropriate status code as defined for the Film Box N-ACTION DIMSE Service of the DICOM Print Management Service Class.

#### **4.23.4.6 DICOM Film Session N-ACTION**

7635 Support of this message is optional by the Print Composer and Print Server in the IHE Technical Framework. The Film Session N-ACTION message is used to print all sheets of film in the film session.

##### **4.23.4.6.1 Trigger Events**

7640 This message will be triggered when the Print Composer receives a successful status response from the Print Server following transmission of the last Image Box N-SET message for the specified Film Session.

##### **4.23.4.6.2 Message Semantics**

The DICOM Print Management Service Class Behavior defines the message semantics for the Film Session SOP Classes.

##### **4.23.4.6.3 Expected Actions**

7645 The Print Server prints the film session. Presentation LUT SOP Instances referenced at the Film Box or Image Box levels will be applied to the image data. The Print Server shall return the appropriate status code as defined for the Film Session N-ACTION Service of the DICOM Print Management Service Class.

#### **4.23.4.7 Print Status (N-EVENT-REPORT)**

7650 Per the DICOM standard, support of this message is required by the Print Composer and Print Server in the IHE Radiology Technical Framework. The N-EVENT-REPORT is used to report Print Server status to the Print Composer in an asynchronous manner. That is, a print SCP may send an N-EVENT-REPORT message while the SCU is transmitting additional print commands. The SCU and SCP are required to accommodate these asynchronous messages.

##### **4.23.4.7.1 Trigger Events**

This message will be triggered when the Print Server senses a change in the status related to the Print Request that is worthy of notification to the Print Composer.

##### **4.23.4.7.2 Message Semantics**

7660 The DICOM Print Management Service Class Behavior defines the message semantics for the Printer SOP Class.

##### **4.23.4.7.3 Expected Actions**

The Print Composer will return the confirmation of the N-EVENT-REPORT operation to the Print Server.

#### **4.23.4.8 Mammography Image and Digital Breast Tomosynthesis Profile**

7665 Requirements specific to print are specified for mammography since there are regulatory requirements in many jurisdictions with respect to the need to provide the patient with images of primary diagnostic quality that are appropriately annotated.

Print Composers participating in the Mammography Image Profile or the Digital Breast Tomosynthesis Profile shall:

- 7670 • Be capable of true size printing of all the pixels of a single view per sheet of film based on the value stored in Imager Pixel Spacing (0018,1164) in the Mammography Image SOP Instances being printed, so that distance measurements made optically on the printed film will be approximately equivalent to those made on a film-screen mammography exposure, and shall use Requested Image Size (2020,0030) to command the Print Server to use the correct image size. Note that the Imager Pixel Spacing (0018, 1164) should not be corrected by Estimated Radiographic Magnification Factor (0018,1114), since doing so for magnified views would not only exceed the size of the available print area, but would deviate from the accepted film-screen practice.
- 7675
- 7680 • For Breast Tomosynthesis Image SOP Instances, be capable of true size printing of all the pixels of a selected frame per sheet of film based on the value stored in Pixel Spacing (0020,0030), and shall use Requested Image Size (2020,0030) to command the Print Server to use the correct image size. When printing selected frames of a magnified view, if printing the entire field of view, the Print Composer shall not send Requested Image Size (2020,0030).

- 7685
  - Be capable of justifying the images in the print request such that the chest wall will be printed as close to the edge of the film as the Print Server is capable.
  - Be capable of sending the Maximum Density attribute (2010,0130).
  - For Digital Mammography X-Ray Image SOP instances, be capable of burning into the pixel data sent to the Print Server all the annotations defined in the clinical set for Image Displays in Section 4.16.4.2.2.1.1.5.1 Annotation of Identification Information, and additionally Institution Address (0008,0081), Section 4.16.4.2.2.1.1.5.2 Annotation of Technical Factor Information, and Section 4.16.4.2.2.1.1.5.3 Annotation of View Information.
- 7690
- 7695
  - For Breast Tomosynthesis Image SOP instances, be capable of burning into the pixel data sent to the Print Server all the annotations defined in the clinical set for Image Displays in Section 4.16.4.2.2.1.3.5.1 Annotation of Identification Information and additionally Institution Address (0008,0081), Section 4.16.4.2.2.1.3.5.2 Annotation of Technical Factor Information and Section 4.16.4.2.2.1.3.5.3 Annotation of View Information.
- 7700
  - Be capable of burning a ruler, caliper or other form of distance scale into the pixel data sent to the Print Server
  - Be capable of transmitting a pixel data bit depth of 12 bits to the Print Server (i.e., an 8 bit path is not sufficient for mammography)
  - Be capable of burning into the pixel data sent to the Print Server a VOI LUT transformation (linear, sigmoid or tabular) as selected by the user from those available in the original image or as otherwise provided by the user
- 7705

Print Servers participating in the Mammography Image Profile or the Digital Breast Tomosynthesis Profile shall:

- Print on transmissive media
- 7710
  - Be capable of true size printing based on the Requested Image Size (2020,0030) and shall attain the requested size with a precision of a maximum 2% error in linear distance (this precision requirement is chosen based not any implied or required accuracy of measurements from film or projection radiography, but rather because current electrical, mechanical and optical technology readily allows for this precision, and deviation beyond this value indicates a fundamental flaw in the implementation of the protocol or logic)
- 7715
  - Be capable of printing with a border between the chest wall edge of the digital mammography image and the physical edge of the film no greater than 5mm, so that the printed films can be hung on a light box with the chest wall edges of corresponding views directly abutted.
- 7720
  - Be capable of applying the Maximum Density attribute (2010,0130) in the request, and printing with a maximum optical density no less than 3.5
  - Be capable of receiving a pixel data bit depth of 12 bits from the Print Composer (i.e., an 8 bit path is not sufficient for mammography).

- Be capable of using a Presentation LUT Shape value of “IDENTITY” and “LIN OD” and the Presentation LUT Sequence (2050,0010)

7725 Note that support for a Presentation LUT Shape value of “LIN OD” by Print Servers is specified for Mammography since the expected transmitted illumination of mammography view boxes on which printed film may be hung exceeds the range of illumination for which the Barten model is defined, and hence it may be difficult to achieve consistency between prints, and between prints and displays. It allows the Print Composer to use “LIN OD” to have greater control over the optical density of the printed film, and to take what action is necessary to result in consistency of appearance for the anticipated viewing conditions.

7730

## 4.24 Report Submission [RAD-24]

### 4.24.1 Scope

7735 In the Report Submission transaction, the Report Creator transmits a DICOM Structured Report (SR) object in an initial draft or final state to the Report Manager. The Structured Report object is required minimally to conform to the template TID 2000. Creators may introduce increased complexity as long as it conforms to the SOP class.

7740 A final report is defined as one where the Completion Flag (0040,A491) attribute is set to “COMPLETE” and the Verified Flag (0040,A493) attribute is set to “VERIFIED”. Reports with any other values for the Completion Flag (0040,A491) or the Verified Flag (0040,A493) attributes are considered draft reports.

### 4.24.2 Actor Roles

**Actor:** Report Creator

7745 **Role:** Transmit draft or final DICOM Structured Reports to Report Manager.

**Actor:** Report Manager

**Role:** Accept draft and final DICOM Structured Reports for management.

### 4.24.3 Referenced Standards

DICOM [PS3.4 Annex B](#): Storage Service Class

7750 DICOM [PS3.16](#): Content Mapping Resource

### 4.24.4 Messages

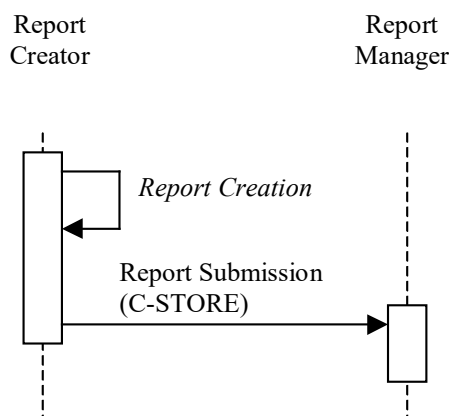


Figure 4.24.4-1: Interaction Diagram

#### 4.24.4.1 Report Creation

7755 This transaction relates to the “Report Creation” event in the above interaction diagram.

#### **4.24.4.1.1 Trigger Events**

The user at the Report Creator wishes to create a DICOM Structured Report.

#### **4.24.4.1.2 Invocation Semantics**

7760 This is a local invocation of functions at the Report Creator, and the method used by the Report  
Creator to obtain report data and create a DICOM Structured Report object is outside the scope  
of the IHE Technical Framework. The Report Creator shall create a report that conforms to the  
DICOM Basic Text SR Information Object Definition (IOD). If numeric values are required in  
7765 the report, then the Report Creator shall create a report that conforms to the DICOM Enhanced  
SR IOD. A single Report Creator may support both SR IODs if this is deemed desirable by the  
implementers, but must at least support the Basic Text SR IOD. Reports created by the Report  
Creator shall also conform to the DCMR template in DICOM [PS3.16 TID 2000](#).

##### **4.24.4.1.2.1 Coded Entries**

7770 All Reporting actors (Report Creator, Report Manager, Report Repository, and External Report  
Repository Access) must be able to load configurable code tables. The DICOM Structured  
Report objects are dependent on coded entries to define the concepts being conveyed. Codes  
specified in DCMR (DICOM PS3.16) shall be. In the absence of standard codes, the IHE  
Committee may define necessary codes for use in demonstrations.

7775 The types of reports created by the Report Creator are defined in RAD TF-1: 9.4. At a minimum,  
the Report Creator shall be able to generate reports based on the Simple Image Report (RAD TF-  
1: 9.4.1). If the Report Creator supports the Enhanced SR Information Object Definition then it  
shall also support the creation of Simple Image and Numeric Reports (RAD TF-1: 9.4.2).

##### **4.24.4.1.2.2 Retrieve AE Title**

7780 Whenever references to DICOM Composite objects are made within a DICOM Structured  
Report, it is possible to include the Retrieve AE Title attribute (0008,0054). In the case of the  
Report Creator, these references shall be contained in the Current Requested Procedure Evidence  
Sequence attribute (0040,A375), or the Pertinent Other Evidence Sequence attribute  
(0040,A385). If the Report Creator is a standalone actor it is optional for the Retrieve AE Title  
7785 attribute (0008,0054) to be sent and it is up to the implementation to determine what value to  
send. If the Report Creator is combined with an Image Display, then it is recommended that the  
Retrieve AE Title attribute (0008,0054) be set to the AE Title of the device from which the  
Image Display retrieved the referenced DICOM Composite objects.

##### **4.24.4.1.2.3 Study Identification and Identical Documents Sequence**

7790 A Study Instance UID is required to identify the study to which the report belongs. It is  
recommended to use the Study Instance UID of the images reported on as the Study Instance  
UID of the created Structured Report. The mechanism by which the Report Creator will receive  
this information is defined in the IHE Technical Framework. Sometimes a single report refers to  
multiple studies. For example, a trauma patient may require X-rays of both the wrist and leg.  
These may be ordered as separate studies, but the Radiologist may report on both studies at the



7795 same time. To handle this situation in the DICOM Hierarchical Model, it is necessary to  
duplicate the report within each study. If a Report Creator is generating a single report for  
multiple studies, it shall create multiple copies of the report, with different SOP Instance UIDs  
for each study and use the Identical Documents Sequence attribute (0040,A525) in each report.  
7800 The Identical Documents Sequence attribute (0040,A525) in each report shall reference each of  
the other identical reports in the other studies. The actual content of the report, that is, the SR  
Document General Module attributes (except the Identical Documents Sequence attribute) and  
the SR Document Content Module attributes shall be the same in each report instance.

The Retrieve AE Title attribute (0008,0054) in the Identical Documents Sequence Items shall not  
be sent.

#### **4.24.4.1.3 Expected Actions**

7805 Creation of DICOM Structured Report objects ready for storage to the Report Manager.

#### **4.24.4.2 Report Submission**

This transaction relates to the “DICOM C-STORE” event between the Report Creator and  
Report Manager in the above interaction diagram.

##### **4.24.4.2.1 Trigger Events**

7810 When report authoring is completed and the Report Creator creates new DICOM Structured  
Reports, the Report Creator shall transfer DICOM Structured Reports to the Report Manager  
within one or more DICOM associations.

##### **4.24.4.2.2 Message Semantics**

7815 The Report Creator uses the DICOM C-STORE message to transfer DICOM Structured Reports.  
The Report Creator is the DICOM Storage SCU of the Basic Text SR Storage SOP Class or the  
Enhanced SR Storage SOP Class or both. The Report Manager is the DICOM Storage SCP of at  
least the Basic Text SR Storage SOP Class and optionally the Enhanced SR Storage SOP Class.  
In accordance with the DICOM Standard for SR the Report Manager must support Level 2 (Full)  
storage, which means all DICOM Type 1, 2 and 3 attributes are stored.

##### **4.24.4.2.3 Expected Actions**

7820 The Report Manager will store the received DICOM Structured Report objects. At this point the  
Report Creator relinquishes any responsibility for the report objects and may not change them in  
any way without creating a new object with a new SOP Instance UID.

7825 **4.25 Report Issuing [RAD-25]**

**4.25.1 Scope**

7830 In the Report Issuing transaction, the Report Manager transmits either an unchanged draft DICOM Structured Report (created by a Report Creator) or a new modified DICOM Structured Report to the Report Repository or both. The Report Manager handles all state and content changes to DICOM Structured Reports, and with each change new DICOM Structured Report objects are created and may be stored in the Report Repository.

**4.25.2 Actor Roles**

**Actor:** Report Manager

7835 **Role:** Process report changes and transmit reports to Report Repository. This involves the ability to handle content and state changes to DICOM Structured Reports and create new DICOM Structured Reports based on these changes. Examples of the types of changes the Report Manager needs to process are as follows:

- Verifying a draft report and setting the verification attributes in the newly created verified report;
- 7840 • Creating a new unverified report based on one or more previous draft or verified reports;
- Creating a new verified report based on one or more previous draft or verified reports; and
- Creating a new report that is the result of merging multiple previous reports.
- 7845 • Generating a new version of an existing report with updated patient demographics based on receiving a Patient Update transaction.

**Actor:** Report Repository

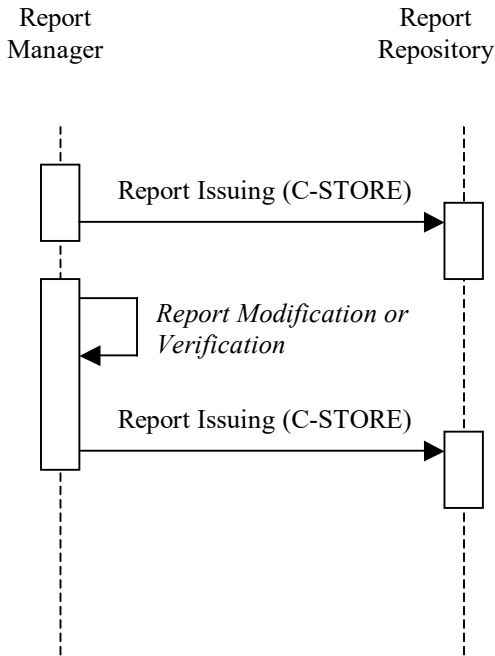
**Role:** Accept and store DICOM Structured Reports from Report Managers.

**4.25.3 Referenced Standards**

DICOM [PS3.4 Annex B](#): Storage Service Class

7850 DICOM [PS3.16](#): Content Mapping Resource

#### 4.25.4 Messages



**Figure 4.25.4-1: Interaction Diagram**

7855 **4.25.4.1 Report Issuing (Step 1)**

This transaction relates to the top “DICOM C-STORE” event between the Report Manager and Report Repository in the above interaction diagram.

**4.25.4.1.1 Trigger Events**

7860 When DICOM Structured Reports are received from the Report Creator, the Report Manager can transfer the DICOM Structured Reports to the Report Repository within one or more DICOM associations. This capability may be configurable as it may enable access to reports before they are verified and finalized. Some sites may require this feature, while others may find it undesirable.

**4.25.4.1.2 Message Semantics**

7865 The Report Manager uses the DICOM C-STORE message to transfer DICOM Structured Reports. The Report Manager is the DICOM Storage SCU of at least the Basic Text SR Storage SOP Class and optionally the Enhanced SR Storage SOP Class. It is required that if a Report Manager is an SCP of the Enhanced SR Storage SOP Class (see Section 4.24) then it shall also be an SCU of the Enhanced SR Storage SOP Class. The Report Repository is the DICOM Storage SCP of both the Basic Text SR Storage SOP Class and the Enhanced SR Storage SOP

7870

Class. In accordance with the DICOM Standard for SR, the Report Repository must support Level 2 (Full) storage, which means all DICOM Type 1, 2 and 3 attributes are stored.

#### **4.25.4.1.3 Expected Actions**

The Report Repository will store the received DICOM Structured Report objects.

#### 7875 **4.25.4.2 Report Modification**

This transaction relates to the “Report Modification or Verification” event in the above interaction diagram.

##### **4.25.4.2.1 Trigger Events**

7880 The user at the Report Manager selects an existing report and decides to make some modification to this report.

##### **4.25.4.2.2 Invocation Semantics**

7885 This is a local invocation of functions at the Report Manager, and the method used by the Report Manager to specify report state transitions or obtain modified report data and create a new DICOM Structured Report object is outside the scope of the IHE Technical Framework. The Report Manager shall create a report that conforms to the DICOM Basic Text SR Information Object Definition or the DICOM Enhanced SR Information Object Definition if numeric values are to be included in the report either by their addition by the Report Manager or numeric values appeared in the original report received from the Report Creator. It is required that if a Report Manager can receive Enhanced SR objects, that it can also manage such objects and generate new Enhanced SR objects. If the Report Manager removes numeric values from a report it may convert an Enhanced SR object into a Basic Text SR object. When the Report Manager creates a new modified report, it must be in a different series to the original report, unless the Report Manager and Report Creator are the same device. This is because the DICOM Standard requires that objects created by different devices must be in different series (i.e., different DICOM General Equipment Module attributes). In order to reference the original report, the new modified report must correctly contain the Predecessor Documents Sequence attribute (0040,A360).

7890 The types of external state changes that the Report Manager shall handle are:

- Completing a partial report; and
- Verifying a report.

7900 To complete a partial report, additional content may be added to the original report and the Completion Flag attribute (0040,A491) shall be set to “COMPLETE”. To verify a report, the content of the original report is checked for correctness, and the Verification Flag attribute (0040,A493) shall be set to “VERIFIED”. This also requires that the Verifying Observer Sequence attribute (0040,A073) be completed appropriately.

7910 The types of reports that at a minimum shall be handled by the Report Manager are defined in  
RAD TF-1: 9.4. The Report Manager shall be able to manipulate reports based on the Simple  
Image Report (RAD TF-1: 9.4.1). If the Report Manager supports the Enhanced SR Information  
Object Definition then it shall also support manipulation of Simple Image and Numeric Reports  
7915 (RAD TF-1: 9.4.2). Even though the IHE Technical Framework sets boundaries on the  
complexity of SR objects, the Report Manager must still be able to receive and store any Basic  
Text SR object and optionally any Enhanced SR object in order to conform to the DICOM  
Standard. An implementation may restrict the modification capabilities for reports more complex  
than those specified in RAD TF-1: 9.4. When creating a new report, the Report Manager shall  
also conform to the DCMR template in DICOM [PS3.16 TID 2000](#).

There are many reasons and methods for the Report Manager to modify the content of a report  
and these are outside the scope of the IHE Technical Framework. Examples of the types of  
changes, in addition to the state changes above, the Report Manager needs to be able to process  
are as follows:

- 7920 • Creating a new report based on one or more previous draft or verified reports where data  
is changed or added;
- Creating a new report that is the result of merging multiple previous reports. This can  
also involve changing or adding report data; and
- 7925 • Converting a Basic Text SR into an Enhanced SR if the Report Manager adds  
measurements. This also means that if a Basic Text SR is merged with an Enhanced SR  
then the resulting object will be an Enhanced SR.

It is recommended that amendments to DICOM Structured Reports are made by creating a new  
DICOM Structured Report object containing the original content as well as any amendments or  
additions. References to the original report are made by the Predecessor Document Sequence  
7930 attribute (0040,A360).

In general report issuing requires that a new SR instance UID will be created as a result of the  
rules defined by DICOM [PS3.4 Section O.3](#) - Modification of SR Document Content.

#### **4.25.4.2.2.1 Retrieve AE Title**

7935 Whenever references to DICOM Composite objects are made within a DICOM Structured  
Report, it is possible to include the Retrieve AE Title attribute (0008,0054). In the case of the  
Report Manager, these references will be contained in the Predecessor Documents Sequence  
attribute (0040,A360), as well as the Current Requested Procedure Evidence Sequence attribute  
(0040,A375) and the Pertinent Other Evidence Sequence attribute (0040,A385) if the Report  
Creator uses these evidence sequence attributes.

7940 The Report Creator may send reports to the Report Manager where the Retrieve AE Title  
attribute (0008,0054) in the Current Requested Procedure Evidence Sequence Items  
(0040,A375), or the Pertinent Other Evidence Sequence Items (0040,A385) is empty or not sent.  
In these cases, the Report Manager may add the AE Title of a configured Image Manager in the  
Retrieve AE Title attribute (0008,0054) of these sequence items.

7945 When the Report Manager creates a new report based on one or more previous reports that it has already stored in the Report Repository, then the AE Title of the Report Repository shall be used as the Retrieve AE Title attribute (0008,0054) in the Predecessor Documents Sequence Items (0040,A360). If the prior reports have not been stored in the Report Repository then the Retrieve AE Title attribute (0008,0054) shall not be sent.

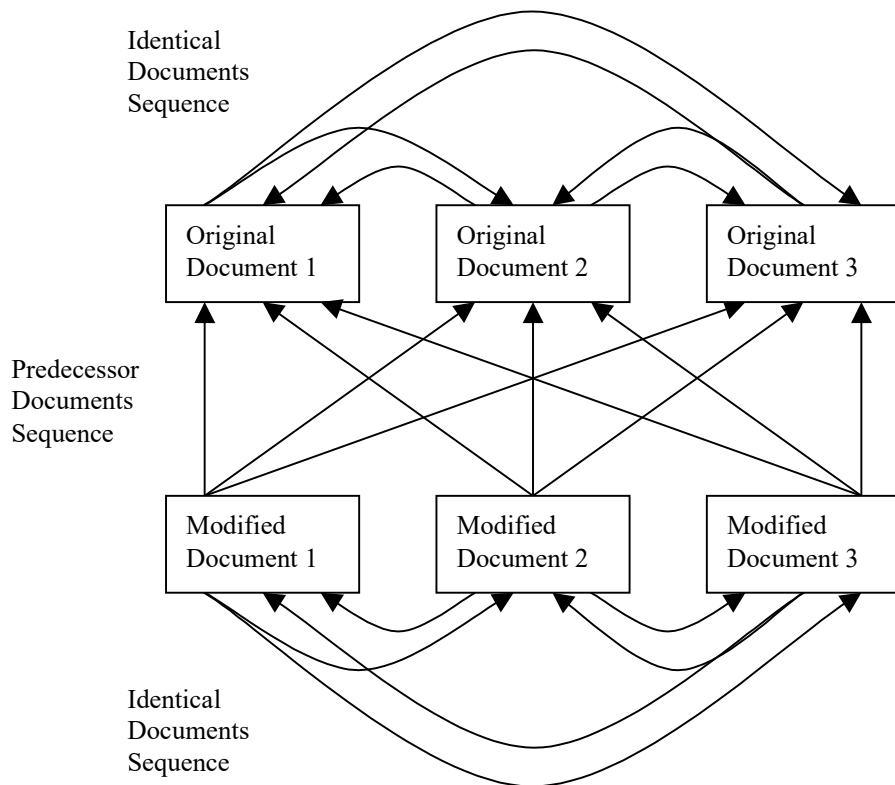
7950 **4.25.4.2.2.2 Study Identification and Identical Documents Sequence**

A Study Instance UID is required to identify the study to which the report belongs. It is recommended to use the Study Instance UID of the images reported on as the Study Instance UID of the created Structured Report. The mechanism by which the Report Creator will receive this information is currently undefined in the IHE Technical Framework. The expectation is that the DICOM General Purpose Worklist service will be used for this function when this service is finalized in DICOM and incorporated in the IHE Radiology Technical Framework.

7955 When the Report Manager is modifying a report that contains items in the Identical Documents Sequence attribute (0040,A525) then a decision is needed as to the actions to occur upon the other identical documents. The user modifying the report may be asked as to whether the changes may only apply to the current report or to the other identical documents as well. If the changes are limited to one report, then no Identical Documents Sequence attribute (0040,A525) shall be included in the new report as it is no longer the same as the other documents. If the changes are to apply to multiple reports, then multiple new reports with new SOP Instance UIDs shall be created with the new report data and their Identical Documents Sequence attribute (0040,A525) shall refer to the appropriate new report objects. Also in this case each Predecessor Documents Sequence attribute (0040,A360) shall refer to all the original identical documents. This is shown in Figure 4.25-1.

7960

7965



**Figure 4.25-1: Identical and Predecessor Document Sequences**

7970 **4.25.4.2.3 Expected Actions**

Creation of a new modified DICOM Structured Report object ready for storage to the Report Repository.

**4.25.4.3 Report Issuing (Step 2)**

7975 This transaction relates to the bottom “DICOM C-STORE” event between the Report Manager and Report Repository in the above interaction diagram.

**4.25.4.3.1 Trigger Events**

7980 When reports are finalized (complete and verified) they shall be stored in the Report Repository. The Report Manager can transfer DICOM Structured Reports to the Report Repository within one or more DICOM associations. Internal reports shall be temporarily stored in the Report Manager until they are finalized, but may also be stored permanently in the Report Repository if the Report Manager decides to transfer them. The technique used by the Report Manager to finalize a report is outside the scope of the IHE Technical Framework.

#### **4.25.4.3.2 Message Semantics**

7985 The Report Manager uses the DICOM C-STORE message to transfer DICOM Structured Reports. The Report Manager is the DICOM Storage SCU of at least the Basic Text SR Storage SOP Class and optionally the Enhanced SR Storage SOP Class. It is required that if a Report Manager is an SCP of the Enhanced SR Storage SOP Class (see Section 4.24) then it shall also be an SCU of the Enhanced SR Storage SOP Class. The Report Repository is the DICOM Storage SCP of both the Basic Text SR Storage SOP Class and the Enhanced SR Storage SOP Class. In accordance with the DICOM Standard for SR the Report Repository must support Level 2 (Full) storage, which means all DICOM Type 1, 2 and 3 attributes are stored.

7990

#### **4.25.4.3.3 Expected Actions**

The Report Repository will store the received DICOM Structured Report objects.

7995



## 4.26 Query Reports [RAD-26]

### 4.26.1 Scope

In the Query Reports Transaction, the Report Reader queries the Report Manager, Report Repository or External Report Repository Access for draft or final DICOM Structured Reports.

### 8000 4.26.2 Actor Roles

**Actor:** Report Repository

**Role:** Responds to queries for DICOM Structured Reports.

**Actor:** External Report Repository Access

8005 **Role:** Responds to queries for DICOM Structured Reports. This system provides storage of DICOM Structured Reports obtained from outside the Radiology department. Such a system may be required to convert reports of different formats (HL7) into DICOM Structured Reports (see RAD TF-2x: Appendix C).

**Actor:** Report Reader

8010 **Role:** Queries Report Repository or External Report Repository Access for DICOM Structured Reports and makes them available for selection.

**Actor:** Report Manager

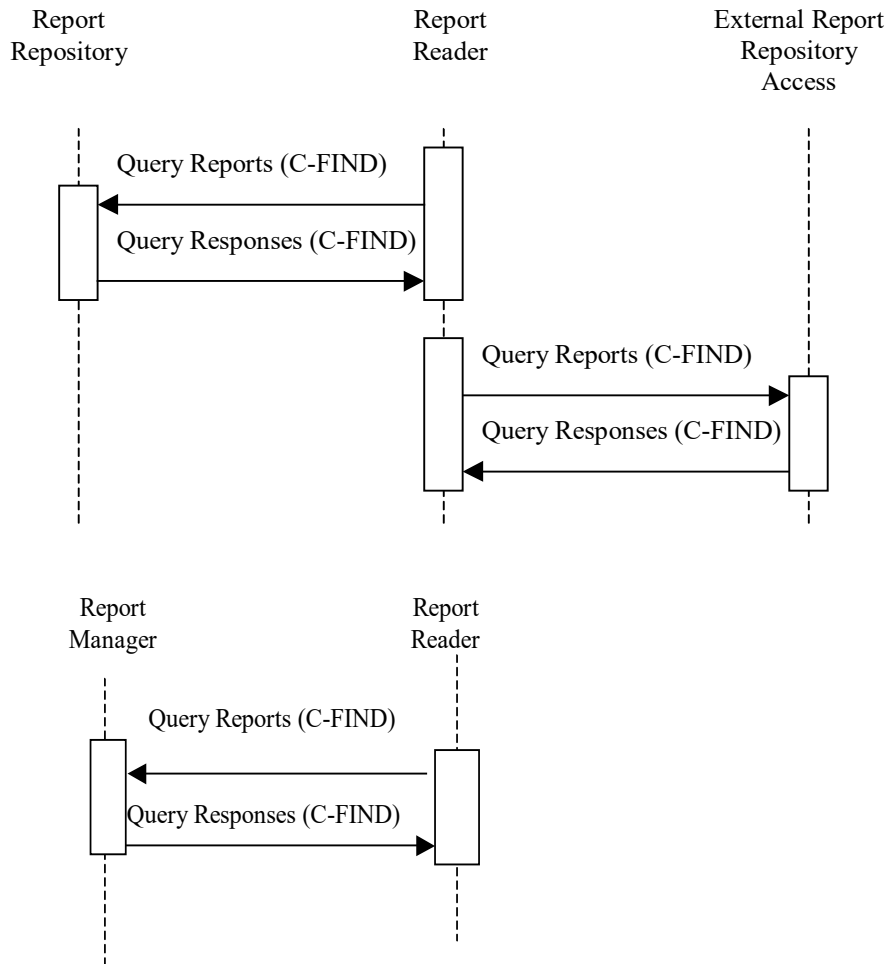
**Role:** Responds to queries for DICOM Structured Reports.

### 4.26.3 Referenced Standards

DICOM [PS3.4 Annex C](#): Query/Retrieve Service Class

8015 DICOM [PS3.16](#): Content Mapping Resource

### 4.26.4 Messages



**Figure 4.26.4-1: Interaction Diagram**

8020 **4.26.4.1 Query Reports**

This transaction relates to the query section of the above interaction diagram. The Query (Study Root – FIND and optionally Patient Root – FIND) SOP Classes will be supported. Refer to DICOM PS3.4: Query/Retrieve Service Class for detailed descriptive semantics.

**4.26.4.1.1 Trigger Events**

8025 The user at the Report Reader wishes to view selected reports.

**4.26.4.1.2 Message Semantics**

The message semantics are defined by the DICOM Query/Retrieve SOP Classes.

8030 A C-FIND Request from the DICOM Study Root Query/Retrieve Information Model – FIND SOP Class or the DICOM Patient Root Query/Retrieve Information Model – FIND SOP Class shall be sent from the Report Reader to the Report Manager, Report Repository or External Report Repository Access.

The Report Reader uses one or more matching keys as search criteria to obtain the list of matching entries in the Report Manager, Report Repository or External Report Repository Access at the selected level (Patient & Study/Series/Instance).

8035 In addition to the required and unique keys defined by the DICOM Standard, the IHE Technical Framework has defined matching and return keys to be supported by query SCUs and SCPs. The keys are defined in Section 4.14.4.1.2 and Table 4.14-1, except that Report Manager and Report Repository are not required to support PPS Start Date and PPS Start Time. The conventions for key usage are defined in Section 2.2. For the Report Reader (SCU) and the Report Manager, Report Repository and External Report Repository Access (SCP) the additional SR Instance specific keys are defined in Table 4.26-1.

**Table 4.26-1: SR Instance Specific Query Matching and Return Keys**

Attribute Name	Tag	Query Keys Matching		Query Keys Return	
		SCU	SCP	SCU	SCP
<b>SR Instance Specific Level</b>					
Completion Flag	(0040,A491)	R+	R+	R+	R+
Verification Flag	(0040,A493)	R+	R+	R+	R+
Content Date	(0008,0023)	O	O	O	R+
Content Time	(0008,0033)	O	O	O	R+
Observation DateTime	(0040,A032)	O	O	O	R+
Verifying Observer Sequence	(0040,A073)				
>Verifying Organization	(0040,A027)	O	O	R+	R+
>Verification DateTime	(0040,A030)	R+	R+	R+	R+
>Verifying Observer Name	(0040,A075)	R+	R+	R+	R+
>Verifying Observer Identification Code Sequence	(0040,A088)				
>> Code Value	(0008,0100)	O	O	R+	R+
>> Coding Scheme Designator	(0008,0102)	O	O	R+	R+
>> Coding Scheme Version	(0008,0103)	O	O	R+	R+
>> Code Meaning	(0008,0104)	O	O	R+	R+
Referenced Request Sequence	(0040,A370)				
>Study Instance UID	(0020,000D)	O	O	R+*	R+
>Accession Number	(0008,0050)	O	O	R+	R+
>Requested Procedure ID	(0040,1001)	O	O	R+	R+

Attribute Name	Tag	Query Keys Matching		Query Keys Return	
		SCU	SCP	SCU	SCP
>Requested Procedure Code Sequence	(0032,1064)				
>>Code Value	(0008,0100)	O	O	O	R+
>>Coding Scheme Designator	(0008,0102)	O	O	O	R+
>>Coding Scheme Version	(0008,0103)	O	O	O	R+
>>Code Meaning	(0008,0104)	O	O	O	R+
Concept Name Code Sequence	(0040,A043)				
>Code Value	(0008,0100)	R+	R+	R+	R+
>Coding Scheme Designator	(0008,0102)	R+	R+	R+	R+
>Coding Scheme Version	(0008,0103)	O	O	O	R+
>Code Meaning	(0008,0104)	O	O	R+	R+

#### 4.26.4.1.3 Expected Actions

8045 The Report Manager, Report Repository or External Report Repository Access receives the C-FIND request, performs the matching on the provided keys and sends the list of matching records back to the Report Reader via C-FIND responses.

## 4.27 Retrieve Reports [RAD-27]

### 4.27.1 Scope

8050 In the Retrieve Reports Transaction, the requested DICOM Structured Reports are transferred from the Report Manager, Report Repository, Imaging Document Source, or External Report Repository Access to the Report Reader or Imaging Document Consumer for viewing.

### 4.27.2 Actor Roles

**Actor:** Report Repository

8055 **Role:** Sends requested DICOM Structured Reports to Report Reader.

**Actor:** Imaging Document Source

**Role:** Sends requested DICOM Structured Reports to the Imaging Document Consumer.

**Actor:** External Report Repository Access

8060 **Role:** Sends requested DICOM Structured Reports to Report Reader. Such a system may be required to convert reports of different formats (HL7) into DICOM Structured Reports (see RAD TF-2x: Appendix C).

**Actor:** Report Reader

**Role:** Retrieves DICOM Structured Reports from Report Repository or External Report Repository Access and makes them available for viewing.

8065 **Actor:** Imaging Document Consumer

**Role:** Retrieves DICOM Structured Reports from the Imaging Document Source and makes them available for viewing.

**Actor:** Report Manager

**Role:** Sends requested DICOM Structured Reports to Report Reader.

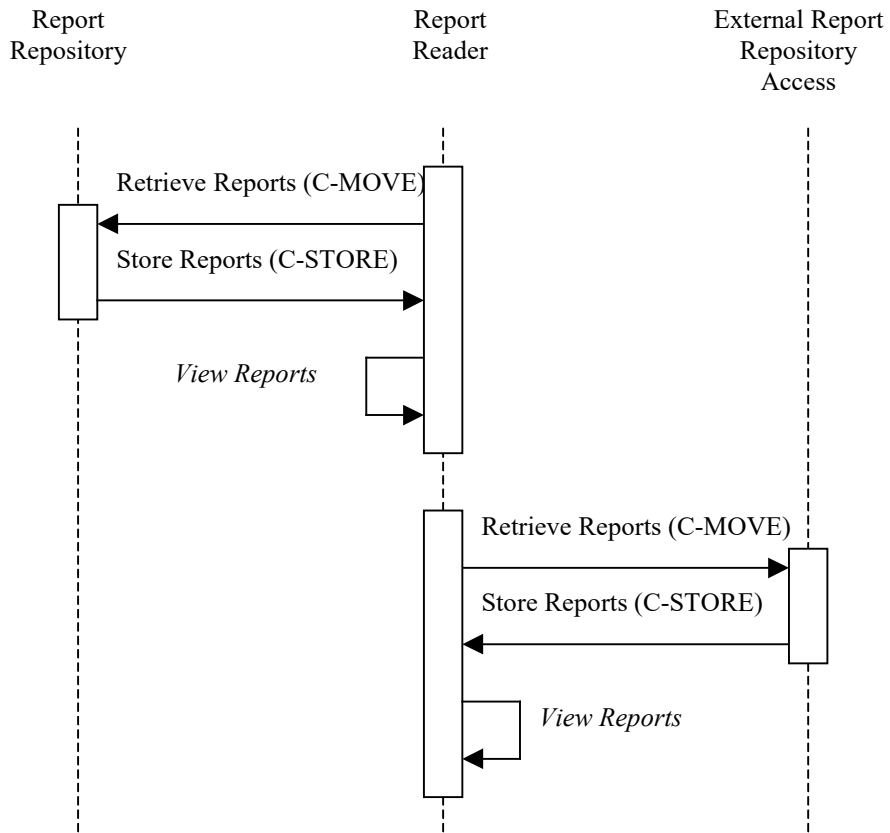
### 8070 4.27.3 Referenced Standards

DICOM [PS3.4 Annex C](#): Query/Retrieve Service Class

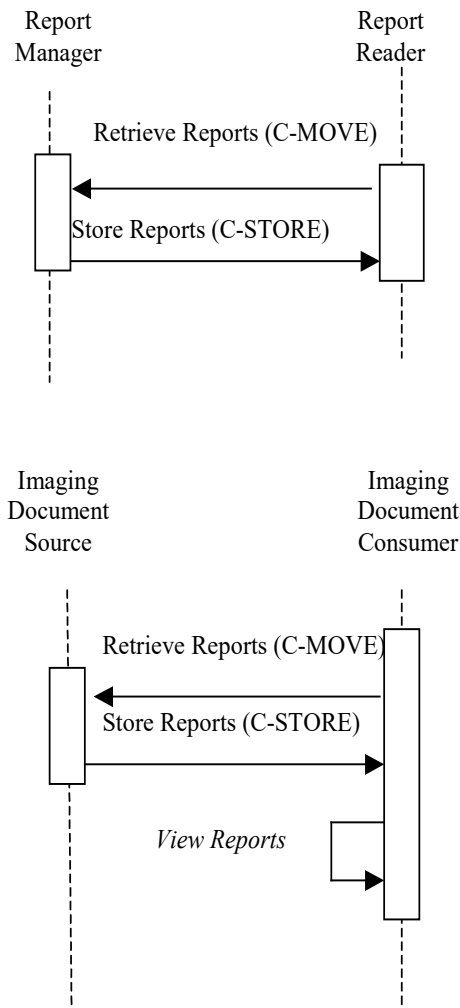
DICOM [PS3.4 Annex B](#): Storage Service Class

DICOM [PS3.16](#): Content Mapping Resource

### 4.27.4 Messages



8075



**Figure 4.27.4-1: Interaction Diagrams**

#### 4.27.4.1 Retrieve Reports

8080 This transaction relates to the retrieve section of the above interaction diagram. The Retrieve (Study Root – MOVE and optionally Patient Root – MOVE) SOP Classes shall be supported. The Report Reader and Imaging Document Consumer as an SCP shall support the DICOM Basic Text SR Storage SOP Class and optionally the DICOM Enhanced SR Storage SOP Class. The Report Manager, Imaging Document Source and the Report Repository as an SCU shall support both the DICOM Basic Text SR Storage SOP Class and the DICOM Enhanced SR Storage SOP Class. The External Report Repository Access as an SCU shall support the DICOM Basic Text SR Storage SOP Class and optionally the DICOM Enhanced SR Storage SOP Class. Refer to DICOM [PS3.4 Annex C](#), for detailed descriptive semantics.

8085

#### **4.27.4.1.1 Trigger Events**

The user at the Report Reader or Imaging Document Consumer selects specific reports to view.

#### 8090 **4.27.4.1.2 Message Semantics**

The DICOM Query/Retrieve SOP Classes and the DICOM Structured Report Storage SOP Classes define the message semantics.

8095 A C-MOVE Request from the DICOM Study Root Query/Retrieve Information Model – MOVE SOP Class or the DICOM Patient Root Query/Retrieve Information Model – MOVE SOP Class shall be sent from the Report Reader to the Report Manager, Report Repository or External Report Repository Access, or from the Imaging Document Consumer to the Imaging Document Source.

#### **4.27.4.1.3 Expected Actions**

8100 The Report Manager, Report Repository, Imaging Document Source or External Report Repository Access receives the C-MOVE request, establishes a DICOM association with the Report Reader or Imaging Document Consumer and uses the appropriate DICOM Structured Report Storage SOP Classes (Basic Text SR Storage SOP Class and/or Enhanced SR Storage SOP Class) to transfer the requested reports.

8105 Report Repository responds to the queries with the information from the DICOM instances it received from the Report Manager. Typically, Report Manager will apply information updates to the instances of reports it holds and re-issue the reports to the Report Repository. To properly update the content of instances that are no longer present on the Report Manager, the update shall be performed by retrieval and re-submission of the report through the Report Manager. It may also be done by grouping the Report Repository and Report Manager.

#### 8110 **4.27.4.2 View Reports**

This transaction relates to the “View Reports” event of the above interaction diagram.

#### **4.27.4.2.1 Trigger Events**

The Report Reader or Imaging Document Consumer receives reports from the Report Repository, Imaging Document Source or External Report Repository Access.

#### 8115 **4.27.4.2.2 Invocation Semantics**

8120 This is a local invocation of functions at the Report Reader or Imaging Document Consumer, and the method used by the Report Reader or Imaging Document Consumer to interpret and display the report data in a meaningful way is outside the scope of the IHE Radiology Technical Framework. At a minimum the Report Reader or Imaging Document Consumer shall be able to correctly display reports defined in RAD TF-1: 9.4. The Report Reader or Imaging Document Consumer shall be able to display reports based on the Simple Image Report (RAD TF-1: 9.4.1). If the Report Reader or Imaging Document Consumer supports the Enhanced SR Information Object Definition then it shall also support display of Simple Image and Numeric Reports (RAD



8125 TF-1: 9.4.2). Even though the IHE Technical Framework sets boundaries on the complexity of SR objects, the Report Reader or Imaging Document Consumer must still be able to receive, store and view any Basic Text SR object and optionally any Enhanced SR object in order to conform to the DICOM Standard. An implementation may not be able to render, in a meaningful way, reports more complex than those specified in RAD TF-1: 9.4.

8130 If a DICOM Structured Report references other DICOM composite objects, such as images, and softcopy presentation states, it is optional for the Report Reader or Imaging Document Consumer to actually retrieve and display/apply these objects, but the Report Reader or Imaging Document Consumer must convey to the user that such references exist in the report.

#### **4.27.4.2.2.1 Retrieve AE Title**

8135 If the Report Reader is grouped with an Image Display and capable of retrieving objects referenced in a DICOM Structured Report then the Report Reader shall retrieve these objects from the device matching the appropriate Retrieve AE Title attribute (0008,0054) included in the DICOM Structured Report. If the Retrieve AE Title attribute is not specified or configured, then the Report Reader may use some other configurable Retrieve AE Title.

8140 In the case of retrieving reports in a Cross-Enterprise, imaging document sharing (XDS-I) network environment, a configuration of mapping the AE Titles to DICOM AE Network Addresses (IP Address and Port number) are needed to be exchanged between the Imaging Document Source and the Imaging Document Consumer. RAD TF-2x: Appendix G describes in detail the AE Title mapping to the DICOM AE Network Addresses.

#### **4.27.4.2.3 Expected Actions**

8145 The Report Reader or Imaging Document Consumer presents to the user a DICOM Structured Report.

## 4.28 Structured Report Export [RAD-28]

### 4.28.1 Scope

8150 In the Structured Report Export transaction, the Report Manager transmits verified Structured Reports as unsolicited HL7 observations to the Enterprise Report Repository. The Report Manager is responsible for mapping DICOM SR to HL7. The Structured Report mapping to the Structured Report Export is defined later in this section.

8155 The report data transmitted in the HL7 message shall be simple ASCII text. The Report Manager shall provide a presentation of the Structured Report consistent with the semantics of the content of the Structured Report and the limitations of ASCII-based rendering.

8160 Due to a wide variety of output devices at the final destination of the HL7 message, special formatting characters shall be avoided. For proper column alignment, the Report Manager shall use space characters as appropriate, since “tab” and other special characters may not be valid, or have inconsistent meaning on the eventual display device.

### 4.28.2 Actor Roles

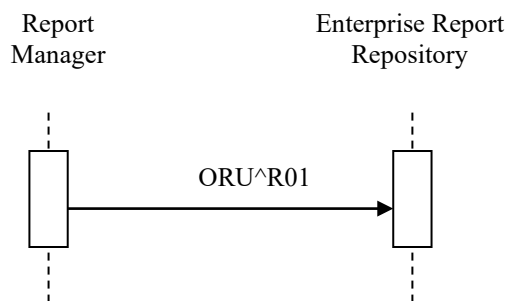
**Actor:** Report Manager

**Role:** Export verified text results to Enterprise Report Repository. This involves mapping DICOM SR terminology to HL7 terminology.

8165 **Actor:** Enterprise Report Repository

**Role:** Accept and store HL7 results transmitted by the Report Manager.

### 4.28.3 Messages



8170

**Figure 4.28.3-1: Interaction Diagram**

#### 4.28.3.1 Structured Report Export

This transaction relates to the ORU event between the Report Manager and the Enterprise Report Repository in the above interaction diagram.

**4.28.3.1.1 Trigger Events**

8175 When DICOM Structured Reports are verified and finalized by the Report Manager, the Report Manager sends unsolicited ORU transactions to the Enterprise Report Repository.

**4.28.3.1.2 Message Semantics**

Refer to the HL7 2.3.1 Standard, Chapter 7 ORU message, for general message semantics.

ORU	Structured Report Export	Chapter in HL7 2.3.1
MSH	Message Header	2
PID	Patient Identification	3
[PV1]	Patient Visit	3 (see Note)
OBR	Order detail	7
{OBX}	Observation Results	7

8180 Note: PV1 is required if use of PV1-19 Visit Number is required per the applicable regional or national extensions to the IHE Technical Framework (see RAD TF-4).

The following tables provide field-by-field definitions of the required segments of the ORU message of the Structured Report Export transaction. These tables shall be interpreted according to the HL7 Standard unless otherwise specified in notes beneath the tables.

8185 **Table 4.28-1: IHE Profile - MSH segment**

SEQ	LEN	DT	OPT	TBL#	ITEM #	ELEMENT NAME
1	1	ST	R		00001	Field Separator
2	4	ST	R		00002	Encoding Characters
3	180	HD	R		00003	Sending Application
4	180	HD	R		00004	Sending Facility
5	180	HD	R		00005	Receiving Application
6	180	HD	R		00006	Receiving Facility
9	7	CM	R		00009	Message Type
10	20	ST	R		00010	Message Control ID
11	3	PT	R		00011	Processing ID
12	60	VID	R	0104	00012	Version ID
18	6	ID	C	0211	00692	Character Set

*Adapted from the HL7 Standard, version 2.3.1*

The IHE Technical Framework requires that applications support HL7-recommended values for the fields MSH-1 Field Separator and MSH-2 Encoding Characters.

8190 Field MSH-9 Message Type shall have at least two components. The first component shall have a value of “ORU”; the second component shall have the value of “R01”. Implementations

supporting sequence number protocol shall be configurable to allow them to perform this transaction without such protocol.

**Table 4.28-2: IHE Profile - PID segment**

SEQ	LEN	DT	OPT	TBL#	ITEM#	ELEMENT NAME
3	20	CX	R		00106	Patient Identifier List
5	48	XPN	R		00108	Patient Name
7	26	TS	R2		00110	Date/Time of Birth
8	1	IS	R2	0001	00111	Sex
10	80	CE	R2	0005	00113	Race
11	106	XAD	R2		00114	Patient Address
18	20	CX	C		00121	Patient Account Number

*Adapted from the HL7 standard, version 2.3.1*

8195

**Table 4.28-3: IHE Profile – PV1 segment**

SEQ	LEN	DT	OPT	TBL#	ITEM#	ELEMENT NAME
2	1	IS	R	0004	00132	Patient Class
19	20	CX	C		00149	Visit Number
51	1	IS	C	0326	01226	Visit Indicator

*Adapted from the HL7 standard, version 2.3.1*

At least one of the fields *PID-18 Patient Account Number* or *PV1-19 Visit Number* shall be valued. Additional requirements for the presence of value in these fields may be documented in regional or national extensions to the IHE Radiology Technical Framework (see RAD TF- 4).

8200 Field *PV1-51 Visit Indicator* shall be valued with value “V” if the field *PV1-19 Visit Number* is present. May be omitted otherwise.

**Table 4.28-4: IHE Profile - OBR Segment**

SEQ	LEN	DT	OPT	TBL#	ITEM #	ELEMENT NAME
1	4	SI	R		00237	Set ID - OBR
2	22	EI	R		00216	Placer Order Number
3	22	EI	R		00217	Filler Order Number
4	200	CE	R		00238	Universal Service ID
7	26	TS	R		00241	Observation Date/Time
25	1	ID	R	0123	00258	Result Status

*Adapted from the HL7 Standard, version 2.3.1*

**Table 4.28-5: IHE Profile - OBX Segment**

SEQ	LEN	DT	OPT	TBL#	ITEM#	ELEMENT NAME
1	4	SI	R		00569	Set ID - OBX
2	3	ID	R	0125	00570	Value Type
3	80	CE	R		00571	Observation Identifier
4	20	ST	C		00572	Observation Sub-ID, See Note.
5	65536 <sup>2</sup>	*	R		00573	Observation Value – may be image directory reference
11	1	ID	R	0085	00579	Observe Result Status

8205

*Adapted from the HL7 Standard, version 2.3.1*

Note: OBX-4 is conditional based on the OBX segment being populated. See Table 4.28-8 for conditions on the OBX-4 field.

#### 4.28.4 DICOM SR to Structured Report Export Mapping

8210

This section defines the mapping of the content of a DICOM SR object (which is the DICOM Enhanced SR Service class) to the HL7 Report Observation message. This message is the HL7 ORU message.

Mappings between HL7 and DICOM are illustrated in the following manner:

- Element Name (HL7 item # - DICOM tag)
- Only required, R, conditionally required, R2, and conditional, C, fields are mapped in the tables below.

8215

**Table 4.28-6: DICOM SR Mapping to Structured Report Export MSH Segment**

SEQ	OPT	TBL#	ITEM#	ELEMENT NAME	DICOM Description / Module	DICOM Tag	Notes
18	C		00693	Character Set	Specific Character Set	0008,0005	

**Table 4.28-7: DICOM SR Mapping to Structured Report Export PID Segment**

SEQ	OPT	TBL#	ITEM#	ELEMENT NAME	DICOM Description / Module	DICOM Tag	Notes
3	R		00106	Patient Identifier List	Patient's ID	(0010,0020)	
5	R		00108	Patient Name	Patient's Name	(0010,0010)	
7	R2		00110	Date/Time of Birth	Patient's Birth Date	(0010,0030)	
8	R2	0001	00111	Sex	Patient's Sex	(0010,0040)	
10	R2	0005	00113	Race	Ethnic Group	(0010,2160)	

<sup>2</sup> The length of the observation value field is variable, depending upon value type. See *OBX-2-value type*.

SEQ	OPT	TBL#	ITEM#	ELEMENT NAME	DICOM Description / Module	DICOM Tag	Notes
18	R		00121	Patient Account Number			See note IHE-1

IHE-1: The Report Manager shall supply the Patient Account Number. It is assumed that the Report Manager is able to obtain the Patient Account Number value.

8220

**Table 4.28-8: DICOM SR Mapping to Structured Report Export OBR Segment**

SEQ	OPT	TBL#	ITEM #	ELEMENT NAME	DICOM Description / Module	DICOM Tag	Notes
1	R		00237	Set ID – OBR			See note IHE-2
2	R		00216	Placer Order Number	SR Document General, Referenced Request Sequence	(0040,2016)	See Note IHE-4
3	R		00217	Filler Order Number	SR Document General, Referenced Request Sequence	(0040,2017)	See Note IHE-4
4	R		00238	Universal Service ID			See Note IHE-3
7	R		00241	Observation DateTime	SR Content Observation DateTime if present, otherwise use the SR Document General, Content Date, Content Time	(0040,A032) or (0008,0023) (0008,0033)	
25	R		00258	Result Status = F			
32	O		00264	Principal Results Interpreter	Person Name value of the Content item that is related to the root of the SR document with the relationship HAS OBS CONTEXT and whose Concept Name Code is (121008,DCM, "Person Observer Name")	(0040,A123)	

IHE-2: If the SR has multiple items in the Referenced Request sequence, the Report Manager will generate separate ORU messages for each item.

IHE-3: The Report Manager shall supply the Universal Service ID from the original order (Placer). It is assumed that the Report Manager is able to obtain the Universal Service ID value.

8225

IHE-4: If the Placer and/or Filler order number are not provided by the Referenced Request Sequence, it is assumed that the Report Manager is able to obtain values.

**Table 4.28-9: DICOM SR Mapping to Structured Report Export OBX Segments**

SEQ	OPT	TBL#	ITEM#	ELEMENT NAME	DICOM Description / Module	DICOM Tag	Notes
<i>The first OBX segment carries the Structured Report Instance UID</i>							
1	R			Set-ID-OBX = 1			
2	R	0125	00070	Value Type = HD			
3	R		00571	Observation Identifier = ^SR Instance UID			
5	R		00573	Observation Value	SR Instance UID	(0008,0018)	
11	R		0085	Observe Result Status=F			
<p><i>The next set of four OBX segments repeats for each IMAGE type Content Item present in the SR content. Each OBX set provides the external report repository the ability to lookup the relevant image references.</i></p> <p><i>The Content Items only provide the Referenced SOP Class UID (0008,1150) and Referenced SOP Instance UID (0008,1155). The Study Instance UID (0020,000D) and Series Instance UID (0020,000E) are found in the corresponding item in the Current Requested Procedure Evidence Sequence (0040,A375) or the Pertinent Other Evidence Sequence (0040,A385). Use the SOP Instance UID to find the correct sequence item. For further details, see Table C.17-2 (SR Document General Module Attributes) and Table C.17-3 (SOP Instance Reference Macro Attributes) in Part 3 of the DICOM Standard.</i></p> <p><i>Each set of four OBX segments that make up an UID reference will have the same unique Observation Sub-ID (OBX 4). The Sub-ID for the first set shall have a value of 1. The Sub-ID shall increment for each subsequent OBX set in the message.</i></p>							
1	R			Set-ID-OBX			
2	R	0125	00070	Value Type = HD			
3	R		00571	Observation Identifier = ^Study Instance UID			
5	R		00573	Observation Value	Current/Pertinent Evidence Sequence, matching item's Study Instance UID	(0020,000D)	
11	R		0085	Observe Result Status=F			
1	R			Set-ID-OBX			
2	R	0125	00070	Value Type = HD			
3	R		00571	Observation Identifier = ^Series Instance UID			
5	R		00573	Observation Value	Current/Pertinent Evidence Sequence, matching item's Series Instance UID	(0020,000E)	

SEQ	OPT	TBL#	ITEM#	ELEMENT NAME	DICOM Description / Module	DICOM Tag	Notes
11	R		0085	Observe Result Status=F			
1	R			Set-ID-OBX			
2	R	0125	00070	Value Type			
3	R		00571	Observation Identifier = ^SOP Instance UID			
5	R		00573	Observation Value	IMAGE Content Item, Referenced SOP Instance UID	(0008,1155)	
11	R		0085	Observe Result Status=F			
1	R			Set-ID-OBX			
2	R	0125	00070	Value Type = HD			
3	R		00571	Observation Identifier = ^SOP Class ID			
5	R		00573	Observation Value	Image Content Item, Referenced SOP Class UID	(0008,1150)	
11	R		0085	Observe Result Status=F			
<i>The report text generated by the Report manager is sent in the next OBX segment(s). No contextual information shall be assumed if multiple OBX segments are used.</i>							
1	R			Set-ID-OBX			
2	R	0125	00070	Value Type = TX			
3	R		00571	Observation Identifier = ^SR Text			
5	R		00573	Observation Value	Report Text from SR Object		
11	R		0085	Observe Result Status=F			

#### 4.28.5 Expected Actions

8230 The Enterprise Report Repository accepts the message. The usage of the result by the Enterprise Report Repository is beyond the scope of the IHE Radiology Technical Framework.

### 4.29 Key Image Note Stored [RAD-29]

#### 4.29.1 Scope

This transaction transmits a DICOM Key Image Note.



8235 **4.29.2 Actor Roles**

The roles in this transaction are defined in the following table and may be played by the actors shown here:

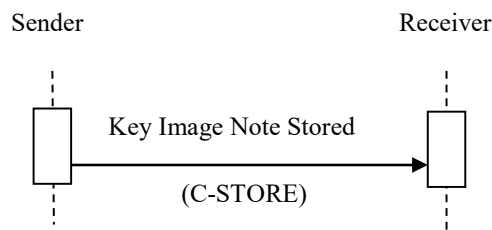
**Table 4.29.2-1: Actor Roles**

<b>Role:</b>	<b>Sender:</b> Flags significant images by creating a Key Object Selection instance and sending it to the Receiver.
<b>Actor(s):</b>	The following actors may play the role of Sender: Acquisition Modality Evidence Creator
<b>Role:</b>	<b>Receiver:</b> Receives and stores Key Object Selection instances.
<b>Actor(s):</b>	The following actors may play the role of Receiver: Imager Manager / Image Archive

**4.29.3 Referenced Standards**

- 8240 DICOM [PS3.3 Section A.35.4](#): Key Object Selection Document IOD  
 DICOM [PS3.4 Annex B](#): Storage Service Class  
 DICOM [PS3.16 TID 2010](#): Key Object Selection

**4.29.4 Messages**



8245 **Figure 4.29.4-1: Interaction Diagram**

**4.29.4.1 Key Image Note Stored Message**

**4.29.4.1.1 Trigger Events**

The Sender determines that DICOM instances need to have particular labels applied and a corresponding Key Image Note stored.

8250 **4.29.4.1.2 Message Semantics**

The message is a DICOM C-STORE of a Key Object Selection instance. The Sender is the SCU. The Receiver is the SCP.

8255 The Sender shall create a new Key Object Selection Storage instance in a new Series of the referenced images' Study. Integration-critical values shall be filled as defined in the Evidence Document Attribute Mapping (RAD TF-2x: Appendix A.2). The instance shall be constructed as defined in DICOM PS3.3 and PS3.4.

The value of the Key Object Selection Document Title code and the Document Title Modifier code(s) may be constrained by the Profile invoking this transaction.

8260 Key Object Selection Documents that reference multi-frame images shall populate the Referenced Frame Number (0008,1160) in each applicable occurrence of the Referenced SOP Sequence (0008,1199) in the Key Object Selection Document, unless the Key Object Selection Document applies to all the frames in the image.

**4.29.4.1.3 Expected Actions**

8265 The Receiver will store the received Key Image Note objects.

## 4.30 Query Key Image Notes [RAD-30]

### 4.30.1 Scope

8270 This section describes the sequence of Transactions required for the Image Display to query the Image Archive for instances of Key Image Notes. The Image Display will query (in order to later retrieve) for Key Image Note objects together with the image objects referenced in the return keys supplied in the response from the Image Archive.

Multiple Key Image Notes may exist that reference the same image data.

### 4.30.2 Actor Roles

**Actor:** Image Display

8275 **Role:** Query for Key Image Notes objects together with the referenced image data and provides a means to indicate that images are flagged as significant. This device will implement the Query/Retrieve SOP Classes in the role of SCU.

**Actor:** Image Archive

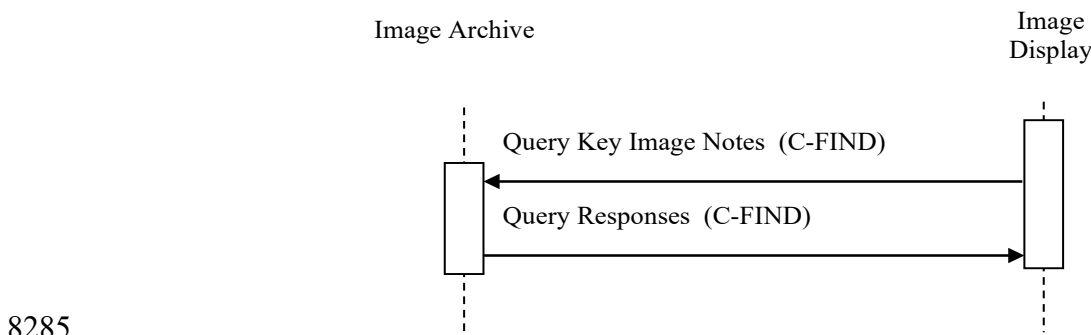
8280 **Role:** Respond to queries from the Image Display for Key Image Notes objects. This device will implement the Query/Retrieve SOP Classes in the role of SCP.

### 4.30.3 Referenced Standards

DICOM [PS3.4 Annex C](#): Query/Retrieve Service Class

DICOM [PS3.3 Section A.36.4](#): Key Object Selection Document IOD

### 4.30.4 Messages



**Figure 4.30.4-1: Interaction Diagram**

#### 4.30.4.1 Query Key Image Notes

8290 This transaction relates to the query section of the above interaction diagram. The Query (Study Root – FIND and optionally Patient Root – FIND) SOP Classes shall be supported. Refer to DICOM PS3.4: Query/Retrieve Service Class for detailed descriptive semantics.

**4.30.4.1.1 Trigger Events**

8295 The user at the Image Display wishes to view Key Image Notes to use as a guide to find significant images. An Image Display may query for Key Image Notes when a new patient is loaded in order to perform internal logic.

**4.30.4.1.2 Message Semantics**

The message semantics are defined by the DICOM Query/Retrieve SOP Classes.

8300 A C-FIND Request from the DICOM Study Root Query/Retrieve Information Model – FIND SOP Class or the DICOM Patient Root Query/Retrieve Information Model – FIND SOP Class shall be sent from the Image Display to the Image Archive.

The Image Display uses one or more matching keys as search criteria to obtain the list of matching entries in the Image Archive at the selected level (Patient & Study/Series/Instance).

8305 In addition to the required and unique keys defined by the DICOM Standard, the IHE Technical Framework has defined matching and return keys to be supported by query SCUs and SCPs. The keys are defined in Section 4.14.4.1.2 and Table 4.14-1. The conventions for key usage are defined in Section 2.2. For the Image Display (SCU) and the Image Archive (SCP) the additional Key Image Note Instances specific keys are defined in Table 4.30-1.

**Table 4.30-1: Key Image Note Instance Specific Query Matching and Return Keys**

Attribute Name	Tag	Query Keys Matching		Query Keys Return	
		SCU	SCP	SCU	SCP
<b>Key Instance Note Instance Specific Level</b>					
Content Date	(0008,0023)	O	O	O	R+
Content Time	(0008,0033)	O	O	O	R+
Observation DateTime	(0040,A032)	O	O	O	R+
Referenced Request Sequence	(0040,A370)				
>Study Instance UID	(0020,000D)	O	O	R+*	R+
>Accession Number	(0008,0050)	O	O	R+	R+
>Requested Procedure ID	(0040,1001)	O	O	R+	R+
>Requested Procedure Code Sequence	(0032,1064)				
>>Code Value	(0008,0100)	O	O	O	R+
>>Coding Scheme Designator	(0008,0102)	O	O	O	R+
>>Coding Scheme Version	(0008,0103)	O	O	O	R+
>>Code Meaning	(0008,0104)	O	O	O	R+
Concept Name Code Sequence (Note 1)	(0040,A043)				
>Code Value	(0008,0100)	R+	R+	R+	R+
>Coding Scheme Designator	(0008,0102)	R+	R+	R+	R+
>Coding Scheme Version	(0008,0103)	O	O	O	R+

Attribute Name	Tag	Query Keys Matching		Query Keys Return	
		SCU	SCP	SCU	SCP
>Code Meaning	(0008,0104)	O	O	R+	R+

8310 Note1: The Concept Name Code Sequence of the root content item conveys the Key Image Note Title. The list of applicable codes can be found in CID 7010 (Key Object Selection Document Title) in DICOM PS3.16.

#### 4.30.4.1.3 Expected Actions

The Image Archive receives the C-FIND request, performs the matching on the provided keys and sends the list of matching records back to the Image Display via C-FIND responses.

8315 The Image Archive participating in the Imaging Object Change Management Integration Profile shall include or not include matching records related to specific KOS instances that mark rejected or corrected images as defined in Sections 4.66.4.1.3 and 4.66.4.2.3.

8320 The Image Archive participating in the Imaging Object Change Management Integration Profile shall also include or not include matching records related to specific KOS instances that mark rejected or corrected images as defined in Sections 4.66.4.3.3 and 4.66.4.4.3.

## 4.31 Retrieve Key Image Notes [RAD-31]

### 4.31.1 Scope

8325 In the Retrieve Key Image Notes Transaction, the requested DICOM Key Image Notes are transferred from the Image Manager or Imaging Document Source to the Image Display or Imaging Document Consumer for viewing along with the images flagged by the Key Image Note.

### 4.31.2 Actor Roles

**Actor:** Image Archive

**Role:** Sends requested Key Image Notes to the Image Display.

8330 **Actor:** Imaging Document Source

**Role:** Sends requested Key Image Notes to the Imaging Document Consumer.

**Actor:** Image Display

**Role:** Receives requested Key Image Notes from the Image Archive.

**Actor:** Imaging Document Consumer

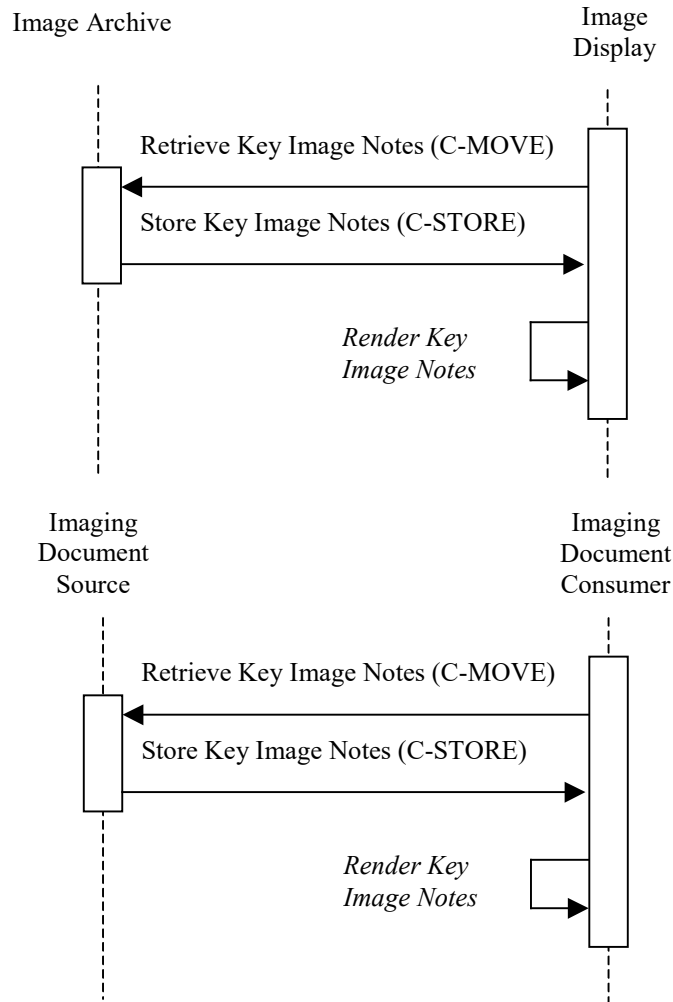
8335 **Role:** Receives requested Key Images Notes from the Imaging Document Source.

### 4.31.3 Referenced Standards

DICOM [PS3.4 Annex C](#): Query/Retrieve Service Class

DICOM [PS3.3 Section A.36.4](#): Key Object Selection Document IOD

### 4.31.4 Messages



8340

**Figure 4.31.4-1: Interaction Diagrams**

#### 4.31.4.1 Retrieve Key Image Notes

8345 The Retrieve (Study Root – MOVE and optionally Patient Root – MOVE) SOP Classes will be supported. The Image Archive and Imaging Document Source as an SCU shall support DICOM Image Storage SOP Classes. Refer to DICOM [PS3.4 Annex C](#), for detailed descriptive semantics.

##### 4.31.4.1.1 Trigger Events

8350 The Image Display or Imaging Document Consumer selects specific Key Image Note objects to retrieve from the Image Archive or Imaging Document Source.

#### **4.31.4.1.2 Message Semantics**

8355 The message semantics are defined in the DICOM Query/Retrieve Service Class. It is the responsibility of the Image Manager to assure that the patient and procedure information is current in the images and Key Image Note objects when they are retrieved from the Image Archive. It is the responsibility of the Imaging Document Source to assure that the patient and procedure information is current in the Key Image Note objects when they are retrieved from this actor.

#### **4.31.4.1.3 Expected Actions**

8360 The Image Archive or Imaging Document Source receives the C-MOVE request, establishes a DICOM association with the Image Display or Imaging Document Consumer, and uses the DICOM Key Image Note Storage SOP Class to transfer the requested Key Image Note objects.

The Image Archive participating in the Imaging Object Change Management Integration Profile shall include or not include specific KOS instances that mark rejected images as defined in Section 4.66.4.1.3.

#### **8365 4.31.4.2 Render Key Image Notes**

This transaction relates to the “Render Key Image Notes” event of the above interaction diagram. Key Image Notes cannot be rendered separately, but must be applied to images. Refer to Section 4.16 for a description of the transaction used to retrieve images to which Key Image Notes may be applied.

8370 The Image Display or Imaging Document Consumer is not required to, but may choose to, support retrieval and display of images from other studies than the one to which the Key Image Note belongs.

#### **4.31.4.2.1 Trigger Events**

8375 The Image Display or Imaging Document Consumer receives Key Image Note instances from the Image Archive or Imaging Document Source.

#### **4.31.4.2.2 Invocation Semantics**

8380 This is a local invocation of functions resident within the Image Display or Imaging Document Consumer. The method used by the Image Display or Imaging Document Consumer to present images for viewing by the user flagged by the Key Image Notes is outside the scope of the IHE Radiology Technical Framework.

#### **4.31.4.2.2.1 Retrieve AE Title**

8385 If the Image Display is capable of retrieving objects referenced in a DICOM Key Image Note then it shall retrieve these objects from the device matching the appropriate Retrieve AE Title attribute (0008,0054) included in the DICOM Key Image Note. If the Retrieve AE Title attribute is not specified or configured, then the Image Display shall use some other configurable Retrieve AE Title.



8390 In the case of retrieving DICOM Key Image Notes in a Cross-Enterprise, imaging document sharing (XDS-I) network environment, a configuration of mapping the AE Titles to DICOM AE Network Addresses (IP Address and Port number) are needed to be exchanged between the Imaging Document Source and the Imaging Document Consumer. RAD TF-2x: Appendix G describes in detail the AE Title mapping to the DICOM AE Network Addresses.

#### 4.31.4.2.3 Expected Actions

The Image Display or Imaging Document Consumer flags the images and renders the Key Image Note.

8395 Note: It is recommended to use the just retrieved instance of the Key Image Note to ensure that the most recent patient data be displayed to reflect possible patient merge and patient update in the Image Manager/Image Archive or Imaging Document Source. This patient data may be inconsistent with patient data contained in a previously retrieved copy of the same Key Image Note instance.

#### 4.31.4.2.3.1 Intentionally Left Blank

8400 **4.31.4.2.3.2 Presentation of rejected or incorrect images in Imaging Object Change Management**

An Image Display participating in the Imaging Object Change Management Integration Profile may receive Key Image Notes.

8405 When an Image Display receives a Key Image Note with Key Object Selection (KOS) Document Title valued (113001, DCM, "Rejected for Quality Reasons"). The Image Display shall support the three behaviors listed below. The behavior shall be configurable as one of the following:

- Suppress from presentation the rejected instances referenced in this KOS and this KOS itself
  - Present the rejected instances referenced in this KOS and this KOS itself
  - 8410 • Ignore this KOS and present the rejected instances.
  - When an Image Display receives a Key Image Note with the Key Object Selection (KOS) Document Title valued (113037, DCM, "Rejected for Patient Safety Reasons"), (113038, DCM, "Incorrect Modality Worklist Entry"), or (113039, DCM, "Data Retention Policy Expired"), it shall suppress the KOS and its referenced rejected instances from presentation.
- 8415

### 4.32 Authenticate Node - Deprecated

This transaction is identical to, and has been superseded by, the Authenticate Node [ITI-19] ([ITI TF-2: 3.19](#)) transaction as part of the ITI Audit Trail and Node Authentication Profile.

### 4.33 Maintain Time - Deprecated

8420 This transaction is identical to, and has been superseded by, the Maintain Time [ITI-1] ([ITI TF-2: 3.1](#)) transaction as part of the ITI Consistent Time Profile ([ITI TF-2: 3.1](#)).

### 4.34 Record Audit Event - Deprecated

8425 This transaction has been superseded by the Record Audit Event [ITI-20] ([ITI TF-2: 3.20](#)) transaction as part of the ITI Audit Trail and Node Authentication Profile and the Radiology Audit Trail Option described in RAD TF-3: 5.1. While the Record Audit Event [ITI-20] transaction extends this deprecated transaction, it is still backward compatible.

### 4.35 Charge Posted [RAD-35]

#### 4.35.1 Scope

8430 The Charge Posted Transaction specifies a message from the Department System Scheduler/Order Filler to the Charge Processor. This HL7 Financial Transaction message contains procedure data typically needed to generate a claim.

8435 The Department System Scheduler/Order Filler provides the procedure data that is used by the Charge Processor. The Charge Processor may or may not expect the actual transaction fees associated with the procedures included in the transaction. In some situations, the Department System Scheduler/Order Filler is best able to match the procedure details to the appropriate fees. In other situations, the Charge Processor performs this function. In either case, the Charge Processor can override the fees provided by the Department System Scheduler/Order Filler.

The ways and means of ensuring the required data is complete is the responsibility of the Charge Processor and is outside the scope of IHE.

8440 Note: although IHE specifies real-time charge posted transactions, batch processing can be accommodated as per the batch specifications defined in HL7 v2.3.1 Chapter 2, sec. 2.23.2 or HL7 v2.5.1 Chapter 2, sec 2.10.2.

#### 4.35.2 Actor Roles

**Actor:** Department System Scheduler/Order Filler

8445 **Role:** Collects information relevant to the posting of charges and submits it to the Charge Processor.

**Actor:** Charge Processor

**Role:** Receives the information from the Department System Scheduler/Order Filler. Processes and combines charges in order to issue an insurance claim or patient's billing statement.

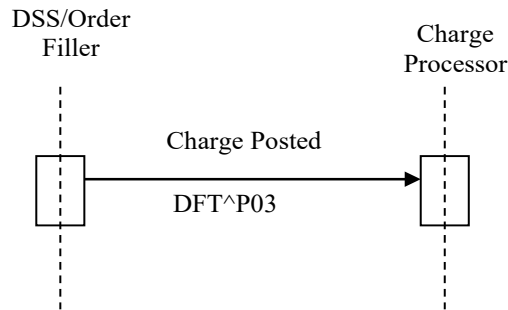
#### 8450 4.35.3 Referenced Standards

HL7, Version 2.3.1: Chapter 6 - Financial Management

HL7, Version 2.5.1: Chapter 6 – Financial Management

DICOM [PS3.4 Section F.7](#): Modality Performed Procedure Step SOP Class

### 4.35.4 Messages



8455

**Figure 4.35.4-1: Interaction Diagram**

#### 4.35.4.1 Financial Transaction Message

The Detailed Financial Transaction (DFT) message is used to describe a financial transaction transmitted between the Department System Scheduler/Order Filler and the Charge Processor.

8460 Note that sometimes the DFT does not actually result in a financial transaction.

##### 4.35.4.1.1 Trigger Events

The Department System Scheduler/Order Filler determines when the charge posted transactions are to be sent to the Charge Processor. There are two types of financial billing transactions – Technical and Professional. Each can be triggered at a separate time or both can be sent at the same time - depending on the site configuration.

8465

- Technical Billing

Charge posting of the Technical Billing for a procedure is typically triggered when the procedure is completed. The Performed Procedure Step Manager sends the MPPS Completed message to the Department System Scheduler/Order Filler. The Department System Scheduler/Order Filler is now aware that the procedure has been completed and sends the technical charge information to the Charge Processor.

8470

Technical Billing for certain post-processing operations, such as Mammography CAD, is triggered when the Department System Scheduler/Order Filler receive confirmation from the Post-processing Manager that the step has been completed. The Department System Scheduler receives this confirmation by grouping with Post-Processing Manager; if Post-Processing Manager is grouped with Image Manager, Charge Posting of the Professional Billing will be triggered by the Performed Work Status Update message to the Department System Scheduler/Order Filler that specifies completion of the post-processing operation.

8475

- Professional Billing

Charge posting of the Professional Billing is triggered when a report is completed/verified by the radiologist. When the Department System Scheduler/Order

8480

Filler is aware that the report is completed it sends the professional charge information to the Charge Processor.

8485 The Department System Scheduler/Order Filler may receive confirmation from the Report Manager that the report has been completed and verified. Department System Scheduler receives this confirmation by grouping with Report Manager. If Report Manager implements the Reporting Workflow Profile, Charge Posting of the Professional Billing will be triggered by the Performed Work Status Update transaction that specifies completion of the report.

8490

#### 4.35.4.1.2 Message Semantics

This transaction defines both HL7 v2.3.1 Message Semantics and HL7 v2.5.1 Message Semantics. Except for the certain references and segment tables (which are labeled as "HL7 v2.3.1" or "HL7 v2.5.1"), all requirements in this section apply to both HL7 v2.3.1 and HL7 v2.5.1. Profiles using this transaction will specify which message semantics its actors are required to support.

8495

The Department System Scheduler/Order Filler uses the DFT message to convey necessary charge posting information to the Charge Processor. The Charge Processor shall obtain the related Patient Demographic information from the ADT Patient Registration transaction generally received earlier.

8500

The Department System Scheduler/Order Filler uses information from the Modality Performed Procedure Step Completed/Discontinued transaction to verify the procedure has been completed. This information can also include the DICOM Billing and Material Management Code Module which provides procedure, materials and devices information.

8505 The Charge Posted Transaction will transmit Detailed Financial Transactions (DFT) messages using the P03 event.

One or more PR1 segments shall be present if additional procedures, materials or devices are present. It may be absent otherwise.

Note: Additional qualifications to the level of specification and HL7 profiling are stated in Section 2.3.

8510 Required segments are defined below. Other segments are optional

DFT Segment	Detailed Financial Transaction Message	Chapter in HL7
MSH	Message Header	2
EVN	Event Type	3
PID	Patient Identification	3
[PV1]	Patient Visit	3 (see note)
{FT1	Financial Transaction	6
[{PR1}]}	Procedure	6

Note: PV1 is required if use of PV1-19 Visit Number is required per the applicable regional or national extensions to the IHE Radiology Technical framework (see RAD TF-4).

8515 Each message shall be acknowledged by the HL7 ACK message sent by the receiver of the DFT message to its sender. See Section 2.4.3 “Acknowledgement Modes” (HL7 v2.3.1) or Section 2.4.4.1 “Acknowledgement Message” (HL7 v2.5.1) for definition and discussion of the ACK message.

**4.35.4.1.2.1 MSH Segment**

8520 The MSH segment shall be constructed as defined in Section 2.4.2.2.2 (HL7 v2.3.1) or 2.4.4.2 (HL7 v2.5.1) “Message Control”.

Field *MSH-9 Message Type* shall have at least two components. The first component shall have a value of “DFT”; the second component shall have value of P03.

**4.35.4.1.2.2 EVN Segment**

8525 The EVN segment is used to communicate necessary trigger event information to receiving applications. See Section 4.1.4.1.2.1.2 (HL7 v2.3.1) or Section 4.1.4.1.2.2.2 (HL7 v2.5.1) for required and optional fields of the EVN segment.

**4.35.4.1.2.3 PID Segment**

All of the fields in PID segment are optional, except those listed in Table 4.35-1 (HL7 v2.3.1) or Table 4.35-1a (HL7 v2.5.1).

8530

**Table 4.35-1: IHE Profile - PID segment - HL7 v2.3.1**

SEQ	LEN	DT	OPT	TBL#	ITEM#	ELEMENT NAME
3	20	CX	R		00106	Patient Identifier List
5	48	XPN	R		00108	Patient Name
18	20	CX	C		00121	Patient Account Number
19	16	ST	O		00122	SSN Number - Patient

*Adapted from the HL7 standard, version 2.3.1*

**Table 4.35-1a: IHE Profile - PID segment – HL7 v2.5.1**

SEQ	LEN	DT	OPT	TBL#	ITEM#	ELEMENT NAME
3	250	CX	R		00106	Patient Identifier List
5	250	XPN	R		00108	Patient Name
18	250	CX	C		00121	Patient Account Number
19	16	DT	O		01222	SSN Number - Patient

*Adapted from the HL7 standard, version 2.5.1*

8535 At least one of the fields *PID-18 Patient Account Number* or *PV1-19 Visit Number* shall be valued.

**4.35.4.1.2.4 PV1 Segment**

All of the fields in PV1 segment are optional, except those listed in Table 4.35-2 (HL7 v2.3.1) or Table 4.35-2a (HL7 v2.5.1).

**Table 4.35-2: IHE Profile - PV1 Segment – HL7 v2.3.1**

SEQ	LEN	DT	OPT	TBL#	ITEM#	ELEMENT NAME
2	1	IS	R	0004	00132	Patient Class
19	20	CX	C		00149	Visit Number
51	1	IS	C	0326	01226	Visit Indicator

8540

*Adapted from the HL7 standard, version 2.3.1*

**Table 4.35-2a: IHE Profile - PV1 Segment – HL7 v2.5.1**

SEQ	LEN	DT	OPT	TBL#	ITEM#	ELEMENT NAME
2	1	IS	R	0004	00132	Patient Class
19	250	CX	C		00149	Visit Number
51	1	IS	C	0326	01226	Visit Indicator

*Adapted from the HL7 standard, version 2.5.1*

At least one of the fields *PID-18 Patient Account Number* or *PV1-19 Visit Number* shall be valued.

8545

Field *PV1-51 Visit Indicator* shall be valued with value “V” if the field *PV1-19 Visit Number* is present. May be omitted otherwise.

**4.35.4.1.2.5 FT1 Segment**

The FT1 segment is used to post charges, credits, payments, and adjustments to patient accounting records. The DSS/OF shall map values from ADT and ORM messages into the FT1 segment as defined in Table 4.35-3 (HL7 v2.3.1) or Table 4.35-3a (HL7 v2.5.1).

8550

**Table 4.35-3: IHE Profile - FT1 Segment – HL7 v2.3.1**

SEQ	LEN	DT	OPT	TBL#	ITEM#	ELEMENT NAME
1	4	SI	O		00355	Set ID - FT1
2	12	ST	O		00356	Transaction ID
3	10	ST	O		00357	Transaction Batch ID
4	26	TS	R		00358	Transaction Date
5	26	TS	R		00359	Transaction Posting Date
6	8	IS	R	0017	00360	Transaction Type
7	80	CE	R	0132	00361	Transaction Code
8	40	ST	O		00362	Transaction Description
9	40	ST	O		00363	Transaction Description - Alt
10	6	NM	O		00364	Transaction Quantity

SEQ	LEN	DT	OPT	TBL#	ITEM#	ELEMENT NAME
11	12	CP	O		00365	Transaction Amount - Extended
12	12	CP	O		00366	Transaction Amount - Unit
13	60	CE	O	0049	00367	Department Code
14	60	CE	O	0072	00368	Insurance Plan ID
15	12	CP	O		00369	Insurance Amount
16	80	PL	O		00133	Assigned Patient Location
17	1	IS	O	0024	00370	Fee Schedule
18	2	IS	O	0018	00148	Patient Type
19	60	CE	O	0051	00371	Diagnosis Code - FT1
20	120	XCN	R	0084	00372	Performed By Code
21	120	XCN	R		00373	Order By Code
22	12	CP	O		00374	Unit Cost
23	22	EI	R		00217	Filler Order Number
24	120	XCN	O		00765	Entered By Code
25	80	CE	R	0088	00393	Procedure Code
26	80	CE	O	0340	01316	Procedure Code Modifier

*Adapted from the HL7 standard, version 2.3.1*

**Table 4.35-3a: IHE Profile - FT1 Segment - HL7 v2.5.1**

SEQ	LEN	DT	OPT	TBL#	ITEM#	ELEMENT NAME
1	4	SI	O		00355	Set ID - FT1
2	12	ST	O		00356	Transaction ID
3	10	ST	O		00357	Transaction Batch ID
4	53	DR	R		00358	Transaction Date
5	26	TS	R		00359	Transaction Posting Date
6	8	IS	R	0017	00360	Transaction Type
7	250	CE	R	0132	00361	Transaction Code
8	40	ST	O		00362	Transaction Description
9	40	ST	O		00363	Transaction Description - Alt
10	6	NM	O		00364	Transaction Quantity
11	12	CP	O		00365	Transaction Amount - Extended
12	12	CP	O		00366	Transaction Amount - Unit
13	250	CE	O	0049	00367	Department Code
14	150	CE	O	0072	00368	Insurance Plan ID
15	12	CP	O		00369	Insurance Amount
16	80	PL	O		00133	Assigned Patient Location
17	1	IS	O	0024	00370	Fee Schedule
18	2	IS	O	0018	00148	Patient Type
19	250	CE	O	0051	00371	Diagnosis Code - FT1

SEQ	LEN	DT	OPT	TBL#	ITEM#	ELEMENT NAME
20	250	XCN	R	0084	00372	Performed By Code
21	250	XCN	R		00373	Order By Code
22	12	CP	O		00374	Unit Cost
23	427	EI	R		00217	Filler Order Number
24	120	XCN	O		00765	Entered By Code
25	250	CE	R	0088	00393	Procedure Code
26	250	CE	O	0340	01316	Procedure Code Modifier
27	250	CE	O	0339	01310	Advanced Beneficiary Notice Code
28	250	CWE	O	0476	01646	Medically Necessary Duplicate Procedure Reason
29	250	CWE	O	0549	01845	NDC Code
30	250	CX	O		01846	Payment Reference ID
31	4	SI	O		01847	Transaction Reference Key

*Adapted from the HL7 standard, version 2.5.1*

#### 8555 4.35.4.1.2.6 PR1 Segment – Procedures

The PR1 segment contains information relative to various types of procedures that can be performed on a patient. The PR1 segment can be used to send procedure information, for example: Surgical, Nuclear Medicine, X-Ray with contrast, etc. The PR1 segment is used to send multiple procedures, for example, for medical records encoding or for Charge Processors. The DSS/OF shall map values from ADT and ORM messages into the PR1 segment as defined in Table 4.35-4 (HL7 v2.3.1) or Table 4.35-4a (HL7 v2.5.1).

8560

**Table 4.35-4: PR1 Attributes – HL7 v2.3.1**

SEQ	LEN	DT	OPT	TBL#	ITEM#	ELEMENT NAME
1	4	SI	R		00391	Set ID - PR1
2	2	IS	R	0089	00392	Procedure Coding Method
3	80	CE	R	0088	00393	Procedure Code (see note)
4	40	ST	O		00394	Procedure Description
5	26	TS	R		00395	Procedure Date/Time
6	2	IS	R	0230	00396	Procedure Functional Type
7	4	NM	O		00397	Procedure Minutes
8	120	XCN	O	0010	00398	Anesthesiologist
9	2	IS	O	0019	00399	Anesthesia Code
10	4	NM	O		00400	Anesthesia Minutes
11	120	XCN	O	0010	00401	Surgeon
12	230	XCN	O	0010	00402	Procedure Practitioner
13	60	CE	O	0059	00403	Consent Code
14	2	NM	O		00404	Procedure Priority
15	80	CE	O	0051	00772	Associated Diagnosis Code



SEQ	LEN	DT	OPT	TBL#	ITEM#	ELEMENT NAME
16	80	CE	O	0340	01316	Procedure Code Modifier (see note)

*Adapted from the HL7 standard, version 2.3.1*

Note: Each PR1 segment will contain only one procedure code or one modifier code.

8565

**Table 4.35-4a: PR1 Attributes – HL7 v2.5.1**

SEQ	LEN	DT	OPT	TBL#	ITEM#	ELEMENT NAME
1	4	SI	R		00391	Set ID - PR1
2	3	IS	R	0089	00392	Procedure Coding Method
3	250	CE	R	0088	00393	Procedure Code (see note)
4	40	ST	O		00394	Procedure Description
5	26	TS	R		00395	Procedure Date/Time
6	2	IS	R	0230	00396	Procedure Functional Type
7	4	NM	O		00397	Procedure Minutes
8	250	XCN	O	0010	00398	Anesthesiologist
9	2	IS	O	0019	00399	Anesthesia Code
10	4	NM	O		00400	Anesthesia Minutes
11	250	XCN	O	0010	00401	Surgeon
12	250	XCN	O	0010	00402	Procedure Practitioner
13	250	CE	O	0059	00403	Consent Code
14	2	NM	O		00404	Procedure Priority
15	250	CE	O	0051	00772	Associated Diagnosis Code
16	250	CE	O	0340	01316	Procedure Code Modifier (see note)
17	20	IS	O	0416	01501	Procedure DRG Type
18	250	CE	O	0417	01502	Tissue Type Code
19	427	EI	C		01848	Procedure Identifier
20	1	ID	C	0206	01849	Procedure Action Code

*Adapted from the HL7 standard, version 2.5.1*

Note: Each PR1 segment will contain only one procedure code or one modifier code.

#### 4.35.4.2 Sources of Information

The Charge Posted Transaction derives its data from three sources which are described below. Tables 4.35-5 and 4.35-6 describe the mapping of the fields in the FT1 segment and the PR1 segment.

- **Order Management – HL7 order messages [RAD-3] and [RAD-3]**

The Order Placer General Order Message provides the Department System Scheduler/Order Filler with the required Charge Posted Transaction fields to be used in the PID Segment. See Sections 4.2 and 4.3 for required and optional fields.

8570

8575

- **Modality Performed Procedure Step [RAD-7]**

8580

The Modality General Order Message provides the Department System Scheduler/Order Filler with the required Charge Posted Transaction fields to be used in the FT1 segment and the PR1 segment. There may be additional procedures, or supplies information contained in the DICOM Billing Materials and Management message. See Section 4.7 (Modality Procedure Step Completed/Discontinued) for required and optional fields.

8585

The message semantics are defined in the DICOM Service Class Section of the DICOM Modality Performed Procedure Step SOP Class. It is the responsibility of the Acquisition Modality to ensure that the procedure information is sent to the Department System Scheduler/Order Filler.

- **Manual Posting/Department System Scheduler/Order Filler (DSS/OF)**

8590

Manual entry of Charge Posted Transaction information is also supported. This enables the Department System Scheduler/Order Filler to collect information that is not being provided by the Modality or the Order Placer and is required by the Charge Processor. This data can be manually entered into or is a function of the Department System Scheduler/Order Filler.

**Table 4.35-5: Mapping of the FT1 Segment**

FT1 Field	Field Definition	OPT	HL7 order messages – [RAD-2] and [RAD-3]	Modality Performed Procedure Step [RAD-7]	Manual Input – DSS/OF
Transaction Date	Date of the transaction. For example, this field would be used to identify the date a procedure, item, or test was conducted or used. It may be defaulted to today’s date.	R		Performed Procedure Step End Date (0040,0004) + Performed Procedure Step End Time (0040,0005)	Generated by Department System Scheduler/Order Filler if there is no MPPS
Transaction Posting Date	Date of the transaction that was sent to the financial system for posting.	R			Generated by Department System Scheduler/Order Filler Use today’s date.
Transaction Type	Code that identifies the type of transaction. Values: CG – Charge CD – Credit PY – Payment AJ – Adjustment	R			Generated by Department System Scheduler/Order Filler

FT1 Field	Field Definition	OPT	HL7 order messages – [RAD-2] and [RAD-3]	Modality Performed Procedure Step [RAD-7]	Manual Input – DSS/OF
Transaction Code	Code assigned by the institution for the purpose of uniquely identifying the transaction. For example, this field would be used to uniquely identify a procedure, supply item, or test for charging purposes.	R		Billing Item Sequence (0040, 0296) Note: If the Billing Item Sequence is blank then use Procedure Code Sequence (0008, 1032)	
Transaction Quantity	Quantity of items associated with this transaction	O		Quantity Sequence (0040,0293)	Generated by Department System Scheduler/Order Filler if there is no MPPS.
Transaction Amount - Extended	The amount of a transaction. It may be left blank if the transaction is automatically priced. Total price for multiple items.	O			Generated by Department System Scheduler/Order Filler
Transaction Amount - Unit	Unit price of a transaction. Price of a single item.	O			Generated by Department System Scheduler/Order Filler.
Department Code	The department code that controls the transaction code described above.	O			Generated by Department System Scheduler/Order Filler.
Insurance Plan ID	The identifier of the primary insurance plan with which this transaction shall be associated	O			Generated by Department System Scheduler/Order Filler.
Insurance Amount	The amount to be posted to the insurance plan referenced above.	O			Generated by Department System Scheduler/Order Filler.
Assigned Patient Location	This field contains the current patient location. This can be the location of the patient when the charge item was ordered or when the charged service was rendered.	O	PV1-3 – Assigned Patient Location (ADT)		
Fee Schedule	This field contains the code used to select the appropriate fee schedule to be used for this transaction posting.	O			

FT1 Field	Field Definition	OPT	HL7 order messages – [RAD-2] and [RAD-3]	Modality Performed Procedure Step [RAD-7]	Manual Input – DSS/OF
Patient Type	This field contains the type code assigned to the patient for this episode of care (visit or stay).	O			
Diagnosis Code – FT1	This field contains the primary diagnosis code for billing purposes. ICD9 CM is assumed for all diagnosis codes. This is the most current diagnosis code that has been assigned to the patient. ICD10 can also be used. The name of coding system (third component) indicates which coding system is used.	O			
Performed By Code	This field contains the composite number/name of the person/group that performed the test/procedure/transaction, etc. This is the service provider.	R		Performing Physician's Name (0008,1050) Note: May be repeated.	Generated by Department System Scheduler/Order Filler if there is no MPPS.
Order By Code	This field contains the composite number/name of the person/group that ordered the test/ procedure/transaction, etc.	R	ORC-12 Ordering Provider (ORM)		
Unit Cost	This field contains the unit cost of transaction. The cost of a single item.	O			Generated by Department System Scheduler/Order Filler.
Filler Order Number	This field is used when the billing system is requesting observational reporting justification for a charge. This is the number used by a filler to uniquely identify a result.	R	ORC-3 Filler Order Number (ORM)		
Entered By Code	This field identifies the composite number/name of the person who entered the insurance information.	O	ORC-10 Entered By (ORM)		
Procedure Code	This field contains a unique identifier assigned to the procedure, if any, associated with the charge.	R		Procedure Code Sequence (0008, 1032)	

FT1 Field	Field Definition	OPT	HL7 order messages – [RAD-2] and [RAD-3]	Modality Performed Procedure Step [RAD-7]	Manual Input – DSS/OF
Procedure Code Modifier	This field contains the procedure code modifier to the procedure code reported in field 25, when applicable. Procedure code modifiers are defined by regulatory agencies such as HCFA and the AMA.	O			Generated by Department System Scheduler/Order Filler. Use “TC” for Technical Component. Use “26” for Professional Component Other modifiers may be included as repetitions of the field.

**Table 4.35-6: Mapping of the PR1 Segment**

PR1 Field	Field Definition	OPT	HL7 order messages – [RAD-2] and [RAD-3]	Modality Performed Procedure Step [RAD-7]	Manual Input/Department System Scheduler/Order Filler
Set ID - PR1	A number that identifies this transaction. For the first occurrence of the segment the sequence number shall be 1, for the second occurrence it shall be 2, etc.	R			Generated by Department System Scheduler/Order Filler
Procedure Code	This field contains a unique identifier assigned to the procedure.	R		Billing Procedure Step Sequence (0040,0320)	Generated by Department System Scheduler/Order Filler if there is no MPPS.
Procedure Date/Time	This field contains the date/time that the procedure was performed	R		Performed Procedure Step End Date (0040,0004) + Performed Procedure Step End Time (0040,0005) Note: Use the last MPPS of the Procedure	Generated by Department System Scheduler/Order Filler if there is no MPPS.
Procedure Functional Type	The optional code that further defines the type of procedure. Values: A – Anesthesia	R			Generated by Department System Scheduler/Order Filler.

PR1 Field	Field Definition	OPT	HL7 order messages – [RAD-2] and [RAD-3]	Modality Performed Procedure Step [RAD-7]	Manual Input/Department System Scheduler/Order Filler
	P – Procedure for treatment I – Invasive procedure not classified D – Diagnostic procedure				
Procedure Code Modifier	This field contains the procedure code modifier to the procedure code reported in field 3, when applicable.	O			Generated by Department System Scheduler/Order Filler or Charge Processor. Use “TC” for Technical Component. Use “26” for Professional Component. Other modifiers may be included as repetitions of the field. Modifier may be absent in a case of global billing.

8595

#### 4.35.4.3 Expected Actions

The Charge Processor will receive and process the technical billing or professional billing details in the DFT message according to the capabilities of its application. This processing is not defined or constrained by IHE.

### 8600 4.36 Account Management [RAD-36]

#### 4.36.1 Scope

The Account Management Transaction specifies messages from the ADT Patient Registration to the Charge Processor. These messages are sent when the account for the patient is set-up, updated, or closed.

8605 Use of this transaction minimizes the information needed to be sent to the Department System Scheduler/Order Filler such as insurance or guarantor information. The Charge Processor receives this information directly from the ADT system.

#### 4.36.2 Actor Roles

**Actor:** ADT Patient Registration

8610 **Role:** Collects information relevant to the account patient and submits it to the Charge Processor.

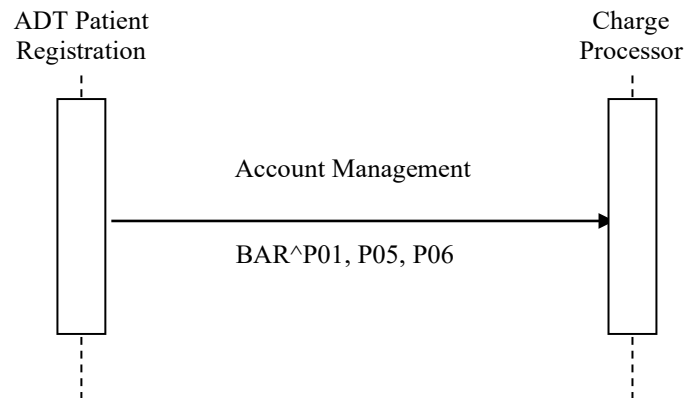
**Actor:** Charge Processor

**Role:** Receives the information from Patient Registration. Processes and combines charges in order to issue an insurance claim or patient’s billing statement.

### 4.36.3 Referenced Standards

8615 HL7, Version 2.3.1: Chapter 6 - Financial Management

### 4.36.4 Messages



**Figure 4.36.4-1: Interaction Diagram**

#### 4.36.4.1 Account Management - New Account

8620 The Account Management message is used to describe a patient account information transaction transmitted between the ADT Patient Registration and the Charge Processor. Data is sent from the ADT Patient Registration application to the patient accounting or financial system to establish an account for a patient’s billing/accounts receivable record. This message enables the Charge Processor to process the patient claim after the procedure charge is received.

#### 8625 4.36.4.1.1 Trigger Events

Creation of a new account will typically occur as a result of one of the following ADT Patient registration events:

- Admission of an in-patient into a facility
- Registration of an outpatient for a visit of the facility
- Pre-admission of an in-patient (i.e., registration of patient information ahead of actual admission).

8630

Creation of an account will result in the following Account Management message:

- P01 – Add Patient Account.

**4.36.4.1.2 Message Semantics**

8635 The Account Management transaction is conducted by the HL7 BAR message. The ADT Actor shall generate the message whenever a patient is admitted, pre-admitted or registered. The P01 event shall only be used to add a new account that did not exist before, not to update an existing account. The new P05 (update account) event shall be used to update an existing account. The new P06 (end account) event shall be used to close an account.

8640 One or more DG1 segments shall be present if patient’s diagnosis is known at the time of Account creation. It may be absent otherwise.

One or more GT1 segments shall be present if Guarantor (even if it is patient itself) is known at the time of Account creation. It may be absent otherwise.

8645 One or more IN1 segments shall be present if insurance information about patient is known at the time of Account creation. It may be absent otherwise.

Note: Additional qualifications to the level of specification and HL7 profiling are stated in Section 2.3.

The segments of the **Add Patient Account** message listed below are required, and the detailed description of messages is provided in the following subsections.

BAR Segment	Billing Account	Chapter in HL7 2.3.1
MSH	Message Header	2
EVN	Event Type	3
PID	Patient Identification	3
[PV1]	Patient Visit	3 (see Note)
[{DG1}]	Diagnosis	6
[{GT1}]	Guarantor	6
[{IN1}]	Insurance	6

8650 Note: PV1 is required if use of *PV1-19 Visit Number* is required per the applicable regional or national extensions to the IHE Radiology Technical Framework (see RAD TF-4).

Each message shall be acknowledged by the HL7 ACK message sent by the receiver of the BAR message to its sender. See Section 2.4.3 “Acknowledgement Modes” for definition and discussion of the ACK message.

8655 **4.36.4.1.2.1 MSH Segment**

The MSH segment shall be constructed as defined in Section 2.4.2.2.2 “Message Control”.

Field MSH-9 Message Type shall have at least two components. The first component shall have a value of “BAR”; the second component shall have the value of P01.

**4.36.4.1.2.2 EVN Segment**

8660 The EVN segment is used to communicate necessary trigger event information to receiving applications. See Section 4.1.4.1.2.1.2 for required and optional fields of the EVN segment.



**4.36.4.1.2.3 PID Segment**

All of the fields in PID segment are optional, except those listed in Table 4.36-1. See Section 4.1.4.1.2.1.3 for the list of all fields of the PID segment.

8665

**Table 4.36-1: IHE Profile - PID segment**

SEQ	LEN	DT	OPT	TBL#	ITEM#	ELEMENT NAME
3	20	CX	R		00106	Patient Identifier List
5	48	XPN	R		00108	Patient Name
18	20	CX	C		00121	Patient Account Number

*Adapted from the HL7 standard, version 2.3.1*

**4.36.4.1.2.4 PV1 Segment**

Most of the fields in PV1 segment are optional, except those listed in Table 4.36-2. See Section 4.1.4.1.2.1.4 for the list of all fields of the PV1 segment.

8670

**Table 4.36-2: IHE Profile - PV1 Segment**

SEQ	LEN	DT	OPT	TBL#	ITEM#	ELEMENT NAME
2	1	IS	R	0004	00132	Patient Class
19	20	CX	C		00149	Visit Number
51	1	IS	C	0326	01226	Visit Indicator

*Adapted from the HL7 standard, version 2.3.1*

At least one of the fields *PID-18 Patient Account Number* or *PV1-19 Visit Number* shall be valued. Additional requirements for the presence of value in these fields may be documented in regional or national extensions to the IHE Radiology Technical Framework (see RAD TF-4).

8675 Field *PV1-51 Visit Indicator* shall be valued with value “V” if the field *PV1-19 Visit Number* is present. May be omitted otherwise.

**4.36.4.1.2.5 DG1 Segment**

8680

The DG1 segment contains patient diagnosis information of various types, for example, admitting, primary, etc. The DG1 segment is used to send multiple diagnoses (for example, for medical records encoding). It is also used when the FT1-19 Diagnosis Code does not provide sufficient information for a billing system. This diagnosis coding shall be distinguished from the clinical problem segment used by caregivers to manage the patient. Table 4.36-3 lists the required and optional attributes of the DG1 segment.

**Table 4.36-3: IHE Profile - DG1 Segment**

SEQ	LEN	DT	OPT	TBL#	ITEM#	ELEMENT NAME
1	4	SI	R		00375	Set ID - DG1
2	2	ID	O	0053	00376	Diagnosis Coding Method

SEQ	LEN	DT	OPT	TBL#	ITEM#	ELEMENT NAME
3	60	CE	O	0051	00377	Diagnosis Code - DG1
4	40	ST	O		00378	Diagnosis Description
5	26	TS	O		00379	Diagnosis Date/Time
6	2	IS	R	0052	00380	Diagnosis Type
7	60	CE	O	0118	00381	Major Diagnostic Category
8	60	CE	O	0055	00382	Diagnostic Related Group
9	2	ID	O	0136	00383	DRG Approval Indicator
10	2	IS	O	0056	00384	DRG Grouper Review Code
11	60	CE	O	0083	00385	Outlier Type
12	3	NM	O		00386	Outlier Days
13	12	CP	O		00387	Outlier Cost
14	4	ST	O		00388	Grouper Version And Type
15	2	ID	O		00389	Diagnosis Priority
16	60	XCN	O		00390	Diagnosing Clinician
17	3	IS	O	0228	00766	Diagnosis Classification
18	1	ID	O	0136	00767	Confidential Indicator
19	26	TS	O		00768	Attestation Date/Time

8685 **4.36.4.1.2.6 GT1 Segment**

The GT1 segment contains guarantor (e.g., the person or the organization with financial responsibility for payment of a patient account) data for patient and insurance billing applications. Table 4.36-4 lists the required and optional attributes of the GT1 segment.

**Table 4.36-4: IHE Profile - GT1 Segment**

SEQ	LEN	DT	OPT	TBL#	ITEM#	ELEMENT NAME
1	4	SI	R		00405	Set ID - GT1
2	59	CX	O		00406	Guarantor Number
3	48	XPN	R		00407	Guarantor Name
4	48	XPN	O		00408	Guarantor Spouse Name
5	106	XAD	O		00409	Guarantor Address
6	40	XTN	O		00410	Guarantor Ph Num-Home
7	40	XTN	O		00411	Guarantor Ph Num-Business
8	26	TS	O		00412	Guarantor Date/Time Of Birth
9	1	IS	O	0001	00413	Guarantor Sex
10	2	IS	O	0068	00414	Guarantor Type
11	80	CE	O	0063	00415	Guarantor Relationship
12	11	ST	O		00416	Guarantor SSN
13	8	DT	O		00417	Guarantor Date - Begin
14	8	DT	O		00418	Guarantor Date - End

IHE Radiology Technical Framework, Volume 2 (TF-2): Transactions

SEQ	LEN	DT	OPT	TBL#	ITEM#	ELEMENT NAME
15	2	NM	O		00419	Guarantor Priority
16	130	XPN	O		00420	Guarantor Employer Name
17	106	XAD	O		00421	Guarantor Employer Address
18	40	XTN	O		00422	Guarantor Employer Phone Number
19	20	CX	O		00423	Guarantor Employee ID Number
20	2	IS	O	0066	00424	Guarantor Employment Status
21	130	XON	O		00425	Guarantor Organization Name
22	1	ID	O	0136	00773	Guarantor Billing Hold Flag
23	80	CE	O	0341	00774	Guarantor Credit Rating Code
24	26	TS	O		00775	Guarantor Death Date And Time
25	1	ID	O	0136	00776	Guarantor Death Flag
26	80	CE	O	0218	00777	Guarantor Charge Adjustment Code
27	10	CP	O		00778	Guarantor Household Annual Income
28	3	NM	O		00779	Guarantor Household Size
29	20	CX	O		00780	Guarantor Employer ID Number
30	80	CE	O	0002	00781	Guarantor Marital Status Code
31	8	DT	O		00782	Guarantor Hire Effective Date
32	8	DT	O		00783	Employment Stop Date
33	2	IS	O	0223	00755	Living Dependency
34	2	IS	O	0009	00145	Ambulatory Status
35	80	CE	O	0171	00129	Citizenship
36	60	CE	O	0296	00118	Primary Language
37	2	IS	O	0220	00742	Living Arrangement
38	80	CE	O	0215	00743	Publicity Code
39	1	ID	O	0136	00744	Protection Indicator
40	2	IS	O	0231	00745	Student Indicator
41	80	CE	O	0006	00120	Religion
42	48	XPN	O		00746	Mother's Maiden Name
43	80	CE	O	0212	00739	Nationality
44	80	CE	O	0189	00125	Ethnic Group
45	48	XPN	O		00748	Contact Person's Name
46	40	XTN	O		00749	Contact Person's Phone Number
47	80	CE	O	0222	00747	Contact Reason
48	2	IS	O	0063	00784	Contact Relationship
49	20	ST	O		00785	Job Title
50	20	JCC	O	0327/ 0328	00786	Job Code/Class

SEQ	LEN	DT	OPT	TBL#	ITEM#	ELEMENT NAME
51	130	XON	O		01299	Guarantor Employer's Organization Name
52	2	IS	O	0295	00753	Handicap
53	2	IS	O	0311	00752	Job Status
54	50	FC	O	0064	01231	Guarantor Financial Class
55	80	CE	O	0005	01291	Guarantor Race

8690 **4.36.4.1.2.7 IN1 Segment**

The IN1 segment contains insurance policy coverage information necessary to produce properly pro-rated and patient and insurance bills. Table 4.36-5 lists the required and optional attributes of the IN1 segment.

**Table 4.36-5: IHE Profile - IN1 Segment**

SEQ	LEN	DT	OPT	TBL#	ITEM #	ELEMENT NAME
1	4	SI	R		00426	Set ID - IN1
2	60	CE	R	0072	00368	Insurance Plan ID
3	59	CX	R		00428	Insurance Company ID
4	130	XON	O		00429	Insurance Company Name
5	106	XAD	O		00430	Insurance Company Address
6	48	XPN	O		00431	Insurance Co Contact Person
7	40	XTN	O		00432	Insurance Co Phone Number
8	12	ST	O		00433	Group Number
9	130	XON	O		00434	Group Name
10	12	CX	O		00435	Insured's Group Emp ID
11	130	XON	O		00436	Insured's Group Emp Name
12	8	DT	O		00437	Plan Effective Date
13	8	DT	O		00438	Plan Expiration Date
14	55	CM	O		00439	Authorization Information
15	3	IS	O	0086	00440	Plan Type
16	48	XPN	O		00441	Name Of Insured
17	80	CE	O	0063	00442	Insured's Relationship To Patient
18	26	TS	O		00443	Insured's Date Of Birth
19	106	XAD	O		00444	Insured's Address
20	2	IS	O	0135	00445	Assignment Of Benefits
21	2	IS	O	0173	00446	Coordination Of Benefits
22	2	ST	O		00447	Coord Of Ben. Priority
23	1	ID	O	0136	00448	Notice Of Admission Flag
24	8	DT	O		00449	Notice Of Admission Date
25	1	ID	O	0136	00450	Report Of Eligibility Flag

SEQ	LEN	DT	OPT	TBL#	ITEM #	ELEMENT NAME
26	8	DT	O		00451	Report Of Eligibility Date
27	2	IS	O	0093	00452	Release Information Code
28	15	ST	O		00453	Pre-Admit Cert (PAC)
29	26	TS	O		00454	Verification Date/Time
30	60	XCN	O		00455	Verification By
31	2	IS	O	0098	00456	Type Of Agreement Code
32	2	IS	O	0022	00457	Billing Status
33	4	NM	O		00458	Lifetime Reserve Days
34	4	NM	O		00459	Delay Before L.R. Day
35	8	IS	O	0042	00460	Company Plan Code
36	15	ST	O		00461	Policy Number
37	12	CP	O		00462	Policy Deductible
38	12	CP	O		00463	Policy Limit - Amount
39	4	NM	O		00464	Policy Limit - Days
40	12	CP	O		00465	Room Rate - Semi-Private
41	12	CP	O		00466	Room Rate - Private
42	60	CE	O	0066	00467	Insured's Employment Status
43	1	IS	O	0001	00468	Insured's Sex
44	106	XAD	O		00469	Insured's Employer's Address
45	2	ST	O		00470	Verification Status
46	8	IS	O	0072	00471	Prior Insurance Plan ID
47	3	IS	O	0309	01227	Coverage Type
48	2	IS	O	0295	00753	Handicap
49	12	CX	O		01230	Insured's ID Number

8695 **4.36.4.1.3 Expected Actions**

It is expected that after receiving Add Patient Account message the receiving system will create and maintain the account information for the patient for purpose of utilizing it when processing charges.

**4.36.4.2 Account Management – Update Account**

8700 **4.36.4.2.1 Trigger Events**

Changes to patient account information (e.g., change in patient name, patient address, guarantor, insurance, etc.) shall trigger the following Update Account message:

P05 – Update Account Information

**4.36.4.2.2 Message Semantics**

8705 The Account Management transaction is conducted by the HL7 BAR message. The ADT Actor shall generate the message whenever patient account information changed. The P05 (update account) event shall only be used to update an existing account. The new P06 (end account) event shall be used to close an account.

8710 All of the required (R and R2) information for a patient record shall be re-sent in a P05 message. Any information received as NULL (i.e., transmitted as two double quote marks "") in the P05 message shall be removed from the receiving system's database for that patient record. If no value is sent (i.e., omitted) in the P05 message, the old value shall remain unchanged in the receiving system's database for that patient record.

**Note:** Additional qualifications to the level of specification and HL7 profiling are stated in Section 2.3.

8715 The segments of the **Update Account Information** message listed below are required, and the detailed description of the message is provided in Section 4.36.4.1.2.5. One or more DG1 segments shall be present if a patient’s diagnosis is changed. One or more GT1 segments shall be present if Guarantor information is updated. One or more IN1 segments shall be present if insurance information is added or modified.

8720

BAR Segment	Billing Account	Chapter in HL7 2.3.1
MSH	Message Header	2
EVN	Event Type	3
PID	Patient Identification	3
[PV1]	Patient Visit	3 (see note)
[{DG1}]	Diagnosis	6
[{GT1}]	Guarantor	6
[{IN1}]	Insurance	6

Note: PV1 is required if use of *PV1-19 Visit Number* is required per the applicable regional or national extensions to the IHE Radiology Technical Framework (see RAD TF-4).

8725 Each message shall be acknowledged by the HL7 ACK message sent by the receiver of the BAR message to its sender. See Section 2.4.3 “Acknowledgement Modes” for definition and discussion of the ACK message.

**4.36.4.2.2.1 MSH Segment**

The MSH segment shall be constructed as defined in Section 2.4.2.2.2 “Message Control”.

Field MSH-9 Message Type shall have at least two components. The first component shall have a value of “BAR”; the second component shall have the value of P05.

8730 **4.36.4.2.2.2 EVN Segment**

The EVN segment is used to communicate necessary trigger event information to receiving applications. See Section 4.1.4.1.2.1.2 for required and optional fields of the EVN segment.

#### 4.36.4.2.2.3 PID Segment

8735 All of the fields in PID segment are optional, except those listed in Table 4.36-6. See Section 4.1.4.1.2.1.3 for the list of all fields of the PID segment.

**Table 4.36-6: IHE Profile - PID segment**

SEQ	LEN	DT	OPT	TBL#	ITEM#	ELEMENT NAME
3	20	CX	R		00106	Patient Identifier List
5	48	XPN	R		00108	Patient Name
18	20	CX	C		00121	Patient Account Number

*Adapted from the HL7 standard, version 2.3.1*

#### 4.36.4.2.2.4 PV1 Segment

8740 Most of the fields in PV1 segment are optional, except those listed in Table 4.36-7. See Section 4.1.4.1.2.1.4 for the list of all fields of the PV1 segment.

**Table 4.36-7: IHE Profile - PV1 Segment**

SEQ	LEN	DT	OPT	TBL#	ITEM#	ELEMENT NAME
2	1	IS	R	0004	00132	Patient Class
19	20	CX	C		00149	Visit Number
51	1	IS	C	0326	01226	Visit Indicator

*Adapted from the HL7 standard, version 2.3.1*

8745 At least one of the fields *PID-18 Patient Account Number* or *PV1-19 Visit Number* shall be valued. Additional requirements for the presence of value in these fields may be documented in regional or national extensions to the IHE Radiology Technical Framework (see RAD TF-4).

Field *PV1-51 Visit Indicator* shall be valued with value “V” if the field *PV1-19 Visit Number* is present. May be omitted otherwise.

#### 4.36.4.2.2.5 DG1 Segment

See Section 4.36.4.1.2.5 for required and optional fields of the DG1 segment.

#### 8750 4.36.4.2.2.6 GT1 Segment

See Section 4.36.4.1.2.6 for required and optional fields of the GT1 segment.

#### 4.36.4.2.2.7 IN1 Segment

See Section 4.36.4.1.2.7 for required and optional fields of the IN1 segment.

**4.36.4.2.3 Expected Actions**

8755 It is expected that after receiving Update Account Information message the receiving system will update its local patient demographic, diagnosis, guarantor, and/or insurance information. Any information received as null in the new P05 message shall be removed locally.

**4.36.4.3 Account Management – End Account**

**4.36.4.3.1 Trigger Events**

8760 Ending or closing of an account will typically occur as a result of patient discharge or visit end and will result in the following Account Management message:  
P06 – End Account.

**4.36.4.3.2 Message Semantics**

8765 The Account Management transaction is conducted by the HL7 BAR message. The ADT Actor shall generate the message whenever a patient is closed. The new P06 (end account) event shall be used to close an account.

**Note:** Additional qualifications to the level of specification and HL7 profiling are stated in Section 2.3.

The segments of the **End Account** message listed below are required, and the detailed description of messages is provided in the following subsections.

8770

BAR Segment	Billing Account	Chapter in HL7 2.3.1
MSH	Message Header	2
EVN	Event Type	3
PID	Patient Identification	3
[PV1]	Patient Visit	3 (see Note)

**Note:** PV1 is required if use of *PV1-19 Visit Number* is required per the applicable regional or national extensions to the IHE Radiology Technical Framework (see RAD TF-4).

8775 Each message shall be acknowledged by the HL7 ACK message sent by the receiver of ADT message to its sender. See Section 2.4.3 “Acknowledgement Modes” for definition and discussion of the ACK message.

**4.36.4.3.2.1 MSH Segment**

The MSH segment shall be constructed as defined in Section 2.4.2.2.2 “Message Control”.

Field MSH-9 Message Type shall have at least two components. The first component shall have a value of “BAR”; the second component shall have value of P06.

8780 **4.36.4.3.2.2 EVN Segment**

The EVN segment is used to communicate necessary trigger event information to receiving applications. See Section 4.1.4.1.2.1.2 for required and optional fields of the EVN segment.



#### 4.36.4.3.2.3 PID Segment

8785 All of the fields in PID segment are optional, except those listed in Table 4.36-8. See Section 4.1.4.1.2.1.3 for the list of all fields of the PID segment.

**Table 4.36-8: IHE Profile - PID segment**

SEQ	LEN	DT	OPT	TBL#	ITEM#	ELEMENT NAME
3	20	CX	R		00106	Patient Identifier List
5	48	XPN	R		00108	Patient Name
18	20	CX	C		00121	Patient Account Number

*Adapted from the HL7 standard, version 2.3.1*

#### 4.36.4.3.2.4 PV1 Segment

8790 Most of the fields in PV1 segment are optional, except those listed in Table 4.36-9. Section 4.1.4.1.2.1.4 for the list of all fields of the PV1 segment.

**Table 4.36-9: IHE Profile - PV1 Segment**

SEQ	LEN	DT	OPT	TBL#	ITEM#	ELEMENT NAME
2	1	IS	R	0004	00132	Patient Class
19	20	CX	C		00149	Visit Number
51	1	IS	C	0326	01226	Visit Indicator

*Adapted from the HL7 standard, version 2.3.1*

8795 At least one of the fields *PID-18 Patient Account Number* or *PV1-19 Visit Number* shall be valued. Additional requirements for the presence of value in these fields may be documented in regional or national extensions to the IHE Radiology Technical Framework (see RAD TF-4).

Field *PV1-51 Visit Indicator* shall be valued with value “V” if the field *PV1-19 Visit Number* is present. May be omitted otherwise.

#### 4.36.4.3.3 Expected Actions

8800 It is expected that after receiving End Account message (P06) the receiving system will update its local patient account information to reflect the fact that the account has been closed.

### 4.37 Query Post-Processing Worklist [RAD-37]

#### 4.37.1 Scope

8805 This transaction is used during post-processing by the Evidence Creator to find out what tasks have been scheduled by the Post-Processing Manager. The transaction describes generically the worklist being provided for post-processing related workitem codes for Image Processing, Computer Aided Diagnosis, and Computer Aided Detection.

8810 The Post-Processing Manager is the provider of the worklist. It obtains the necessary information with either grouping with the Department System Scheduler or the Image Manager. The Evidence Creator retrieves the worklist and includes received information in the resulting instances, which are stored through instance stored transactions such as Evident Document Stored, Image Stored, etc.

#### 4.37.2 Actor Roles

**Actor:** Evidence Creator

**Role:** Query the Post-Processing Manager for post-processing Scheduled Procedure Steps.

8815 **Actor:** Post-Processing Manager

**Role:** Schedule post-processing procedure steps for the workitems of Image Processing, Computer Aided Diagnosis, and Computer Aided Detection; accept requests for Worklist items, perform the query and return response.

#### 4.37.3 Referenced Standards

8820 DICOM [PS3.4](#): General Purpose Worklist SOP Class

#### 4.37.4 Messages

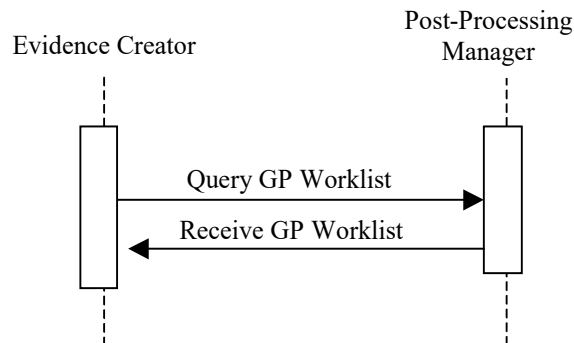


Figure 4.37.4-1: Interaction Diagram

#### 4.37.4.1 Query General Purpose Worklist Message

8825 This is the worklist query sent to the Post-Processing Manager.

##### 4.37.4.1.1 Trigger Events

A user or an automated function on the Evidence Creator queries for scheduled post-processing worklist items.

##### 4.37.4.1.2 Message Semantics

8830 C-FIND request of the DICOM General Purpose Worklist SOP Class is used to query for the general purpose worklist. Evidence Creator performs the SCU role, and the Post-Processing Manager performs the SCP role.

#### 4.37.4.1.2.1 Matching Keys and Return Keys

8835 The Evidence Creator is required to query for specific attributes (return keys) that will be inserted into the instances created as a result of post-processing. See Appendix D for more details.

The Evidence Creator shall support individually each one of the required query keys listed in Table 4.37-4 - Return and Matching Keys for Post-Processing Worklist Queries. In addition, at least one of the following three combinations shall be implemented by the Evidence Creator:

8840 **1. Patient Oriented Query:** Query for a worklist for a specific patient/procedure. The SCU shall support all (31) combinations of the matching key attributes listed in Table 4.37-1 by including one or more keys. The sequence attributes denoted in the italics are not matching keys on their own but have to be included in a query to convey the value of the attributes contained within them. Thus, the SCU shall support any combination of Patient's Name, Patient ID, Accession  
8845 Number, Requested Procedure ID, and Scheduled Workitem Code.

**Table 4.37-1: GPWL Keys for Patient Oriented Query**

Matching Key Attributes	Tag
Patient's Name	(0010,0010)
Patient ID	(0010,0020)
<i>Referenced Request Sequence</i>	<i>(0040,A370)</i>
>Accession Number	(0008,0050)
>Requested Procedure ID	(0040,1001)
<i>Scheduled Workitem Code Sequence</i>	<i>(0040,4018)</i>
>Code Value	(0008,0100)
>Coding Scheme Designator	(0008,0102)

8850 **2. Station-oriented Query:** Query for a broad worklist for particular workstation. The SCU shall support all (15) combinations of the matching key attributes listed in Table 4.37-2 by including 1 or more keys. The sequence attributes denoted in the italics are not matching keys on their own but have to be included in a query to convey the value of the attributes contained within them. Code Value of the Scheduled Station Name Code Sequence, if valued, shall be set to the AE Title of the workstation's General Purpose Worklist SCU.

**Table 4.37-2: GPWL Keys for Station-Oriented Queries**

Matching Key Attributes	Tag
General Purpose Scheduled Procedure Step Status	(0040,4001)
<i>Scheduled Station Name Code Sequence</i>	<i>(0040,4025)</i>
>Code Value	(0008,0100)
>Coding Scheme Designator	(0008,0102)
Scheduled Procedure Step Start Date and Time	(0040,4005)
<i>Scheduled Workitem Code Sequence</i>	<i>(0040,4018)</i>

Matching Key Attributes	Tag
>Code Value	(0008,0100)
>Coding Scheme Designator	(0008,0102)

8855

**3. The Class-oriented Query:** Query for a broad worklist for a particular class of workstations. The SCU shall support all (15) combinations of the matching key attributes listed in Table 4.37-3 by including 1 or more keys. The sequence attributes denoted in the italics are not matching keys on their own but have to be included in a query to convey the value of the attributes contained within them.

8860

**Table 4.37-3: GPWL Keys for Class-Oriented Worklist Queries**

Matching Key Attributes	Tag
General Purpose Scheduled Procedure Step Status	(0040,4001)
<i>Scheduled Station Class Code Sequence</i>	<i>(0040,4026)</i>
>Code Value	(0008,0100)
>Coding Scheme Designator	(0008,0102)
Scheduled Procedure Step Start Date and Time	(0040,4005)
<i>Scheduled Workitem Code Sequence</i>	<i>(0040,4018)</i>
>Code Value	(0008,0100)
>Coding Scheme Designator	(0008,0102)

#### 4.37.4.1.2.2 Examples for the Use of Matching Key Attributes

- Using the Scheduled Procedure Step Start Date and Time key: query for all the post-processing tasks scheduled for today.
- Using the Scheduled Workitem Code key: query for all computer-aided detection (CAD) tasks.
- Using Scheduled Station Name key: query for all the post-processing tasks that are scheduled for this workstation.
- Using the Scheduled Procedure Step Start Date and Time, Scheduled Workitem Code and Scheduled Station Class Code keys: query for all the Image Processing tasks that are scheduled for today on CT 3D reconstruction workstations.

8865

8870

Note: Applications are recommended to append a wildcard "\*" at the end of each component of the structured Patient Name to facilitate matching with both structured and unstructured Patient Names.

#### 4.37.4.1.2.3 Matching Keys and Return Keys

The Evidence Creator is required to query for specific attributes (return keys), many of which will be required in the objects it creates. The requirements for the attributes in the stored objects are defined in RAD TF-2x: Appendix C. There are additional attributes that may be queried.

8875

8880

Table 4.37-4 summarizes the matching key requirements and lists the optional and required attributes that may be requested and shall be returned in order to make these available to the user at the Evidence Creator. See Section 2.2 for more information on conventions used in this table.

**Table 4.37-4: Matching and Return Keys for Post-Processing Worklist Queries**

Attribute Name	Tag	Query Keys Matching		Query Keys Return	
		SCU	SCP	SCU	SCP
<b>SOP Common</b>					
Specific Character Set	(0008,0005)	O	O	O	R
SOP Class UID	(0008,0016)	O	O	R+*	R
SOP Instance UID	(0008,0018)	O	R	R+*	R
<b>General Purpose Scheduled Procedure Step Information</b>					
General Purpose Scheduled Procedure Step Status	(0040,4001)	R+	R	R+	R
Input Availability Flag	(0040,4020)	O	R	R+	R
General Purpose Scheduled Procedure Step Priority	(0040,4003)	O	R	R+	R
Scheduled Procedure Step ID	(0040,0009)	O	O	O	R
Scheduled Workitem Code Sequence	(0040,4018)				
>Code Value	(0008,0100)	R+	R	R+*	R
>Coding Scheme Designator	(0008,0102)	R+	R	R+*	R
>Code Meaning	(0008,0104)	-	-	R+	R
Scheduled Processing Applications Code Sequence	(0040,4004)				
>Code Value	(0008,0100)	O	R	R+*	R
>Coding Scheme Designator	(0008,0102)	O	R	R+*	R
>Code Meaning	(0008,0104)	-	-	R+	R
Scheduled Station Name Code Sequence	(0040,4025)				
>Code Value	(0008,0100)	R+	R	R+*	R
>Coding Scheme Designator	(0008,0102)	R+	R	R+*	R
>Code Meaning	(0008,0104)	-	-	R+*	R
Scheduled Station Class Code Sequence	(0040,4026)				
>Code Value	(0008,0100)	R+	R	R+*	R
>Coding Scheme Designator	(0008,0102)	R+	R	R+*	R
>Code Meaning	(0008,0104)	-	-	R+*	R
Scheduled Station Geographic Location Code Sequence	(0040,4027)				
>Code Value	(0008,0100)	O	R	O	R
>Coding Scheme Designator	(0008,0102)	O	R	O	R

Attribute Name	Tag	Query Keys Matching		Query Keys Return	
		SCU	SCP	SCU	SCP
>Code Meaning	(0008,0104)	-	-	O	R
Scheduled Procedure Step Start Date and Time	(0040,4005)	R+	R	R+	R
Expected Completion Date and Time	(0040,4011)	O	R	O	R
Scheduled Human Performers Sequence	(0040,4034)				
>Human Performer Code Sequence	(0040,4009)				
>>Code Value	(0008,0100)	O	R	O	R
>>Coding Scheme Designator	(0008,0102)	O	R	O	R
>>Code Meaning	(0008,0104)	-	-	O	R
>Human Performer's Name	(0040,4037)	O	O	O	R+
>Human Performer's Organization	(0040,4036)	O	O	O	R+
Referenced Study Component Sequence	(0008,1111)				
>Referenced SOP Class UID	(0008,1150)	O	O	O	R
>Referenced SOP Instance UID	(0008,1155)	O	O	O	R
Input Information Sequence	(0040,4021)				
>Study Instance UID	(0020,000D)	O	O	R+*	R
>Referenced Series Sequence	(0008,1115)				
>>Series Instance UID	(0020,000E)	O	O	R+*	R
>>Retrieve AE Title	(0008,0054)	O	O	O	R
>>>Storage Media File-Set ID	(0088,0130)	O	O	O	O
>>>Storage Media File-Set UID	(0088,0140)	O	O	O	O
>>>Referenced SOP Sequence	(0008,1199)				
>>>>Referenced SOP Class UID	(0008,1150)	O	O	R+*	R
>>>>Referenced SOP Instance UID	(0008,1155)	O	O	R+*	R
Relevant Information Sequence	(0040,4022)				
>Study Instance UID	(0020,000D)	O	O	O	R
>Referenced Series Sequence	(0008,1115)				
>>Series Instance UID	(0020,000E)	O	O	O	R
>>Retrieve AE Title	(0008,0054)	O	O	O	O
>>>Storage Media File-Set ID	(0088,0130)	O	O	O	O
>>>Storage Media File-Set UID	(0088,0140)	O	O	O	R
>>>Referenced SOP Sequence	(0008,1199)				
>>>>Referenced SOP Class UID	(0008,1150)	O	O	O	R
>>>>Referenced SOP Instance UID	(0008,1155)	O	O	O	R

Attribute Name	Tag	Query Keys Matching		Query Keys Return	
		SCU	SCP	SCU	SCP
Resulting General Purpose Performed Procedure Step Sequence	(0040,4015)				
>Referenced SOP Class UID	(0008,1150)	O	O	O	R
>Referenced SOP Instance UID	(0008,1155)	O	O	O	R
Actual Human Performers Sequence	(0040,4035)				
>Human Performer Code Sequence	(0040,4009)	O	O	O	R
>>Code Value	(0008,0100)	O	O	O	R
>>Coding Scheme Designator	(0008,0102)	O	O	O	R
>>Code Meaning	(0008,0104)	-	-	O	R
>Human Performer's Name	(0040,4037)	O	O	O	R+
>Human Performer's Organization	(0040,4036)	O	O	O	R+
Study Instance UID	(0020,000D)	O	O	R+*	R
Multiple Copies Flag	(0040,4006)	O	O	O	R
All other Attributes from the General Purpose Scheduled Procedure Step Information Module		O	O	O	O
<b>General Purpose Scheduled Procedure Step Relationship</b>					
Referenced Request Sequence	(0040,A370)				
>Study Instance UID	(0020,000D)	O	O	R+*	R
>Referenced Study Sequence	(0008,1110)				
>>Referenced SOP Class UID	(0008,1150)	O	O	R+*	R
>>Referenced SOP Instance UID	(0008,1155)	O	O	R+*	R
>Requested Procedure ID	(0040,1001)	R+	R+	R+	R
>Requested Procedure Description	(0032,1060)	O	O	O	R
>Requested Procedure Code Sequence	(0032,1064)				
>>Code Value	(0008,0100)	O	O	O	R
>>Coding Scheme Designator	(0008,0102)	O	O	O	R
>>Code Meaning	(0008,0104)	-	-	O	R
>Accession Number	(0008,0050)	R+	R	R+	R
>Requesting Physician	(0032,1032)	O	O	O	R
>All other Attributes relating to the Requested Procedure and the Imaging Service Request in the General Purpose Scheduled Procedure Step Relationship Module		O	O	O	O

Attribute Name	Tag	Query Keys Matching		Query Keys Return	
		SCU	SCP	SCU	SCP
<b>Patient Relationship</b>					
All Attributes from the Patient Relationship Module		O	O	O	O
<b>Patient Identification</b>					
Patient's Name	(0010,0010)	R+	R	R+	R
Patient ID	(0010,0020)	R+	R	R+	R
All other Attributes from the Patient Identification Module		O	O	O	O
<b>Patient Demographic</b>					
Patient's Birth Date	(0010,0030)	O	O	R+	R
Patient's Sex	(0010,0040)	O	O	R+	R
All other Attributes from the Patient Demographic Module		O	O	O	O
<b>Patient Medical</b>					
All Attributes from the Patient Medical Module		O	O	O	O

**4.37.4.1.3 Expected Actions**

The Post-Processing Manager performs the query and sends the matching General Purpose Worklist items to the Evidence Creator.

8885 **4.37.4.2 Receive General Purpose Worklist Message**

This is the message the Post-Processing Manager sends containing post-processing General Purpose Worklist information as a response to the Evidence Creator query.

**4.37.4.2.1 Trigger Events**

The Post-Processing Manager receives a query for a Post-Processing Worklist.

8890 **4.37.4.2.2 Message Semantics**

C-FIND Response from the DICOM General Purpose Worklist SOP Class will be used for this message. Some of the attributes queried through the worklist originate from other sources during previous steps in the workflow, and are made available to the Post-Processing Manager (grouped with Department System Scheduler or Image Manager) through other transactions such as MPPS. It is up to the Post-Processing Manager to determine the Input Information, e.g., study, series, etc. appropriate to be used in a workitem Scheduled Procedure Step, i.e., it is independent of the acquisition process and resulting MPPS.

8895 The Post-Processing Manager shall specify the type of task to be performed in the content of the Scheduled Workitem Code Sequence (0040,4018) using one of the following values from DCMR [CID 9231](#):  
8900



**Table 4.37-5: Post-Processing Workitem Definition**

<b>Coding Scheme Designator (0008,0102)</b>	<b>Code Value (0008,0100)</b>	<b>Code Meaning (0008,0104)</b>
DCM	110001	Image Processing
DCM	110002	Quality Control
DCM	110003	Computer Aided Diagnosis
DCM	110004	Computer Aided Detection
DCM	110008	Print
DCM	110009	No subsequent Workitems

#### 4.37.4.2.3 Expected Actions

An automated Evidence Creator uses the worklist to start post-processing or the user is provided with the worklist to start work.

### 8905 4.38 Workitem Claimed [RAD-38]

#### 4.38.1 Scope

8910 Upon selecting a post-processing workitem, the Evidence Creator takes ownership of the item by telling the Post Processing Manager to change the status of the SPS to IN PROGRESS. This allows the Post-Processing Manager to update its worklist and permits other worklist users to detect that this SPS has been claimed and is possibly already being worked on.

Similarly, during the reporting workflow, upon selecting a Reporting workitem, the Report Creator takes ownership of the item by telling the Reporting Manager to change the status of the SPS to IN PROGRESS. This allows the Report Manager to update its worklist and permits other worklist users to detect that this SPS has been claimed and is possibly already being worked on.

8915 In both workflow cases, the SCU can also set the status to SUSPEND.

#### 4.38.2 Actor Roles

**Actor:** Evidence Creator

**Role:** Updates the Post-Processing Manager of the new status of the post-processing SPS when the Evidence Creator claims the post-processing SPS.

8920 **Actor:** Post-Processing Manager

**Role:** Accepts post-processing GP-SPS update information from the Evidence Creator.

**Actor:** Report Creator

**Role:** Updates Report Manager with status of the Reporting SPS when the Report Creator claims the reporting SPS.

8925 **Actor:** Report Manager

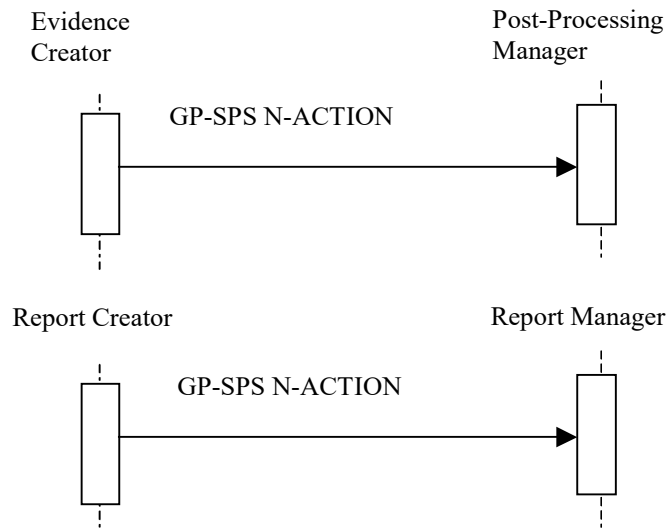
**Role:** Accepts GP-SPS update information from the Report Creator.

### 4.38.3 Referenced Standards

DICOM PS3.4: General Purpose Scheduled Procedure Step SOP Class.

### 4.38.4 Messages

8930



**Figure 4.38.4-1: Interaction Diagram**

#### 4.38.4.1 General Purpose Scheduled Procedure Step In Progress/Suspend Message

8935 **4.38.4.1.1 Trigger Events**

For a post-processing workitem, a user or an automated function on the Evidence Creator begins to act on a post-processing scheduled procedure step, or stops acting on it without completing it.

For the reporting workitem, the user begins to act on the scheduled procedure step at the Report Creator, or stops acting on it without completing it.

8940 **4.38.4.1.2 Message Semantics**

The Evidence Creator uses the N-ACTION request of the DICOM General Purpose Scheduled Procedure Step SOP Class to inform the Post-Processing Manager that a specific SPS has been started, and its status is IN PROGRESS. The Evidence Creator performs the SCU role, and the Post-Processing Manager performs the SCP role. An SPS may also be suspended or resumed, and the associated status of SUSPENDED or SCHEDULED will be set (see the DICOM PS3.4 Section F.1.6 for additional information).

8945 The Report Creator and Report Manager utilize the same mechanism, where the Report Creator performs the SCU role, and the Report Manager performs the SCP role.

8950 If a human is performing the Post-Processing scheduled procedure step, then the N-ACTION request may include the Actual Human Performers Sequence.

In a case of the reporting scheduled procedure step, the Report Creator shall send the Actual Human Performer Sequence to the Reporting Manager, who shall then check if the person is allowed to perform the workitem. The Report Creator application shall ensure that the correct user information is filled in the sequence.

#### 8955 **4.38.4.1.3 Expected Actions**

The Post-Processing Manager updates the status of the SPS to IN PROGRESS, which is an indication that the SPS is already being working on, and other Evidence Creators shall not perform any action on it. Attempts by any Evidence Creator without the current Transaction UID to update the SPS will be rejected.

8960 When Post-Processing Manager updates the status of the SPS to SUSPENDED or SCHEDULED, the SPS has now been released from the control of the Evidence Creator.

In the same way, the Report Manager updates the status of the SPS to IN PROGRESS, which is an indication that the SPS is already being working on, and other Report Creators shall not perform any action on it. Attempts by any other Report Creator to update the SPS will be rejected by the Report Manager.

8965

When the Report Manager updates the status of the SPS to SUSPENDED or SCHEDULED, the SPS has now been released from the control of the Report Creator.

### **4.39 Workitem Performed Procedure Step In Progress [RAD-39]**

#### **4.39.1 Scope**

8970 Upon starting to work on the claimed post-processing scheduled procedure step, Evidence Creator sends a message to the Post-Processing Manager to create a Performed Procedure Step (PPS).

Upon starting to work on the claimed reporting scheduled procedure step, Report Creator sends a message to the Report Manager to create a Performed Procedure Step (PPS).

#### 8975 **4.39.2 Actor Roles**

**Actor:** Evidence Creator

**Role:** Update the Post-Processing Manager with creation of a post-processing PPS when the **Evidence** Creator starts the work.

**Actor:** Report Manager

8980 **Role:** Accept PPS information from Report Creator.

**Actor:** Report Creator

**Role:** Updates the Report Manager with the creation of a Reporting Workitem PPS, when the Report Creator starts the work.

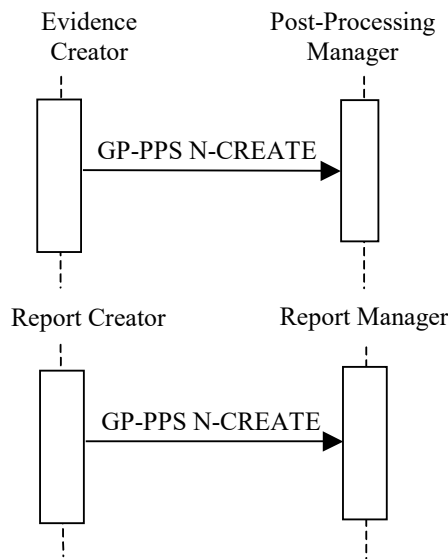
**Actor:** Post-Processing Manager

8985 **Role:** Accept post-processing PPS information from the Evidence Creator.

### 4.39.3 Referenced Standards

DICOM PS3.4: General Purpose Performed Procedure Step SOP Class

### 4.39.4 Messages



8990

**Figure 4.39.4-1: Interaction Diagrams**

#### 4.39.4.1 General Purpose Performed Procedure Step In Progress Message

##### 4.39.4.1.1 Trigger Events

8995 For a post-processing workitem, a user or an automated function on the Evidence Creator begins a post-processing performed procedure step.

For a reporting workitem, a user begins to perform the scheduled procedure step at the Report Creator.

##### 4.39.4.1.2 Message Semantics

9000 The Evidence Creator as SCU uses the N-CREATE request of the DICOM General Purpose Performed Procedure Step SOP to inform the Post-Processing Manager as SCP that a specific PPS has been started and its status is IN PROGRESS.

##### 4.39.4.1.3 Expected Actions

The Post-Processing Manager or the Report Manager creates the PPS with status IN PROGRESS.

9005 If a Referenced General Purpose Scheduled Procedure Step Sequence (0040,4016) item is present in the N-CREATE request, the Post-Processing Manager or the Report Manager shall update the Attribute Resulting General Purpose Performed Procedure Steps Sequence (0040,4015) in the identified General Purpose Scheduled Procedure Step SOP Instance.

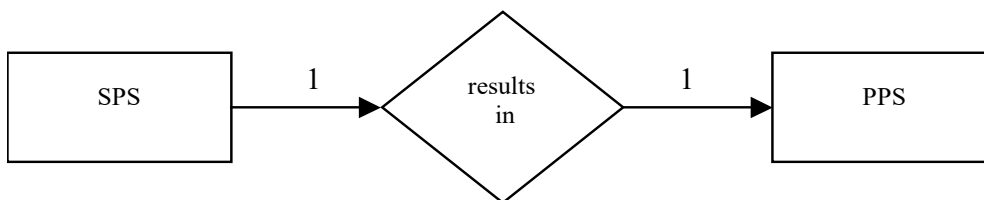
9010 The Post-Processing Manager may use the Performed Work Status Update transaction to notify the interested recipients about the received GP-PPS.

The Report Manager may use the Performed Work Status Update transaction to notify the interested recipients about the received GP-PPS using for this purpose.

#### 4.39.4.1.3.1 Relationship between Scheduled and Performed Procedure Steps

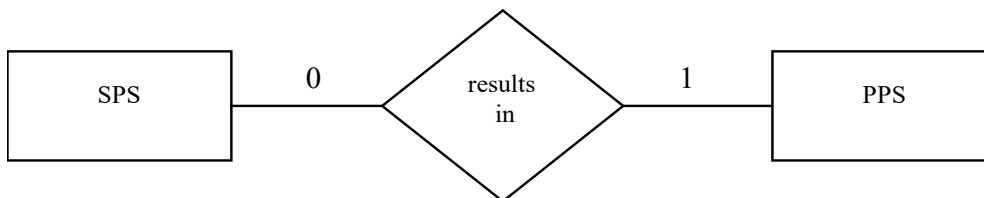
9015 The relationship between Scheduled and Performed Procedure Step information is shown in the following cases. Refer to RAD TF-2x: Appendix C for details of forming attributes in each of these cases.

##### 4.39.4.1.3.1.1 Simple Case



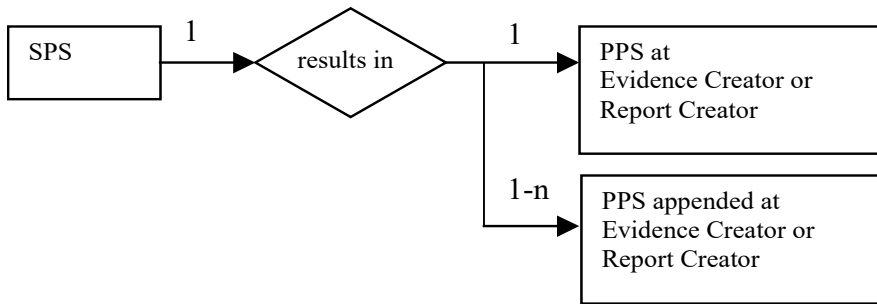
9020 This case indicates a 1-to-1 relationship between SPS and PPS. Information about the Scheduled Procedure Step and Requested Procedure shall be copied from the Scheduled Procedure Step object to the Performed Procedure Step Relationship Module.

##### 4.39.4.1.3.1.2 Unscheduled Case



9025 This case indicates a 0-to-1 relationship between SPS and PPS. Information about the Scheduled Procedure Step and, possibly, Requested Procedure is not available to the Evidence Creator or Report Creator due to different reasons, e.g., General Purpose Worklist SCP not available, unplanned post-processing during reporting.

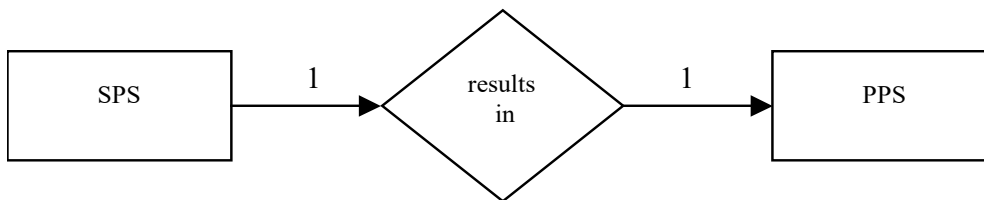
**4.39.4.1.3.1.3 Append Case**



9030 This case indicates a 1-to-N relationship between SPS and PPS where first the PPS is generated in response to an SPS. Other Performed Procedure Steps are added sequentially at a later time. All Performed Procedure Steps shall refer back to the same Requested Procedure and to the original SPS. All Requested Procedure and Scheduled Procedure Step attributes shall be copied from the Scheduled Procedure Step Object to the Performed Procedure Step Relationship Module and to the Request Attribute Sequence of the resulting composite instance.

9035 No PPS can be appended if the SPS status is COMPLETED or DISCONTINUED.

**4.39.4.1.3.1.4 Abandoned Case**



9040 This case indicates a 1-to-1 relationship between SPS and PPS, even though the PPS may or may not have associated Evidence Documents Images or other data objects. A procedure step may have to be abandoned for clinical reasons before it is complete. If SOP instances are sent by the Evidence Creator to the Image Archive or from the Report Creator to Report Manager, then they shall be identified in the PPS N-SET. This is a means to explicitly communicate this information to the Post-Processing Manager. All Requested Procedure and Scheduled Procedure Step attributes shall be copied from the Scheduled Procedure Step Object to the Performed Procedure Step Relationship Module.

9045

**4.40 Workitem Performed Procedure Step Completed [RAD-40]**

**4.40.1 Scope**

9050 After completing or discontinuing a post-processing performed procedure step, the Evidence Creator sends a message to the Post-Processing Manager to update the PPS status to COMPLETED or DISCONTINUED and references any results that have been created and sent to the Image Manager/Archive.

9055 Report Creator behaves similarly to update the Report Manager with the PPS status and the references to the result that was created and sent to the Report Manager, e.g., an SR object, or an external ID of an object outside of IHE scope.

#### 4.40.2 Actor Roles

**Actor:** Evidence Creator

**Role:** Update the Post-Processing Manager with status of the post-processing PPS when the Evidence Creator finishes or discontinues work.

9060 **Actor:** Post-Processing Manager

**Role:** Accept post-processing PPS information from the Evidence Creator.

**Actor:** Report Creator

**Role:** Updates Report Manager with status of the Reporting Workitem PPS, when it finishes or discontinues work.

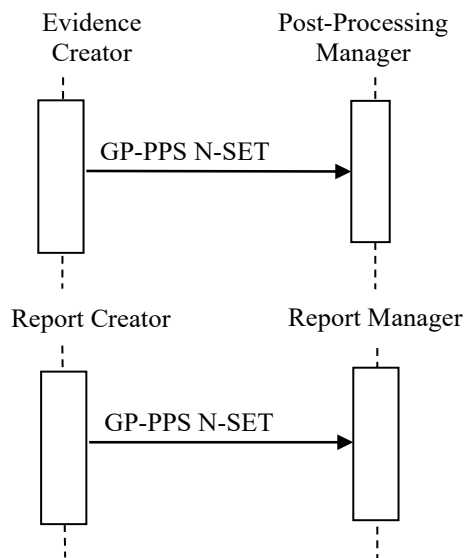
9065 **Actor:** Report Manager

**Role:** Accepts PPS information from Report Creator.

#### 4.40.3 Referenced Standards

DICOM PS3.4: General Purpose Performed Procedure Step SOP Class

#### 4.40.4 Messages



**Figure 4.40.4-1: Interaction Diagrams**

#### **4.40.4.1 General Purpose Performed Procedure Step Completed Message**

##### **4.40.4.1.1 Trigger Events**

9075 For a post-processing workitem, automated Evidence Creator, or a user finishes the post-processing scheduled procedure step.

For a reporting Workitem, a user finishes the work on the scheduled procedure step.

##### **4.40.4.1.2 Message Semantics**

9080 The Evidence Creator as SCU uses the N-SET request of the DICOM General Purpose Performed Procedure Step SOP Class to inform the Post-Processing Manager as SCP that a specific performed procedure step has been done and its status is COMPLETED. The Evidence Creator may use N-SET to send intermediate updates of the PPS information. The final N-SET has either the status of COMPLETED or DISCONTINUED. The Report Manager acts in the same way as SCU with the Report Manager as SCP. The Report Manager notifies the DSS about the PPS status through either the Performed Work Status Update or by grouping with it.

9085 When the status is set to COMPLETED or DISCONTINUED, the Evidence Creator shall send to the Post-Processing Manager a list of all Composite SOP Instances, if any, created in the Output Information Sequence (0040,4033). Similarly, the Report Creator shall send the list of all SOP Instances in the Output Information Sequence (0040,4033) or identify non-DICOM output in the Non-DICOM Output Code Sequence (0040,4032).

##### **4.40.4.1.3 Reporting Message Semantics**

9090 After the workitem has been completed, the Report Creator shall provide the Report Manager with the details of the reporting task that has been performed. This information shall be included into the Performed Work Item Code Sequence in the General Purpose Performed Procedure Step N-SET message. The Report Creator shall also reference any results created during the reporting task performed. The output information is part of the General Purpose Performed Procedure Step Results Module. The output data must be stored to an appropriate data repository. Which data repository is used will depend on the type of the output data that might be a report, an audio file, an Evidence Document or other objects.

9100 The Report Creator may also suggest subsequent work items to the Report Manager. The requested subsequent work items are included in the General Purpose Performed Procedure Step Results Module.

##### **4.40.4.1.4 Expected Actions**

The Post-Processing Manager or Report Manager updates the status of the PPS to COMPLETED or DISCONTINUED.



9105 **4.41 Workitem Completed [RAD-41]**

**4.41.1 Scope**

9110 After completing or discontinuing a post-processing scheduled procedure step, the Evidence Creator sends a message to the Post-Processing Manager to update the SPS status to COMPLETED or DISCONTINUED. This allows the Post-Processing Manager to update its worklist.

After completing or discontinuing a reporting scheduled procedure step, the Report Creator sends a message to the Report Manager to update the SPS status to COMPLETED or DISCONTINUED. This allows the Report Manager to update its worklist.

**4.41.2 Actor Roles**

9115 **Actor:** Evidence Creator

**Role:** Update the Post-Processing Manager with status of the post-processing SPS when the Evidence Creator finishes work.

**Actor:** Post-Processing Manager

**Role:** Accept post-processing GP-SPS information from Evidence Creator.

9120 **Actor:** Report Creator

**Role:** Updates Report Manager with status of the Reporting Workitem SPS, when it finishes the work.

**Actor:** Report Manager

**Role:** Accepts reporting GP-SPS information from Report Creator.

9125 **4.41.3 Referenced Standards**

DICOM PS3.4: General Purpose Scheduled Procedure Step SOP Class

**4.41.4 Messages**

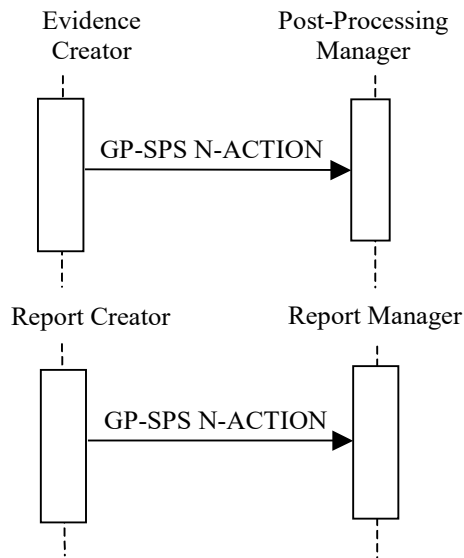


Figure 4.41.4-1: Interaction Diagrams

9130

#### 4.41.4.1 General Purpose SPS Completed Message

##### 4.41.4.1.1 Trigger Events

For a post-processing workitem, a user or automated function on the Evidence Creator finishes the post-processing scheduled procedure step.

9135 For the reporting workitem, a user finishes the work on the scheduled procedure step at the Report Creator.

##### 4.41.4.1.2 Message Semantics

9140 The Evidence Creator as SCU uses the N-ACTION request of the DICOM General Purpose Scheduled Procedure Step SOP Class to inform the Post-Processing Manager as SCP that a specific scheduled procedure step has been finished and its status is COMPLETED. This message informs the Post-Processing Manager that the SPS is complete and that further PPS will not be created for this SPS. The Evidence Creator may also discontinue a SPS with a status of DISCONTINUED.

9145 In the same way, the Report Creator uses the N-ACTION request of the DICOM General Purpose Scheduled Procedure Step SOP Class to inform the Report Manager as SCP that a specific scheduled procedure step has been finished and its status is COMPLETED. This message informs the Report Manager that the workitem SPS is complete and that further PPS will not be created for this SPS. The Report Creator may also discontinue a SPS with a status of DISCONTINUED.

##### 9150 4.41.4.1.3 Expected Actions

The Post-Processing Manager or the Report Manager updates the status of the SPS to COMPLETED or DISCONTINUED.

In addition, the Post-Processing Manager or Report Manager informs the DSS and Image Manager using the Performed Work Status Update transaction.

9155 **4.42 Performed Work Status Update [RAD-42]**

**4.42.1 Scope**

This transaction is used by the Department System Scheduler, Report Manager or the Image Manager to inform the others of the status of performed work being managed. This transaction allows the system not managing the performed work to stay in sync with the status.

9160 How or whether the non-managing system uses this information is at the discretion of implementers and customers. Some examples are given below:

- The Department System Scheduler is grouped with the Post-Processing Manager and manages all post-processing tasks. This transaction enables the Department System Scheduler to notify the Image Manager about the Post-Processing work that has been performed, e.g., CAD has been performed on a set of images and an evidence document has been stored.
- The Image Manager is grouped with the Post-Processing Manager and manages some post-processing tasks. This transaction enables the Image Manager to notify the Department System Scheduler about the post-processing work that has been performed.
- The Report Manager is implemented as a standalone system and manages reporting tasks. This transaction enables Report Manager to notify Department System Scheduler and Image Manager that report has been completed.

**4.42.2 Actor Roles**

**Actor:** Department System Scheduler

9175 **Role:** When managing tasks (i.e., is grouped with a Post-processing Manager), it must send task status notifications to the Image Manager and Report Manager. When monitoring the status of tasks managed by the Image Manager or Report Manager it must be ready to receive task status notifications.

**Actor:** Image Manager

9180 **Role:** When managing tasks (i.e., is grouped with a Post-processing Manager), it must send task status notifications to the Department System Scheduler and Report Manager. When monitoring the status of tasks managed by the Department System Scheduler or Report Manager it must be ready to receive task status notifications.

**Actor:** Report Manager

9185 **Role:** When managing tasks (i.e., implementing Reporting Worklist, Workitem Claimed, Workitem Completed, Workitem Performed Procedure Step In Progress, Workitem Performed Procedure Step Completed), it must send task status notifications to the Department System

Scheduler and Image Manager. When monitoring the status of tasks managed by the Department System Scheduler or Image Manager it must be ready to receive task status notifications.

9190 **4.42.3 Referenced Standards**

DICOM PS3.4: General Purpose Performed Procedure Step SOP Class

4.42.4 Messages

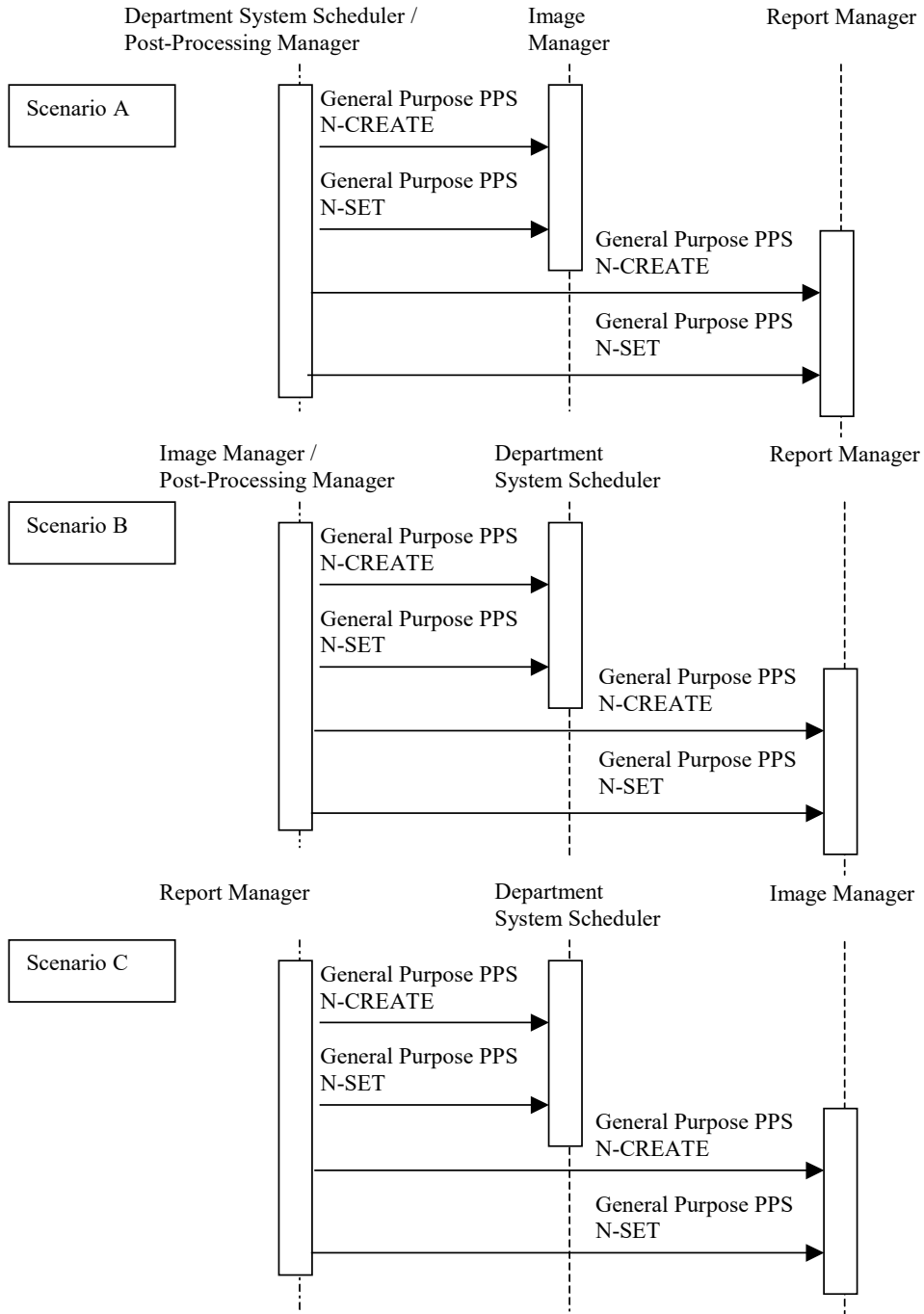


Figure 4.42.4-1: Interaction Diagrams

9195 **4.42.4.1 Post-Processing Performed Procedure Step Created/Updated Message**

**4.42.4.1.1 Trigger Events**

9200 In scenario A, the Department System Scheduler is grouped with a Post-Processing Manager and receives status creation or update on tasks it manages. In scenario B, the Image Manager, due to being grouped with a Post-Processing Manager, receives status creation or updates on tasks it manages, e.g., from an Evidence Creator. In Scenario C, Report Manager receives status creation or updates on tasks it manages from Report Creator. In either scenario, for example, a GP-PPS Completed message received by the Post-Processing Manager or Report Manager shall trigger the Work Status Update message to be sent.

9205 **4.42.4.1.2 Message Semantics**

9210 In scenario A, the Department System Scheduler uses the N-CREATE and N-SET requests of the DICOM General Purpose Performed Procedure Step SOP to inform the Image Manager and Report Manager when work has been started and when it is complete. The Department System Scheduler performs the SCU role, and the Image Manager and Report Manager perform the SCP role.

9215 In scenario B, the Image Manager uses the N-CREATE and N-SET requests of the DICOM General Purpose Performed Procedure Step SOP to inform the Department System Scheduler and Report Manager when work has been started and when it is complete. The Image Manager performs the SCU role, and the Department System Scheduler and Report Manager perform the SCP role.

9220 In scenario C, the Report Manager uses the N-CREATE and N-SET requests of the DICOM General Purpose Performed Procedure Step SOP to inform the Department System Scheduler and Image Manager when work has been started and when it is complete. The Report Manager performs the SCU role, and the Department System Scheduler and Image Manager performs the SCP role.

9225 “Performed work” may consist of one or more related sub-workitems managed by the SCU, who is acting as the workflow manager for these workitems. As the SCU receives status information about each sub-workitem, it will in turn update the SCP. The SCU sends N-CREATE with GP-PPS status of “IN PROGRESS” after the sub-workitem has been claimed, but no later than the first workitem performed procedure step in progress transaction for that sub-workitem has been performed. In the N-CREATE, the SCU uses the Performed Workitem Code Sequence (0040,4019) to communicate the sub-workitem. The SCU may use N-SET to send intermediate updates. The final N-SET with GP-PPS status of “COMPLETED” is sent after the sub-workitem GP-SPS is completed. If there are further sub-workitems managed by the SCU, N-SET will

9230 contain the Requested Subsequent WorkItem Code Sequence, indicating the next workitem it will be updating. When the SCU finishes updating all sub-workitems it manages, this attribute will be sent with the workitem of “No Subsequent Workitems,” signifying the end of this set of performed work. This means that another workflow manager may take over managing subsequent set of work.

9235 Post-Processing Manager and Report Manager shall generate unscheduled GP-PPS to use in the Performed Work Status transaction; they cannot simply re-transmit the GP-PPS received from the Evidence Creator or Report Creator. To populate Performed WorkItem Code Sequence, they shall use appropriate codes from DCMR Context Group 9231 (see Table 4.42-1).

**Table 4.42-1: Context ID 9231 – General Purpose Workitem Definition**

<b>Coding Scheme Designator (0008,0102)</b>	<b>Code Value (0008,0100)</b>	<b>Code Meaning (0008,0104)</b>
DCM	110001	Image Processing
DCM	110002	Quality Control
DCM	110003	Computer Aided Diagnosis
DCM	110004	Computer Aided Detection
DCM	110005	Interpretation
DCM	110006	Transcription
DCM	110007	Report Verification
DCM	110008	Print
DCM	110009	No subsequent Workitems

9240 **4.42.4.1.3 Expected Actions**

The Department System Scheduler or Image Manager records and uses the information as appropriate to its responsibilities.

**4.43 Evidence Document Stored [RAD-43]**

**4.43.1 Scope**

9245 In the Evidence Documents Stored transaction, the Acquisition Modality or the Evidence Creator transmits an Evidence Document, which is stored in the Image Archive.

Evidence Documents are DICOM composite objects that are produced as a result of performing procedure steps such as image acquisition, image processing or computer-aided detection.

9250 These objects are intended to serve as evidence for diagnostic interpretation; however, they are not images but rather DICOM Structured Reporting documents. Evidence Documents represent the uninterpreted information which is primarily managed and used inside imaging department, although distribution outside Radiology is not precluded. Such objects are not expected to be managed by the Report Manager. Objects encoded as SOP Instances of such SOP classes as Mammography CAD are examples of Evidence documents.

9255 **4.43.2 Actor Roles**

**Actor:** Acquisition Modality

**Role:** Records non-imaging evidence information in the Evidence Documents and stores them to the Image Archive.

**Actor:** Evidence Creator

9260 **Role:** Records non-imaging evidence information in the Evidence Documents and stores them to the Image Archive.

**Actor:** Image Archive

**Role:** Accepts and Stores Evidence Document Instances received from the Acquisition Modality or Evidence Creator.

9265 **4.43.3 Referenced Standards**

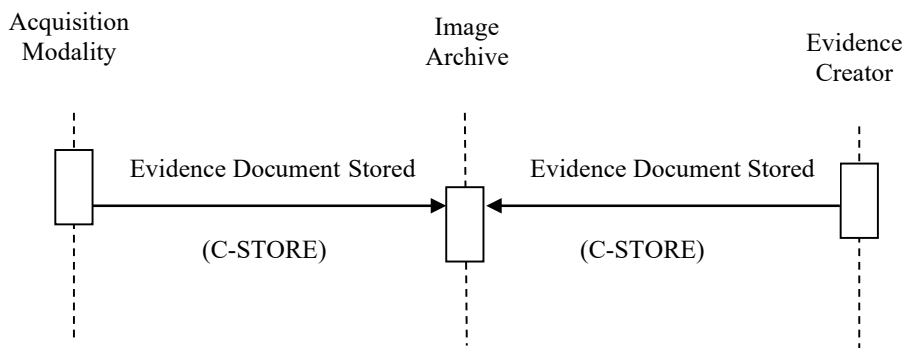
DICOM [PS3.4 Annex B](#): Storage Service Class

DICOM [PS3.3](#): Information Object Definitions -

9270 Basic Text SR SOP Class; Enhanced SR SOP Class; Comprehensive SR SOP Class; Chest CAD SR SOP Class; Mammography CAD SR SOP Class; OB-GYN Ultrasound Procedure Reports; Catheterization Lab SR; Vascular Ultrasound SR.

Note: This list is intended to provide a base list of examples. It is expected that DICOM will continue to publish additional SR SOP Classes and Templates appropriate for Evidence Documents.

**4.43.4 Messages**



9275 **Figure 4.43.4-1: Interaction Diagram**

**4.43.4.1 Evidence Document Stored**

This transaction relates to the “DICOM C-STORE” event between the Acquisition modality or the Evidence Creator and the Image Archive in the above interaction diagram.

**4.43.4.1.1 Trigger Events**

9280 The Acquisition Modality or the Evidence Creator generates Evidence Documents that need to be archived.

**4.43.4.1.2 Message Semantics**

The Acquisition Modality or the Evidence Creator uses the DICOM C-STORE message to transfer the Evidence Documents (as SR objects) to the Image Archive for storage. The



9285 Acquisition Modality or the Evidence Creator is the DICOM Storage SCU and the Image Archive is the DICOM Storage SCP.

It is a requirement that certain information be recorded in the Evidence Document header. The details of mapping such information to DICOM SOP instances are specified in RAD TF-2x: Appendix A.2, Table A.2-1.

9290 **4.43.4.1.3 Expected Actions**

The DICOM Standard defines a number of non-image storage SOP classes that may be used for creation of Evidence Documents. It is expected that the Image Archive will support multiple storage SOP classes as defined in Table 4.43-1 below.

**Table 4.43-1: Suggested Evidence Document SOP Classes**

SOP Class UID	SOP Class Name
1.2.840.10008.5.1.4.1.1.88.50	Mammography CAD SR
1.2.840.10008.5.1.4.1.1.88.11	Basic Text SR
1.2.840.10008.5.1.4.1.1.88.22	Enhanced SR
1.2.840.10008.5.1.4.1.1.88.33	Comprehensive SR
1.2.840.10008.5.1.4.1.1.88.65	Chest CAD SR

9295 It is also expected that the Image Archive will support one or more Templates that are defined to be used with the Evidence Documents, as specified in the Table 4.43-2.

**Table 4.43-2: Suggested Evidence Document Templates**

Template ID	Template Name
<a href="#">TID 4000</a>	Mammography CAD Document Root Template
<a href="#">TID 5000</a>	OB-GYN Ultrasound Procedure Report
<a href="#">TID 3500</a>	Hemodynamics Report
<a href="#">TID 4100</a>	Chest CAD SR Document Root Template
<a href="#">TID 5100</a>	Vascular Ultrasound Procedure Report Template

The Image Archive must support storage level 2: i.e., all type 3 attributes must be supported.

**4.43.4.1.3.1 Mammography Image Profile**

9300 Evidence Creator and Image Manager/Image Archive Actors supporting the Mammography Image Profile shall support the Mammography CAD SR SOP Class.

In particular, CAD systems (acting as Evidence Creators) performing analysis on Mammography images shall be able to return their results in Mammography CAD SR SOP Class instances. This does not preclude them from additionally creating Presentation States and/or Secondary Capture or Mammography images.

9305

Also, Image Manager/Image Archive Actors shall not only be able to receive Mammography CAD SR SOP Class objects from the Evidence Creator, but also be able to return them in

9310 response to queries (i.e., they must actually be stored intact for later retrieval, not merely processed or burned in to images dynamically). See Retrieve Evidence Documents [RAD-45] transaction, Section 4.45.4.2.3.1.

## 4.44 Query Evidence Documents [RAD-44]

### 4.44.1 Scope

This section describes the sequence of transactions required for the Image Display to query the Image Archive for instances of Evidence Documents.

### 9315 4.44.2 Actor Roles

**Actor:** Image Display

**Role:** Query for Evidence Documents objects (generally in order to retrieve them).

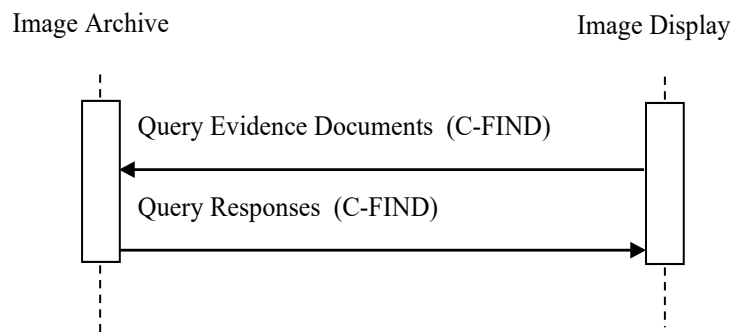
**Actor:** Image Archive

**Role:** Respond to queries from the Image Display for Evidence Documents objects.

### 9320 4.44.3 Referenced Standards

DICOM [PS3.4 Annex C](#): Query/Retrieve Service Class

### 4.44.4 Messages



**Figure 4.44.4-1: Interaction Diagram**

### 9325 4.44.4.1 Query Evidence Documents

The Query (Study Root – FIND and optionally Patient Root – FIND) SOP Classes shall be supported. Refer to DICOM [PS3.4 Annex C](#) Query/Retrieve Service Class for detailed descriptive semantics.

#### 4.44.4.1.1 Trigger Events

9330 Image Display needs to obtain information about Evidence Documents.

**4.44.4.1.2 Message Semantics**

The message semantics are defined by the DICOM Query/Retrieve SOP Classes.

9335 A C-FIND Request from the DICOM Study Root Query/Retrieve Information Model – FIND SOP Class or the DICOM Patient Root Query/Retrieve Information Model – FIND SOP Class shall be sent from the Image Display to the Image Archive.

The Image Display uses one or more matching keys as filter criteria to obtain the list of matching entries in the Image Archive at the selected level (Patient & Study/Series/Instance).

9340 In addition to the required and unique keys defined by the DICOM Standard, the IHE Radiology Technical Framework has defined matching and return keys to be supported by query SCUs and SCPs. The keys are defined in Section 4.14.4.1.2 and Table 4.14-1. The conventions for key usage are defined in Section 2.2. For the Image Display (SCU) and the Image Archive (SCP) the additional Evidence Document Instances specific keys are defined in Table 4.44-1.

**Table 4.44-1: Evidence Document Instance Specific Query Matching and Return Keys**

Attribute Name	Tag	Query Keys Matching		Query Keys Return	
		SCU	SCP	SCU	SCP
<b>Evidence Document Instance Specific Level</b>					
Content Date	(0008,0023)	O	O	O	R+
Content Time	(0008,0033)	O	O	O	R+
Referenced Request Sequence	(0040,A370)				
>Study Instance UID	(0020,000D)	O	O	R+*	R+
>Accession Number	(0008,0050)	O	O	R+	R+
>Requested Procedure ID	(0040,1001)	O	O	R+	R+
>Requested Procedure Code Sequence	(0032,1064)				
>>Code Value	(0008,0100)	O	O	O	R+
>>Coding Scheme Designator	(0008,0102)	O	O	O	R+
>>Coding Scheme Version	(0008,0103)	O	O	O	R+
>>Code Meaning	(0008,0104)	O	O	O	R+
Content Template Sequence	(0040,A504)				
>Template Identifier	(0040,DB00)	O	O	R+	R+
Concept Name Code Sequence	(0040,A043)				
>Code Value	(0008,0100)	O	O	R+*	R+
>Coding Scheme Designator	(0008,0102)	O	O	R+*	R+
>Coding Scheme Version	(0008,0103)	O	O	O	R+
>Code Meaning	(0008,0104)	O	O	R+	R+

**4.44.4.1.3 Expected Actions**

9345 The Image Archive receives the C-FIND request, performs the matching on the provided keys and sends the list of matching records back to the Image Display via C-FIND responses.

The Image Display is expected to use the Template ID to select Evidence Documents for retrieval that it supports.

#### **4.44.4.1.3.1 Mammography Image Profile**

9350 Image Display and Image Manager/Image Archive Actors supporting the Mammography Image Profile shall support the Mammography CAD SR SOP Class.

### **4.45 Retrieve Evidence Documents [RAD-45]**

#### **4.45.1 Scope**

9355 In the Retrieve Evidence Documents Transaction, the requested DICOM Evidence Documents are transferred from the Image Archive to the Image Display or from the Imaging Document Source to the Imaging Document Consumer.

#### **4.45.2 Actor Roles**

**Actor:** Image Archive:

**Role:** Sends requested Evidence Documents to the Image Display.

9360 **Actor:** Imaging Document Source

**Role:** Sends requested Evidence Documents to the Imaging Document Consumer.

**Actor:** Image Display

**Role:** Receives requested Evidence Documents from the Image Archive.

**Actor:** Imaging Document Consumer

9365 **Role:** Receives requested Evidence Documents from the Imaging Document Source

#### **4.45.3 Referenced Standards**

DICOM [PS3.4 Annex C](#): Query/Retrieve Service Class

#### 4.45.4 Messages

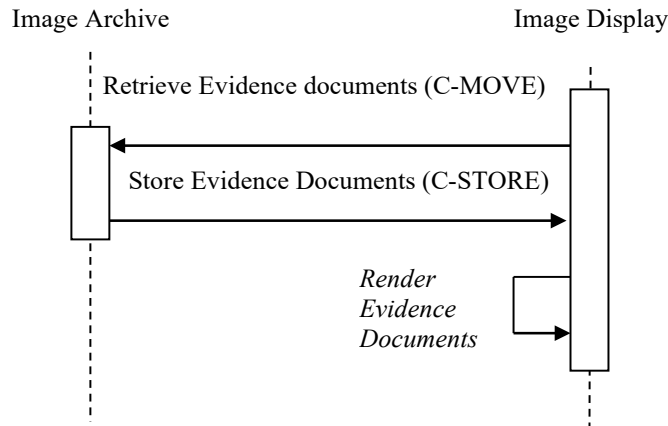


Figure 4.45.4-1: Interaction Diagram

9370

#### 4.45.4.1 Retrieve Evidence Documents

The Retrieve (Study Root – MOVE and optionally Patient Root – MOVE) SOP Classes shall be supported. The Image Archive as an SCU shall support DICOM Storage SOP Classes that may be used as Evidence Documents. The Imaging Document Source as an SCU shall support DICOM Storage SOP Classes that may be used as Evidence Documents it published for sharing. Refer to DICOM [PS3.4 Annex C](#) for detailed descriptive semantics (see Table 4.38-1).

9375

In the case of retrieving Evidence Documents in a Cross-Enterprise, imaging document sharing (XDS-I.b) network environment, a configuration of mapping the AE Titles to DICOM AE Network Addresses (IP Address and Port number) needs to be exchanged between the Imaging Document Source and the Imaging Document Consumer. RAD TF-2x: Appendix G describes in detail the AE Title mapping to the DICOM AE Network Addresses.

9380

##### 4.45.4.1.1 Trigger Events

The Image Display or the Imaging Document Consumer selects specific Evidence Document objects to retrieve from the Image Archive or the Imaging Document Source.

9385

##### 4.45.4.1.2 Message Semantics

The message semantics are defined in DICOM [PS3.4 Annex C](#) Query/Retrieve Service Class. It is the responsibility of the Image Manager or Imaging Document Source to assure that the patient and procedure information is current in the Evidence Document objects when they are retrieved from the Image Archive or Imaging Document Source.

9390

##### 4.45.4.1.3 Expected Actions

The Image Archive or the Imaging Document Source receives the C-MOVE request, establishes a DICOM association with the Image Display or the Imaging Document Consumer, and uses the DICOM C-STORE command to transfer the requested Evidence Document objects.

9395 Since the Image Display or the Imaging Document Consumer can select compatible documents based on the Template IDs returned in the query, the Image Display or the Imaging Document Consumer is required not to return an error to the Image Archive or the Imaging Document Source due to the retrieved document content. The retrieved results may simply be discarded instead.

#### **4.45.4.2 Render Evidence Documents**

9400 This transaction relates to the “Render Evidence Documents” event of the above interaction diagram.

##### **4.45.4.2.1 Trigger Events**

The Image Display or the Imaging Document Consumer receives Evidence Document instances from the Image Archive or the Imaging Document Source.

##### **9405 4.45.4.2.2 Invocation Semantics**

This is a local invocation of functions resident within the Image Display or the Imaging Document Consumer. Evidence Documents shall be displayed to the user of the Image Display or the Imaging Document Consumer. The method used by the Image Display or the Imaging Document Consumer to present Evidence Documents for viewing by the user is outside the scope of the IHE Radiology Technical Framework. For example, in the case when an Image Display or an Imaging Document Source is grouped with an Evidence Creator, the Evidence Document may be rendered as input for further processing by the Evidence Creator.

##### **4.45.4.2.3 Expected Actions**

9415 The Image Display or the Imaging Document Consumer renders the Evidence Documents retrieved. If the Image Display or the Imaging Document Consumer is unable to handle parts of the document, it may inform the user and offer the choice of doing a “low-grade” rendering or ignoring the data.

9420 Evidence Documents may contain references to other types of evidence objects. The Image Display or the Imaging Document Consumer shall always be able to render (or “low-grade” render) referenced Evidence Documents or to invoke other rendering display functionality.

If the Image Display also supports the Consistent Presentation of Images Profile, it is also required to apply any presentation states referenced in the Evidence Document for application to the relevant images.

9425 If the Image Display also supports the Key Image Notes Profile, it is also required to render any Key Image Notes referenced in the Evidence Document.

Note: It is recommended to use the just retrieved instance of the Evidence Document to ensure that the most recent patient data be displayed to reflect possible patient merge and patient update in the Image Manager/Image Archive. This patient data may be inconsistent with patient data contained in a previously retrieved copy of the same Evidence Document instance.

9430 **4.45.4.2.3.1 Mammography Image Profile**

Image Display and Image Manager/Image Archive Actors supporting the Mammography Image Profile shall support the Mammography CAD SR SOP Class.

9435 Image Display Actors shall be able to apply Mammography CAD SR information to displayed images; see Section 4.16.4.2.2.1.1.8 Display of CAD Marks. It is not permitted to ignore data that has a rendering intent of presentation required; there is no such thing as a “low-grade” rendering for Mammography CAD SR.

## **4.46 Query Reporting Worklist [RAD-46]**

### **4.46.1 Scope**

9440 This transaction is used during Reporting work done by the Report Creator to find out what tasks have been scheduled or assigned to it by the Report Manager. This transaction allows the Report Manager to provide the Report Creator with a worklist that shall contain Reporting-related workitem codes for conducting Interpretation of Images, Dictation, Transcription and Verification of the report.

9445 The Report Manager is the provider of the worklist. It obtains the necessary information about the patient and type of a procedure through the Procedure Scheduled transaction from the Department System Scheduler. It is being notified about the existence of images and other evidence objects through the Modality Procedure Step completed transaction from Performed Procedure Step Manager, and may confirm their availability through the Images Available Query.

9450 The Report Creator retrieves the worklist and includes received information such as patient demographics, Study Instance UID, etc., in the resulting instances (see RAD TF-2x: Appendix D), which are stored through instance stored transactions such as Evidence Document Stored, Image Stored, etc.

### **4.46.2 Actor Roles**

9455 **Actor:** Report Creator

**Role:** Queries the Report Manager for Reporting Scheduled Procedure Steps.

**Actor:** Report Manager

9460 **Role:** Schedules Reporting procedure steps for the workitems of Interpretation, Dictation, Transcription and Verification as applicable; accepts query requests for Worklist items and returns responses.

### **4.46.3 Referenced Standards**

DICOM PS3.4: General Purpose Worklist SOP Class

#### 4.46.4 Messages

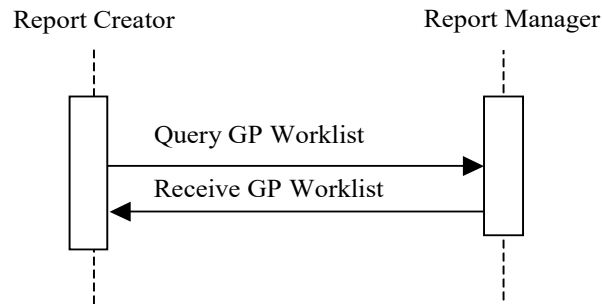


Figure 4.46.4-1: Interaction Diagram

9465

#### 4.46.4.1 Query General Purpose Worklist Message

This is the worklist query sent to the Report Manager.

##### 4.46.4.1.1 Trigger Events

9470

A user or an automated function on the Report Creator queries for scheduled Reporting worklist items.

##### 4.46.4.1.2 Message Semantics

C-FIND request of the DICOM General Purpose Worklist SOP Class is used to query for the general purpose worklist. Report Creator performs the SCU role, and the Report Manager performs the SCP role.

9475

##### 4.46.4.1.2.1 Matching Keys and Return Keys

The Report Creator is required to query for specific attributes (return keys) that will be inserted into the instances created as a result of creation of a diagnostic report. See Appendix D for more details.

9480

The Report Creator shall support individually each one of the required query keys listed in Table 4.46-3 – Return and Matching Keys For Reporting Worklist. In addition, at least one of the following two combinations shall be implemented by the Report Creator:

9485

1. **Patient Oriented Query:** Query for a worklist for a specific patient/procedure. The SCU shall support all combinations (31) of the matching key attributes listed in Table 4.46-1 by including 1 or more keys. The sequence attributes denoted in the italics are not matching keys on their own but have to be included in a query to convey the value of the attributes contained within them. Thus, the SCU shall support any combination of Patient's Name, Patient ID, Accession Number, Requested Procedure ID, and Scheduled Workitem Code.



**Table 4.46-1: GPWL Keys for Patient Oriented Query**

Matching Key Attributes	Tag
Patient's Name	(0010,0010)
Patient ID	(0010,0020)
<i>Referenced Request Sequence</i>	<i>(0040,A370)</i>
>Accession Number	(0008,0050)
>Requested Procedure ID	(0040,1001)
<i>Scheduled Workitem Code Sequence</i>	<i>(0040,4018)</i>
>Code Value	(0008,0100)
>Coding Scheme Designator	(0008,0102)

9490

2. **User-oriented Query:** Query for a broad worklist for particular user being logged in on a particular station. The SCU shall support all (63) combinations of the matching key attributes listed in Table 4.46-2 by including 1 or more keys. The sequence attributes denoted in the italics are not matching keys on their own but have to be included in a query to convey the value of the attributes contained within them. Code Value of the Scheduled Station Name Code Sequence, if valued, shall be set to the AE Title of the workstation's General Purpose Worklist SCU.

9495

**Table 4.46-2: GPWL Keys for User-Oriented Queries**

Matching Key Attributes	Tag
General Purpose Scheduled Procedure Step Status	(0040,4001)
<i>Scheduled Station Name Code Sequence</i>	<i>(0040,4025)</i>
>Code Value	(0008,0100)
>Coding Scheme Designator	(0008,0102)
Scheduled Procedure Step Start Date and Time	(0040,4005)
<i>Scheduled Workitem Code Sequence</i>	<i>(0040,4018)</i>
>Code Value	(0008,0100)
>Coding Scheme Designator	(0008,0102)
<i>Scheduled Human Performers Sequence</i>	<i>(0040,4034)</i>
> <i>Human Performer Code Sequence</i>	<i>(0040,4009)</i>
>>Code Value	(0008,0100)
>>Coding Scheme Designator	(0008,0102)
>Human Performer's Name	(0040,4037)

#### 4.46.4.1.2.2 Examples for the Use of Matching Key Attributes

9500

- Using the Scheduled Procedure Step Start Date and Time key: query for all the Reporting tasks scheduled for today.
- Using the Scheduled Workitem Code key: query for all Transcription tasks.

- Using Scheduled Human Performer Name key: query for all the Reporting tasks that are scheduled for this radiologist.
- 9505
- Using the Scheduled Procedure Step Start Date and Time, Scheduled Workitem Code and Scheduled Human Performer Name keys: query for all the report verification tasks that are scheduled for today on for this radiologist.

Note: Applications are recommended to append a wildcard “\*” at the end of each component of the structured Patient Name to facilitate matching with both structured and unstructured Patient Names.

9510 **4.46.4.1.2.3 Matching Keys and Return Keys**

The Report Creator is required to query for specific attributes (return keys), many of which will be required in the objects it creates. The requirements for the attributes in the stored objects are defined in RAD TF-2x: Appendix D. There are additional attributes that may be queried but might not be used elsewhere.

9515 Table 4.46-3 summarizes the matching key requirements and lists the optional and required attributes that may be requested and shall be returned in order to make these available to the user at the Report Creator. See Section 2.2 for more information on the requirements expressed in this table.

**Table 4.46-3: Matching and Return Keys for Report Worklist Queries**

Attribute Name	Tag	Query Keys Matching		Query Keys Return	
		SCU	SCP	SCU	SCP
<b>SOP Common</b>					
Specific Character Set	(0008,0005)	O	O	O	R
SOP Class UID	(0008,0016)	O	O	R+*	R
SOP Instance UID	(0008,0018)	O	R	R+*	R
<b>General Purpose Scheduled Procedure Step Information</b>					
General Purpose Scheduled Procedure Step Status	(0040,4001)	R+	R	R+	R
Input Availability Flag	(0040,4020)	O	R	R+	R
General Purpose Scheduled Procedure Step Priority	(0040,4003)	O	R	R+	R
Scheduled Procedure Step ID	(0040,0009)	O	O	O	R
Scheduled Workitem Code Sequence	(0040,4018)				
>Code Value	(0008,0100)	R+	R	R+*	R
>Coding Scheme Designator	(0008,0102)	R+	R	R+*	R
>Code Meaning	(0008,0104)	-	-	R+	R
Scheduled Processing Applications Code Sequence	(0040,4004)				
>Code Value	(0008,0100)	O	R	O	R
>Coding Scheme Designator	(0008,0102)	O	R	O	R
>Code Meaning	(0008,0104)	-	-	O	R

Attribute Name	Tag	Query Keys Matching		Query Keys Return	
		SCU	SCP	SCU	SCP
Scheduled Station Name Code Sequence	(0040,4025)				
>Code Value	(0008,0100)	R+	R	R+*	R
>Coding Scheme Designator	(0008,0102)	R+	R	R+*	R
>Code Meaning	(0008,0104)	-	-	R+	R
Scheduled Station Class Code Sequence	(0040,4026)				
>Code Value	(0008,0100)	O	R	O	R
>Coding Scheme Designator	(0008,0102)	O	R	O	R
>Code Meaning	(0008,0104)	-	-	O	R
Scheduled Station Geographic Location Code Sequence	(0040,4027)				
>Code Value	(0008,0100)	O	R	O	R
>Coding Scheme Designator	(0008,0102)	O	R	O	R
>Code Meaning	(0008,0104)	-	-	O	R
Scheduled Procedure Step Start Date and Time	(0040,4005)	R+	R	R+	R
Expected Completion Date and Time	(0040,4011)	O	R	O	R
Scheduled Human Performers Sequence	(0040,4034)				
>Human Performer Code Sequence	(0040,4009)				
>>Code Value	(0008,0100)	R+	R	R+*	R
>>Coding Scheme Designator	(0008,0102)	R+	R	R+*	R
>>Code Meaning	(0008,0104)	-	-	R+	R
>Human Performer's Name	(0040,4037)	R+	R+	R+	R+
>Human Performer's Organization	(0040,4036)	O	O	O	R+
Referenced Study Component Sequence	(0008,1111)				
>Referenced SOP Class UID	(0008,1150)	O	O	O	R
>Referenced SOP Instance UID	(0008,1155)	O	O	O	R
Input Information Sequence	(0040,4021)				
>Study Instance UID	(0020,000D)	O	O	R+*	R
>Referenced Series Sequence	(0008,1115)				
>>Series Instance UID	(0020,000E)	O	O	R+*	R
>>Retrieve AE Title	(0008,0054)	O	O	O	R
>>>Storage Media File-Set ID	(0088,0130)	O	O	O	O
>>>Storage Media File-Set UID	(0088,0140)	O	O	O	O
>>>Referenced SOP Sequence	(0008,1199)				
>>>>Referenced SOP Class UID	(0008,1150)	O	O	R+*	R
>>>>Referenced SOP Instance UID	(0008,1155)	O	O	R+*	R
Relevant Information Sequence	(0040,4022)				
>Study Instance UID	(0020,000D)	O	O	O	R

Attribute Name	Tag	Query Keys Matching		Query Keys Return	
		SCU	SCP	SCU	SCP
>Referenced Series Sequence	(0008,1115)				
>>Series Instance UID	(0020,000E)	O	O	O	R
>>Retrieve AE Title	(0008,0054)	O	O	O	O
>>Storage Media File-Set ID	(0088,0130)	O	O	O	O
>>Storage Media File-Set UID	(0088,0140)	O	O	O	R
>>Referenced SOP Sequence	(0008,1199)				
>>>Referenced SOP Class UID	(0008,1150)	O	O	O	R
>>>Referenced SOP Instance UID	(0008,1155)	O	O	O	R
Resulting General Purpose Performed Procedure Step Sequence	(0040,4015)				
>Referenced SOP Class UID	(0008,1150)	O	O	O	R
>Referenced SOP Instance UID	(0008,1155)	O	O	O	R
Actual Human Performers Sequence	(0040,4035)				
>Human Performer Code Sequence	(0040,4009)				
>>Code Value	(0008,0100)	O	O	O	R
>>Coding Scheme Designator	(0008,0102)	O	O	O	R
>>Code Meaning	(0008,0104)	-	-	O	R
>Human Performer's Name	(0040,4037)	O	O	O	R+
>Human Performer's Organization	(0040,4036)	O	O	O	R+
Study Instance UID	(0020,000D)	O	O	R+*	R
Multiple Copies Flag	(0040,4006)	O	O	O	R
All other Attributes from the General Purpose Scheduled Procedure Step Information Module		O	O	O	O
<b>General Purpose Scheduled Procedure Step Relationship</b>					
Referenced Request Sequence	(0040,A370)				
>Study Instance UID	(0020,000D)	O	O	R+*	R
>Referenced Study Sequence	(0008,1110)				
>>Referenced SOP Class UID	(0008,1150)	O	O	R+*	R
>>Referenced SOP Instance UID	(0008,1155)	O	O	R+*	R
>Requested Procedure ID	(0040,1001)	R+	R+	R+	R
>Requested Procedure Description	(0032,1060)	O	O	O	R
>Requested Procedure Code Sequence	(0032,1064)				
>>Code Value	(0008,0100)	O	O	O	R
>>Coding Scheme Designator	(0008,0102)	O	O	O	R
>>Code Meaning	(0008,0104)	-	-	O	R
>Accession Number	(0008,0050)	R+	R	R+	R
>Requesting Physician	(0032,1032)	O	O	O	R

Attribute Name	Tag	Query Keys Matching		Query Keys Return	
		SCU	SCP	SCU	SCP
>All other Attributes relating to the Requested Procedure and the Imaging Service Request in the General Purpose Scheduled Procedure Step Relationship Module		O	O	O	O
<b>Patient Relationship</b>					
All Attributes from the Patient Relationship Module		O	O	O	O
<b>Patient Identification</b>					
Patient's Name	(0010,0010)	R+	R	R+	R
Patient ID	(0010,0020)	R+	R	R+	R
All other Attributes from the Patient Identification Module		O	O	O	O
<b>Patient Demographic</b>					
Patient's Birth Date	(0010,0030)	O	O	R+	R
Patient's Sex	(0010,0040)	O	O	R+	R
All other Attributes from the Patient Demographic Module		O	O	O	O
<b>Patient Medical</b>					
All Attributes from the Patient Medical Module		O	O	O	O

9520 **4.46.4.1.3 Expected Actions**

The Report Manager performs the query and sends the matching General Purpose Worklist items to the Report Creator.

**4.46.4.2 Receive General Purpose Worklist Message**

9525 This is the message the Report Manager sends containing General Purpose Worklist information as a response to the Report Creator query.

**4.46.4.2.1 Trigger Events**

The Report Manager receives a query for a Worklist.

**4.46.4.2.2 Message Semantics**

9530 C-FIND Response from the DICOM General Purpose Worklist SOP Class will be used for this message. Some of the attributes queried through the worklist originate from other sources during previous steps in the workflow, and are made available to the Report Manager through other transactions such as MPPS. It is up to the Report Manager to determine the Input Information, e.g., study, series, etc. appropriate to be used in a workitem Scheduled Procedure Step, i.e., it is independent of the acquisition process and resulting MPPS.

9535 The Post-Processing Manager shall specify the type of task to be performed in the content of the Scheduled Workitem Code Sequence (0040,4018) using one of the following values from DCMR [CID 9231](#):

**Table 4.46-4: Reporting Workitem Definition**

Coding Scheme Designator (0008,0102)	Code Value (0008,0100)	Code Meaning (0008,0104)
DCM	110005	Interpretation
DCM	110006	Transcription
DCM	110007	Report Verification
DCM	110009	No subsequent Workitems

#### 4.46.4.2.3 Expected Actions

9540 A Report Creator displays the worklist to the user who might then select the item to work on. When the user selects the workitem and performs the report creation work, the Report Creator will notify the Report Creator of the work progress as defined in the Workitem Claimed and Workitem Completed transactions.

### 4.47 Distribute Imaging Information on Media [RAD-47]

#### 9545 4.47.1 Scope

In the Distribute Imaging Information on Media transaction the Portable Media Creator sends information to media reading actors by means of Interchange Media where it stores the information.

#### 4.47.2 Actor Roles

9550 **Actor:** Portable Media Creator

**Role:** Assemble the media content and store it on the media to be distributed.

**Actor:** Portable Media Importer

**Role:** Read the DICOM content of distributed media in order to access information stored in the DICOMDIR file and its referenced instances (DICOM FSR) and perform import of media data.

9555 **Actor:** Image Display

**Role:** Read the DICOM content of distributed media in order to access information stored in the DICOMDIR file (DICOM FSR) and display its referenced evidence objects.

**Actor:** Report Reader

9560 **Role:** Read the DICOM content of distributed media in order to access information stored in the DICOMDIR file (DICOM FSR) and read its referenced diagnostic reports.

**Actor:** Print Composer

**Role:** Read the DICOM content of distributed media in order to access information stored in the DICOMDIR file (DICOM FSR) and send print data (images) to the Print Server.

**Actor:** Display (from ITI TF)

9565 **Role:** Read the web-viewable content of distributed media in order to access information stored in the INDEX.HTM file and display its referenced data (XHTML files and JPEG images).

#### 4.47.3 Referenced Standard

DICOM [PS3.10](#): Media Storage and File Format for Data Interchange

DICOM [PS3.11](#): Media Storage Application Profiles

9570 DICOM [PS3.12](#): Media Formats and Physical Media for Data Interchange

XHTML™ 1.0 The Extensible HyperText Markup Language (Second Edition). A Reformulation of HTML 4 in XML 1.0. W3C Recommendation 26 January 2000, revised 1 August 2002.

<http://www.w3.org/TR/xhtml1>.

XHTML™ Basic. W3C Recommendation 19 December 2000. [http://www.w3.org/TR/xhtml-](http://www.w3.org/TR/xhtml-basic)

9575 [basic](#).

#### 4.47.4 Messages

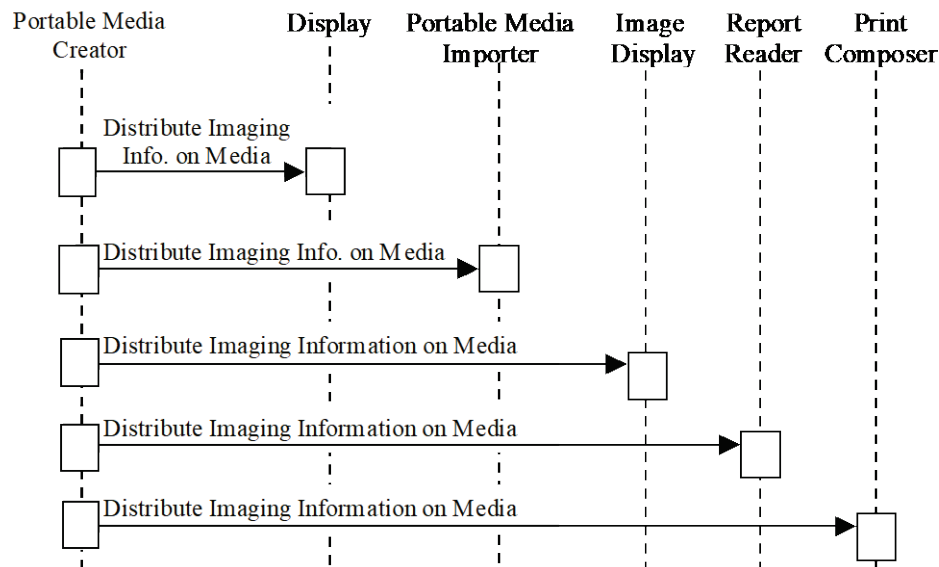


Figure 4.47.4-1: Interaction Diagram

##### 4.47.4.1 Distribute Imaging Information on Media

9580 This transaction consists of the interchange of information on media by way of the physical transport of the created media from the Portable Media Creator to a media-reading actor.

#### 4.47.4.1.1 Trigger Events

9585 The user at the Portable Media Creator wishes to transport information by the creation and transport of interchange media. The Portable Media Creator assembles the Interchange Media content and stores it on the media.

#### 4.47.4.1.2 Message Semantics

The message semantics of this transaction are described in terms of content specifications for the media.

9590 The Portable Media Creator shall be able to include all DICOM objects supported by the IHE actors with which it is grouped. If not grouped with any IHE actors, it shall be able to include all DICOM Storage objects listed in its DICOM Conformance Statement.

#### 4.47.4.1.2.1 Media Filesystem and File Naming Restrictions

Since the DICOM content on the media is required to conform to the DICOM standard, some of the requirements specified in DICOM PS3.10, 3.11 and 3.12 are reiterated here for emphasis:

- 9595
- Strict ISO 9660 Level 1 compliance with respect to file naming
  - No packet writing
  - File and folder names referenced by the DICOMDIR file restricted to 8 characters, uppercase letters, digits and underscore only, with no extension

9600 Specifically, it is not permitted to name DICOM files based on their SOP Instance UID, since that would exceed the 8 character limit and use the illegal period character, and it is not permitted to add a “.dcm” extension or similar. Filenames should not be in lower case, nor have lower case equivalent file names encoded as Joliet or Rockridge extensions to the ISO 9660 filesystem.

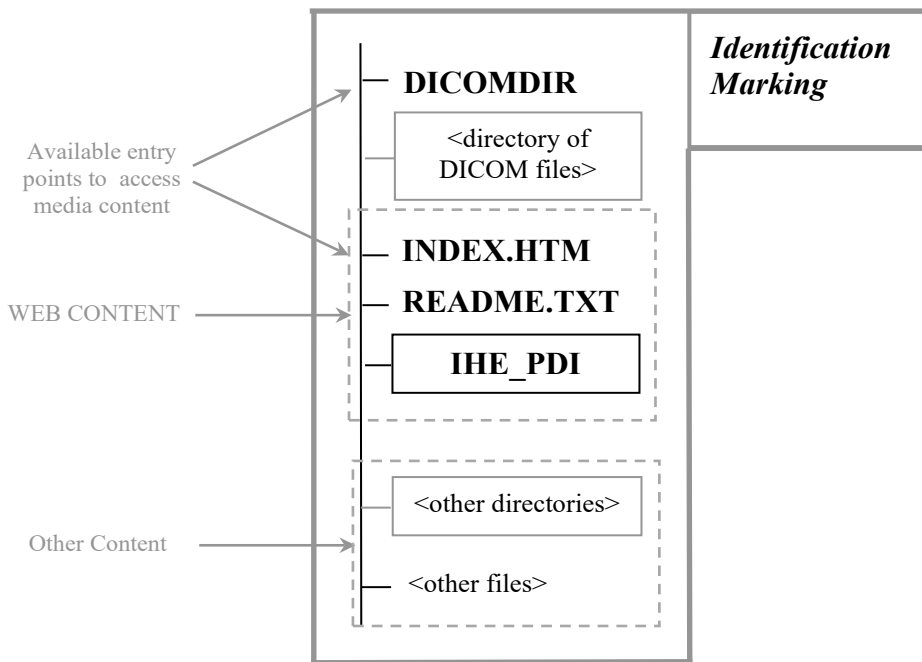
9605 Refer to RAD TF-2x: Appendix E for a reference to common implementation misinterpretations and/or errors that are detrimental to interoperability.

Non-DICOM data is restricted to ISO 9660 Level 1 compliance for media encoded with ISO 9660 rather than UDF or FAT filesystems, but without the restrictions on file extensions and characters imposed by DICOM; i.e., a 3 character extension is permitted.

#### 4.47.4.1.2.2 Content Organization Overview

9610 The following diagram illustrates the content organization principles (see RAD TF-2x: Appendix F for examples):





**Figure 4.47.4.1.2.2-1: Media Content Organization**

Description of the content to be contained in the media file system:

9615 **4.47.4.1.2.2.1 DICOM Content**

The **DICOMDIR** file shall be located in the root directory and shall reference all DICOM instances contained in the media.

9620 The DICOM instance files shall not be in the root directory or in the IHE\_PDI sub-directory, instead they shall reside in a sub-directory whose name is not otherwise constrained. No other DICOM instance files shall be placed on the media.

It is recommended, though not required, to include the README.TXT file described below, even if the Web Content Option is not supported.

**4.47.4.1.2.2.2 Web Content Option**

9625 Portable Media Creators implementing the Web Content Option shall meet the following requirements:

- **INDEX.HTM** file located in the root directory, which shall portray the exact content of the interchange media. The file shall present:
  - An informative header containing:
    - Identification of the institution that created the interchange media
    - 9630 ▪ Optionally, a link to an Internet-accessible site where, with the appropriate authentication and access control, a user may view the most recent version(s) of

the report(s) about the media content, since any report content on the media may have been amended

- 9635 ○ a link to an entry point for accessing the web content of the *IHE\_PDI* directory
- a link to the *README.TXT* file
- a link to additional non-constrained data (if it exists) – See Section 4.47.4.1.2.2.3
- a manifest which lists the data that can be imported by a Portable Media Importer. (i.e., all DICOM content on the media)
- 9640 ○ a manifest which lists any patient-related data contained on the CD that cannot be imported (i.e., additional non-constrained content that doesn't have an importable DICOM equivalent on the media).
- a link to a launch point for a DICOM viewer, if present on the interchange media

Note: The file *INDEX.HTM* is required to present the content defined above to the user. This does not imply that the information must necessarily be contained in *INDEX.HTM*. Instead, *INDEX.HTM* might also open a frame set consisting of additional *XHTML* files that in total contains the information specified above.

9645

- ***README.TXT*** file located in the root directory, that shall contain:
  - Contact information regarding the Institution that created the media.
  - Information regarding the Application that created the media.
    - 9650 ■ Name of the product application and software version
    - Contact information of the vendor of the application that created the media
  - General information about the overall organization of the interchange media. This is not intended to be specific to the content stored on this instance of interchange media, which, if necessary, should be placed in the *INDEX.HTM* file.
  - 9655 ○ Information regarding the Media Viewer application (if a Media Viewer is contained)
    - Operating system(s) supported
    - Name of the product application and software version
    - Contact information of vendor that provided the application
    - List of minimum requirements
    - 9660 ■ Additional information regarding the usage of the application

Note that generally the *README.TXT* file is independent of the clinical content of the media, i.e., the same *README.TXT* may be included on all media created by that application at that institution.

It is recommended that information is included in the *README.TXT* file about web browsers (including version number) that are known to be capable of displaying the web content as intended.

- 9665 ● ***IHE\_PDI*** directory located in the root directory of the interchange media which shall contain:

- Web-viewable objects in XHTML, JPEG, PNG and/or GIF derived from the DICOM encoded objects or used for web page navigation (see Section 4.47.4.1.2.3.2).
- The web content shall faithfully represent the patient’s clinical condition.
- 9670 ○ It is not allowed to place any other data in the *IHE\_PDI* directory.
- It is allowed to have sub-directories within the *IHE\_PDI* directory

Note: These are IHE requirements (not DICOM requirements) that are intended to facilitate the overall organization of the media and make easier the access to the INDEX.HTM file, especially for non-expert users like patients and referring physicians.

- 9675 Note: There is a recognized need for cine/video data, however a standardized method (format) has not yet been identified for endorsement by IHE and inclusion in this transaction.

#### 4.47.4.1.2.2.3 Optional Content

It is permitted to place other data on the media outside the *IHE\_PDI* directory. Any additional content shall take into account all constraints listed above especially:

- 9680 ● No DICOM instance files are allowed.
- This data shall be described or referenced as defined in Section 4.47.4.1.2.2.2.

Furthermore, any additional directory in the root directory not specified by other IHE profiles (such as XDM) cannot begin with “IHE”, and those folders shall not be used by PDI.

- 9685 Additional files (files other than mandatory files) in the root directory are not expressly prohibited however their inclusion is discouraged. Any viewing application on the media shall have a minimum number of files and launch file in the root directory. Any supporting files shall be contained in a minimum number of sub-directories in the root directory.

Note that it cannot be assumed that any automatically launching application will run on the receiving device.

#### 9690 4.47.4.1.2.2.3.1 DICOM Media Viewer and Basic Viewer Option

A Portable Media Creator that supports the Basic Viewer Option shall be capable of putting a DICOM Viewer that complies with the Basic Image Review Profile on the media.

The hardware and software requirements for the viewer are defined in the Basic Viewer Option of PDI (RAD TF-1: 15.6.1).

- 9695 If a DICOM media viewer is present on the media, it is recommended that:

- the media viewer be capable of correctly rendering all DICOM objects stored on the medium
- a user manual in PDF format be included on the medium, in the root directory
- a short manual in hardcopy be provided with the physical media
- 9700 ● if the viewing software is not capable of executing properly (e.g., wrong OS version, insufficient memory, insufficient display resolution), the software should do nothing or

9705 terminate with an error message explaining the problem in human understandable form (e.g., not “exception 0xf800” or “sys12345.dll is missing”) and without negatively affecting other programs or the operating system (i.e., the software should not crash the machine)

#### 4.47.4.1.2.2.4 Media Identification

9710 The Portable Media Creator shall support a user in adding human-readable identification information on the outside of the physical medium. The method of media marking is outside the scope of this integration profile.

It is recommended that the following be marked on the medium:

- Patient Name
  - Patient ID
  - birthdate
  - 9715 • media creation date
  - the study dates for the studies on the medium and
  - the name of the originating institution
  - If the Basic Viewer Option is used by the Portable Media Creator, then the label shall include an indication that an IHE Basic Image Review viewer is present (“IHE PDI BIR”).
- 9720

If the Media Creator prints a label on, or to be applied to, the physical media, then the label shall include information about the type of content and which options are used by the Portable Media Creator:

- The type of content (“DICOM” or “DICOM WEB”)
- 9725 • If the DVD Option is used by the Portable Media Creator
  - if the physical media is not a CD, then the label shall include an indication that a DVD drive is required to read the media.
  - if compression is used, then the label shall include an indication of which compressed Transfer Syntax (e.g., JPEG or JPEG 2000) was used.
- 9730 • For example, a typical label might include:
  - St. Elsewhere’s Radiology
  - John Smith #54672354 1973/04/02
  - CT Brain 2009/05/13
  - Recorded 2009/05/14 710

- 9735
- IHE PDI DICOM WEB DVD J2K BIR
  - For media that is physically small (e.g., a USB memory stick that is not packaged in a larger form, such as credit card size), it may be difficult to fit the required and recommended information, in which case only the required information should be used.
  - The labelling requirements and recommendations apply to the physical media itself and any directly applied label; it is not sufficient merely to label the package in which the media is transported, since the media may become separated from the package.
- 9740

#### **4.47.4.1.2.3 Content Organization Detail**

##### **4.47.4.1.2.3.1 DICOM Content**

9745 The DICOM portion of the media content is defined by the current DICOM standard. It is required that created file-sets be correctly formatted in order to grant maximum interoperability.

All DICOM data shall be referenced by the *DICOMDIR* file.

9750 The Portable Media Creator, Portable Media Importer, Image Display, Report Reader and Print Composer shall use the STD-GEN-CD Media Storage Application Profile to interchange DICOM information on interchange media, unless the DVD or USB Options are specified (see Section 4.47.4.1.4).

The Portable Media Creator is not required to be able to create media containing data from multiple patients. However, all media reading actors shall be able to import media containing multiple patients' data.

9755 While the Portable Media Creator is not required to correct DICOM SOP instances from a source that incorrectly encodes the DICOM data, it is expected that the DICOM Media Creator will store the DICOM files in Explicit VR Little Endian, unless the DVD or USB Options are specified (see Section 4.47.4.1.4). The DICOMDIR, whose content is entirely the responsibility of the Portable Media Creator, shall be correctly encoded regardless of the correctness of any referenced SOP Instances.

9760 The Portable Media Creator may be requested to include DICOM SOP Instances that do not contain sufficient information to encode mandatory DICOMDIR information. For example, Patient ID and Study ID are Type 2 and may be zero length in image SOP Instances, but are Type 1 in the Patient and Study Directory Records. The complete list of attributes which fall into this category for the STD-GEN-CD Media Storage Application Profile is in Table 4.47.4-1.

9765 **Table 4.47.4-1: Optional or Empty DICOM SOP Instance Attributes required in DICOMDIR**

Directory Record Type	Attribute Name	Tag
PATIENT	Patient ID	(0010,0020)
STUDY	Study ID	(0020,0010)
	Study Date	(0008,0020)
	Study Time	(0008,0030)
SERIES	Modality	(0008,0060)
	Series Number	(0020,0011)
IMAGE	Instance Number	(0020,0013)

The DVD and USB Options contain additional such Attributes that are optional in the SOP Instance but are required in the DICOMDIR (see Section 4.47.4.1.4).

9770 The Portable Media Creator is required to synthesize appropriate values for all such mandatory attributes. No specific guidance is given as to from whence appropriate values should be obtained or what default values are appropriate, except that different patients, studies, and series must remain distinct (e.g., two different Studies with differing Study Instance UIDs shall not be assigned the same synthesized Study ID). There is no firm requirement that a synthesized Patient ID must be globally unique as it is not a UID. However, it is the only Type 1 attribute for Patient 9775 Directory Records and is a key index value for searching. Any synthesized Patient ID values shall be unique, at least in the context of the DICOMDIR on the media being created, so that each corresponding Patient Directory Record will be guaranteed to be unique. Implementers must also be careful to ensure that multiple Patient Directory Records do not link to Study Directory Records with the same Study Instance UID. The requirements for synthesizing new 9780 Study ID values are less rigid as Study Directory Records are still guaranteed to have unique Study UID values. The Portable Media Creator is not required to add these synthesized values to the instances to be stored on media.

#### 4.47.4.1.2.3.1.1 DICOM Instances Content

9785 There are no additional requirements specified here on the Attributes contained within DICOM Instances on the media.

If the Portable Media Creator is grouped with an Acquisition Modality (or other) within the Scheduled Workflow Integration Profile, then the attributes may effectively be constrained beyond the normative requirements of the DICOM standard. For example, certain attribute values in the Modality Worklist query shall be included.

9790 However, since such grouping is not required under this profile, actors receiving created media such as the Portable Media Importer, Image Display, Report Reader and Print Composer may not assume that the DICOM Instance Attributes are constrained beyond the definitions of the IODs in the DICOM Standard.

9795 The instances on the Interchange Media generated by a Portable Media Creator shall all be DICOM Composite IODs. Therefore, the Interchange Media shall not contain instances from the following SOP Classes:

- Detached Patient Management SOP Class
- Detached Study Management SOP Class
- Detached Visit Management SOP Class
- 9800 • Study Component Management SOP Class
- Modality Performed Procedure Step SOP Class
- Detached Result Management SOP Class
- Detached Interpretation Management SOP Class
- Stored Print Storage SOP Class

9805 The Media Creator shall not change the values of the stored pixels, though it may change the encoding. It is required that images on the PDI media be of diagnostic quality (RAD TF-1:15.4), hence for Options that support the use of lossy (irreversible) image compression, the Portable Media Creator shall not:

- 9810 • apply lossy compression to images just for the purpose of exchange (e.g., to fit on the media or to accelerate load time); images can be encoded in lossy compressed form if and only if this is the form in which they had been made available to the Portable Media Creator (see also Media Exchange Certification Project of the German Radiological Society rule 3.1.3.8 <http://www.dicom-cd.de/docs/DRG-RequirementsSpecification-2006.pdf>).
- 9815 • alter the bit depth or rescaling or color space of an image in such a manner that information is lost in order to allow compression (lossless or lossy) to be applied (e.g., to change an image containing 16 bits of data to 12 bits to allow JPEG compression to be applied).

#### **4.47.4.1.2.3.1.2 DICOMDIR Directory Content**

9820 There are no additional DICOMDIR keys required beyond those required by the DICOM STD-GEN-CD specification, or the appropriate profile used with the DVD or USB Options (see Section 4.47.4.1.4).

No private elements shall be included in the standard directory records and no private directory records shall be present.

9825 The following types of Directory shall not be used in the Basic Directory object (DICOMDIR File):

- VISIT
- RESULTS

- INTERPRETATION
- 9830 • STUDY COMPONENT
- STORED PRINT
- TOPIC
- PRIVATE

The PATIENT, STUDY, SERIES Directory Records shall follow the following rules:

- 9835 • Only one Directory Record per Patient ID shall be present in the DICOMDIR.
- Only one STUDY Directory Record per Study Instance UID shall be present in the DICOMDIR; this implies that a study belongs to a single patient.
- Only one SERIES Directory Record per Series Instance UID shall be present in the DICOMDIR; this implies that a series belongs to a single study.
- 9840 • Only one composite instance level Directory Record shall be present per SOP Instance UID; this implies that an instance belongs to only a single series.
- Only one HL7 STRUC DOC Directory Record shall be present per SOP Instance UID; this implies that an instance belongs to only a single Patient.
- 9845 • Only one HANGING PROTOCOL Directory Record shall be present per SOP Instance UID

Users should review the supported Media Storage SOP Classes in the Conformance Statements of media creators and readers to ensure interoperability in the interchange of media objects.

- There is no requirement to include Icon Image Sequences in DICOMDIR Directory Records. However, their presence at the SERIES level, or the IMAGE level for multi-frame images, may be helpful to improve performance in a viewer that provides visual information for the user to navigate. Accordingly, it is strongly recommended that such Icon Image Sequences be present, without causing excessive increase in size of the DICOMDIR file.
- 9850

- 9855 

Note: The Transfer Syntax for the DICOMDIR is always Explicit VR Little Endian, and this precludes the use of any form of compression for Icon Image Sequences in the DICOMDIR, since the Transfer Syntax that defines the encoding of the nested Pixel Data is the same for the top-level data.

#### **4.47.4.1.2.3.1.3 DICOM Report Content**

It is possible to place diagnostic reports on the media.

- 9860 

Note: The report on or accompanying the media may be obsolete if a report is amended or corrected subsequently. Other means that recording on media are widely used to distribute up to date reports (e.g., fax and email), and it is potentially unsafe to rely on the report on media for clinical decision making.

The Portable Media Creator, if grouped with a Report Creator, shall support the ability to create a diagnostic imaging report. A Basic Text DICOM SR, according to a proper subset of the Simple Image Report Pattern as defined by the SINR Integration Profile, can be created and this kind of diagnostic report can be imported by a Portable Media Importer.



9865 Additional optional diagnostic reports in non-DICOM formats (such as HL7 CDA) are not defined by this transaction and may be placed on the media without the need to create DICOM SRs or DICOM Encapsulated PDF or DICOM Encapsulated CDA, but they will be non-importable data. See also the [Cross-Enterprise Document Sharing Media Interchange \(XDM\) Profile](#) in the IHE ITI Technical Framework.

9870 **Note:** This requirement may be met with other DICOM SR SOP Classes that are used for diagnostic or therapeutic reports. For the most basic radiology report, a simple pattern with one or more sections including a paragraph of text meets this requirement. Image references do not have to be included, but may be if so desired.

#### 4.47.4.1.2.3.2 Web Content Option

9875 Portable Media Creators claiming the Web Content Option shall meet the following requirements:

End-users should be able to access information at a minimum using a web browser to view content on media. In order to grant maximum interoperability using the stored XHTML files, they shall be formatted according to the XHTML Basic and W3C HTML Compatibility Guidelines provided in Appendix C of the W3C XHTML 1.0 Recommendation.

9880 The web-viewable data that is generated by Portable Media Creators claiming the Web Content Option shall:

- contain the web representation of a subset that faithfully preserves the clinical intent of the media's DICOM information, using only XHTML files, JPEG referenced images, and PNG and/or GIF files used for navigation,
- contain hyperlinks within XHTML files which contain only lowercase letters to promote interoperability across O/S Platforms,
- reside in the *IHE\_PDI*, while the corresponding DICOM data from which it is derived is located in a different sub-directory (see Section 4.47.4.1.2.2.1), and
- be completely referenced in the *INDEX.HTM* file

9890 The web-viewable data included shall be a set or subset that was considered at the time of creation to faithfully represent the patient's clinical condition. While it may be a subset, merely listing the contents is insufficient to satisfy this requirement, and if DICOM images are present on the media, for example, there shall be images in the Web Content. Though not required to be of diagnostic quality, Web Content images shall be a faithful representation and not excessively compressed nor excessively small (e.g., a 32x32 image of a 512x512 original would not be a faithful representation). For multi-frame original images, a sufficient number of frames shall be rendered to be a faithful representation.

9895 If the Portable Media Creator supports Presentation States, it shall have the capability to apply them to the relevant images when including web-viewable content. The user of the application may choose not to make use of this capability.

9900 The constraints placed by DICOM on the ISO 9660 file system are not required for web-viewable content, i.e., a 3-character extension is permitted.

9905 To ensure interoperability, JPEG means a file with a JFIF header and encoded using the sequential Huffman DCT 8bit per component process (baseline), and the progressive variant thereof.

9910 To ensure interoperability the use of XHTML shall be limited to static and restricted forms of dynamic web content. At this time Dynamic Web Content such as DHTML and most Scripting Languages are explicitly prohibited as no single established Standard exists to ensure interoperability between web browsers. The use of JavaScript is explicitly permitted, recognizing that there may be issues with different browsers. Portable Media Creators should make every effort to use portable constructs or use JavaScript that works with or adapts to all known portable browsers; further, the failure of JavaScripts should not make the resulting web pages unusable, by which it is meant that the static content shall be understandable as a faithful representation of the clinical condition without JavaScript.

9915 Because XHTML rather than legacy HTML is required, it is necessary to provide information about appearance using either embedded styles or an external stylesheet, since legacy attributes controlling appearance are not permitted in XHTML Strict. The use of Cascading Stylesheets (CSS) is explicitly permitted, recognizing that there may be issues with different browsers. Portable Media Creators should make every effort to use portable constructs or use CSS that works with or adapts to all known portable browsers; further, the failure of CSS should not make the resulting web pages unusable, by which it is meant that the static content shall be understandable as a faithful representation of the clinical condition without CSS.

Additional optional web-viewable content not derived from DICOM objects may be stored on the media, but not in the *IHE\_PDI* directory.

#### 9925 **4.47.4.1.2.3.3 Content when Grouping with XDM (IHE ITI Technical Framework)**

A PDI Portable Media Creator that is grouped with a Portable Media Creator in the ITI [Cross-Enterprise Document Sharing on Media \(XDM\)](#) Profile is able to create media with combined DICOM and XDM content. The grouped actor will be referred to as the Portable Media Creator.

9930 The Portable Media Creator shall assemble the necessary PDI content according to the specification in [ITI TF-2: 3.32.4.1](#) with the following additional requirements:

- The content of the INDEX.HTM and README.TXT files of PDI and XDM shall be merged to one INDEX.HTM and one README.TXT file. The resulting files shall meet all requirements of both profiles (PDI and XDM).
- All DICOM instances shall be referenced by a Key Object Selection (KOS) instance with a document title of (113030, DCM, “Manifest”). This helps the Portable Media Importer to recognize such a KOS instance (see Section 4.47.4.1.3.4) during the import process and distinguish it from any other KOS instances, e.g., Key Image Notes (KIN). If a manifest KOS instance is not available, it shall be created by the Portable Media Creator. The XDM Manifest METADATA.XML then references the KOS instance which in turn references multiple DICOM instances. In cases where multiple patients/ studies are stored on the media, there may be multiple Manifest KOS instances in order to distinguish the patients/ studies during import.

- Each Manifest KOS instance shall be referenced in the METADATA.XML file as defined in the XDM Profile.

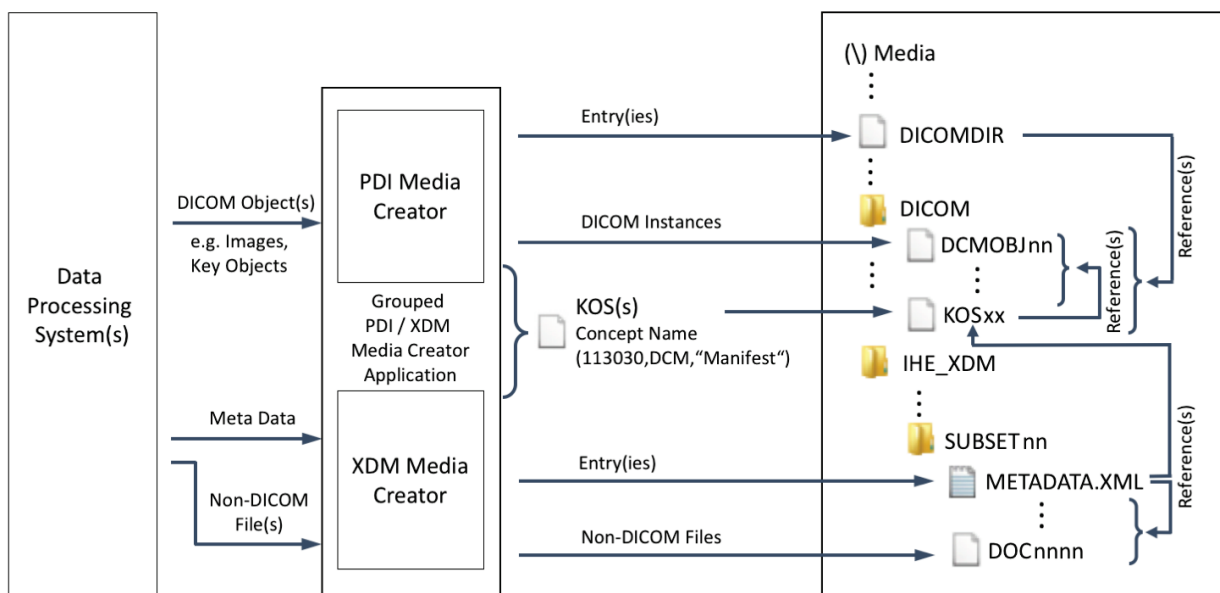
9945

- The Manifest KOS instance(s) shall be stored in the DICOM sub-directory of the PDI media structure and referenced in the DICOMDIR file as specified in Section 4.47.4.1.2.2.1.

Note: Although it is not prohibited to reference in the METADATA.XML all of the DICOM instances, this is not recommended since it is redundant with the content of the KOS instance, it increases the bulk of the METADATA.XML, and it raises the risk of inconsistency between the two lists.

9950

Figure 4.47.4.1.2.3.3-1 illustrates the processing chain for the Portable Media Creator.



**Figure 4.47.4.1.2.3.3-1: Processing Chain – Portable Media Creator**

9955

### 4.47.4.1.3 Expected Actions

The receiving/reading actors (Portable Media Importer, Image Display, Report Reader, Print Composer and Display) read the patient’s data from the media and act upon it as specified below. The receiving actor shall document which DICOM objects it supports in its Conformance Statement. If a SOP Class on the media is not supported, the actor shall present the user with a summary of the data that could not be acted upon, containing the Patient Name(s) and ID(s), Study ID(s), Study Date(s), Study and Series Description(s) and Modality as obtained (if present) from the *DICOMDIR* file.

9960

The automatic launching of applications is not expressly prohibited on media interchanged within this profile; its use is discouraged, however.

9965

To facilitate avoidance of malicious software, receiving actors are not required to launch automatically running applications present on media.

**4.47.4.1.3.1 Expected Actions Common to All Actors**

9970 All receiving actors that support the DVD Media Option or the USB Media Option shall be able to read all types of media and Transfer Syntaxes specified in the corresponding DICOM Media Application Profiles defined for the option, which includes the ability to decompress all specified compression schemes.

**4.47.4.1.3.2 Image Display**

9975 The Image Display reads the DICOM image data from the media and provides the user with the ability to view all studies (that it supports) contained on the media. GSPS objects and Key Image Notes are read from the media and applied if the Consistent Presentation of Images (CPI) or the Key Image Notes (KIN) Profiles are supported. The Image Display may optionally be grouped with other actors that view other evidence objects.

**4.47.4.1.3.3 Report Reader**

9980 The Report Reader reads the DICOM SR Reports from the media and may process them (based on the SR object classes it supports). At a minimum, it provides the user with the ability to view all reports per the DICOM SR SCP requirements.

**4.47.4.1.3.4 Portable Media Importer**

9985 The Portable Media Importer reads DICOM data from the media. Together with the actor with which it is grouped (see RAD TF-1: 2.5), it shall be able to perform key attribute reconciliation on attributes in Table 4.47.4-2. The Portable Media Creator might not be required to perform reconciliation in all deployments (e.g., within the same importing institution/enterprise, the values in the imported object may already match what is expected by the importing institution/enterprise).

9990 The Import Reconciliation Workflow Profile provides mechanisms to obtain the necessary values to reconcile the key attributes below. (See the [Import Reconciliation Workflow \(IRWF.b\)](#) Trial Implementation Supplement.)

The grouped actors provide the capability of storing the supported DICOM objects to an Image Manager/ Image Archive (for image objects like Images, Presentation States, Key Image Notes, Evidence Documents), or to a Report Repository (for Diagnostic Reports).

9995 **Table 4.47.4-2: Media instances – Key attributes to be reconciled**

Attribute from Media	Updating action
Patient Name	Replace with value from ADT (See Note 1)
Patient ID	Replace with value from ADT (See Note 1)
Patient’s Birth Date	Replace with value from ADT (See Note 1)
Patient’s Sex	Replace with value from ADT (See Note 1)
Study Instance UID	Remains unchanged
Series Instance UID	Remains unchanged
SOP Instance UID	Remains unchanged

Attribute from Media	Updating action
Workflow-related Identifying Attributes (e.g., Order, Requested Procedure, Scheduled and Performed IDs and UIDs).	Values from such identifying attributes of media information <ul style="list-style-type: none"> <li>• remain unchanged,</li> <li>• are replaced with a value from the local environment, or</li> <li>• are removed (zero length value). (See Note 3)</li> </ul> The exact method of reconciliation depends on the importing institution's procedures, and goes beyond the IHE scope.
Descriptive performed procedure information (this is information that pertains to the manner in which the information was created (e.g., acquisition context) or it may be payload of the instance (e.g., image structure, document content))	Remains unchanged (see Note 2).

Note 1: The manner in which the Portable Media Importer receives the ADT value is beyond the scope of this transaction.

Note 2: Handling of Coded information is beyond the scope of this transaction.

Note 3: The Referenced Study Sequence and Requested Attributes Sequence (which contain Workflow Identifying Attributes) are omitted in the unscheduled case of Scheduled Workflow, so removing them during import would be consistent with that behavior.

10000

#### 4.47.4.1.3.4.1 Grouping with XDM (IHE ITI Technical Framework)

A PDI Portable Media Importer that is grouped with a Portable Media Importer in the ITI [Cross-Enterprise Document Sharing on Media \(XDM\)](#) Profile is able to import media with combined DICOM and XDM content. The grouped actor will be referred to as the Portable Media Importer.

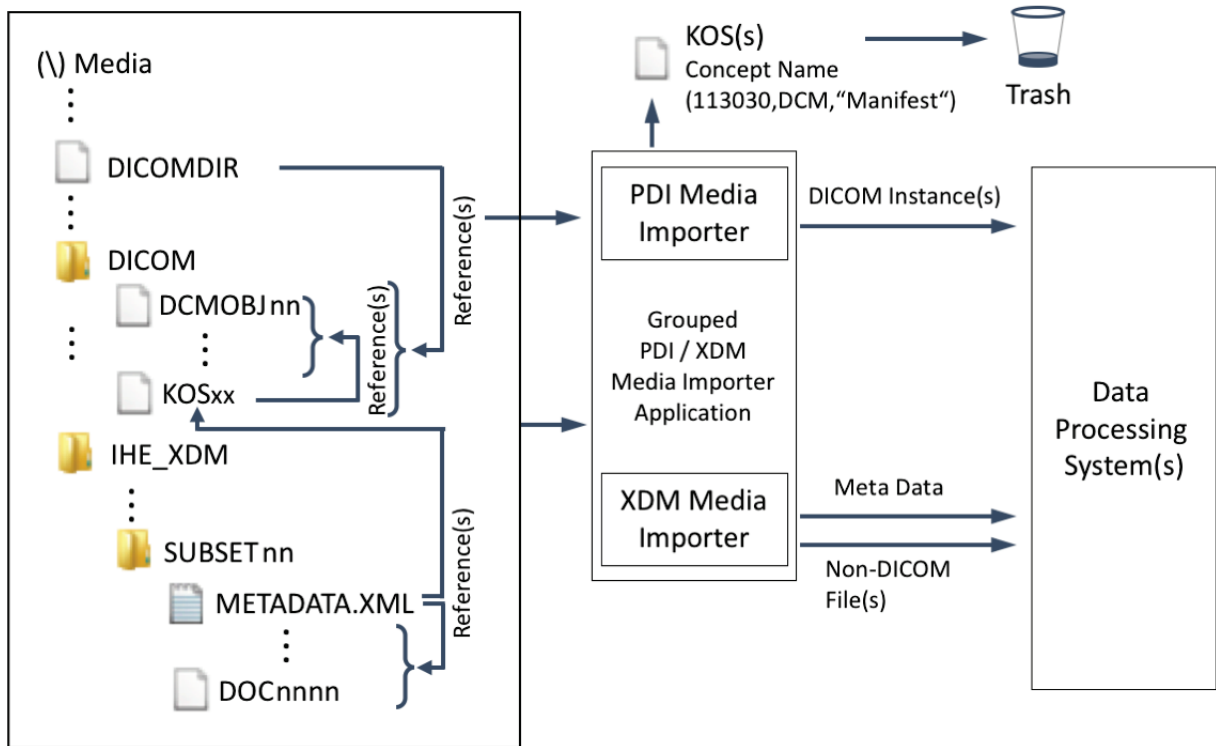
10005

The Portable Media Importer shall process the PDI content according to the specification in [ITI TF-2: 3.32.4.1.4](#) with the following additional requirements:

- The Manifest KOS instances (as described in Section 4.47.4.1.2.3.3) shall not be imported as they are only meant to provide an overview of the DICOM instances present on the media to the Portable Media Importer.

10010

Figure 4.47.4.1.3.4.1-1 illustrates the processing chain for the Portable Media Importer.



**Figure 4.47.4.1.3.4.1-1: Processing Chain – Portable Media Importer**

10015 **4.47.4.1.3.5 Print Composer**

The Print Composer reads the DICOM image data from the media and provides a means to print it.

**4.47.4.1.3.6 Display**

10020 The Display reads the web-viewable information from the media and displays it. Note that the web-viewable content will only be present if the Portable Media Creator involved supports the Web Content Option.

**4.47.4.1.4 Media Options**

The baseline media type is CD using the DICOM STD-GEN-CD Media Storage Application Profile.

10025 Options are provided for DVD Media and USB Media.

**4.47.4.1.4.1 DVD Media Option**

A Portable Media Creator that supports the DVD Media Option shall create media that complies with either the DICOM STD-GEN-DVD-JPEG or STD-GEN-DVD-J2K Media Application Profiles, as defined in DICOM [PS3.11 Annex H](#).

10030 A Portable Media Importer that supports the DVD Media Option shall be capable of reading any media written with the DICOM STD-GEN-DVD-JPEG and any media written with the STD-GEN-DVD-J2K Media Application Profiles.

In summary, these DICOM Media Application Profiles specify:

- 10035 • the use of any of the conventional (non-HD) 120 mm DVD-compatible media except DVD-RAM, specifically CD, DVD-R authoring and general, DVD-RW, DVD+R and DVD+RW (see DICOM [PS3.12 Annex P](#)), which means that the Portable Media Creator can create any of these choices, and the receiving actors shall be capable of reading all of them
- 10040 • the use of UDF or ISO 9660 (or both) as a filesystem, which means the Portable Media Creator can create either (or both), but the receiving actors shall be capable of reading either
- 10045 • the use of uncompressed images, or compressed images using JPEG lossy (8 or 12 bits) or lossless (up to 16 bit), or JPEG 2000 reversible or irreversible (up to 16 bit) schemes, which means the Portable Media Creator can make a choice, but receiving actors shall be capable of decompressing all of them
- additional DICOMDIR keys that shall be included by the Portable Media Creator (which are listed in DICOM [PS3.11 Section H.3.3.1](#))

Several other DICOM Media Application Profiles are effectively subsumed by the DICOM STD-GEN-DVD-JPEG profile. In particular, a Portable Media Creator that creates media using such a DICOM Media Application Profile will create media that is readable by a receiving actor that supports the DVD Media Option and hence the DICOM STD-GEN-DVD-JPEG profile. This is true as long as the received supports the encoded SOP Classes, which is true of any PDI media, and any additional required DICOMDIR keys are present. This includes profiles that create CD media that is readable in a DVD drive. Those DICOM Media Application Profiles, with any exceptions related to specific Transfer Syntaxes noted, are:

- 10055 • STD-CTMR-CD
- STD-US-ID-SF-CDR, STD-US-ID-MF-CDR, STD-US-SC-SF-CDR, STD-US-SC-MF-CDR, STD-US-CC-SF-CDR, and STD-US-CC-MF-CDR, except that RLE Lossless Image Compression is unsupported
- 10060 • STD-XABC-CD
- STD-XA1K-CD

#### **4.47.4.1.4.2 USB Media Option**

10065 A Portable Media Creator that supports the USB Media Option shall create media that complies with either the DICOM STD-GEN-USB-JPEG or STD-GEN-USB-J2K Media Application Profiles, as defined in DICOM [PS3.11 Annex J](#).



A Portable Media Importer that supports the USB Media Option shall be capable of reading any media written with the DICOM STD-GEN-USB-JPEG and any media written with the STD-GEN-USB-J2K Media Application Profiles.

The USB media shall have a Type A physical connector (DICOM has no such restriction).

10070 In summary, these DICOM Media Application Profiles specify:

- the use of any USB-Connected Removable Storage Devices (see DICOM [PS3.12 Annex R](#)), which includes the typical “memory stick” or “thumb drive”
- the use of a FAT16 or FAT32 filesystem
- the use of uncompressed images, or compressed images using JPEG lossy (8 or 12 bits) or lossless (up to 16 bit), or JPEG 2000 reversible or irreversible (up to 16 bit) schemes, which means the Portable Media Creator can make a choice, but the receiving actors shall be capable of decompressing all of them
- additional DICOMDIR keys that shall be included by the Portable Media Creator (which are specified in DICOM [PS3.11 Section J.3.3.1](#), and are the same as those for DVD specified in DICOM [PS3.11 Section H.3.3.1](#)).

10075

10080

## 4.48 Appointment Notification [RAD-48]

### 4.48.1 Scope

10085

In the Appointment Notification Transaction, a Department System Scheduler/Order Filler sends to an Order Placer new appointment bookings and appointment rescheduling which contains the date(s) and time(s) of the Scheduled Procedures Steps. It may also notify an Order Placer of the cancellation of appointment bookings.

### 4.48.2 Actor Roles

**Actor:** Department System Scheduler/Order Filler

10090

**Role:** Generates Appointment Notification messages and sends them to the corresponding Order Placer.

**Actor:** Order Placer

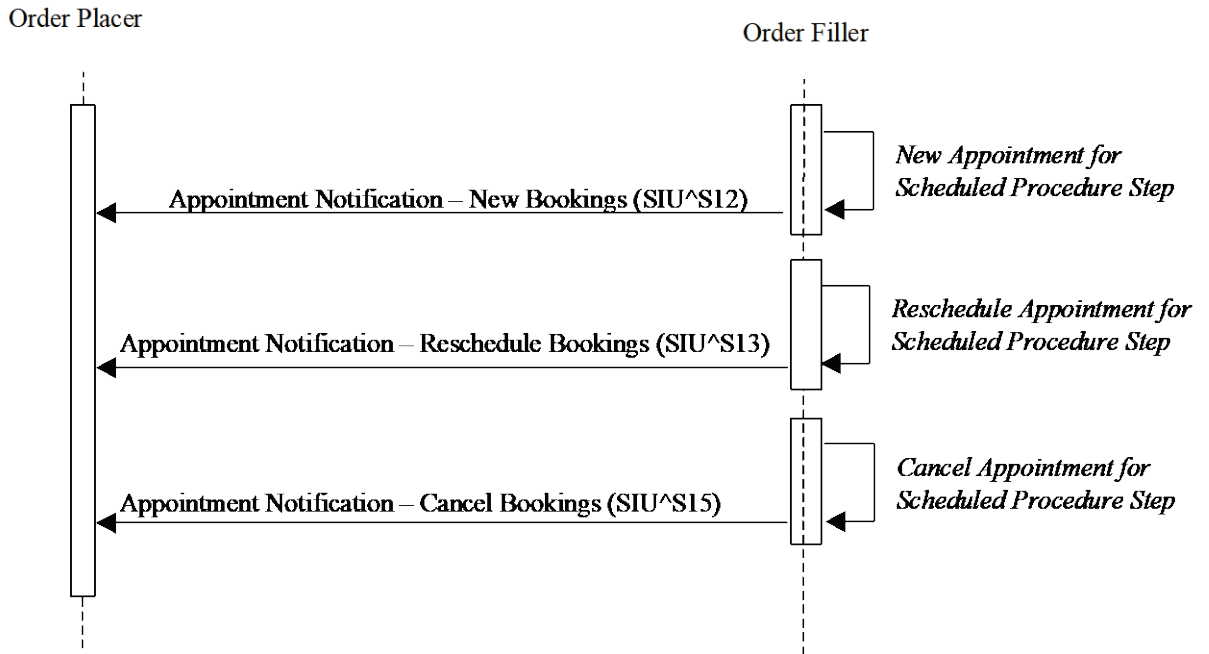
**Role:** Receives Appointment Notification messages and internally processes them.

### 4.48.3 Referenced Standard

HL7 V2.4, chapter 10.



10095 **4.48.4 Messages**



**Figure 4.48.4-1: Interaction Diagram**

**4.48.4.1 Appointment Notification - New Bookings**

**4.48.4.1.1 Trigger Events**

10100 SIU^S12 – Notification of New Appointment Booking

The DSS/Order Filler receives an order from an Order Placer. The DSS/Order Filler determines what procedure steps need to be scheduled. After scheduling the corresponding appointment(s), the DSS/Order Filler may send the Order Placer an Appointment Notification – New Appointment Booking message. Each appointment may satisfy zero or more Scheduled Procedure Steps. Information in the AIS segment describes the date(s) and time(s) of the appointment(s) that has been booked.

10105

**4.48.4.1.2 Message Semantics**

The message semantics follow the SIU^S12 message as specified in HL7 V2.4 Chapter 10. Refer to HL7 Standard for general message semantics. The cardinality of each segment is given within square brackets (minimum and maximum number of repetitions authorized).

10110

SIU^S12	Schedule Information Unsolicited	Chapter in HL7 V2.4
MSH	Message Header	2
SCH	Schedule Activity Information	10
{ RGS	Resource Group Segment	10

SIU^S12	Schedule Information Unsolicited	Chapter in HL7 V2.4
{ AIS	Appointment Information – Service	10
[[ NTE ]]	Notes and Comments	2
}		

10115 There is one group (RGS, AIS) per appointment booking. It is repeated when several appointment bookings have been made for the same Order. There must be at least one AIS segment (and therefore one RGS segment) since it contains timing information of the appointment.

Each message shall be acknowledged by the HL7 ACK message sent by the receiver of the SIU message to its sender. See Section 2.4.3 “Acknowledgement Modes” for definition and discussion of the HL7 ACK message.

**4.48.4.1.2.1 MSH Segment**

10120 The MSH segment shall be constructed as defined in Section 2.4.2.2 “Message Control”.

Field *MSH-9 Message Type* shall have at least two components. The first component shall have a value of SIU; the second component shall have a value of S12. The third component is optional; however, if present, it shall have a value of SIU\_S12.

**4.48.4.1.2.2 SCH Segment**

10125 The following table identifies required and optional fields of the SCH segment.

SEQ	LEN	DT	OPT	RP/#	TBL#	ITEM#	ELEMENT NAME
1	75	EI	O			00860	Placer Appointment ID
2	75	EI	R			00861	Filler Appointment ID
4	22	EI	C			00218	Placer Group Number
6	250	CE	R			00883	Event Reason
11	200	TQ	R	Y		00884	Appointment Timing Quantity
16	250	XCN	R	Y		00885	Filler Contact Person
20	250	XCN	O	Y		00878	Entered by Person
26	22	EI	R	Y		00216	Placer Order Number
27	22	EI	R	Y		00217	Filler Order Number

*Adapted from the HL7 Standard, version 2.4*

Field *SCH-1 Placer Appointment ID* contains the placer application’s permanent identifier for the appointment request. This field is not used.

10130 Field *SCH-2 Filler Appointment ID* contains the filler application’s permanent identifier for the appointment request. This field is required to be sent.

Field *SCH-4 Placer Group Number* shall be valued only if the Order Placer and the Order Filler utilize concept of Order Groups. Shall not be present otherwise.

10135 Field *SCH-6 Event Reason* is mandatory in HL7 V2.4 but not used by the Order Placer in this IHE transaction. In order to keep the compatibility with HL7 V2.4, it shall be sent by the Order Filler with the value ^APT.

Field *SCH-11 Appointment Quantity Timing* is mandatory in HL7 V2.4 but not used by the Order Placer in this IHE transaction. Dates and Times are set in the AIS segment. In order to keep the compatibility with HL7 V2.4, it shall be sent with a value set to 1.

10140 Field *SCH-16 Filler Contact Person* identifies the person responsible for the scheduling of the requested appointment. Most often, this person will be the same person responsible for maintaining the schedule or for reviewing appointment requests. This is the person to call if the appointment needs to be rescheduled or cancelled.

10145 Field *SCH-20 Entered by Person* identifies the person responsible for entering the request for the scheduling of an appointment. It is included to trace the persons responsible for the request.

Field *SCH-26 Placer Order Number* is the order number assigned by the placer application for the order associated with this scheduling filler response. In the context of IHE Radiology Scheduled Workflow, this field is required to be sent.

10150 Field *SCH-27 Filler Order Number* is the order number assigned by the filler application for the order associated with this scheduling filler response. In the context of IHE Radiology Scheduled Workflow, this field is required to be sent.

#### 4.48.4.1.2.3 RGS Segment

10155 The RGS segment is used to identify relationships between resources (date and time, location, medical staff) identified for a scheduled event. Related resources are defined in a group of resources. Each group starts with an RGS segment, followed by an AIS segment (for the date and time). The use of other segments (AIG, AIL, AIP) is beyond the scope of this integration profile. There must be one group per set of Scheduled Procedure Steps that are scheduled to take place during the same appointment.

10160 RGS segment shall be constructed as defined in Section 10.6.3 “RGS – Resource Group Segment” of HL7 V2.4 chapter 10 “Scheduling”. The following table identifies required and optional fields of the RGS segment.

SEQ	LEN	DT	OPT	RP/ #	TBL #	ITEM#	ELEMENT NAME
1	4	SI	R			01203	Set ID – RGS
2	3	ID	C		0206	00763	Segment Action Code
3	250	CE	O			01204	Resource Group ID

*Adapted from the HL7 Standard, version 2.4*

**4.48.4.1.2.4 AIS Segment**

10165 The AIS segment contains the date and time of a Scheduled Procedure. There is only one AIS segment per group of resources.

AIS segment shall be constructed as defined in Section 10.6.4 “AIS – Appointment Information – Service Segment” of HL7 V2.4 chapter 10 “Scheduling”. The following table identifies required and optional fields of the AIS segment.

10170

SEQ	LEN	DT	OPT	RP/ #	TBL #	ITEM#	ELEMENT NAME
1	4	SI	R			00890	Set ID – AIS
2	3	ID	R		0206	00763	Segment Action Code
3	250	CE	R			00238	Universal Service Identifier
4	26	TS	R			01202	Start Date/Time
5	20	NM	O			00891	Start Date/Time Offset
6	250	CE	O			00892	Start Date/Time Offset Units
7	20	NM	O			00893	Duration
8	250	CE	O			00894	Duration Units
9	10	IS	C		0279	00895	Allow Substitution Code
10	250	CE	C		0278	00889	Filler Status Code
11	250	CE	O	Y	0411	01474	Placer Supplemental Service Information
12	250	CE	O	Y	0411	01475	Filler Supplemental Service Information

*Adapted from the HL7 Standard, version 2.4*

Field *AIS-2 Segment Action Code* contains the action to be taken when adding, updating or modifying information in this segment. All AIS segments in the same RGS group shall contain the same action code. This field is required and is valued with: A (Add/Insert).

10175 Field *AIS-3 Universal Service Identifier* contains an identifier for the Scheduled Procedure Steps to be scheduled and the associated Requested Procedure Components. The 3 first components (“identifier”, “text”, “name of coding system”) contain the Requested Procedure Code (Code Value, Meaning and Coding Scheme). The fifth component (“alternate text”) shall contain a concatenated text description of the Scheduled Procedure Step(s) which can be understood at the Order Placer level. The fourth (“identifier”) and sixth (“name of coding system”) components are not used.

10180

Field *AIS-4 Start Date/Time* contains the date and time of the appointment. Both date and time are required. A time zone offset (from UTC) may be included. If the offset is not included the time zone is understood to be the local time zone of the sender. For example, 09:00 AM US Central Time on October 22, 2004 could be represented as: 200410220900-0600 or 200410220900 for a sender within the US Central time zone.

10185

**4.48.4.1.2.5 NTE Segment**

10190 Any information relative to the examination can be sent in NTE segments like Patient instructions (empty stomach, full or empty bladder), pre-medication (preliminary injection, biological examination), etc.

SEQ	LEN	DT	OPT	RP/#	TBL#	ITEM#	ELEMENT NAME
1	4	SI	R			00096	Set ID – NTE
2	8	ID	R			00097	Source of Comment
3	65536	FT	R			00098	Comment
4	250	CE	R			01318	Comment Type

*Adapted from the HL7 Standard, version 2.4*

Field *NTE-2 Source of Comment* identifies the source of the comment. This field is required but may be empty. Valid values are:

10195

Value	Description
L	Order Filler is the source of the comment
O	Other system is the source of comment

Field *NTE-3 Comment* contains the text of the comment. To delete a previously sent comment, the field shall contain empty quotation mark "".

Field *NTE-4 Comment Type* contains a value to identify the type of comment. Valid values are:

Value	Description
PI	Patient Instruction
AI	Ancillary Instruction
GI	General Instruction
RE	Remark

10200 **4.48.4.1.3 Expected Actions**

The Order Placer shall accept the appointment bookings as scheduled and shall return an HL7 ACK message.

**4.48.4.2 Appointment Notification – Reschedule Bookings**

**4.48.4.2.1 Trigger Events**

10205 SIU^S13 – Appointment Notification – Reschedule Bookings

In some cases, appointments may be rescheduled in the Radiology Department. This message is sent by the DSS/Order Filler to notify the Order Placer that an existing appointment has been

10210 rescheduled. The information in the AIS segment describes the new date(s) and time(s) to which the previously booked appointment has been moved. Additionally, it describes the unchanged information in the previously booked appointments.

**4.48.4.2.2 Message Semantics**

The message semantics follow the SIU^S13 message as specified in HL7 V2.4 Chapter 10. Refer to HL7 Standard for general message semantics.

SIU^S13	Schedule Information Unsolicited	Chapter in HL7 V2.4
MSH	Message Header	2
SCH	Schedule Activity Information	10
{ RGS	Resource Group Segment	10
{ AIS	Appointment Information – Service	10
[{ NTE }]	Notes and Comments	2
}		

10215 There is one group (RGS, AIS) per appointment booking. It is repeated when several appointment bookings have been made for the same Order. There must be at least one AIS segment (and therefore one RGS segment) since it contains timing information of the appointment.

10220 Each message shall be acknowledged by the HL7 ACK message sent by the receiver of the SIU message to its sender. See Section 2.4.3 “Acknowledgement Modes” for definition and discussion of the HL7 ACK message.

**4.48.4.2.2.1 MSH Segment**

MSH segment shall be constructed as defined in Section 2.4.2.2 “Message Control”.

10225 Field *MSH-9 Message Type* shall have at least two components. The first component shall have a value of SIU; the second component shall have a value of S13. The third component is optional; however, if present, it shall have a value of SIU\_S13.

**4.48.4.2.2.2 SCH, RGS, NTE Segments**

SCH, RGS and NTE segments shall be constructed as defined in Section 4.48.4.1.2 “Message Semantics” of the current proposition.

10230 **4.48.4.2.2.3 AIS Segment**

The segment shall be constructed as defined in Section 4.48.4.1.2.4 except for Field *AIS-2 Segment Action Code* which is valued with: U (Update).

**4.48.4.2.3 Expected Actions**

10235 The Order Placer shall accept the appointment information for rescheduling and shall return an HL7 ACK message.

### 4.48.4.3 Appointment Notification – Cancel Bookings

#### 4.48.4.3.1 Trigger Events

SIU^S15 – Appointment Notification – Cancel Booking

10240

This event is triggered when existing appointment bookings have been cancelled by an Order Filler.

#### 4.48.4.3.2 Message Semantics

The message semantics follow the SIU^S15 message as specified in HL7 V2.4 Chapter 10. Refer to HL7 Standard for general message semantics.

SIU^S15	Schedule Information Unsolicited	Chapter in HL7 V2.4
MSH	Message Header	2
SCH	Schedule Activity Information	10
{ RGS	Resource Group Segment	10
{ AIS	Appointment Information – Service	10
[{ NTE }]	Notes and Comments	2
}		

10245

There is one group (RGS, AIS) per appointment booking. It is repeated when several appointment bookings have been made for the same Order. There must be at least one AIS segment (and therefore one RGS segment).

Each message shall be acknowledged by the HL7 ACK message sent by the receiver of the SIU message to its sender. See Section 2.4.3 “Acknowledgement Modes” for definition and discussion of the HL7 ACK message.

10250

#### 4.48.4.3.2.1 MSH Segment

MSH segment shall be constructed as defined in Section 2.4.2.2 “Message Control”.

Field *MSH-9 Message Type* shall have at least two components. The first component shall have a value of SIU; the second component shall have a value of S15. The third component is optional; however, if present, it shall have a value of SIU\_S15.

10255

#### 4.48.4.3.2.2 SCH, RGS, NTE Segments

SCH, RGS and NTE segments shall be constructed as defined in Section 4.48.4.1.2 “Message Semantics”.

#### 4.48.4.3.2.3 AIS Segment

10260

The segment shall be constructed as defined in Section 4.48.4.1.2.4 except for:

- Field *AIS-2 Segment Action Code* is valued with: **D** (Delete).

#### 4.48.4.3.3 Expected Actions

10265 The Order Placer shall accept the appointment information for cancellation and shall return an HL7 ACK message. This message shall not be sent when the Order Filler or the Order Placer cancel an order. It is assumed that appointments are automatically cancelled by the Order Filler and that the Order Placer will take the same action.

### 4.49 Instance Availability Notification [RAD-49]

#### 4.49.1 Scope

10270 In the Instance Availability Notification Transaction, an Image Manager/Image Archive sends a message to relevant actors to inform them of the availability status of newly stored DICOM objects. Actors being notified are known to need these objects for fulfilling scheduled workflow processes and can retrieve and use the objects referenced in this message. This allows for supporting a variety of workflow conditions in imaging departments.

#### 4.49.2 Actor Roles

10275 **Actor:** Image Manager/Image Archive

**Role:** Generate an Instance Availability Notification message and send it to the DSS/Order Filler and optionally to other workflow managing actors (Post-Processing Manager, Report Manager).

**Actor:** DSS/Order Filler

**Role:** Receive an Instance Availability Notification message and internally process it.

10280 **Actor:** Post-Processing Manager

**Role:** Receive an Instance Availability Notification message and internally process it.

**Actor:** Report Manager

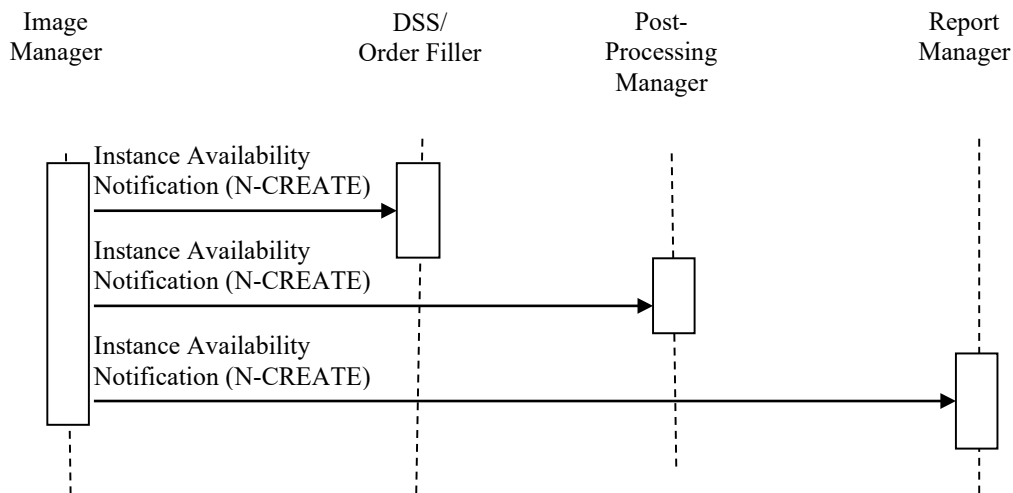
**Role:** Receive an Instance Availability Notification message and internally process it.

#### 4.49.3 Referenced Standard

10285 DICOM [PS3.4 Annex R](#): Instance Availability Notification Service Class



## 4.49.4 Messages



**Figure 4.49.4-1: Interaction Diagram**

### 4.49.4.1 Instance Availability Notification

10290 This message uses the DICOM Instance Availability Notification Service from an Image Manager/Image Archive to inform other workflow managing actors about the availability of DICOM instances they may be waiting for in order to be able to schedule or start procedure steps.

#### 4.49.4.1.1 Trigger Events

10295 During image acquisition, an MPPS-capable Acquisition Modality creates a set of instances and stores them to an Image Manager/Image Archive. Alternatively, as a part of importing Evidence Objects, an MPPS capable Importer imports instances and stores them to an Image Manager/Image Archive. The Image Manager/Image Archive, after having received the last instance of the instance set referenced in the MPPS Completed/Discontinued message or after a configurable timeout, shall send an Instance Availability Notification referencing the received instances to the DSS/Order Filler that has also received the related MPPS. It may also decide to send the Instance Availability Notification to other instance managing actors in the workflow to inform them that all instances referenced in the related MPPS are available.

10300

10305 One Instance Availability Notification shall be sent for each MPPS that contains references to instances. MPPS without references to instances shall not trigger the sending of an Instance Availability Notification. This applies to all the MPPS cases described in transaction [RAD-6] (Section 4.6 Simple Case, Unscheduled Case, Group Case, Append Case (Normal and Group Case, Abandoned Case) and in transaction [RAD-7] (Section 4.7 MPPS DISCONTINUED, except the case of incorrect worklist entry selected (Section 4.7.4.1.3.1). It also applies to the Import PPS cases described in Section 4.59.4.1.2. (Unscheduled Import and Unscheduled Import Cases) and Section 4.60.4.1.2.2 (Import PPS Discontinued).

10310

#### 4.49.4.1.2 Message Semantics

- 10315 The end of the image acquisition is indicated to the Department System Scheduler/Order Filler and Image Manager/ Image Archive by an MPPS Completed/Discontinued message from the Acquisition Modality referencing the DICOM instances that were created and are to be stored in the Image Manager/Image Archive. The end of the DICOM object import is indicated to the Department System Scheduler/Order Filler and Image Manager/ Image Archive by an Import MPPS Completed/Discontinued message from the Importer referencing the DICOM instances that were created and are to be stored in the Image Manager/Image Archive.
- 10320 Note that the MPPS and Instance Availability Notification inform about different events. Thus, depending on the total volume of the images stored and characteristics of the local system environment, the MPPS Completed/Discontinued may arrive considerably earlier at the DSS/OF than the Instance Availability Notification. The dependency of the IAN transaction on the MPPS Completed/Discontinued transaction may result in delayed notification to the DSS/OF of
- 10325 available instances, if the MPPS is not sent from the Acquisition Modality or Importer to the Image Manager/Image Archive in a timely fashion. This delay may be adjustable if there is a configurable timeout on the Image Manager/Image Archive regarding when to send the Instance Availability Notification.
- 10330 The Image Manager/Image Archive shall act as an Instance Notification SOP Class SCU and create an Instance Availability Notification SOP Class. It shall populate the Reference SOP Instance UID in the Referenced Performed Procedure Step Sequence. It shall include references to all received instances that are referenced in the corresponding MPPS. The Instance Availability (0008,0056) attribute of each instance shall be set to one of ONLINE, NEARLINE or OFFLINE if they are available for retrieve, or set to UNAVAILABLE if they are not available
- 10335 for retrieve (e.g., if the Image Manager deletes the referenced instances upon receiving a MPPS Discontinued message). The other attributes of the SOP Class are used as specified in DICOM.
- The Image Manager/Image Archive shall be able to send the Instance Availability Notification to multiple actors. The Image Manager/Image Archive shall send the Instance Availability Notification to the DSS/Order Filler and may be configured to also send it to other actors
- 10340 described in this transaction.
- The DSS/Order Filler, Post-Processing Manager or the Report Manager shall understand that the receipt of this notification message implies that the referenced instances are available at the Image Manager/Image Archive that is identified by the Retrieve AE Title attribute.
- 10345 Due to transient error conditions (e.g., corrupted storage media, Query/Retrieve SCP not running) that may occur within the Image Manager/Image Archive, an actor may not be able to retrieve instances for which it has received availability notifications. If an actor is uncertain about the availability status of instances referenced by the Instance Availability Notification, it can use the Image Availability Query [RAD-11] transaction to confirm the status as a supplementary method. Additionally, the Image Manager/Image Archive is assumed to be able to
- 10350 handle exceptions in instance storage or provision internally, based on local policy.

#### 4.49.4.1.2.1 Intentionally Left Blank

#### 4.49.4.1.3 Expected Actions

10355 The Department System Scheduler/Order Filler, Post-Processing Manager and Report Manager shall act as an Instance Notification SOP Class SCP. As a result of receiving the notification, the Department System Scheduler/Order Filler (or other actors) shall take appropriate action knowing that the referenced instances are available for further use in the workflow. Examples of such actions can be:

- The Department System Scheduler/Order Filler updates the procedure status internally, indicating that images for the procedure have been stored.
- 10360 • The Post-Processing Manager adds items to a corresponding worklist.
- The Report Manager adds items to a corresponding worklist.

The Report Manager adds items to a list of relevant priors for use within Reporting.

### 4.50 Store Instances [RAD-50]

#### 4.50.1 Scope

10365 In the Store Instances transaction, the Export Selector sends the selected composite instances to the Export Manager.

#### 4.50.2 Actor Roles

**Actor:** Export Selector

**Role:** Transmit instances to Export Manager.

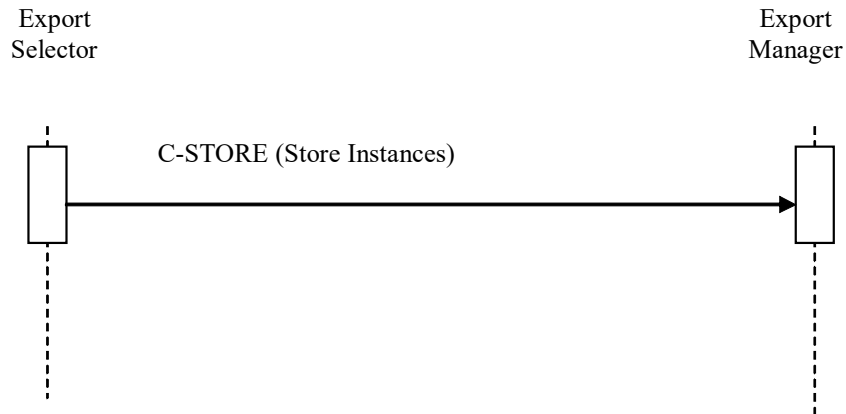
10370 **Actor:** Export Manager

**Role:** Accept instances from Export Selector and queue them for de-identification, pseudonymization and export

#### 4.50.3 Referenced Standard

DICOM [PS3.4 Annex B](#): Storage Service Class.

10375 **4.50.4 Messages**



**Figure 4.50.4-1: Interaction Diagram**

**4.50.4.1 Store Instances**

**4.50.4.1.1 Trigger Events**

10380 The Export Selector can transfer instances to the Export Manager sequentially within one or more DICOM associations.

**4.50.4.1.2 Message Semantics**

The Export Selector uses the DICOM C-STORE message to transfer the instances. The Export Selector is the DICOM Storage SCU and the Export Manager is the DICOM Storage SCP.

10385 **4.50.4.1.3 Expected Actions**

The Export Manager will queue the received DICOM objects, until ready to process them.

The DICOM Standard defines a number of composite storage SOP classes. The Export Manager shall support at least one composite storage SOP class, such as Images (see Table 4.8-1 for suggestions), Evidence Documents, Structured Reports, Presentation States and Radiotherapy objects.

10390

**4.51 Store Export Selection [RAD-51]**

**4.51.1 Scope**

In the Store Export Selection transaction, the Export Selector sends a Key Object Selection document acting as a manifest of a collection of selected composite instances to the Export Manager.

10395

### 4.51.2 Actor Roles

**Actor:** Export Selector

**Role:** Transmit manifest to Export Manager.

**Actor:** Export Manager

10400 **Role:** Accept manifest from Export Selector and queue the manifest and the referenced composite instances for processing (de-identification, pseudonymization and export)

### 4.51.3 Referenced Standard

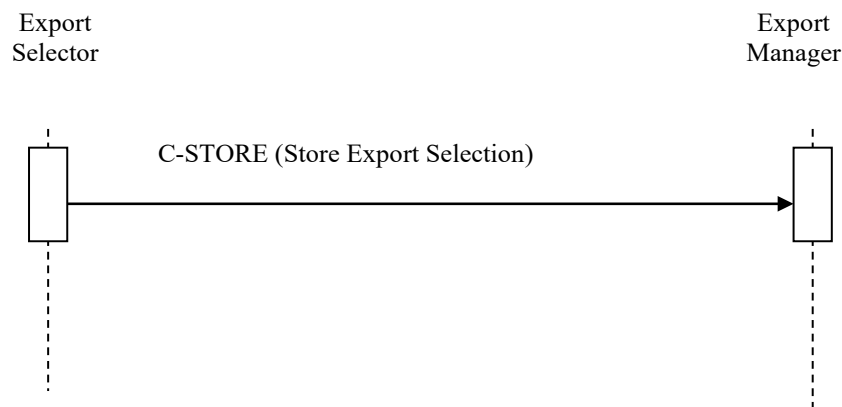
DICOM [PS3.4 Annex B](#): Storage Service Class.

DICOM [PS3.15 Section E.2](#): Basic Application Level Confidentiality Profile.

10405 DICOM [PS3.3](#): Information Object Definitions

DICOM [PS3.16](#): Content Mapping Resource

### 4.51.4 Messages



**Figure 4.51.4-1: Interaction Diagram**

10410 **4.51.4.1 Store Export Selection**

#### 4.51.4.1.1 Trigger Events

The Export Selector can transfer a manifest to the Export Manager with a DICOM association.

The timing of the transfer is not coupled to the timing of any Store Instances transaction, in that they may occur over the same or different associations, and the manifest may be received before, during or after the instances referred to by the manifest.

10415

#### 4.51.4.1.2 Message Semantics

The Export Selector uses the DICOM C-STORE message to transfer the manifest. The Export Selector is the DICOM Storage SCU and the Export Manager is the DICOM Storage SCP.

10420 The manifest (Export Selection) is an instance of the Key Object Selection SOP Class constructed according to the template defined in Table 4.51.4-1, which is a specialization of DICOM [PS3.16 TID 2010](#), and is itself non-extensible.

**Table 4.51.4-1: Export Selection (“Manifest”) Template – Specializes DICOM TID 2010**

	NL	Rel with parent	Value Type	Concept Name	VM	Req Type	Cond	Value Set Constraint
1			CONTAINER	EV (TCE001, IHERADTF, “For Teaching File Export”) or (TCE002, IHERADTF, “For Clinical Trial Export”) or (TCE007, IHERADTF, “For Research Collection Export”) or (TCE008, IHERADTF, “For Publication Export”)	1	M		Root node
2	>	HAS CONCEPT MOD	CODE	EV (113011, DCM, “Document Title Modifier”)	1	U		See Table 4.51.4-2 Delay Reason Values
3	>	HAS CONCEPT MOD	INCLUDE	DTID(1204) Language of Content Item and Descendants	1	U		
4	>	HAS OBS CONTEXT	INCLUDE	DTID (1002) Observer Context	1-n	U		
5	>	CONTAINS	TEXT	EV(113012, DCM, ”Key Object Description”)	1	U		Disposition
6	>	CONTAINS	IMAGE	Purpose of Reference shall not be present	1-n	MC	At least one of Rows 6 or 7 shall be present.	
7	>	CONTAINS	COMPOSITE	Purpose of Reference shall not be present	1-n	MC	At least one of Rows 6 or 7 shall be present.	

10425 The Document Title shall be either (TCE001, IHERADTF, “For Teaching File Export”) or (TCE002, IHERADTF, “For Clinical Trial Export”) or (TCE007, IHERADTF, “For Research Collection Export”) or (TCE008, IHERADTF, “For Publication Export”).

The Key Object Description TEXT content item, if present, shall describe the disposition of the selection. The use of this value requires coordination between the Export Selector and the Export Manager that is beyond the scope of this transaction to define.

- 10430
  - In the case of teaching files, this value could contain the identifier of a user to whom the case is to be routed for authoring, or it could be more generic and reference a role, a department, or a category of teaching file.
  - In the case of clinical trials, this value could contain the identifier of clinical trial protocol, and may affect behavior of the Remap Identifiers Option.
- 10435
  - In the case of research collections, this value could contain the identifier of a research collection.

A single Document Title Modifier content item may be present and specify a value that may be one of those listed in Table 4.51.4-2.

**Table 4.51.4-2: Delay Reason Values**

Coding Scheme Designator	Code Value	Code Meaning
IHERADTF	TCE011	Delay export until final report is available
IHERADTF	TCE012	Delay export until clinical information is available
IHERADTF	TCE013	Delay export until confirmation of diagnosis is available
IHERADTF	TCE014	Delay export until histopathology is available
IHERADTF	TCE015	Delay export until other laboratory results is available
IHERADTF	TCE016	Delay export until patient is discharged
IHERADTF	TCE017	Delay export until patient dies
IHERADTF	TCE018	Delay export until expert review is available

10440

No additional information describing the collection of referenced instances is contained in the manifest. Any such additional content, such as pre-formatted information to be conveyed to the teaching file authoring system, may be conveyed in separate SR documents referenced by the manifest; see Section 4.52 Store Additional Teaching File Information.

10445

The manifest shall not contain references to Additional Teaching File Information alone; hence any SR documents containing Additional Teaching File Information shall be referenced by the original export selection, and may not be added or sent in a separate manifest.

10450

Note that if the manifest does not include the DICOM [TID 1003](#) Person Observer Identifying Attributes within the DICOM [TID 1002](#) Observer Context, then it will not be possible to identify which individual assembled the collection. Accordingly, it may not be possible for the Export Manager and subsequent actors to route the collection to that individual, other than as specified by the disposition encoded in the Key Object Description TEXT content item.

Only instances of a single patient may be referenced by the manifest, but there may be instances of multiple studies.

10455

A common use-case involving multiple studies occurs when the selection references current and prior images. When the selection references more than one study, DICOM requires that multiple

instances of the Key Object Selection Document be created, one for each Study Instance UID and cross-referenced by the Identical Documents Sequence (see DICOM [PS3.3 Section C.17.6.2.1](#)). IHE therefore requires that there be multiple copies of the same manifest sent in this transaction, one for each study.

#### **4.51.4.1.3 Expected Actions**

The Export Manager will queue the manifest until it has received all DICOM instances referenced therein, and is ready to process them.

The instances shall not be processed until the manifest has been received, since it dictates the form of processing required. The Delay for Reason Option may require the processing to be further delayed; see Section 4.51.4.1.5.

Note that in the case of multiple manifests to handle the multiple study case, since the lists of referenced instances therein are identical, the Export Manager need not wait until all copies of the manifest have been received before commencing processing. In the multiple study case, receipt of only a single manifest shall not be considered as an error condition and normal processing shall occur. The Export Manager shall examine the Identical Documents Sequence in each manifest to detect the multiple study case and to prevent the same export from being repeated.

No export shall be performed if instances are received but no referencing manifest is received within a configurable time.

If all the instances in the manifest are not received within a configurable time, the Export Manager shall proceed with an incomplete set and create an updated manifest. If the missing instances are received later, either they shall not be exported or a separate export and manifest shall be exported containing only those instances.

Instances referenced by the manifest may be of a SOP Class not supported by the Export Manager as a Storage SCP and hence will never be received. The SOP Class UIDs are encoded in the manifest. The Export Manager shall proceed with an incomplete set and create an updated manifest.

If the Export Manager is grouped with an Image Manager/Archive and already has all referenced DICOM instances, it may begin processing upon receipt of the manifest.

The Export Manager shall de-identify and pseudonymize all the DICOM instances referenced by the manifest, as defined in Section 4.51.4.1.4, before forwarding them all by initiating Export Instances [RAD-53] transactions.

#### **4.51.4.1.4 De-identification and Pseudonymization**

##### **4.51.4.1.4.1 Baseline De-identification and Pseudonymization Requirements**

There is considerable variation in what attributes need to be removed to achieve sufficient de-identification and pseudonymization for any particular purpose. See the discussion in RAD TF-2x: Appendix I.1.



10495 Accordingly, this transaction does not require the removal of all text attribute values, nor the removal of all private attribute values.

10500 Rather, it requires that the implementation provide a mechanism to allow the user to configure those attributes that will be removed or replaced. The transaction requires that at minimum, the implementation support the ability to configure the use of the Basic Application Level Confidentiality Profile in DICOM [PS3.15 Section E.2](#). Further, it shall be configurable to perform no de-identification at all.

When de-identification has been performed, the Export Manager shall add to the DICOM dataset of each instance the Patient Identity Removed (0012,0062) attribute with a value of YES.

10505 In some scenarios, it will be desirable to configure the Export Manager to perform no de-identification at all, such as when all de-identification will be performed in the Teaching File Receiver, or not at all. In such cases, if the Patient Identity Removed (0012,0062) attribute is present in the dataset it shall not be changed; if it is absent it shall not be added.

10510 In some de-identification scenarios, the UIDs need to be replaced. This transaction does not require that UIDs be replaced, but does require that if UIDs are replaced, internal consistency within the exported set of instances be maintained; the implementation shall be configurable to support both. This entails adherence to the following rules:

- The same replacement UID is used for all composite instances of the same entity within the set, e.g., the same Study Instance UID for all instances within the same original study.
- References by UID to other instances or entities within the set are updated, e.g., references to the SOP Instance UIDs of predecessor documents, reference images and source images.
- References by UID to other instances or entities not included within the set are removed or replaced with consistent, well-formed, dummy references.

10520 If the same instances are exported multiple times on different occasions, the identifying attributes and UIDs therein may or may not be replaced with the same values on each occasion. That is, this transaction does not require deterministic behavior for replacement of identifying attributes and UIDs, except as specified for the Remap Identifiers Option. See also the discussion in RAD TF-2x: Appendix I.2.

The actions of the de-identification and pseudonymization must not create invalid IODs. Specifically:

- Mandatory and conditional attributes may not be removed, but rather must be replaced.
- Type 1 attributes must be given a value.
- Type 2 attributes may be encoded zero length, but it is often advisable to encode a value, especially for attributes likely to be used in browsers such as Patient Name, Patient ID, Study ID and Accession Number.

10530 **4.51.4.1.4.2 Manifest Coercion**

The manifests received from the Export Selector will be Key Object Selection Documents that references instances of a single patient, but possibly from multiple studies. If multiple studies are referenced there will be multiple copies of the Key Object Selection Document.

10535 The manifest(s) will contain the original identifying information, and hence need to undergo de-identification and pseudonymization prior to export, in accordance with the same requirements as the instances to which it refers.

The Export Manager shall update the UIDs in the references in the manifest(s) to the studies, series and instances, if the UIDs in the referenced instances have been changed.

10540 If the Export Manager has not received all the instances in the set referenced by the manifest(s), and will not transmit them to the Receiver, then they shall be removed from the forwarded manifest(s).

Any Document Title Modifier specifying a Delay for Reason shall be removed.

A manifest shall always be included in the export from the Export Manager to the Receiver.

10545 In the multiple study case, the correct number of manifests shall be exported to the Receiver, regardless of what was received from the Export Selector.

**4.51.4.1.4.3 Remap Identifiers Option**

The purpose of this option and its requirements are described in RAD TF-1: 17.2.2. The DICOM Clinical Trials attributes are further discussed in RAD TF-2x: Appendix I.3.

10550 Table 4.51.4-3 below lists the attributes that shall be used as keys to select which values to use for remapping of identifiers, and which attributes shall be replaced.

If the same instances are exported multiple times, the attributes in Table 4.51.4-3 shall be remapped to the same values. Other attributes, including UIDs, may or may not be replaced with the same values on each occasion. That is, this option only requires deterministic behavior for the attributes in Table 4.51.4-3.

10555 Table 4.51.4-3 uses the following conventions:

- M – Match means that the attribute is used as the key value to match at the specified level, and hence to select new values for mapping other attributes at that level
- C – Change means that any value shall be replaced by a non-zero value, or the attribute shall be inserted with a value if not present
- 10560 • D – Deletion means either removal of the attribute if it is Type 3, or replacement with zero length if it is Type 2, or replacement with a dummy value if it is Type 1
- L – Leave means do not change the existing value of the attribute

**Table 4.51.4-3: Remap Identifiers Option Attributes**

Attributes Name	Tag	Match	Delete, Change or Leave	Notes
<b>Clinical Trial Protocol Level</b>				
Clinical Trial Protocol ID	(0012,0020)		C	Note 1
<b>Clinical Trial Site Level</b>				
Institution Name	(0012,0020)	M	C	Note 2
Clinical Trial Site ID	(0012,0030)		C	
<b>Clinical Trial Subject Level</b>				
Patient ID	(0010,0020)	M	C	Note 2
Patient Name	(0010,0010)		C	Note 2
Other Patient IDs	(0010,1000)		D	
Patient's Birth Date	(0010,0030)		L or C or D	Note 4
Patient's Age	(0010,1010)		L or C or D	Note 4
Patient's Sex	(0010,0040)		L or C or D	Note 4
Clinical Trial Subject ID	(0012,0040)		C	
<b>Clinical Trial Study Level</b>				
Study Date	(0008,0020)	M	L or C	Notes 3, 4
Study Time	(0008,0030)		L or C	Notes 3, 4
Study Description	(0008,1030)		L or C	Note 4
Clinical Trial Timepoint ID	(0012,0050)		C	
Accession Number	(0008,0050)		D	
<b>Clinical Trial Series Level</b>				
Series Description	(0008,103E)	M	L or C	Note 4
Series Number	(0020,0011)		L or C	Note 4

10565

Note 1: No matching of the Clinical Trial Protocol level based on attributes in the instances is specified, since the clinical trial protocol that is the target of the export will be conveyed in the disposition specified in the manifest.

10570

Note 2: The delete option is not provided for these attributes; replacement is required. This is because these attributes are important for the correct operation of conventional databases and browsers, hence null or dummy values are not acceptable. Typically, for example, the same value inserted in Clinical Trial Subject ID will also be duplicated in Patient ID and Patient Name. Likewise, the same value inserted in Clinical Trial Site ID will also be duplicated in Institution Name.

Note 3: Whether or not the Study Date and Time need to be left or replaced depends on the requirements of the clinical trial; the implementation shall support both.

Note 4: The presence of more than one option means that the application shall be configurable to allow for any of the options.

10575

#### **4.51.4.1.4.4 De-identify Pixel Data Option**

The removal of identifying information that is burned into the pixel data of single or multi-frame images is a non-trivial task. With image sources from multiple modalities and multiple vendors it is difficult to predict *a priori* within which pixels such identification is contained. Hence this task

10580 is difficult to automate and in the majority of instances requires intervention by a human operator acting through a user interface with what is essentially a pixel data editor.

An Export Manager claiming this option shall provide a method of de-identification of the pixel data. The manner in which this is performed is not specified. De-identification is generally considered successful if patient-identifying information can no longer be read or recovered from the pixel data.

10585 Whether or not de-identification of the pixel data of a particular image is required may be difficult to determine, and may require human intervention. This option requires that the Export Manager provide a mechanism for categorizing those images that are at risk, and requiring confirmation by a human operator that the identification has been removed.

10590 If an instance already contains the Burned In Annotation (0028,0301) attribute with a value of NO, then pixel data de-identification is not required. When de-identification of pixel data has been performed, the Export Manager shall add to the DICOM dataset of each instance the Burned In Annotation (0028,0301) attribute with a value of NO.

This option neither requires nor prohibits changing the SOP Instance UIDs; the implementation shall be configurable to support both.

#### 10595 **4.51.4.1.4.5 De-identification of Non-Image Instances**

10600 There are no specific requirements or named options for the removal of identification information that may be contained within the payload of non-image instances. For example, an SR object that contains a plain text report or an evidence document, or an encapsulated PDF document, could contain identifying information within the payload that is difficult to detect and remove in an automated manner, and operator intervention may be required. It is beyond the scope of this profile to define the mechanisms for the removal of such information. It suffices to say that the subset of DICOM composite storage SOP instances supported by the Export Manager as an SCP should take this factor into consideration.

#### **4.51.4.1.5 Delay for Reason**

10605 When the Exporter supports the Delay for Reason Option, and the Document Title Modifier of a manifest specifies a coded reason for delay, and the Exporter supports that coded reason, then processing shall not begin until the reason for the delay has been satisfied, or the delay condition is not satisfied within a configurable time.

### **4.52 Store Additional Teaching File Information [RAD-52]**

#### 10610 **4.52.1 Scope**

In the Store Additional Teaching File Information transaction, the Export Selector sends an SR document containing additional teaching file information to the Export Manager.

#### **4.52.2 Actor Roles**

**Actor:** Export Selector

10615 **Role:** Transmit information to Export Manager.

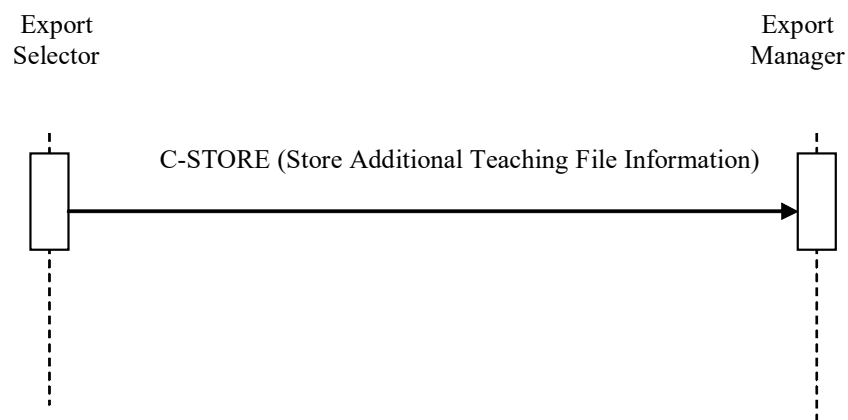
**Actor:** Export Manager

**Role:** Accept information from Export Selector and queue it for de-identification, pseudonymization and export

#### 4.52.3 Referenced Standard

10620 DICOM [PS3.4 Annex B](#): Storage Service Class.

#### 4.52.4 Messages



**Figure 4.52.4-1: Interaction Diagram**

#### 4.52.4.1 Store Additional Teaching File Information

##### 10625 4.52.4.1.1 Trigger Events

The Export Selector can transfer information to the Export Manager sequentially within one or more DICOM associations.

The timing of the transfer is not coupled to the timing of any Store Instances or Store Export Selection transactions, in that they may occur over the same or different associations, and the manifest may be received before, during or after the instances referred to by the manifest.

10630

##### 4.52.4.1.2 Message Semantics

The Export Selector uses the DICOM C-STORE message to transfer the additional information encoded as one or more Enhanced SR SOP Class instances. The Export Selector is the DICOM Storage SCU and the Export Manager is the DICOM Storage SCP.

10635 This information is separate from the manifest summarizing the collection of referenced instances is contained.

More than one instance may be present.

To be included in the material to be exported, the instances of this transaction must be referenced by the manifest(s) in the Store Export Selection transaction.

10640 The Document Title shall be (TCE006, IHERADTF, “Additional Teaching File Information”).

An example template for an SR describing a typical Radiology Teaching File collection is described in RAD TF-2x: Appendix H.

#### **4.52.4.1.3 Expected Actions**

The Export Manager will queue the received DICOM objects, until ready to process them.

### **10645 4.53 Export Instances [RAD-53]**

#### **4.53.1 Scope**

10650 In the Export Instances transaction, the Export Manager sends the de-identified and pseudonymized composite instances and a Key Object Selection document acting as a manifest of the collection to a Receiver. The purpose of the manifest is to retain the information that the referenced instances constitute the collection that it is being exported.

#### **4.53.2 Actor Roles**

**Actor:** Export Manager

**Role:** Transmit de-identified and pseudonymized instances and manifest to Receiver.

**Actor:** Receiver

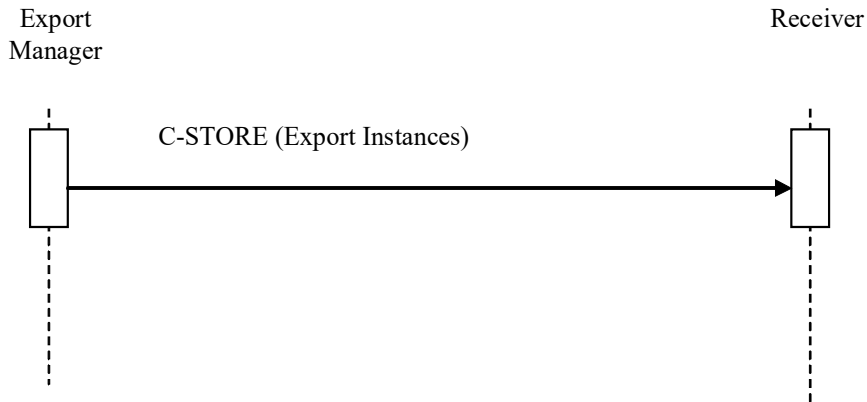
10655 **Role:** Accept instances from the Export Manager

#### **4.53.3 Referenced Standard**

DICOM [PS3.4 Annex B](#): Storage Service Class

DICOM [PS3.3 Section A.35.4](#): Key Object Selection Document IOD

### 4.53.4 Messages



10660

**Figure 4.53.4-1: Interaction Diagram**

#### 4.53.4.1 Export Instances

##### 4.53.4.1.1 Trigger Events

10665 The Export Manager initiates this transaction when it has de-identified and pseudonymized all the instances referenced within an Export Selection, as well as any instances of Additional Teaching File Information and the manifest.

##### 4.53.4.1.2 Message Semantics

10670 The Export Manager uses the DICOM C-STORE message to transfer the instances and the manifest. The Export Manager is the DICOM Storage SCU and the Receiver is the DICOM Storage SCP.

The Export Manager can transfer the instances and the manifest to the Receiver within one or more DICOM associations.

10675 The timing of the transfer of the manifest and the instances to which it refers is not defined, in that they may occur over the same or different associations, and the manifest may be received before, during or after the instances referred to by the manifest.

The manifest is an instance of the Key Object Selection SOP Class.

##### 4.53.4.1.3 Expected Actions

A receiver shall support the Key Object Selection SOP Class as an SCP.

10680 The Receiver may support any composite storage SOP class, including Images, Evidence Documents, Structured Reports, Presentation States, and Radiotherapy objects.

If the Receiver does not support all the SOP Classes of the instances to be exported, then the transfer will partially or completely fail.

10685 A Receiver claiming the Additional Teaching File Information Option shall be able to receive Enhanced SR SOP Class instances. No specific semantics are defined for receipt of the Additional Teaching File Information.

Unless grouped with other actors, the further behavior of the Receiver on receiving the instances and manifests is beyond the scope of the transaction to define. Typically:

- In the case of teaching files, such a device might store the received instances whilst awaiting a manifest prior to queuing the instances for authoring by the user.
- 10690 • In the case of clinical trials, such a device might store the received instances whilst awaiting a manifest prior to queuing for entry into the clinical trial workflow

A Receiver grouped with an Image Manager/Archive shall make the received instances available for use in the normal manner as defined by other Profiles. If the Image Manager/Archive claims the Key Image Note Profile, then the manifests shall be made available as Key Image Notes.

10695 A Receiver grouped with a Portable Media Creator shall store the received instances whilst awaiting a manifest prior to burning the referenced instances and manifests to media, as defined by the requirements in the Portable Data for Imaging Profile.

#### **4.54 Provide and Register Imaging Document Set – DEPRECATED**

10700 This transaction has been deprecated and is superseded by the Provide and Register Imaging Document Set – MTOM/XOP [RAD-68] as part of the Cross-Enterprise Document Sharing for Imaging (XDS-I.b) Profile.

#### **4.55 WADO Retrieve [RAD-55]**

##### **4.55.1 Scope**

10705 The WADO Retrieve transaction enables an Imaging Document Consumer to access DICOM SOP Instances with a web-based service through HTTP/HTTPS protocol.

##### **4.55.2 Actor Roles**

**Actor:** Imaging Document Consumer

**Role:** Issues an HTTP Get Request to access a DICOM instance.

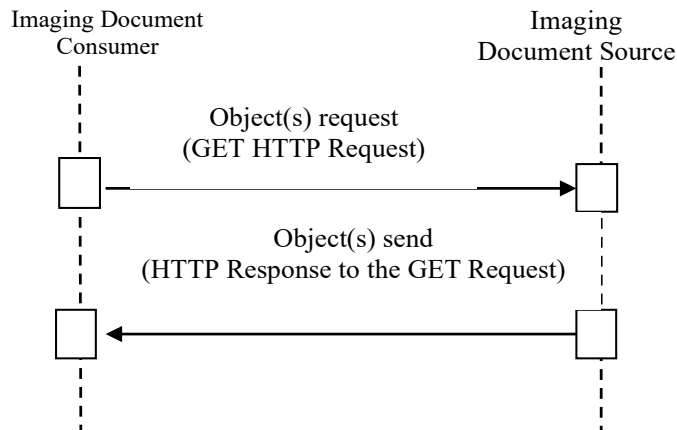
**Actor:** Imaging Document Source

10710 **Role:** Receives an HTTP Get Request for accessing a DICOM instance and generates the HTTP response with the appropriate content.

##### **4.55.3 Referenced Standard**

DICOM [PS3.18 Section 10.4](#): Web Services - Retrieve Transaction of the DICOM Studies Service (also known as Web Access to DICOM Persistent Objects (WADO))



10715 **4.55.4 Messages****Figure 4.55.4-1: Interaction Diagram****4.55.4.1 WADO Retrieve**

10720 The Imaging Document Consumer issues an HTTP Get to request a specific DICOM instance from the Imaging Document Source. The Imaging Document Source receives the request, generates the response with the appropriate content and sends an HTTP Response to the Imaging Document Consumer.

**4.55.4.1.1 Trigger Events**

10725 The Imaging Document Consumer wishes to retrieve a DICOM instance that is referenced within a DICOM Manifest.

**4.55.4.1.2 Message Semantics**

The message semantics are defined by in DICOM [PS3.18 Section 10.4](#).

10730 The WADO Retrieve transaction is performed by the Imaging Document Consumer to send a HTTP Request-URI to the web server of the Imaging Document Source. The Imaging Document Consumer generates the HTTP Request-URI to retrieve a DICOM instance. The DICOM instance shall be specified with its Study Instance UID, Series Instance UID, and SOP Instance UID in the HTTP Request-URI. The Imaging Document Consumer must obtain the host information (e.g., web server location, and script language) of the web server to perform this transaction. The Imaging Document Consumer can map the Retrieve AE Title of the SOP Instance to the web server host information based on its local configuration (see RAD TF-2x: Appendix G).

10735

In addition, the Imaging Document Consumer shall support the following fields in the HTTP request:

**Table 4.55-1: WADO HTTP Request Fields**

HTTP Field	REQ	Description	Values
Accept	R	This field is used to specify MIME types which are acceptable for the response	At least one of the following values: application/dicom image/jpeg application/text application/html */* Other values may be included as well
Accept-Language	O	This field specifies the language of the object to be retrieved.	Any valid value according to RFC2616

10740 The Imaging Document Source shall list all media types it supports in the Accept field of the HTTP request, and shall use WADO HTTP parameter contentType to request the desired media type of the object to be retrieved in the HTTP response (see Table 4.55-2).

The Imaging Document Source and the Imaging Document Consumer are required to support a number of parameters in the WADO HTTP Request-URI, as described in the following table.

10745

**Table 4.55-2: WADO HTTP Request Parameters**

Parameter Name	Parameter Description	Requirement		Note
		Imaging Document Source	Imaging Document Consumer	
requestType	Type of the HTTP request performed. It must be "WADO"	R	R	
studyUID	Unique identifier of the study	R	R	
seriesUID	Unique identifier of the series	R	R	
objectUID	Unique identifier of the object	R	R	
contentType	MIME type of the response	R+	R+	IHE-1 IHE-2
charset	Charset of the response	O	O	
anonymize	Anonymize object	O	O	
annotation	Annotation of the object	O	O	IHE-3
rows	Number of pixel rows	O	O	IHE-3
columns	Number of pixel columns	O	O	IHE-3
region	Region of image	O	O	IHE-3
windowCenter	Window center of the image	O	O	IHE-3
windowWidth	Window width of the image	O	O	IHE-3
frameNumber	Frame number of the single frame in a multi-frame image	O	O	IHE-3
imageQuality	Image quality factor	O	O	IHE-3
presentationUID	Unique identifier of the presentation object	O	O	IHE-3

Parameter Name	Parameter Description	Requirement		Note
		Imaging Document Source	Imaging Document Consumer	
presentationSeriesUID	Unique identifier of the series containing the presentation object	O	O	IHE-3
transferSyntax	Transfer syntax UID used with DICOM image object returned in the response	O	O	IHE-3

IHE-1: The Imaging Document Consumer must use the value “application/dicom” to retrieve a DICOM SOP Instance in the DICOM Part 10 File Format. This allows the Imaging Document Consumer to receive a SOP Instance in the native DICOM format for full data manipulation.

10750

The Imaging Document Consumer can also use the value “application/jpeg” to retrieve an image encoded in JPEG baseline format if it is a single frame DICOM image object or a single frame image encoded in a multi-frame DICOM image object.

The Imaging Document Consumer can also use the values “application/text” or “application/html” to retrieve a DICOM SR object represented in the text or html format.

10755

The Imaging Document Consumer can also use other values for this parameter as specified in DICOM PS3.18, if they are supported by the Imaging Document Source.

This parameter is optional in DICOM PS3.18. Because the default format of the DICOM persistent object returned in the HTTP Get response in the absence of a value in this parameter varies depending on the SOP Class of the retrieved object, this transaction requires that the parameter be supported, to improve interoperability.

10760

IHE-2: This parameter must be compatible to the value(s) that the Imaging Document Consumer placed in the Accept field of the HTTP Request-URI.

IHE-3: The parameter applies only to a DICOM SOP Instance if it is an image object.

#### 4.55.4.1.2.1 Example of WADO Request-URI

The following is an example of HTTP Request-URI for retrieving a persistent DICOM object using WADO:

10765

*http://www.hospital/radiology/wado.php?requestType=WADO&studyUID=1.2.250.1.59.40211.12345678.678910&seriesUID=1.2.250.1.59.40211.789001276.14556172.67789&objectUID=1.2.250.1.59.40211.2678810.87991027.899772.2&contentType=application%2Fdicom*

10770

This example uses response MIME type application/dicom to request the DICOM SOP Instance returned in the native DICOM Part 10 file format.

#### 4.55.4.1.3 Expected Actions

10775

Upon reception of the WADO HTTP Request, the Imaging Document Source shall parse the request and if there are no errors, shall construct an HTTP Get Response with the requested DICOM instance content and return the response as specified by the DICOM WADO standard, with HTTP response code 200 (OK).

The Imaging Document Source shall return HTTP response code 406 (Not Acceptable), if it cannot serve the requested response MIME type(s) in parameter contentType and/or Accept Field.

10780 The Imaging Document Source shall return HTTP response code 404 (Not Found) if it cannot locate the requested DICOM SOP Instance or cannot recognize the UID values specified in the received HTTP Request-URI.

10785 The Imaging Document Source shall return HTTP response code 400 (Bad Request) if any required HTTP field or required WADO HTTP parameters are missing in the received HTTP Request-URI, or any other syntactic error is detected in the HTTP Request-URI (e.g., media type in contentType parameter conflicts with media types in Accept field).

10790 The Imaging Document Source in the Imaging Object Change Management Integration Profile shall not return the rejected DICOM SOP Instance(s) referenced by the specific KOS instances with the Document Title valued (113001, DCM, “Rejected for Quality Reasons”), (113037, DCM, “Rejected for Patient Safety Reasons”), (113038, DCM, “Incorrect Modality Worklist Entry) or (113039, DCM, “Data Retention Policy Expired”). The Imaging Document Source shall return HTTP response code 404 (Not Found) if the Imaging Document Consumer requested retrieval of such rejected DICOM SOP Instance(s) referenced in that KOS.

#### **4.55.4.1.4 Audit Trail Trigger Events**

10795 IHE specifies a number of events that shall be reportable by means of the Record Audit Event [RAD-20] transaction ([ITI TF-2: 3.20](#)) in the [ITI Audit Trail and Node Authentication \(ATNA\)](#) Profile. The [Radiology Audit Trial](#) Option further defines a subset of these events, which are particularly applicable to the radiology transactions.

See RAD TF-3: Table 5.1-2 for audit events required for the [RAD-55] transaction.

#### **4.56 Spatial Registrations Stored [RAD-56]**

10800 This transaction is currently in the [Image Fusion](#) (FUS) Trial Implementation Supplement.

#### **4.57 Blending Presentation States Stored [RAD-57]**

This transaction is currently in the [Image Fusion](#) (FUS) Trial Implementation Supplement.

#### **4.58 Retrieve Spatial Registrations [RAD-58]**

This transaction is currently in the [Image Fusion](#) (FUS) Trial Implementation Supplement.

10805 **4.59 Import Procedure Step In Progress [RAD-59]**

##### **4.59.1 Scope**

This transaction includes a message from the Importer to the Performed Procedure Step Manager, which in turn issues the message to the Department System Scheduler/Order Filler, the Image Manager and the Report Manager that the Performed Procedure Step is in progress.

10810 The receiving Performed Procedure Step Manager is grouped with the Image Manager or the Department System Scheduler/Order Filler, and shall support forwarding messages to two other

destinations besides the actor it is grouped with. It shall start issuing messages to the configured destinations immediately after it accepts the corresponding messages from the Importer.

To allow for proper integration, the following considerations must be taken into account:

- 10815 The Performed Procedure Step Manager must maintain PPS objects and then store them until corresponding N-CREATE and N-SET messages are transmitted to the actor it is grouped with, and the two other actors. If transmission to a destination fails, the Performed Procedure Step Manager shall try to repeat transmission periodically until it succeeds. The Performed Procedure Step Manager must not use failure of one or more of these transmissions as a reason for rejecting the initial transmission from the Importer.
- 10820

Because both the Image Manager and the Department System Scheduler/Order Filler incorporate the Performed Procedure Step Manager function, an infinite redistribution of PPS messages is possible. The Image Manager and the Department System Scheduler/Order Filler systems that provide the Performed Procedure Step Manager function shall be configurable to disable this function;

10825

Transfer of the information to the system that the receiving Performed Procedure Step Manager is integrated with is outside the scope of the IHE Radiology Technical Framework (i.e., internal to an implementation).

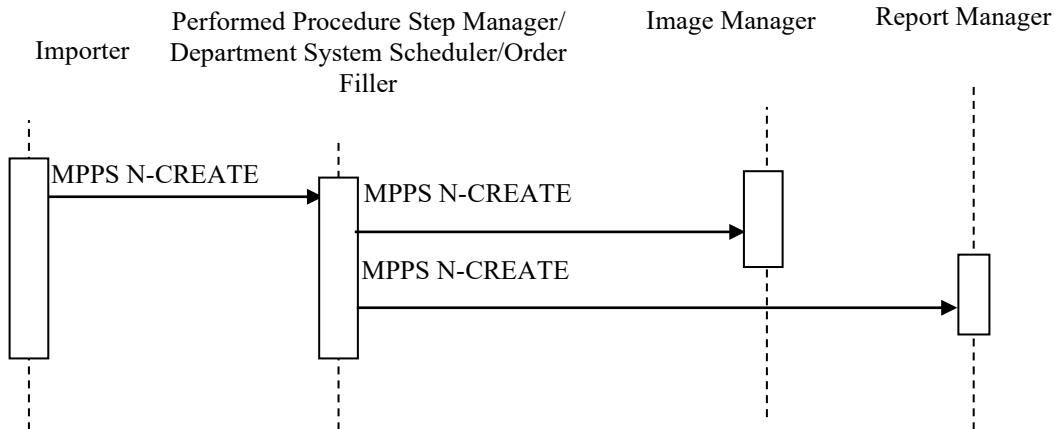
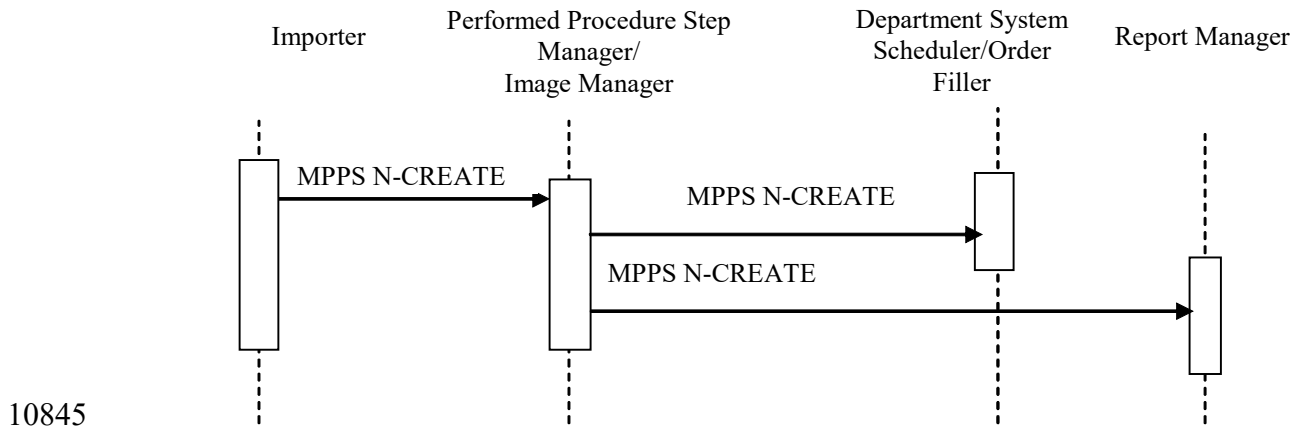
#### 4.59.2 Actor Roles

- 10830 **Actor:** Department System Scheduler/Order Filler.  
**Role:** Receives the PPS information forwarded by the PPS Manager.  
**Actor:** Image Manager.  
**Role:** Receives the PPS information forwarded by the PPS Manager.  
**Actor:** Report Manager.
- 10835 **Role:** Receives the PPS information forwarded by the PPS Manager.  
**Actor:** Importer.  
**Role:** Informs the Performed Procedure Step Manager that a particular Performed Procedure Step has started.  
**Actor:** Performed Procedure Step Manager.
- 10840 **Role:** Accepts Performed Procedure Step information from an Importer and transmits it to the Department System Scheduler/Order Filler, Image Manager and Report Manager.

#### 4.59.3 Referenced Standards

DICOM [PS3.4 Section F.7](#): Modality Performed Procedure Step SOP Class.

**4.59.4 Messages**



**Figure 4.59.4-1: Interaction Diagram**

**4.59.4.1 Procedure Step In Progress Message**

10850 **4.59.4.1.1 Trigger Event**

The User begins the import procedure step from the Importer.

**4.59.4.1.2 Message Semantics**

10855 The Importer importing Evidence Objects into the Enterprise uses a Modality Performed Procedure Step SOP Class (N-CREATE Service) to inform the Performed Procedure Step Manager that a specific Procedure Step has been started and is in progress. In turn, the Performed Procedure Step Manager uses the N-CREATE service to forward the information to the Department System Scheduler/Order Filler, Image Manager and Report Manager. The Performed Procedure Step Manager shall use the same Performed Procedure Step SOP Instance UIDs during this interchange. The following aspects shall be taken into account during implementation

10860 of this step:

#### 4.59.4.1.2.1 Patient/Procedure/Scheduled Procedure Step Information

10865 The Importer shall ensure that the critical Patient information is valid and correct (see RAD TF-2x: Appendix A.5). Additionally, if a Procedure Step has been scheduled for the importation it is also necessary to validate the Procedure information. Due to the fact that the Evidence Objects or Hardcopy to be imported are not native to the Enterprise, the validation process (by the User) of ensuring that the correct Patient is associated with the imported data is critical.

#### 4.59.4.1.2.2 Required Attributes

10870 RAD TF-2x: Appendix A.5 lists a number of attributes that shall be coerced by the Importer to ensure consistency between the information included in the imported SOP instances, the Performed Procedure Step attributes, the Patient Demographic Information and the Scheduled Procedure Step information, if applicable.

#### 4.59.4.1.2.3 Relationship between Scheduled and Performed Procedure Steps and the Imported DICOM Composite Object

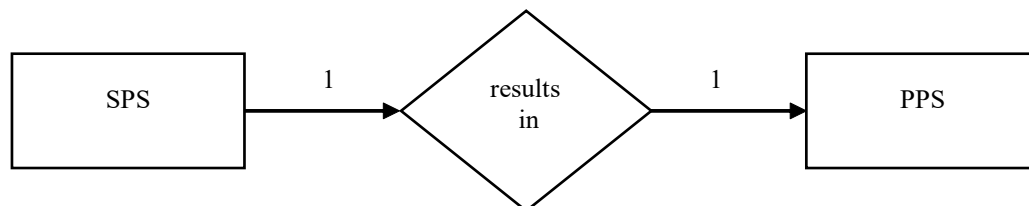
10875 When importing a DICOM Composite Object (e.g., from CD), the DICOM header information must either be preserved to ensure the integrity of the Study or coerced to fit within the local Enterprise. RAD TF-2x: Appendix A.5 defines specific coercion requirement. For example, the Study Instance UID is one of the elements which must be maintained.

10880 The original scheduling and performing of the studies to be imported is outside of the venue of the Enterprise. For this reason, the association of Evidence Objects from a study to be imported may have relationships which are not easily described.

When digitizing Hardcopy and creating a new DICOM Composite Object, some of the original patient and study details may be derived from manual entry, OCR, configuration, etc. or may not be available. RAD TF-2x: Appendix A.5 defines specific requirements.

10885 The relationship between Scheduled and Performed Procedure Step information for an importation is shown in the following 2 cases. Refer to RAD TF-2x: Appendix A.5 for details of filling other attributes (Procedure ID, Accession Number, etc.) in each of these cases. In each case a MPPS N-Create Message is sent to notify the system that the performed procedure import is in progress

#### 4.59.4.1.2.3.1 Scheduled Import Option



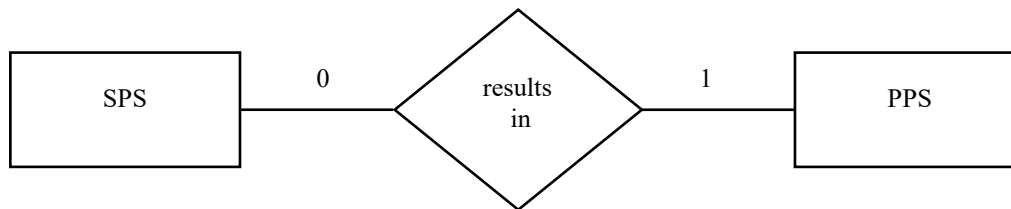
10890

In the Scheduled Import Option, the Scheduled Procedure Step information is provided by a Modality Worklist. There exists a 1-to-1 relationship between SPS and PPS. Information about the Scheduled Procedure Step and Requested Procedure shall be copied from the Scheduled

10895 Procedure Step object to the Performed Procedure Step Relationship Module (see RAD TF-2x: Appendix A.5).

Examples: A Procedure Step was performed exactly as scheduled. It could also be that a Procedure Step was not exactly performed as scheduled, but without being rescheduled, e.g., multiple Portable Media exist for a single Patient Study.

#### 4.59.4.1.2.3.2 Unscheduled Import Option



10900

In the Unscheduled Import Option the Importer does not receive Scheduled information. There is a 0-to-1 relationship between SPS and PPS. The Patient information is received through a Patient Demographics Query and no Scheduled Procedure Step or Requested Procedure information is available.

#### 10905 4.59.4.1.2.3.3 Performed Protocol Sequence for Import

The Performed Protocol Code Sequence (0040,0260) shall be present in the Import Modality Performed Procedure Step. It is used to provide information on how the import should be handled (e.g., Interpret the Evidence Objects, Destroy the associated Media).

10910 The Performed Protocol Code Sequence shall always contain one item with the value of (IRWF001, IHETFRAD, "Import").

In addition, if the Scheduled Protocol Code Sequence (0040,0008) exists, it shall be copied to the Performed Protocol Code Sequence (0040,0260), unless modified by the operator. For both the Scheduled and Unscheduled Import, the Importer may have the ability to add/modify the Import Instructions (see Table 4.5-4).

#### 10915 4.59.4.1.3 Expected Actions

The Department System Scheduler/Order Filler, Report Manager and the Image Manager/Image Archive receive information from the Performed Procedure Step Manager and in the scheduled case, link it with the Requested Procedure and Scheduled Procedure Step.

10920 How the Performed Procedure Step Manager, Department System Scheduler/Order Filler, Report Manager and the Image Manager/Image Archive uses the information contained within the Performed Protocol Sequence is currently undefined.



## 4.60 Import Procedure Step Completed/Discontinued [RAD-60]

### 4.60.1 Scope

10925 This transaction includes a message from the Importer to the Performed Procedure Step Manager, which forwards the messages to the DSS/Order Filler, the Report Manager and the Image Manager that the Performed Procedure Step and importation has been completed. The Image Manager may need the information to co-locate Evidence Objects of the same study. The Modality Procedure Step Completed message does not necessarily mean that the set of Evidence Objects is complete or available for retrieval.

### 10930 4.60.2 Actor Roles

**Actor:** Department System Scheduler/Order Filler.

**Role:** Receives the PPS information forwarded by the PPS Manager.

**Actor:** Image Manager.

**Role:** Receives the PPS information forwarded by the PPS Manager.

10935 **Actor:** Report Manager.

**Role:** Receives the PPS information forwarded by the PPS Manager.

**Actor:** Importer.

**Role:** Informs the Performed Procedure Step Manager that a particular Performed Procedure Step and Importation is completed.

10940 **Actor:** Performed Procedure Step Manager (PPS Manager)

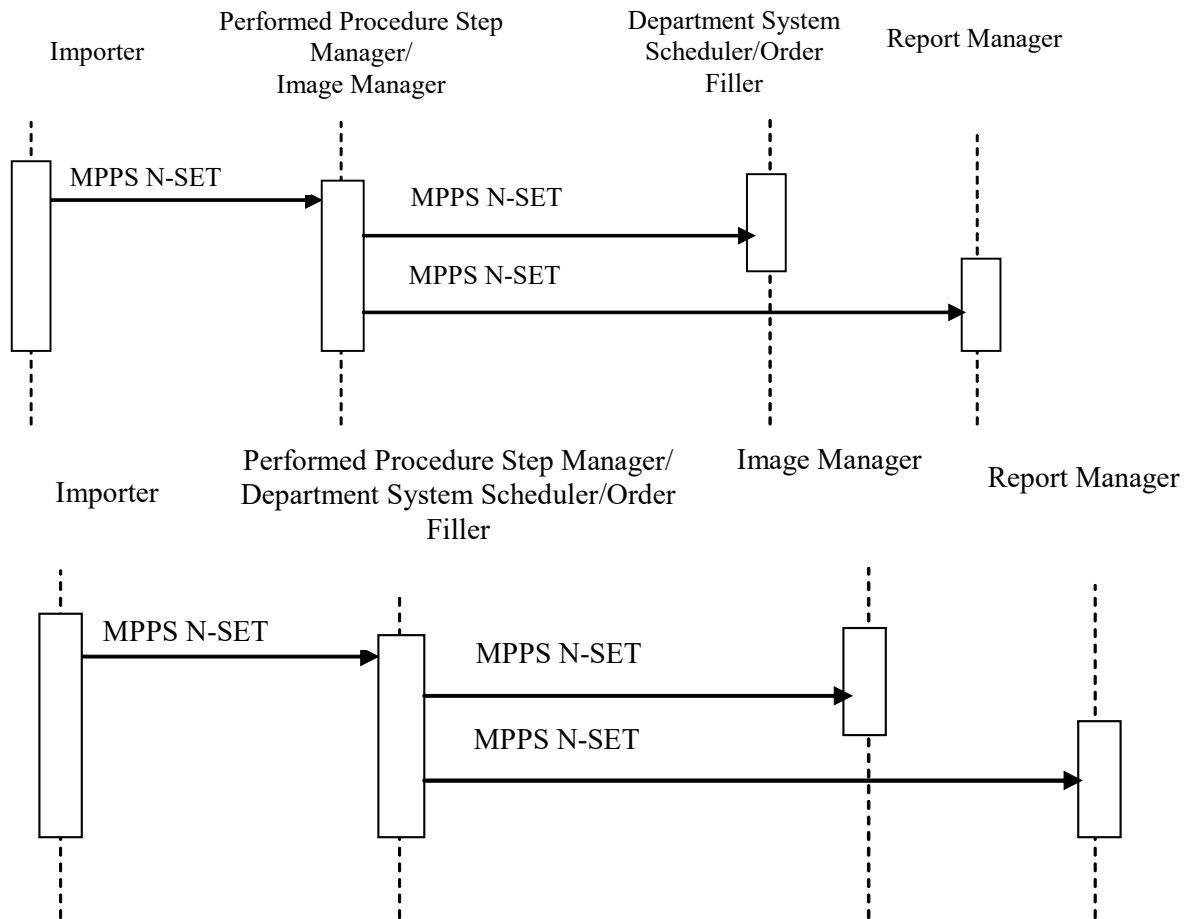
**Role:** Accepts Performed Procedure Step information from a Portable Media Importer or Evidence Creator and transmits it to the Department System Scheduler/Order Filler, Image Manager and Report Manager.

### 4.60.3 Referenced Standards

10945 DICOM [PS3.4 Section F.7](#): Modality Performed Procedure Step SOP Class.

DICOM [PS3.16 Section 7](#): DCMR Context Group Specifications

### 4.60.4 Messages



**Figure 4.60.4-1: Interaction Diagram**

Note: The diagram above shows the sequencing of messages for the Modality Performed Procedure Step SOP Class. Importers will also implement the Storage and Storage Commitment classes. The timing relationship between PPS messages and Storage and Storage Commitment messages is not specified. That is, PPS messages may occur before or after storage requests.

10950

10955

#### 4.60.4.1 Procedure Step Completed/Discontinued

##### 4.60.4.1.1 Trigger Event

User completes procedure step on the Importer.

##### 4.60.4.1.2 Message Semantics

10960 The Importer shall send Modality Performed Procedure Step SOP Class (N-SET service) to inform the Performed Procedure Step Manager that a specific Performed Procedure Step has been completed or discontinued.

10965 The final N-SET has either the MPPS status of “COMPLETED” or “DISCONTINUED”. The Performed Procedure Step Manager forwards N-SET messages to the Department System Scheduler/Order Filler, Image Manager and Report Manager.

When an N-SET is issued with a “DISCONTINUED” status, one or more Series of Instances may be referenced, if Evidence Objects were created and sent.

Note: DICOM specifies that when attributes are allowed to be set by an N-SET, the value provided by the last N-SET overrides any value set by an earlier N-CREATE or N-SET.

10970 **4.60.4.1.2.1 Retrieve AE Title**

According to the DICOM Standard, the Importer has the ability to include the Retrieve AE Title attribute (0008,0054) in the Performed Series Sequence (0040,0340). This is an AE Title where the referenced SOP instances for the series may be retrieved. This Retrieve AE Title will often be zero length or be of short-term validity, due to the following situations:

- 10975
- If an Importer supports a Retrieve SOP Class in an SCP Role, the Importer’s Retrieve AE Title may be included; however, the Importer does not guarantee long-term availability.
  - A Retrieve AE Title of the Image Manager can be configured on the Importer. Otherwise, this field shall be sent zero length. Importer implementers shall not assume that the destination AE Title used for the Storage SCP or Storage Commitment SCP is the same as that for Image Retrieval.
- 10980
- An Importer may receive the Retrieve AE Title in a Storage Commitment Message (N-EVENT REPORT). However, this information may be received well after the MPPS N-SET (Complete) was performed.

**4.60.4.1.2.2 Import PPS Exception Management**

10985 When the Modality Procedure Step is sent with the Status DISCONTINUED, the Procedure Step Discontinuation Reason Code Sequence (0040,0281) shall be sent with values defined in DICOM [PS3.16 Annex B CID 9302](#). The Reason Code when communicated to the DSS/Order Filler and Image Manager/Image Archive may imply canceling an order. It may also facilitate more accurate charge posting.

10990 The Reason Code: “Incorrect worklist entry selected” is used by the Importer to convey that the wrong Patient Demographics and/or Scheduled Procedure Step has been selected (incorrect patient or incorrect Requested procedure/order for the same patient). In this case some or all of the incorrectly imported Evidence Objects (for example the ones assigned to the wrong patient) may already have been stored to the Image Manager (see Section 4.60.4.1.3.1).

10995 Importer implementers are left free to decide how to correct the resultant evidence objects. The Importer shall include within the MPPS the list of imported objects that are or will be included in the Import Stored Transaction(s).

Note: When a PPS DISCONTINUED is sent with the reason code “Incorrect worklist entry selected”, evidence objects referenced in this PPS DISCONTINUED are Evidence Objects that may have been sent to the Image Manager/Archive. The IHE Radiology Technical Framework does not specify whether or not the Importer needs to perform a Storage Commitment for these instances.

11000

The Reason Codes “Equipment failure”, “Objects incorrectly formatted”, “Object Types not supported”, “Object Set incomplete” and “Media Failure” will be used to indicate that the expected Evidence Objects have been imported.

11005 **4.60.4.1.2.3 Billing and Material Management Option**

The message semantics are defined in the DICOM Service Class Section of the DICOM Modality Performed Procedure Step SOP Class. It is the responsibility of the Importer to ensure that the patient and procedure information is sent to the Department System Scheduler/Order Filler.

11010 The Attributes defined in Table 4.60-2 provide a means to transmit material management codes from the importer to the DSS/Order Filler that uses them for calculation of charges to be posted to the Charge Processor.

11015 An Importer that supports the Billing and Material Management Option shall be able to provide content within the Billing Procedure Step Sequence and the Billing Supplies and Devices Sequence. If the Billing Procedure Step is used, the Import Billing Code Table shall be configured on the Importer. This table shall be synchronized with the Department System Scheduler/Order Filler. The codes provided by the Importer might not be the same as the code the Department System Scheduler/Order Filler is required to use when posting Charges to the Charge Processor.

11020 The Billing Item Sequence provides the mechanism to track the number of media imported. See Table 4.60.3 for the list of Coded Values that may be specified in the Billing Item sequence when there are charges associated with importing items such as a CD or digitizing a Radiological Film. Multiple codes may be present.

**Table 4.60-2: Billing and Material Management Code Module Attributes Excerpt**

Attribute name	Tag	Attribute Description
Billing Procedure Step Sequence	(0040,0320)	Contains billing codes for the Procedure Type performed within the Procedure Step. The sequence may have zero or more Items. It may be zero-length if the Billing Supplies and Devices Sequence is populated.
> Code Value	(0008,0100)	
> Coding Scheme Designator	(0008,0102)	
> Code Meaning	(0008,0104)	
...		
Billing Supplies and Devices Sequence	(0040,0324)	Contains billing codes for chemicals, supplies and devices for billing used in the Performed Procedure Step. The sequence may have one or more Items.
>Billing Item Sequence	(0040,0296)	Codes values of chemicals, supplies or devices required for billing. The sequence may have zero or one Items.
>> Code Value	(0008,0100)	
>> Coding Scheme Designator	(0008,0102)	
>> Code Meaning	(0008,0104)	
>Quantity Sequence	(0040,0293)	Sequence containing the quantity of used chemicals or devices. The sequence may have zero or one Items.
>>Quantity	(0040,0294)	Numerical quantity value. Specifies the number of media imported or digitized.

Attribute name	Tag	Attribute Description
...		

11025

**Table 4.60-3: Context ID 7008 – Import Device Media**

Coding Scheme Designator (0008,0102)	Code Value (0008,0100)	Code Meaning (0008,0104)
DCM	110020	Sheet Film Scanned
DCM	110021	Cine Film Scanned
DCM	110022	Video Tape Scanned
DCM	110023	Page Digitized
DCM	110024	CD Imported
DCM	110025	DVD Imported
DCM	110026	MOD Imported
DCM	110027	Studies Imported
DCM	110028	Instances Imported

**4.60.4.1.3 Expected Actions**

11030

The Image Manager, Report Manager and Department System Scheduler/Order Filler receive information about the Performed Procedure Step being complete or discontinued. The Image Manager, Report Manager and Department System Scheduler are not required to act on intermediate N-SET messages with the MPPS Status “IN PROGRESS”.

In the case of the Scheduled Import, the Requested Procedure may be considered complete if all Performed Procedure Steps related to all Scheduled Procedure Steps have been completed or properly discontinued.

11035

**4.60.4.1.3.1 Import PPS Exception Management**

When an import exception occurs, the DSS/Order Filler or Image Manager/Archive shall use the reason codes in the final N-SET sent with the status of DISCONTINUED.

11040

When the Modality Procedure Step is received with the Status DISCONTINUED, the receiver shall interpret the Performed Procedure Step Discontinuation Reason Code Sequence (0040,0281) values as defined in DICOM (see Section 4.60.4.1.2.2). When received by the Department System Scheduler/Order Filler and the Image Manager/Archive, the Reason Code may indicate the necessity for modification or canceling of an order. With the Reason Code:

11045

“Incorrect Worklist Entry Selected”, the Importer conveys that the wrong SPS or Patient has been selected (e.g., incorrect patient or incorrect Requested procedure/order for the same patient). In this case, the Image Manager and Department System Scheduler shall take the appropriate action to ensure that already received incorrect instances (i.e., SOP Instances referenced by this Discontinued PPS) are not mistakenly used. If the images, presentation states, or key image notes are not actually deleted, the Image Manager shall:

- not return SOP Instance UIDs for the images in query responses,
- 11050
- not return such images in Patient, Study, Series, or Instance level retrievals,

On the DSS and Image Manager, the Order/Requested Procedure status shall be corrected to indicate that the discontinued PPS (with wrong worklist entry selected) is not valid. Therefore, the Order Filler/Department System Scheduler shall not query for those instances with an Image Availability Notification [RAD-49] transaction.

- 11055
- When the Modality Procedure Step is received with the Status DISCONTINUED, it shall include a Reason Code from the enumerated list (see Table 4.60-1). The Reason Code indicates that all of the Evidence Objects could not be imported. Typically, this will be because some of the DICOM Composite Objects are not supported by the local Enterprise. How the local Enterprise deals with this situation is up to local policies and is out of scope of the Technical Framework.

11060

#### **4.60.4.1.3.2 Billing and Material Management Information Option**

When Billing and Material Management information is provided in the MPPS N-SET, the DSS/Order Filler shall use the billing codes and/or material usage information provided in the final N-SET for calculation of charges that it will eventually post to the Charge Processor. It is recommended that DSS/Order Filler verifies the consistency of provided billing codes with Requested Procedure Code and Performed Procedure Step Protocol codes supplied in the same N-SET.

11065

### **4.61 Imported Objects Stored [RAD-61]**

#### **4.61.1 Scope**

- 11070
- In the Imported Objects Stored transaction, the Importer sends the Evidence Objects to the Image Archive. The reconciled information provided from the Modality Worklist [RAD-5] transaction or the Patient Demographics Query [ITI-21] transaction (see [ITI TF-2: 3.21](#)) shall be included in the headers of the generated images.

#### **4.61.2 Actor Roles**

**Actor:** Image Archive

- 11075
- Role:** Accept and store DICOM Composite Objects from the Portable Media Importer.

**Actor:** Importer

**Role:** Transmit imported DICOM object data to Image Archive

#### **4.61.3 Referenced Standards**

DICOM [PS3.4 Section B.4.1](#): Storage Service Class, Conformance as an SCP

- 11080
- DICOM [PS3.3 Section C.12.1](#): SOP Common Module

## 4.61.4 Messages

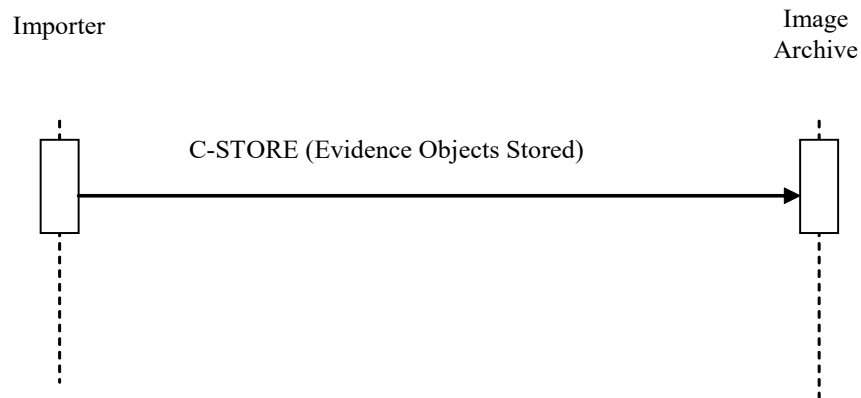


Figure 4.61.4-1: Interaction Diagram

### 4.61.4.1 Evidence Objects Stored

#### 11085 4.61.4.1.1 Trigger Events

The Importer can transfer Evidence objects to the Image Archive sequentially within one or more DICOM associations, as the Evidence objects become available or collectively.

##### 4.61.4.1.1.1 UIDs

11090 Valid DICOM UIDs are universally unique, so there should be no risk of collision with local UIDs. When a valid set of DICOM UIDs is present, the importer shall use this set and not change them. If the importer detects incorrect UIDs or an inconsistent set of UIDs, then it may correct or re-generate UIDs. The UIDs are used as references between objects, and if they are altered, the Importer shall maintain referential integrity. Additional details about when it is appropriate for an Importer to trigger the creation of a new Study/Series/Image Instance are described in Section 4.8.4.1.1.1 “Study UIDs and Series UIDs”.

11095

##### 4.61.4.1.2 Message Semantics

The Importer uses the DICOM C-STORE message to transfer the DICOM Composite Objects. The Importer is the DICOM Storage SCU and the Image Archive is the DICOM Storage SCP.

11100 If the import was scheduled, the User validates the available information for the patient and the Scheduled Procedure Step/Requested Procedure and coerces the Patient/Order Information as required (see Section RAD TF-2x: Appendix A.5).

If the import was not scheduled, the User validates the available information for the patient and coerces the Patient Information as required (see Section RAD TF-2x: Appendix A.5).

11105 It is a requirement that certain information be recorded in the image header. The details of the mapping to DICOM instances are specified in RAD TF-2x: Appendix A.5.

Per the DICOM Standard, the Importer shall create a new series for its created images (e.g., Digitization of Films) and not extend series containing source images.

**4.61.4.1.2.1 Original Attributes Sequence**

11110 When coercing (i.e., replacing or deleting attributes) from the original Evidence Objects, the Importer shall create or add to the “Original Attributes Sequence” (see Table 4.61.4.1.2-1) at the top level and store the original values of those altered DICOM elements underneath it as defined in RAD TF-2x: Appendix A.5.

11115 The Importer shall use the “Original Attribute Sequence” to preserve information about the original non-digitized data (e.g., Originating Institution, Time of the import, specific attributes from the originating Institution). The mechanism and values which are preserved is out of scope for the Technical Framework.

**Table 4.61.4.1.2-1: Original Attributes Sequence**

Attribute Name	Tag	Type	Attribute Description
...			
Original Attributes Sequence (Note 1,2)	(0400,0561)	R+	Sequence of Items containing all attributes that are specified by the User from the Original dataset. One or more Items may be permitted in this sequence.
>Source of Previous Values	(0400,0564)	R+	Identification of the Enterprise which originated the Films or Documents.
>Attribute Modification Datetime	(0400,0562)	R	Date and Time of the hardcopy scan
>Modifying System	(0400,0563)	R	Identification of the local Enterprise
>Reason for the Attribute Modification	(0400,0565)	R	Reason for the attribute modification. Defined terms are: COERCE = Replace values of attributes such as Patient Name, ID, Accession Number, for example, during import of media from an external institution, or reconciliation against a master patient index. CORRECT = Replace incorrect values, such as Patient Name or ID, for example, when incorrect worklist item was chosen or operator input error.
>Modified Attribute Sequence	(0400,0550)	R	Sequence containing a single item that contains all the Attributes that supplied by the User from the Original Films or Documents.
>>Any Attribute from the main data set that was modified			

Note 1: A new original attribute sequence is added every time the DICOM Objects are imported.



11120

Note 2: For digitized hardcopy the “old values” would be information the operator manually enters. It is expected that there would be only one sequence in this case.

**4.61.4.1.2.2 Contributing Equipment Sequence**

11125

In order to preserve the fact that these Evidence Objects have been imported into the Enterprise, the Contributing Equipment Sequence shall be used (see Table 4.61.4.1.2-2). This will allow the local Institution to make decisions based upon the fact that a set of Evidence Objects has been imported (e.g., Schedule an over-read based upon an import, delete the imported Evidence Objects after a prescribed amount of time). The behavior of how Imported Evidence Objects are used and maintained is out of scope of the IHE Technical Framework.

**Table 4.61.4.1.2-2: Contributing Equipment Sequence**

Attribute Name	Tag	Type	Attribute Description
Contributing Equipment Sequence	(0018,A001)	R+	See Notes 1 and 2
>Purpose of Reference Code Sequence	(0040,A170)	R	See Table 4.61.4.1.2-3
>>Include 'Code Sequence Macro' Table 8.8-1			Defined <a href="#">CID 7005</a>
>Manufacturer	(0008,0070)	R	
>Institution Name	(0008,0080)	R+	
>Station Name	(0008,1010)	R+	
>Contribution DateTime	(0018,A002)	R+	

11130

Note 1: For imported objects, a new item shall be added to the Contributing Equipment Sequence every time a DICOM Object is imported. Each item in the Contributing Equipment Sequence describes a particular piece of importing equipment. The Equipment Module attributes describe the original creator of the instances.

Note 2: For digitized hardcopy, the Contributing Equipment Sequence shall contain a single item describing the original acquisition equipment. Since the digitizer is the equipment creating the original DICOM instance, the Equipment Module attributes describe the hardcopy digitizer.

11135

The following table should be used to provide describe the equipment that has done the import. This information may be used by an Institution at a later time to take actions specific to data imported into the Enterprise.

**Table 4.61.4.1.2-3: Context ID 7005 – Contributing Equipment Most Restrictive Use: Defined**

11140

Coding Scheme Designator (0008,0102)	Code Value (0008,0100)	Code Meaning (0008,0104)
DCM	MEDIM	Portable Media Importer Equipment
DCM	FILMD	Film Digitizer Equipment
DCM	DOCD	Document Digitizer Equipment
DCM	VIDD	Video Tape Digitizer Equipment

#### 4.61.4.1.3 Expected Actions

The Image Archive will store the received DICOM objects.

11145 The DICOM Images, Evidence Documents and Diagnostic Reports shall be stored such that they can be later retrieved (see [RAD-16], [RAD-17], [RAD-27] and [RAD-43]) in a fashion meeting the requirements defined for a DICOM Level 2 Storage SCP (refer to DICOM [PS3.4 Section B.4.1](#)).

##### 4.61.4.1.3.1 DICOM Storage SOP Classes

11150 The DICOM Standard defines a number of image specific storage SOP classes, as well as other DICOM SOP Classes for DICOM SR, Encapsulated PDFs, etc. All standard attributes and private elements shall be stored.

11155 It is expected that the product's DICOM Conformance Statement will state which DICOM Storage SOP Classes it claims to support. Non-supported SOP Classes shall be rejected by the Image Manager/ Image Archive in the C-Store association. How the Institution deals with situations where DICOM Objects from the Importer cannot be stored is out of scope of the Technical Framework.

## 4.62 Store Dose Information [RAD-62]

### 4.62.1 Scope

11160 This section describes DICOM Storage requests of Structured Report objects containing Dose objects which detail irradiation events. An Acquisition Modality sends Dose objects to an Image Manager/Archive for storage so they can be later used for monitoring or analysis of patient radiation exposure.

### 4.62.2 Actor Roles

**Actor:** Acquisition Modality

11165 **Role:** Generate Dose objects describing irradiation events performed by the Acquisition Modality and store them to one or more receiving actors.

**Actor:** Image Manager/Archive

**Role:** Accept and Store Dose objects received from the Acquisition Modality.

**Actor:** Dose Information Consumer

11170 **Role:** Accept and process Dose objects received from the Acquisition Modality.

**Actor:** Dose Information Reporter

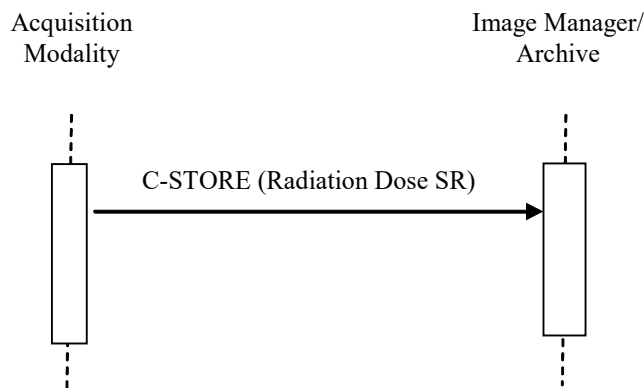
**Role:** Accept and process Dose objects received from the Acquisition Modality.

### 4.62.3 Referenced Standard

DICOM [PS3.3 Section A.35.8](#): X-Ray Radiation Dose SR IOD

- 11175 DICOM [PS3.4 Annex B](#): Storage Service Class
- DICOM [PS3.4 Section B.5.1.5](#): Structured Reporting Storage SOP Classes
- DICOM [PS3.16](#): X-Ray Radiation Dose SR IOD Templates
- DICOM [PS3.16](#): CT Radiation Dose SR IOD Templates
- DICOM [PS3.17 Annex AA](#): Radiation Dose Reporting Use Cases

11180 **4.62.4 Messages**



**Figure 4.62.4-1: Interaction Diagram**

Note: In the above diagram, the Dose Information Consumer and the Dose Information Reporter may also receive the C-STORE message.

11185 **4.62.4.1 Store Dose Information**

The Acquisition Modality shall implement the X-ray Radiation Dose SR Storage SOP Class in the role of SCU. The Image Manager/Archive, Dose Information Reporter and Dose Information Consumer shall implement the Dose Storage SOP Class in the role of SCP.

**Table 4.62-1: Dose Storage SOP Classes**

SOP Class UID	SOP Class Name
1.2.840.10008.5.1.4.1.1.88.67	X-Ray Radiation Dose SR

11190

**4.62.4.1.1 Trigger Events**

An irradiation event is a single continuous exposure of radiation. For a more precise definition including details relating to pulsed acquisition, dose modulation, dual source systems, etc. refer to DICOM PS3.16.

11195 An Acquisition Modality shall record the relevant details for each irradiation event. These details will be included in Dose objects as described below.

Upon completion or discontinuation of a procedure step where irradiation events occurred, the Acquisition Modality shall compose an appropriate Dose Object containing all the irradiation events for the procedure step and send the Dose object to the configured destinations.

11200 Note: The Dose Object is a DICOM Instance created in the context of the procedure step, and thus is expected to appear in the list of instances in the corresponding MPPS.

11205 In addition to composing Dose objects upon completion or discontinuation of a procedure step, the Acquisition Modality may also compose and send a Dose object upon completion of an irradiation event. If such behavior is supported, the actor shall provide a configuration method to disable it. Such objects could enable applications like dose mapping by a workstation during a procedure. The irradiation events will duplicate events reported in the Dose object for the procedure step, but this can be detected by receiving systems since the same irradiation event UID will appear in both Dose objects.

11210 In addition to composing Dose objects upon completion or discontinuation of a procedure step, the Acquisition Modality may also compose and send a Dose Object summarizing an entire study or series. Such objects might be preferred by systems wanting a summary of several procedure steps. If such behavior is supported, the actor shall provide a configuration method to disable it. The irradiation events will duplicate events reported in the Dose object for the procedure step, but this can be detected by receiving systems since the same irradiation event UID will appear in

11215 both Dose objects. If the Acquisition Modality does compose such additional Dose objects, it is appropriate to record the prior reports in the Predecessor Documents Sequence (0040,A360).

The Acquisition Modality shall clearly document in its DICOM Conformance Statement its capabilities for grouping irradiation events into Dose objects.

#### **4.62.4.1.1.1 Digitization**

11220 In the case of a system digitizing a film produced locally for which a Dose object has not been generated, it would be appropriate to create and store a Dose object along with the digital images. The digitizing system might create the report based on manual entry. An adjacent system might create the report based on information in the generated images and/or the MPPS from the film-based modality.

11225 Digitizing films for external priors shall be handled differently. The location where the prior was originally created is responsible for recording the original dose. The digitizing system shall be configurable/controllable to digitize external films and not produce a Dose object.

#### **4.62.4.1.2 Message Semantics**

11230 The Acquisition Modality shall use the DICOM C-STORE message to send Dose objects encoded as DICOM SR objects. These objects serve as a record of irradiation performed by the device.

The Acquisition Modality shall be capable of sending the Dose object to multiple destinations. The primary storage destination is generally an Image Manager/Archive; however, Dose

- 11235 Information Reporters or Dose Information Consumers may also appear as configured destinations when they need to receive timely Dose objects without having to repeatedly poll the Image Manager/Archive.
- The Acquisition Modality is responsible for delivery of Dose objects to the destination in spite of intermittent connections (e.g., due to mobile modalities, network trouble, or the destination being down).
- 11240 The contents of the X-Ray Radiation Dose SR objects are generally based on Baseline Template [TID 10001](#) “Projection X-ray Radiation Dose” or Baseline Template [TID 10011](#) “CT Radiation Dose”, but it should be noted that those templates are extensible, and the use of additional templates is not prohibited.
- 11245 **Note:** DICOM has extended these templates (and the templates they contain) several times since they were originally introduced and further enhancements are possible. Implementers are reminded that they are responsible for monitoring such changes and keeping their implementations current.
- Acquisition Modality Actors which report on irradiation events for Modalities of type CT shall be capable of producing an SR compliant with TID 10011.
- 11250 Acquisition Modality Actors which report on irradiation events for Modalities of type XR, XA, RF, MG, CR, or DX shall be capable of producing an SR compliant with TID 10001.
- The Irradiation Event UID in the template allows receiving systems to recognize duplicate events. For example, the same dose event might appear in both an SR summarizing a procedure and an SR summarizing the whole study.
- 11255 The following attributes are Type 2 and Type 3. Although not required, Acquisition Modalities which do not fill them in will make their Dose objects more difficult to process and analyze. If present with a value in the Dose object, these attributes shall be populated as described in Table 4.62-2.

**Table 4.62-2: Dose Context Attributes**

Attribute Name	Tag	Requirement
Series Description	(0008,103E)	Shall have a value in the appropriate language for local use that means the equivalent of “Radiation Dose Information”, or similar.
Referenced Performed Procedure Step Sequence	(0008,1111)	Shall list the SOP Class UID and Instance UID of the image acquisition PPS. Typically, only a single PPS is associated with a Dose object. Since DICOM only permits a single value in this sequence, in the case where a Dose object summarizes several PPS (e.g., of a whole multi-step study), this attribute shall be left empty.
Performed Procedure Code Sequence	(0040,A372)	Shall contain the codes for the acquisition procedures performed by the modality (i.e., not a code for “Create Dose Report”). Creation of the Dose object is to be considered part of the imaging procedure, not a separate procedure in itself.
Requested Procedure Description	(0032,1060)	Shall be copied from the relevant acquisition SPS (Modality Worklist entry)
Admitting Diagnoses Description	(0008,1080)	

Attribute Name	Tag	Requirement
Admitting Diagnoses Code Sequence	(0008,1084)	Shall be copied from the relevant acquisition SPS (Modality Worklist entry). This can facilitate checking compliance to indication-based dose policies.
Reason for the Requested Procedure	(0040,1002)	
Reason for Requested Procedure Code Sequence	(0040,100A)	
Patient's Weight	(0010,1030)	Shall be copied from the relevant acquisition SPS (Modality Worklist entry), if present, else obtained by operator entry and may be approximate. This may facilitate future dose estimation and analysis.
Patient's Size	(0010,1020)	I.e., height. Shall be copied from the relevant acquisition SPS (Modality Worklist entry), if present, else obtained by operator entry, and may be approximate. This may facilitate future dose estimation and analysis.
Patient's Age	(0010,1010)	Shall be filled from any valid source (e.g., computed from Patient's Birthdate and Study Date, copied from the relevant acquisition SPS (Modality Worklist entry), if present, else obtained by operator entry) and may be approximate. This may facilitate future dose estimation and analysis.
Patient's Sex	(0010,0040)	Shall be copied from the relevant acquisition SPS (Modality Worklist entry), if present, else obtained by operator entry.

- 11260 In the event of a Group Case acquisition (see Section 4.6.4.1.2.3) a Dose object shall be generated, reflecting the single acquisition procedure step performed, and should take its attribute values from that image set. The procedure type would reflect the combined acquisition. Allocating subsets of the dose to the pseudo-sub-procedures of the group is not required. If the modality chooses to replicate the dose object under each component accession of the group case it shall set the Identical Documents Sequence appropriately. In either case the DIR can recognize the duplication based on the Irradiation Event UIDs.
- 11265

If the Dose object is not being created by the equipment which actually administered the radiation, the equipment creating the report shall reference itself in the Contributing Equipment Sequence (0018,A001) and reference the irradiating equipment in the four Type 1 attributes in the Enhanced General Equipment Module (DICOM [PS3.3 Section C.7.5.2](#)).

11270

The Acquisition Modality shall be capable of creating Dose objects for patient scans and for phantom/calibration scans.

#### 4.62.4.1.2.1 Cross-referencing Dose Objects and Image Objects

- 11275 See Section 4.8.4.1.2.4, which requires Acquisition Modalities to record the Irradiation Event UID (0008,3010) in related image instances.

The Projection X-Ray Dose Template ([TID 10003](#)) mandates that UID references be recorded in the Acquired Image element for image instances created from the irradiation event. The CT Dose Template does not include references to images since the instances sent to the Image Manager/Archive are typically generated some time after the irradiation is complete.

11280 Note that it is possible for a study to have dose objects but no image objects. For example, due to poor quality images not being stored, or fluoroscopy images not being captured.

#### **4.62.4.1.3 Expected Actions**

11285 The Image Manager/Archive shall support Level 2 (Full) storage, which means all DICOM Type 1, 2 and 3 attributes (public and private) are stored. It shall accept the Dose objects, store them, and make them available for query/retrieval.

11290 The Dose Information Reporter and Dose Information Consumer shall accept the Dose objects. The Dose objects shall be processed according to the features, configuration, and business logic of the Dose Information Reporter or Dose Information Consumer product. Possibilities include display, processing, analysis, printing, export, etc. At a minimum, the Dose Information Reporter shall provide the capability to the review and do summary analysis of the dose data.

Dose Information Reporter Actors shall be capable of processing both [TID 10001](#) and [TID 10011](#).

11295 When multiple Dose objects are received, the same Irradiation Event (as identified by its Irradiation Event UID) may be referenced in multiple Dose objects. It is the responsibility of the recipient to recognize such duplicate Irradiation Events when processing or generating reports based on the retrieved data.

### **4.63 Submit Dose Information [RAD-63]**

#### **4.63.1 Scope**

11300 This section describes DICOM Structured Report objects that detail irradiation events that are stored via DICOM Web Services. A Dose Information Reporter sends Dose objects to a Dose Registry for subsequent compilation, monitoring and analysis of population and individual radiation exposure and current practices. Dose objects will often be de-identified prior to submission for the population use case.

#### **4.63.2 Actor Roles**

11305 **Actor:** Dose Information Reporter

**Role:** Submit (de-identified) Dose objects describing irradiation events performed by Acquisition Modalities or Radiopharmaceutical Activity Suppliers in its facility.

**Actor:** Dose Registry

**Role:** Accept and store Dose objects received from Dose Information Reporters.

#### **4.63.3 Referenced Standard**

DICOM [PS3.3 Section A.35.8](#): X-Ray Radiation Dose SR IOD

DICOM [PS3.3: Section A.35.14](#) Radiopharmaceutical Dose SR IOD

DICOM [PS3.10](#): Media Storage and File Format

- DICOM [PS3.16](#): X-Ray Radiation Dose SR IOD Templates
- 11315 DICOM [PS3.16](#): CT Radiation Dose SR IOD Templates
- DICOM [PS3.16](#): Radiopharmaceutical Dose SR IOD Templates
- DICOM [PS3.17: Annex OOO](#): Radiopharmaceutical Radiation Dose Structured Report (Informative)
- DICOM [PS3.18 Section 10.5](#): Web Services - Store Transaction of the DICOM Studies Service
- 11320 (also known as STOW-RS Request/Response)

#### 4.63.4 Messages

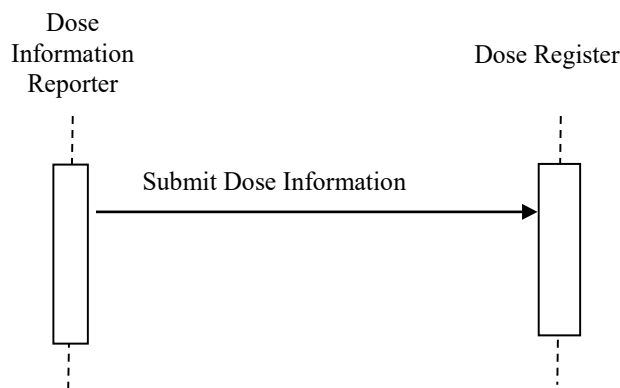


Figure 4.63.4-1: Interaction Diagram

#### 4.63.4.1 Submit Dose Information Message

##### 11325 4.63.4.1.1 Trigger Events

A Dose Information Reporter shall be capable of periodically submitting Dose objects accumulated since the last submission.

The Dose Information Reporter shall support submitting at a configurable interval, or upon a manual trigger, or both.

- 11330 Local site policy and preferences will dictate whether periodic submissions take place, at what frequency, whether the Dose objects are first de-identified, and which Dose objects are submitted (e.g., the site might submit a random sample, or just reports for certain types of procedures, etc.)

##### 4.63.4.1.2 Message Semantics

- 11335 The Submit Dose Information message is a Store transaction of the DICOM Studies Service. See DICOM [PS3.18 Section 10.5](#).

The Dose Information Reporter is the User Agent. The Dose Registry is the Origin Server.



The message shall correspond to the DICOM Study Resource. See DICOM [PS3.18 Section 10.5.1.1.1](#).

- 11340 The Dose Information Reporter shall format the message per DICOM [PS3.18 Section 10.5.1.4](#). The request payload shall contain DICOM PS3.10 representations of DICOM Dose SR(s) with a Transfer Syntax of Explicit VR Little Endian.

Except for de-identification, the Dose objects submitted by the Dose Information Reporter will generally be copies of reports received via the Store Dose Information [RAD-62] or Retrieve Dose Information [RAD-65] transactions.

- 11345 The Dose Information Reporter shall ensure that the attributes described either in [RAD-62] in Table 4.62-2 Dose Context Attributes, or in [RAD-110] in Table 4.110.4.1.2-1 Radiopharmaceutical Administration Dose Context Attributes, are populated (i.e., not empty and not zero or some other dummy value), even if this requires a quality control step with additional manual data entry by an operator.

- 11350 It may also be desirable to send the localizer images to the Dose Registry, since size estimates can be produced from these by image processing or manual measurement. An individual registry might require this, so a Dose Information Reporter may have the capability to obtain and include images with a Modality of CT and an Image Type (0008,0008) value 3 of LOCALIZER (for either non-enhanced and enhanced SOP classes).

- 11355 The Dose Information Reporter shall be capable of sending the Dose objects to multiple configured destinations.

The Dose Information Reporter is responsible for delivery of Dose objects in spite of intermittent connections (network trouble, or the destination system being down).

#### **4.63.4.1.2.1 De-identification**

- 11360 The Dose Information Reporter shall be capable of de-identifying Dose objects before submitting them.

There is considerable variation in what attributes need to be removed to achieve sufficient de-identification for any particular purpose. See the discussion in RAD TF-2x: Appendix I and DICOM [PS3.15 Annex E](#).

- 11365 Accordingly, this transaction does not require the removal of all text attribute values, nor the removal of all private attribute values.

- 11370 The Dose Information Reporter may provide a mechanism to allow the user to configure those attributes that will be removed or replaced. At minimum the Dose Information Reporter shall support the ability to configure removal and replacement of all those attributes listed in the Basic Application Level Confidentiality Profile in DICOM [PS3.15 Section E.1.1](#). It shall be configurable to use:

- the Retain Longitudinal Option
- Retain Patient Characteristics Option

- Retain Device Information Option
- 11375      • Retain UIDs Option
- This configurability is particularly important since details such as patient sex, approximate age and weight, anatomy imaged and type of procedure are typically part of population dose analysis and such analysis would be severely limited without the ability to leave such information in submitted data. If the value in the Patient Birth Date (0010,0030) is removed from a Dose object during de-identification, then the Patient Age (0010,1010) attribute shall be included with an appropriate value.
- 11380      When de-identification has been performed, the Dose Information Reporter shall add to the DICOM dataset of each instance the Patient Identity Removed (0012,0062) attribute with a value of YES, and add a value for De-identification Method Code Sequence (0012,0064).
- 11385      The Dose Information Reporter shall be configurable to perform no de-identification at all.
- In some scenarios, it may be appropriate to perform no de-identification, such as when the Dose Registry is doing a longitudinal study for specific patients (and necessary consents and/or privacy agreements have been taken care of). In such cases, if the Patient Identity Removed (0012,0062) attribute is present in the dataset it shall not be changed before submitting the dataset; if the attribute is absent it shall be added with a value of NO.
- 11390      The Dose Information Reporter shall be capable of different de-identification configuration settings for each submission destination.
- In some de-identification scenarios, the UIDs might need to be replaced. This transaction does not require that the Dose Information Reporter have the ability to replace UIDs, but if UIDs are replaced, internal consistency within the exported set of instances and across multiple exports over time shall be maintained. This entails adherence to the following rules:
- 11395
  - The same replacement UID is used for all composite instances of the same entity within the set, e.g., if the Study Instance UID is replaced, it is replaced with the same value in all dose objects within the same original study.
- 11400
  - References by UID to other instances or entities within the set are updated, e.g., references to the SOP Instance UIDs of predecessor documents, reference images and source images.
  - References by UID to other instances or entities not included within the set are removed or replaced with consistent, well-formed, dummy references.
- 11405      If the same instances are exported multiple times on different occasions, the identifying attributes and UIDs therein shall be replaced with the same values on each occasion. That is, this transaction requires deterministic behavior for replacement of identifying attributes and UIDs. This assures that the receiving Dose Registry can detect duplicate submissions and not accumulate the same dose multiple times. The safest way to assure detection of duplicate submissions from a single site or multiple sites is not to replace the UIDs in the first place, but
- 11410      local regulations or policy may not permit this.

The Dose Information Reporter performing de-identification shall not create invalid IODs. Specifically:

- Mandatory and conditional attributes may not be removed, but rather must be replaced.
- 11415
- Type 1 attributes must be given a value.
  - Type 2 attributes may be encoded zero length, but it is often advisable to encode a value, especially for attributes likely to be used in browsers such as Patient Name, Patient ID, Study ID and Accession Number.
  - UIDs shall have valid roots and be genuinely globally unique.
- 11420
- The Dose Information Reporter is not required to be able to pseudonymize Dose objects. For a description of pseudonymization, see Section 4.51.4.1.4.

#### **4.63.4.1.3 Expected Actions**

The Dose Registry shall accept and process the message payload. What it does with the Dose objects will depend on the features, configuration, and business logic of the product. Some details of several Dose Registry projects are discussed in RAD TF-1x: Appendix I – Deployment of Dose Registries.

11425

Although the Dose Information Reporter may keep track of which Dose objects have been previously submitted to avoid duplicates or missing objects, the Dose Registry cannot depend on every object being sent, and should also be prepared to check for duplicates (by checking the Irradiation Event UIDs, though these may have been affected by de-identification during the current and previous submission, particularly if the same information is received multiple times from different Dose Information Reporters).

11430

#### **4.63.4.2 Return Message Status**

The Dose Registry reports the outcome of the Submit Dose Information Message.

##### **4.63.4.2.1 Trigger Events**

The Dose Registry receives a Submit Dose Information message.

11435

##### **4.63.4.2.2 Message Semantics**

The Dose Registry shall return a response to the Sender according to DICOM [PS3.18 Section 10.5.3](#).

11440

The Dose Information Reporter is the User Agent. The Dose Registry is the Origin Server.

##### **4.63.4.2.3 Expected Actions**

The Dose Information Reporter has no expected actions.

## 4.63.5 Security Considerations

### 4.63.5.1 Security Audit Considerations

11445 The [Radiology Audit Trail Option](#) in the IHE ITI [Audit Trail and Node Authentication](#) (ATNA) Profile ([ITI TF-1:9](#)) defines audit requirements for IHE Radiology transactions. See RAD TF-3: 5.1.1.1.

The Dose Registry can identify the Dose Information Reporter (for audit purposes) using the IP address of the User-Agent, or use different URL end points for each Dose Information Reporter.

### 11450 4.63.5.2 Transport Security

In order to avoid unauthorized interception of private health information, the communication over HTTP may be secured by using HTTPS.

## 4.64 Query Dose Information [RAD-64]

### 4.64.1 Scope

11455 A Dose Information Reporter, Dose Information Consumer, or Acquisition Modality requests and receives from the Image Manager/Archive a list of instance metadata describing Dose objects matching a specified filter.

### 4.64.2 Actor Roles

<b>Role:</b>	<b>Requester:</b> Query for a list of Dose objects.
<b>Actor(s):</b>	The following actors may play the role of Requester: Dose Information Reporter Dose Information Consumer Acquisition Modality
<b>Role:</b>	<b>Manager:</b> Respond to queries for Dose objects matching the specified filter.
<b>Actor(s):</b>	The following actors may play the role of Manager: Image Manager/Archive

### 4.64.3 Referenced Standard

11460 DICOM [PS3.4 Annex C](#): Query/Retrieve Service Class  
 DICOM [PS3.4 Section B.5.1.5](#): Structured Reporting Storage SOP Classes  
 DICOM [PS3.3 Section A.35.8](#): X-Ray Radiation Dose SR IOD

DICOM [PS3.3: Section A.35.14](#): Radiopharmaceutical Dose SR IOD

#### 4.64.4 Messages

Requester

Manager

Query Dose Reports (C-FIND)

Query Responses (C-FIND)

11465

**Figure 4.64.4-1: Interaction Diagram**

##### 4.64.4.1 Query Dose Information

11470 The Query (Study Root – FIND and optionally Patient Root – FIND) SOP Classes shall be supported. Refer to DICOM PS3.4: Query/Retrieve Service Class for detailed descriptive semantics.

##### 4.64.4.1.1 Trigger Events

The Dose Information Reporter needs to obtain information about Dose objects.

11475 Often this will be triggered by the Dose Information Reporter preparing to produce reports, preparing to perform analyses or preparing to submit data to a dose registry based on local policies. Examples of such triggers might include generating a daily report of procedures exceeding Diagnostic Reference Levels for certain procedure types, producing a summary of dose to a particular patient over the past year, or submitting reports for all procedures performed in the past week to a national dose registry.

The Dose Information Consumer needs to obtain information about Dose objects.

11480 Often this will be triggered by the Dose Information Consumer preparing to display or further process the contents of one or more Dose objects. Examples of such triggers might include processing the contents of a dose object together with the generated images in order to produce a dose map. Refer to the Use Cases in RAD TF-1: 22.3 “Radiation Exposure Monitoring Process Flow” for more details.

11485 The Acquisition Modality needs to obtain administered dose information from a Dose object.

This will be triggered by the modality that will perform the imaging procedure. It will read the Dose object to determine information about the radiopharmaceutical that was administered to the patient for an imaging procedure, including the actual administered dose, and the date and times it was assayed and administered.

11490 **4.64.4.1.2 Message Semantics**

The message semantics are defined by the DICOM Query/Retrieve SOP Classes.

The Requester shall implement the Query/Retrieve SOP Classes in the role of SCU. The Manager shall implement the Query/Retrieve SOP Classes in the role of SCP.

11495 A C-FIND Request from the DICOM Study Root Query/Retrieve Information Model – FIND SOP Class or the DICOM Patient Root Query/Retrieve Information Model – FIND SOP Class shall be sent from the Requester to the Manager.

The Requester uses one or more matching keys as filter criteria to obtain the list of matching entries in the Image Manager/Archive at the selected level (Patient & Study/Series/Instance).

11500 In addition to the required and unique keys defined by the DICOM Standard, the Dose Report Query SCU and SCP shall support the matching and return keys defined for Study, and Series level queries as defined in Section 4.14.4.1.2 and Table 4.14-1.

The Requester (SCU) and the Manager (SCP) shall also support the Dose Report Instance-specific keys defined in Table 4.64-1.

**Table 4.64-1: Dose Report Instance Specific Query Matching and Return Keys**

Attribute Name	Tag	Query Keys Matching		Query Keys Return	
		SCU	SCP	SCU	SCP
<b>Dose Report Instance Specific Level</b>					
SOP Class UID	(0008,0016)	O	R+	O	R+
SOP Instance UID	(0008,0018)	O	R	O	R
Content Date	(0008,0023)	O	O	O	R+
Content Time	(0008,0033)	O	O	O	R+
Referenced Request Sequence	(0040,A370)				
>Study Instance UID	(0020,000D)	O	O	R+*	R+
>Accession Number	(0008,0050)	O	O	R+	R+
>Requested Procedure ID	(0040,1001)	O	O	R+	R+
>Requested Procedure Code Sequence	(0032,1064)				
>>Code Value	(0008,0100)	O	O	O	R+
>>Coding Scheme Designator	(0008,0102)	O	O	O	R+
>>Coding Scheme Version	(0008,0103)	O	O	O	R+
>>Code Meaning	(0008,0104)	O	O	O	R+
Content Template Sequence	(0040,A504)				
>Template Identifier	(0040,DB00)	O	O	R+	R+
Concept Name Code Sequence	(0040,A043)				
>Code Value	(0008,0100)	O	O	R+*	R+
>Coding Scheme Designator	(0008,0102)	O	O	R+*	R+
>Coding Scheme Version	(0008,0103)	O	O	O	R+

Attribute Name	Tag	Query Keys Matching		Query Keys Return	
		SCU	SCP	SCU	SCP
>Code Meaning	(0008,0104)	O	O	R+	R+

11505 The requirement conventions for key usage in the above table are defined in Section 2.2.

#### 4.64.4.1.2.1 Filtering Strategies

Since it may not be immediately obvious how to perform certain dose object filtering based on the available matching keys, return keys and object content, some suggestions are provided here.

11510 Filtering can occur at three points. Matching keys allow filtering on the server side; only instances that pass the filter have metadata returned. Return keys allow filtering on the client side; only instances whose metadata passes the filter are subsequently retrieved. Finally, object attributes or content tree elements allow further client-side filtering; only retrieved instances that pass the filter are processed further.

11515 Client-side filtering of the object attributes and content is the most flexible, but to avoid retrieving an unnecessarily large number of objects, the use of matching and return keys is very helpful.

To filter for Dose objects:

- Matching key – SOP Class UID (0008,0016) allows selection of the X-ray Radiation Dose SR Storage SOP Class or the Radiopharmaceutical Administration Radiation Dose SR Storage SOP Class.

To filter for a specific date range:

- Matching key – Study Date (0008,0020) and/or Performed Procedure Step Start Date (0040,0244) allows selection of a particular date or range.

To filter for specific modalities:

- Matching key – Modalities in Study (0008,0061) allows selection of a desired modality (e.g., CT, XA, DR, DX, CR, MX, NM, PT, SR)

Note: Some studies might have multiple irradiating modalities so it will still be necessary to confirm the modality in the dose report. Note also that the series level Modality attribute will always be SR for dose reports.

- Return key – Template ID (0040,DB00) allows identification of either CT, Projection X-Ray, or Radiopharmaceutical Administration dose reports. Future dose reports will also be identifiable by new Template ID values, making this a potentially valuable attribute for the Archive to support as a matching key.
- Object Content Tree – Procedure Reported allows differentiation of Mammography from other types of projection x-ray

11535 To filter for specific procedure types:

- Object Attribute – Performed Procedure Code Sequence (0040,A372) is Type 2, but if filled in the Dose object, will contain the acquisition procedures performed, allowing

11540 identification of the procedure. Since these are local codes and tend to change, systems will likely need to use a lookup table to map the variety of procedure/anatomy codes to a smaller set for performing analysis and reporting.

- Object Content Tree – Acquisition Protocol, if present, may also help identify the procedure type.

Note: Series Description (0008,103E) is a Type 3 attribute which, if present, in a Dose object will have a value of “Radiation Dose Information”.

11545 To filter for specific body regions:

- Object Content Tree – Target Region allows identification of body regions.

Note: Some implementations may provide a very specific region and the filter will want to generalize; other implementations may be unable to identify the exact region and will provide an overly generalized region instead.

11550 • Object Content Tree – Anatomical Structure, if present, may also identify body regions in projection x-ray dose reports.

To filter for patient age category:

- Return key – Patient’s Birth Date (0010,0030) allows identification of patients in an age range.

11555 • Return key – Patient’s Age (0010,1010) is a Type 3 attribute and an optional return key but may allow identification of some patients in an age range.

To filter for patient weight category:

- Return key – Patient’s Weight (0010,1030) is a Type 3 attribute and an optional return key but may allow identification of some patients in a weight range.

To filter for patient sex:

11560 • Return key – Patient’s Sex (0010,1040) allows identification of patient’s sex (e.g., for monitoring policies relating to women of childbearing age).

#### **4.64.4.1.3 Expected Actions**

The Manager receives the C-FIND request, performs the matching on the provided keys and sends the list of matching records back to the Requester via C-FIND responses.

11565 The Requester may use the value of certain return keys to identify specific Dose objects for subsequent retrieval. See Section 4.64.4.1.2.1 or 4.110.4.1.2.1 for details. Some details are only available by first retrieving and then parsing the dose objects.

### **4.65 Retrieve Dose Information [RAD-65]**

#### **4.65.1 Scope**

11570 A Dose Information Reporter, Dose Information Consumer, or Acquisition Modality requests and receives from the Image Manager/Archive specified instances of Dose objects.



#### 4.65.2 Actor Roles

**Actor:** Dose Information Reporter

**Role:** Request and receive specific Dose objects from the Image Manager/Archive.

11575 **Actor:** Dose Information Consumer

**Role:** Request and receive specific Dose objects from the Image Manager/Archive.

**Actor:** Acquisition Modality

**Role:** Request and receive specific Dose objects from the Image Manager/Archive.

**Actor:** Image Manager/Archive

11580 **Role:** Provide specified Dose objects requested by Dose Information Reporters and Dose Information Consumers.

#### 4.65.3 Referenced Standard

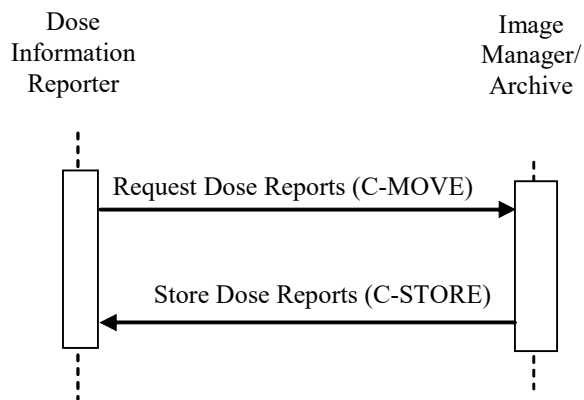
DICOM [PS3.4 Annex C](#): Query/Retrieve Service Class

DICOM [PS3.4 Section B.5.1.5](#): Structured Reporting Storage SOP Classes

11585 DICOM [PS3.3 Section A.35.8](#): X-Ray Radiation Dose SR IOD

DICOM [PS3.3: Section A.35.14](#) Radiopharmaceutical Dose SR IOD

#### 4.65.4 Messages



**Figure 4.65.4-1: Interaction Diagram**

11590 Note: In the above diagram, the Dose Information Consumer or Acquisition Modality may also submit a C-MOVE request and receive a C-STORE message.

#### 4.65.4.1 Retrieve Dose Information

The Retrieve (Study Root – MOVE and optionally Patient Root – MOVE) SOP Classes shall be supported. This requires that C-MOVE also be supported at the Series Level. Refer to the DICOM PS3.4 Annex C for detailed descriptive semantics.

11595

Actors that claim support of the Radiation Exposure Monitoring (REM) Profile or the Radiation Exposure Monitoring for Nuclear Medicine (REM-NM) Profile shall support the SOP Classes shown in Table 4.65-1 as indicated by the Profile Supported column.

**Table 4.65-1: Dose Storage SOP Classes**

SOP Class UID	SOP Class Name	Profile Supported
1.2.840.10008.5.1.4.1.1.88.67	X-Ray Radiation Dose SR	REM
1.2.840.10008.5.1.4.1.1.88.68	Radiopharmaceutical Administration Radiation Dose SR	REM-NM

11600

**4.65.4.1.1 Trigger Events**

The Dose Information Reporter, Dose Information Consumer, or Acquisition Modality decides it needs a specific Dose object.

**4.65.4.1.2 Message Semantics**

11605 The message semantics are defined in the DICOM Query/Retrieve Service Class Section of the DICOM PS3.4: Query/Retrieve Service Class. The Dose Information Reporter, Dose Information Consumer, or Acquisition Modality is the DICOM C-Move SCU and DICOM Storage SCP and the Image Manager/Archive is the DICOM C-Move SCP and DICOM Storage SCU.

11610 The contents of the X-Ray Radiation Dose SR objects are based on Baseline Template [TID 10001](#) “Projection X-ray Radiation Dose” or Baseline Template [TID 10011](#) “CT Radiation Dose”. The contents of the Radiopharmaceutical Administration Radiation Dose SR objects are based on Baseline Template [TID 10021](#) “Radiopharmaceutical Radiation Dose”. However, it should be noted that those templates are extensible, and the use of additional templates is not prohibited.

11615

It is the responsibility of the Image Manager/Archive to assure that the patient and procedure information is current in the Dose objects when they are retrieved from the Image Manager/Archive.

11620 The Image Manager/Archive receives the C-MOVE request, establishes a DICOM association with the Dose Information Reporter, Dose Information Consumer or Acquisition Modality, and uses the DICOM C-STORE command to transfer the requested Dose objects.

**4.65.4.1.3 Expected Actions**

11625 The Dose Information Reporter, Dose Information Consumer, or Acquisition Modality shall accept the Dose objects. The Dose objects shall be processed according to the features, configuration, and business logic of the Dose Information Reporter or Dose Information Consumer product. Possibilities include display, processing, analysis, printing, export, etc.

Dose Information Reporters that claim support of the REM Profile shall be capable of processing both [TID 10001](#) and [TID 10011](#). Dose Information Reporters that claim support of the REM-NM Profile shall be capable of processing TID [10021](#).

11630 The Dose Information Reporter or Dose Information Consumer shall not return an error to the Archive due to not recognizing the template used or the retrieved document content. The retrieved results may simply be discarded instead.

X-Ray Irradiation Events are identified by an Irradiation Event UID (0008,3010).

11635 Radiopharmaceutical Administration Events are identified by a Radiopharmaceutical Administration Event UID (0008,3012). The same Event may be referenced in multiple Dose objects. For example, the same dose event might appear in both an SR summarizing a procedure and an SR summarizing the whole study.

The Dose Information Reporter and Dose Information Consumer shall recognize duplicate Events based on the Event UIDs in the Dose object.

11640 The Dose Information Reporter shall be capable of presenting some form of report to the user based on the retrieved dose information. The format, contents and analysis of such reports are not defined by the IHE. Such details should be worked out as part of the product design.

## 4.66 Rejection Note Stored [RAD-66]

### 4.66.1 Scope

11645 This transaction permits a Sender to mark referenced instances as “rejected” including:

- images rejected for quality reasons (with a reason for rejection)
- incorrect images rejected for patient safety reasons
- images rejected for incorrect modality worklist selection reason
- instances to be deleted due to data retention policy expiration (with a reason for deletion).

### 11650 4.66.2 Actor Roles

The roles in this transaction are defined in the following table and may be played by the actors shown here:

**Table 4.29.2-1: Actor Roles**

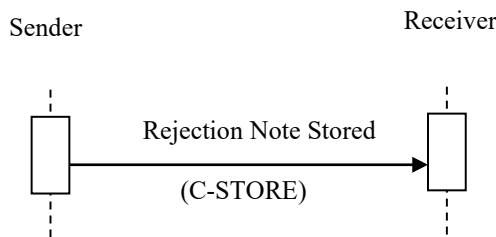
<b>Role:</b>	<b>Sender:</b> Flags significant images by creating a Key Object Selection instance and sending it to the Receiver.
<b>Actor(s):</b>	The following actors may play the role of Sender: Acquisition Modality Evidence Creator
<b>Role:</b>	<b>Receiver:</b> Receives and stores Key Object Selection instances.

<b>Actor(s):</b>	The following actors may play the role of Receiver: Imager Manager / Image Archive
------------------	---------------------------------------------------------------------------------------

**4.66.3 Referenced Standards**

- 11655 DICOM [PS3.3 Section A.35.4](#): Key Object Selection Document IOD
- DICOM [PS3.4 Annex B](#): Storage SOP Class
- DICOM [PS3.4 Annex C](#): Query/Retrieve SOP Class
- DICOM [PS3.16 TID 2010](#): Key Object Selection
- DICOM [PS3.16 CID 7011](#): Rejected for Quality Reasons

11660 **4.66.4 Messages**



**Figure 4.66.4-1: Interaction Diagram: Rejection Note Stored**

The following table summarizes Key Object Selection Document Titles usage in different profiles:

11665 **Table 4.66.4-1: Key Object Selection Document Title Usage by Profile**

KOS Document Title	IOCM	Section
(113001, DCM, “Rejected for Quality Reasons”)	X	4.66.4.1
(113037, DCM, “Rejected for Patient Safety Reasons”)	X	4.66.4.2
(113038, DCM, “Incorrect Modality Worklist Entry”).	X	4.66.4.3
(113039, DCM, “Data Retention Policy Expired”)	X	4.66.4.4

**4.66.4.1 Rejection Note Stored (for Quality Reasons)**

**4.66.4.1.1 Trigger Events**

An operator at the Sender determines that certain images are of insufficient quality, requiring that they be rejected.

11670 **4.66.4.1.2 Message Semantics**

The message is a DICOM C-STORE of a Key Object Selection instance. The Sender is the SCU. The Receiver is the SCP.

11675 The Sender shall create a new Key Object Selection instance in a new Series of the rejected images' Study. Integration-critical values shall be filled as defined in the Evidence Document Attribute Mapping (RAD TF-2x: Appendix A.2). The instance shall be constructed as defined in DICOM PS3.3 and 3.4, and shall have:

- A Key Object Selection Document Title code of (113001, DCM, "Rejected for Quality Reasons").
- 11680 • At least one Document Title Modifier code. Unless otherwise specified by the profile invoking this transaction, the code(s) shall be drawn from [DICOM Context Group 7011](#).
- References to all rejected instances are specified as Content Items with value type of COMPOSITE, IMAGE or WAVEFORM in the Content Sequence (0040,A730).

This Key Object Selection instance shall be stored to the Receiver. It serves as a trigger to disallow routine use of these rejected instances that it references.

11685 **4.66.4.1.3 Expected Actions**

The Receiver receives the Key Object Selection instance and shall store it. The Receiver shall support the two behaviors listed below. The behavior chosen shall be configurable.

- 11690 • **Expose Rejected Instances:** For the Key Object Selection instance and all instances referenced therein, the Receiver shall return SOP Instance UIDs in Query Responses and the instances in Patient, Study, Series, or Instance level retrievals.
- 11695 • **Hide Rejected Instances:** For the rejected instances referenced in the Key Object Selection, the Receiver shall neither return SOP Instance UIDs in Query Responses nor return the instances in Patient, Study, Series, or Instance level retrievals. If the request includes optional Additional Query/Retrieve Attributes defined in Table 4.66.4.1.3-1, then the returned value(s) of the requested attributes shall reflect the absence of hidden rejected instances.

**Table 4.66.4.1.3-1: Additional Query/Retrieve Attributes**

Attribute Name	Tag
Number of Patient Related Studies	(0020,1200)
Number of Patient Related Series	(0020,1202)
Number of Patient Related Instances	(0020,1204)
Number of Study Related Series	(0020,1206)
Number of Series Related Instances	(0020,1209)
Number of Study Related Instances	(0020,1208)
Modalities in Study	(0008,0061)
SOP Classes in Study	(0008,0062)
Alternate Representation Sequence	(0008,3001)

For example, the following study has two original series and a Rejection Note for Quality Reason that references all instances in Series 2

- 11700
- Series 1: Modality = MR, 200 objects
  - Series 2: Modality = US, 80 objects
  - Series 3: Modality = KO (Rejection Note), 1 object (references all 80 objects in Series 2)

When the Receiver receives a C-FIND request for this study and the request specifies the additional Number of Study Related Series (0020,1206), Number of Study Related Instances (0020,1208) and Modalities in Study (0008,0061) attributes, then using the Expose Rejected Instances behavior, the Receiver will return the following result with respect to the additional Query/Retrieve attributes:

11705

**Table 4.66.4.1.3-2: Expose Rejected Instances Behavior - Example Attribute Values**

Attribute Name	Value
Number of Study Related Series	3
Number of Study Related Instances	281
Modalities in Study	MR \ US \ KO

- 11710 When using the Hide Rejected Instances behavior, the Receiver will return the following result with respect to the additional Query/Retrieve attributes:

**Table 4.66.4.1.3-3: Hide Rejected Instances Behavior - Example Attribute Values**

Attribute Name	Value
Number of Study Related Series	3 if empty series is returned, or 2 if empty series is not returned
Number of Study Related Instances	201
Modalities in Study	MR \ KO

- 11715 If the complete series is rejected according to the specified behavior as described above, then the Receiver may or may not return the empty series in the C-FIND response when it receives a SERIES level C-FIND request.

The Receiver shall provide two Application Entities for each C-FIND service and each C-MOVE service; one AE associated with the Regular Use behavior, and one AE associated with the Expose Rejected Instances behavior (see Section 4.66.4.1.3).

- 11720 The Receiver shall be configurable to restrict access to the Expose Rejected Instances Application Entity to a limited set of calling AE Titles.

## 4.66.4.2 Rejection Note Stored (for Patient Safety Reasons)

### 4.66.4.2.1 Trigger Events

An operator at the Sender determines that certain images or evidence documents are incorrect.

11725 **4.66.4.2.2 Message Semantics**

The message is a DICOM C-STORE of a Key Object Selection instance. The Sender is the SCU. The Receiver is the SCP.

The Sender shall be able to let a user correct one or more attributes in images that are displayed or in evidence documents that are applied.

- 11730
- The user shall be able to store new, corrected images or evidence documents at the Acquisition Modality as defined in Section 4.8.4.1.2 or at the Evidence Creator as defined in Section 4.18.4.1.2.

11735 The Sender shall create a new Key Object Selection instance in a new Series of the rejected instances' Study. Integration-critical values shall be filled as defined in the Evidence Document Attribute Mapping (RAD TF-2x: Appendix A.2). The instance shall be constructed as defined in DICOM PS3.3 and 3.4, and shall have:

- A Key Object Selection Document Title code of (113037, DCM, "Rejected for Patient Safety Reasons")
  - References to all incorrect instances and derived instances (e.g., FOR PRESENTATION and FOR PROCESSING) as Content Items with value type of COMPOSITE, IMAGE or WAVEFORM in the Content Sequence (0040,A730).
- 11740

This Key Object Selection instance shall be stored to the Receiver. It serves as a trigger to disallow routine use of these incorrect instances that it references.

**4.66.4.2.3 Expected Actions**

11745 The Receiver receives the Key Object Selection instance and shall store it.

The Receiver shall hide the referenced instances and specifically shall not provide these instances in responses to an image query/retrieve transaction [RAD-14, RAD-16] or presentation state query/retrieve transaction [RAD-15], [RAD-17].

11750 If the complete series is rejected, then the Receiver may or may not return the empty series in the C-FIND response when it receives a SERIES level C-FIND request.

**4.66.4.2.3.1 Additional Requirements for Image Manager/Archive in IOCM**

The Receiver shall not accept subsequent occurrence of instances that have been hidden.

**4.66.4.3 Rejection Note Stored (for Incorrect Modality Worklist)**

**4.66.4.3.1 Trigger Events**

11755 An operator at the Sender determines that certain images, typically just acquired and transmitted, are associated with an incorrect modality worklist entry.

#### **4.66.4.3.2 Message Semantics**

The message is a DICOM C-STORE of a Key Object Selection instance. The Sender is the SCU. The Receiver is the SCP.

- 11760 The Sender shall enable a user to associate one or more objects in the study with the correct modality worklist entry. The Sender shall create a new Key Object Selection instance in a new Series of the study referencing the rejected instances associated with the incorrect modality worklist entry. Integration-critical values shall be filled as defined in the Evidence Document Attribute Mapping (RAD TF-2x: Appendix A.2). The instance shall be constructed as defined in
- 11765 DICOM PS3.3 and 3.4, and shall have:
- A Key Object Selection Document Title code of (113038, DCM, “Incorrect Modality Worklist Entry”).
  - References to all instances associated with the incorrect modality worklist entry as Content Items with value type of COMPOSITE, IMAGE or WAVEFORM in the Content
- 11770 Sequence (0040,A730).

#### **4.66.4.3.3 Expected Actions**

The Receiver receives the Key Object Selection instance and shall store it.

- 11775 The Receiver shall hide the referenced instances and specifically shall not provide these instances in responses to an image query/retrieve transaction [RAD-14], [RAD-16] or presentation state query/retrieve transaction [RAD-15], [RAD-17].

The Receiver shall not accept subsequent occurrence of instances that have been hidden.

If the complete series is rejected, then the Receiver may or may not return the empty series in the C-FIND response when it receives a SERIES level C-FIND request.

#### **4.66.4.4 Rejection Note Stored (for Data Retention Expiry)**

##### **11780 4.66.4.4.1 Trigger Events**

A manual or automatic procedure in the Sender determines that certain instances exceed the required period of data retention and automatically deletes them locally and, [ based on configuration, determines that an external Image Manager/Archive (e.g., Centralized Archive) should be notified.

##### **11785 4.66.4.4.2 Message Semantics**

The message is a DICOM C-STORE of a Key Object Selection instance. The Sender is the SCU. The Receiver is the SCP.

- 11790 The Sender shall create a new Key Object Selection instance in a new Series for each study with the expired instances. Integration-critical values shall be filled as defined in the Evidence Document Attribute Mapping (RAD TF-2x: Appendix A.2). The instance shall be constructed as defined in DICOM PS3.3 and 3.4, and shall have:



- A Key Object Selection Document Title code of (113039, DCM, “Data Retention Policy Expired”).
- References to all instances within the study that have exceeded the required data retention period as Content Items with value type of COMPOSITE, IMAGE or WAVEFORM in the Content Sequence (0040,A730).

#### 4.66.4.4.3 Expected Actions

The Receiver receives the Key Object Selection instance and shall store it.

11800 The Receiver will decide, depending on its local data retention policies, whether to act and how to act. If it chooses to act, it may delete the referenced instances.

If the complete content of a series is deleted, the Receiver may or may not also delete the series itself.

11805 If the Receiver later receives instances that have been previously deleted due to the expiry of data retention period and not deleted due to other reasons, then the Receiver may choose to decide that the Data Retention Policy Expired rejection is no longer in force. If it so decides, it shall:

- store the instances as defined in one of the corresponding instance stored transactions ([RAD-8], [RAD-9], [RAD-18], [RAD-19], [RAD-29], [RAD-43], [RAD-61])
- return the referenced instances in subsequent query or retrieve requests, and
- not return the Rejection Note corresponding to the Data Retention Policy Expired rejection that is no longer in force

#### 4.67 Media Information Stored [RAD-67]

This transaction is currently in the [Extensions to PDI](#) Trial Implementation Supplement.

#### 11815 4.68 Provide and Register Imaging Document Set – MTOM/XOP [RAD-68]

##### 4.68.1 Scope

The Provide and Register Imaging Document Set – MTOM/XOP transaction passes a Repository Submission Request from an XDS-I Imaging Document Source to an XDS Document Repository.

11820 This transaction is derived from the [Provide and Register Document Set-b \[ITI-41\]](#) transaction of the IHE IT Infrastructure Technical Framework. It adds new document content types as well as additional semantics and constraints on the metadata defined in [ITI-41].

A Provide and Register Imaging Document Set – MTOM/XOP transaction carries:

- 11825
  - Metadata describing zero or more new documents (Metadata describing zero documents may be used to describe folders containing references to documents that were previously submitted)
  - Within metadata, one DocumentEntry object per document
  - One Submission Set definition along with the linkage to new documents and references to existing documents
- 11830
  - Zero or more Folder definitions along with linkage to new or existing documents.
  - Zero or more documents

#### 4.68.2 Actor Roles

**Actor:** Imaging Document Source

**Role:** Submits document(s) with associated metadata to an XDS Document Repository.

11835 **Actor:** Document Repository

**Role:** Receives documents and associated metadata and:

- Stores the documents
  - Augments submitted metadata with repository information to enable later retrieval of documents
- 11840
  - Forwards the enhanced metadata to the XDS Document Registry.

#### 4.68.3 Referenced Standards

For a list of the standards inherited from the underlying [Provide and Register Document Set-b \[ITI-41\]](#) transaction; see [ITI TF-2: 3.41.3](#).

In addition, the following standards are used to define the radiology-specific content:

11845 DICOM [PS3.3 Section A.35.4](#): Key Object Selection Document IOD (KOS)

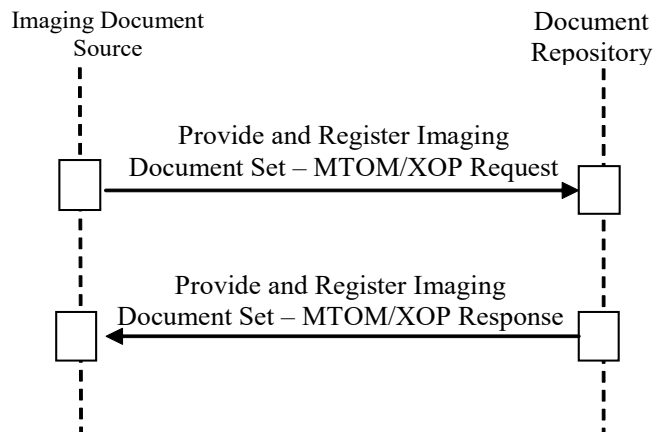
DICOM [PS3.16](#): Content Mapping Resource

DICOM [PS3.18 Section 10.4](#): Web Services - Retrieve Transaction of the DICOM Studies Service (also known as Web Access to DICOM Persistent Objects (WADO))

11850 PDF/A ISO 19005-1. Document management - Electronic document file format for long-term preservation - Part 1: Use of PDF (PDF/A)

HL7 CDA Release 2.0 (denoted HL7 CDA R2, or just CDA, in subsequent text)

HL7 Implementation Guide for CDA® Release 2: Imaging Integration; Basic Imaging Reports in CDA and DICOM; Diagnostic Imaging Reports (DIR) – Universal Realm, Release 1, March 2009.

11855 **4.68.4 Messages****Figure 4.68.4-1: Interaction Diagram****4.68.4.1 Provide and Register Imaging Document Set – MTOM/XOP Request message**

11860 An Imaging Document Source sends documents and associated metadata to a Document Repository. This message is an extension of the Provide and Register Document Set-b [ITI-41] transaction as defined in [ITI TF-2: 3.41](#).

**4.68.4.1.1 Trigger Events**

The triggers for this transaction are:

- 11865
- The Imaging Document Source is instructed to submit a set of one or more new imaging documents for sharing, or
  - A previously submitted document or the contents of a previously submitted manifest changes, requiring the Imaging Document Source to submit an update.

**4.68.4.1.2 Message Semantics**

11870 This transaction extends the message semantics of the Provide and Register Document Set-b [ITI-41] transaction by specifying additional document content types, to allow the sharing of the following types of documents:

1. Sets of DICOM SOP instances
2. Imaging diagnostic reports

11875 To support these content types and their usage, additional requirements and constraints on the Document Sharing Metadata are specified.

The Provide and Register Imaging Document Set – MTOM/XOP Request message semantics are specified in the following subsections:

1. Sharing of Persistent DICOM Instances via a Manifest document
- 11880 2. Sharing of radiology diagnostic report in PDF or CDA Structured or CDA Wrapped Text formats
3. XDS-I.b Document Sharing Metadata bindings
4. Use of the Document Sharing Submission Set concept in sharing of radiology imaging information.

11885 The wsdl definition for this Provide-and-Register transaction sent by the XDS-I Imaging Document Source is no different than the Provide-and-Register transaction sent by the XDS.b Document Source in [ITI-41]. An informative wsdl definition for the Provide-and-Register transaction can be found online at: [XDS.b\\_DocumentRepository.wsdl](#).

#### **4.68.4.1.2.1 Sharing of Set of DICOM Instances**

11890 The XDS-I Imaging Document Source creates a manifest that describes and collects references to DICOM SOP instances that are intended for sharing. The manifest, a Key Object Selection (KOS) Document Instance, is the actual document provided to the XDS Document Repository and registered at the XDS Document Registry.

11895 As specified in IHE ITI XDS.b Integration Profile, the structure of the message between the XDS Document Source and the XDS Document Repository is an MTOM/ XOP formatted message. In this transaction, the source actor is the XDS-I Imaging Document Source, but the above requirement still applies. The KOS Document Instance is encoded in the message as a DICOM Part 10 File format having a MIME type of “application/dicom”.

11900 The Imaging Document Source shall ensure that the DICOM SOP Instances referenced from within the manifest are available to be retrieved.

11905 If the XDS-I Imaging Document Source makes one or more SOP Instances unavailable that are referenced in a published manifest, then it shall submit a new manifest as a replacement for the published manifest already in the XDS Document Repository and XDS Document Registry (see [ITI TF-3: 4.2.2.2](#) “Document Relationships”). The new manifest shall have the updated list of DICOM SOP Instances with the unavailable instances removed. If the XDS-I Imaging Document Source makes all referenced DICOM SOP Instances unavailable in a published manifest, then it may consider implementing the Remove Imaging Document Option (see RAD TF-1: 18.2.5).

#### **4.68.4.1.2.1.1 Manifest KOS Document**

11910 The references to the DICOM SOP Instances shall be included in the Current Requested Procedure Evidence Sequence (0040,A375) attribute of the KOS Manifest Document.

The Imaging Document Source shall support a number of attributes in Current Requested Procedure Evidence Sequence (0040,A375), which are represented in the Hierarchical SOP Instance Reference Macro, as described in the following table:

11915

**Table 4.68.4.1.2.1.1-1: Attributes of Hierarchical SOP Instance Reference Macro in KOS Manifest Document**

Attribute Name	Tag	Imaging Document Source
Study Instance UID	(0020,000D)	R
Referenced Series Sequence	(0008,1115)	R
> Series Instance UID	(0020,000E)	R
> Retrieve AE Title	(0008,0054)	R+
> Retrieve Location UID	(0040,E011)	R+
> Retrieve URL	(0008,1190)	O (Note 1,2)
> Storage Media File-Set ID	(0088,0130)	O
> Storage Media File-Set UID	(0088,0140)	O
> Referenced SOP Sequence	(0008,1199)	R
>> Referenced SOP Class UID	(0008,1150)	R
>> Referenced SOP Instance UID	(0008,1155)	R

Note 1: An Imaging Document Source that supports the “DICOM Retrieve by WADO-RS” Option (RAD TF-1: 18.2.7) shall include a value for Retrieve URL (0008,1190) that is the endpoint for retrieving the DICOM instances using WADO-RS Retrieve [RAD-107].

11920

Note 2: An Imaging Document Source does not use the Retrieve URL (0008,1190) attribute for the WADO-URI endpoint for the WADO Retrieve [RAD-55] transaction. See RAD TF-2x: G.2.

11925

Some of these requirements build on attributes which are Type 2 or Type 3 in DICOM (such attributes are indicated with R+). Specifically, the Imaging Document Source shall include its own identification in the Retrieve AE Title (0008,0054) and Retrieve Location UID (0040,E011) attributes, and Retrieve URL (0008,1190) if “DICOM Retrieve by WADO-RS” Option is supported. These attributes will enable subsequent retrieval of the DICOM objects referenced within the KOS manifest.

#### 4.68.4.1.2.2 Sharing of Report

11930

Since text reports address many of the weaknesses of PDF reports and vice versa, it is required that the Imaging Document Source shall support shared reports in at least one of the following three formats:

- CDA Imaging Report with Structured Headings
- CDA Wrapped Text Report
- PDF Report

To maximize interoperability of the chosen formats:

11935

- For a PDF Report:
  - A specific PDF version is not specified, but use of PDF/A (ISO 19005-1) is recommended.
- For a CDA Imaging Report with Structured Headings:

- 11940
- The CDA R2 Header and Body shall conform to the HL7 Clinical Document Architecture Release 2.0. The report content shall be encoded in the StructuredBody element and shall use Section elements identified with a code and there shall be no nonXMLBody element. It is recommended that the CDA R2 Body also conform to the “HL7 Standard for CDA® Release 2: Imaging Integration; Basic Imaging Reports in CDA and DICOM, Release 1”.
- 11945
- For a CDA Wrapped Text Report:
    - The CDA R2 Header shall conform to the HL7 Clinical Document Architecture Release 2.0. The CDA Body shall be text encoded with UTF-8 UNICODE format. Refer to Section 4.68.4.1.2.3.5 for constraints on the CDA wrapper.

11950 A report (no matter what document format is chosen) can be shared with or without image reference(s).

If a shared report includes image reference(s), it can embed selected images in its PDF format or it can include fully resolved hyperlinks that point to the selected images; these hyperlinks can be interactively clickable (e.g., PDF) or can be processed or copied (e.g., text).

11955 The Imaging Document Source that provides and registers the shared report is responsible for formatting the hyperlink to reference relevant images. The referenced images within a shared imaging report are meant to be accessed without the need for specialized (e.g., DICOM) viewing applications.

11960 The hyperlink that references the selected image shall be formatted as a DICOM WADO URI. Since the sharing environment is inherently cross-enterprise, the secured version of HTTP (i.e., HTTPS) shall be used when formatting the hyperlink.

The Imaging Document Source is required to ensure that image references are valid links.

11965 Even though significant images can be shared as non-DICOM format (embedded picture in PDF report or hyperlinks in PDF or Text report), it is required that sharing of a large set of DICOM images be achieved by sharing a set of DICOM SOP instances by providing and registering a manifest document. This is to avoid registration of a large number of individual documents in the XDS Document Registry.

#### **4.68.4.1.2.3 Document Sharing Metadata**

11970 The Provide and Register Imaging Document Set – MTOM/XOP Request message shall include the metadata attributes that will be forwarded by the Document Repository to the XDS Document Registry using the [Register Document Set-b \[ITI-42\]](#) transaction.

The Imaging Document Source supplies all necessary metadata attributes of a DocumentEntry.

#### **4.68.4.1.2.3.1 Metadata Attributes: Author Information and Document Creation Time**

11975 In XDS, a registered document directly contains the clinical information of interest for sharing. Therefore, its metadata for registration can be populated directly from the document content. For

example, a discharge letter is submitted to the XDS Document Repository, so its author and creation information is populated into the Document metadata.

11980 In XDS-I.b, the Manifest document submitted to the XDS Document Repository usually does not directly constitute clinical information of interest for sharing, but rather is a set of references to such clinical information. Thus, the metadata of the Manifest document shall be related to the referenced source content or its creation process, to reflect the clinical nature of the shared information. This affects the metadata attributes including, but not limited to, author (and sub-attributes authorSpecialty, authorInstitution, authorPerson, authorRole), creationTime, and title.

11985 If the Manifest references source data from multiple authors, then one primary author, source data creation time and document title shall be chosen. Note that this metadata shall be populated from the part of the source data that most closely represents the main content for sharing in order to best support a user query to the XDS Document Registry for finding this data. For example, a Manifest referencing a current report and study as well as a prior report and study, will register metadata populated from the current report (which is the clinical content of interest for sharing).

11990 In cases where the data to be shared is transformed from its original format (e.g., DICOM) to another format (e.g., PDF) in advance of sending it to the XDS Document Repository, the metadata of such newly generated shared information shall be populated from the original source data (e.g., DICOM data).

11995 In summary, XDS-I.b Document Sharing Metadata always reflects the main clinical content of a shared document, which may be described directly in the document, or in the source data referenced within the document, or in the source data from which the document is transformed.

#### 4.68.4.1.2.3.2 DocumentEntry Metadata

12000 Table 4.68.4.1.2.3-1 lists Document Sharing DocumentEntry metadata attributes that are either further constrained by XDS-I.b, or have XDS-I.b specific instructions for how the XDS-I Imaging Document Source is expected to populate them. Unless otherwise specified, the “optionality” of the attributes listed in the table below is the same as required for the XDS Document Source.

For a full description of all the metadata attributes associated with a Document Sharing document, see [ITI TF-3: Table 4.2.3.2-1](#) “DocumentEntry Metadata Attribute Definition”.

12005 **Table 4.68.4.1.2.3-1: XDS-I.b-specific Metadata Requirements**

DocumentEntry Metadata Attribute	XDS-I.b-specific Requirements
creationTime	This attribute value shall be populated by the XDS-I Imaging Document Source to record the date and time at which the clinical content conveyed in the shared document is created. If the published document is a DICOM object or is transformed from a DICOM information object, this attribute value should be taken from the tags Instance Creation Date (0008,0012) and Instance Creation Time (0008,0013) of the DICOM object.
eventCodeList	This attribute is required to be included in the metadata if known by the XDS-I Imaging Document Source. In other words, it is “promoted” from an optional (O) attribute in XDS to a “required if known” (R2) attribute in XDS-I.b.

DocumentEntry Metadata Attribute	XDS-I.b-specific Requirements
	<p>This attribute shall be populated by the Imaging Document Source to describe both the Acquisition Modality and Anatomic Region.</p> <ul style="list-style-type: none"> <li>Acquisition Modality: The eventCodeList shall contain a code from the DICOM Content Mapping Resource DICOM <a href="#">PS3.16 Context Group CID 29</a> for each distinct acquisition modality with which images were acquired in the study. In cases where a study contains images from multiple acquisition modalities, multiple codes shall be included in the eventCodeList. Each modality code’s displayName shall be populated with the corresponding Code Meaning text from Context Group CID 29.</li> </ul> <p>Notes:</p> <p>The XDS-I Imaging Document Source needs to consider all series in the Submission Set to determine the complete set of modality codes.</p> <p>The Acquisition Modality (0008,0060) attribute for some objects in the study may contain values that do not represent imaging modalities (e.g., SR, Presentation States, Segmentations, etc.). There is no corresponding entry for these values in CID 29 and these values shall not be represented in the eventCodeList.</p> <ul style="list-style-type: none"> <li>Anatomic Region: the eventCodeList shall contain code(s) from the DICOM Content Mapping Resource DICOM <a href="#">PS3.16 Context Group CID 4</a>. Each anatomic region code’s displayName shall be populated with the corresponding Code Meaning text from Context Group CID 4.</li> </ul> <p>For example, for a lung CT study which contains 3 CT acquisition series, one SR series, and one Segmentation series, will have a two entries in eventCodeList: a single entry for Acquisition Modality using the code triplet “(CT, DCM, Computed Tomography) and an entry for Anatomic Region using the code triplet; “(39607008, SCT, Lung)”.</p> <p>See Note 1.</p>
formatCode	<p>This attribute shall be populated by the XDS-I Imaging Document Source as follows:</p> <ul style="list-style-type: none"> <li>Shall use “1.2.840.10008.5.1.4.1.1.88.59” (DICOM KOS SOP Class UID) as the Format Code Value and “1.2.840.10008.2.6.1” (DICOM UID Registry UID) as the Format Coding Scheme OID for a DICOM Manifest document.</li> <li>Shall use “urn:ihe:rad:TEXT” for a CDA Wrapped Text Report</li> <li>Shall use “urn:ihe:rad:PDF” for a PDF Report</li> <li>Shall use “urn:ihe:rad:CDA:ImagingReportStructuredHeadings:2013” for a CDA Imaging Report with Structured Headings unless overridden by a requirement in a Content Profile (such as IHE Cardiology CIRC or CRC).</li> </ul>
mimeType	<p>This attribute shall be populated by the XDS-I Imaging Document Source from one of the following values:</p> <ul style="list-style-type: none"> <li>“application/dicom” for a DICOM Manifest document</li> <li>“text/xml” for a CDA Wrapped Text Report</li> <li>“text/xml” for a CDA Imaging Report with Structured Headings</li> <li>“application/pdf” for a PDF Report</li> </ul>
practiceSettingCode	<p>This attribute shall be populated by the XDS-I Imaging Document Source describe the high-level imaging specialty such as (309964003, SCT, “Radiology”), (309950003, SCT, “Pathology”), or (309915006, SCT, “Cardiology”). The list of acceptable values is constrained by the organization managing the XDS Document Registry (i.e., the XDS Affinity Domain).</p> <p>It is strongly recommended to use the values from the DICOM Content Mapping Resource DICOM <a href="#">PS3.16 Context Group CID 7030</a>.</p> <p>See Note 1.</p>
referenceIdList	<p>The list items can describe both the Accession Number and Study Instance UID.</p> <p>The Data Type for referenceIdList is CXi, as specified in <a href="#">ITI TF-3: Table 4.2.3.1.7-2</a>.</p>



DocumentEntry Metadata Attribute	XDS-I.b-specific Requirements
	<p><b>Accession Number:</b>                      The Accession Number identifies the Imaging Service Request. The Accession Number value may be found in the Originating HL7 Imaging Order Message (OMI) Imaging Procedure Control (IPC) Segment, Sequence 1 for Accession Identifier, or in the DICOM attribute Accession Number (0008,0050).                      The referencIdList may be populated with the Accession Number and assigning authority. Only the CXi.1, CXi.4 and CXi.5 components shall be valued. For DICOM mapping, see Section 4.68.4.1.2.3.3.5.                      The referencedIdList may contain multiple entries for Accession Number, e.g., for images from a grouped acquisition or when images are acquired and read in different facilities.</p> <p><b>Study Instance UID:</b>                      The Study Instance UID uniquely identifies an imaging study.                      Only the CXi.1 and CXi.5 components shall be valued:</p> <ul style="list-style-type: none"> <li>• CXi.1 - shall be the Study Instance UID</li> <li>• CXi.5 – shall be urn:ihe:iti:xds:2016:studyInstanceUID.</li> </ul> <p>An example encoding two Accession Numbers and a Study Instance UID in the referenceIdList is as follows:                      &lt;rim:Slot name="urn:ihe:iti:xds:2013:referenceIdList "&gt;                      &lt;rim:ValueList&gt;                      &lt;rim:Value&gt;                      642356235^^^&amp;amp;1.2.3.4.5.6&amp;amp;ISO^urn:ihe:iti:xds:2013:accession                      &lt;/rim:Value&gt;                      &lt;rim:Value&gt;                      STN-238432^^^&amp;amp;1.2.3.4&amp;amp;ISO^urn:ihe:iti:xds:2013:accession                      &lt;/rim:Value&gt;                      &lt;rim:Value&gt;                      2.16.5.4.3.2.1.0^^^urn:ihe:iti:xds:2016:studyInstanceUID                      &lt;/rim:Value&gt;                      &lt;/rim:ValueList&gt;                      &lt;/rim:Slot&gt;</p>
serviceStartTime	<p>This attribute shall be populated by the Imaging Document Source for a date and time that indicates the imaging service start time.                      As an example, the Imaging Document Source could take the value of Study Date (0008,0020) and Study Time (0008,0030) from the associated DICOM study</p>
sourcePatientInfo	<p>This attribute allows multiple values for different pieces of patient demographics. See ITI TF-3: 4, Metadata used in Document Sharing Profiles, and specifically Table 4.2.3.2-1 in <a href="#">ITI TF-3: 4.2.3.2</a>.                      As an example, this information can be transformed from DICOM Patient’s Name (0010,0010), Patient’s Birth Date (0010,0030), and Patient’s Sex (0010,0040).</p>
typeCode	<p>This attribute shall be populated by the XDS-I Imaging Document Source from a code in the Procedure Code Sequence (0008,1032) of the performed procedure with which the document is associated. In certain special cases previously defined in other IHE Profiles some sort of user intervention will be necessary to select the single Procedure Code used to populate this attribute. For example, handling the “Group Case” as defined in Scheduled Workflow will require the user to select a single, pre-coordinated procedure code that represents the multiple Requested Procedures that were acquired as a single study.</p>

DocumentEntry Metadata Attribute	XDS-I.b-specific Requirements
	<p>The coding system of the Radiology Imaging performed Procedure Code will be designated by the XDS Affinity Domain and shared by all XDS-I Imaging Document Sources in the XDS Affinity Domain.</p> <p>Note: As specified in RAD TF-2x: Appendix A, Table A.1-1, if the procedure is changed from the Requested Procedure Code Sequence (0032,1064), the Procedure Code Sequence (0008,1032) in the image is recommended to be absent or empty. Therefore, if the Procedure Code Sequence is absent, it is recommended that the Requested Procedure Code Sequence never be used because the procedure may have been altered.</p>
uniqueId	<p>This attribute shall contain the Document unique ID generated by the XDS-I Imaging Document Source. It shall be an ISO OID.</p> <p>For a DICOM Manifest document, this attribute value shall be the same as the SOP Instance UID of the corresponding DICOM KOS object. In the event that <b>any</b> information in the manifest changes and it needs to be resubmitted from the XDS-I Imaging Document Source to the XDS Document Repository, the XDS-I Imaging Document Source shall generate a new SOP Instance UID for the DICOM KOS object to ensure that its submission to the XDS Document Repository will succeed.</p> <p>For a CDA Imaging Report with Structured Headings or a CDA Wrapped Text Report, this value shall be formulated from the HL7 CDA R2 header as follows:  <i>ClinicalDocument/id@root.ClinicalDocument/id@extension</i></p>

Note 1: The specification for Coding Scheme in coded attributes in Document Sharing metadata permits use of either a Coding Scheme Designator (a short string such as SCT) or a Coding Scheme UID (an OID such as 2.16.840.1.113883.6.96). Thus, (39607008, SCT, “Lung”) is equivalent to (39607008, 2.16.840.1.113883.6.96, “Lung”).

See [ITI TF-3: 4.2.3.1.2](#) and [DICOM PS3.16 Table 8-1](#).

12010 Implementations may choose to support mapping from one to the other. Because senders of XDS-I metadata may use a Coding Scheme Designator or a Coding Scheme UID, recipients should be able to receive both.

#### 4.68.4.1.2.3.3 Transformation of DICOM VR to Document Sharing Metadata Data Types

12015 A number of Document Sharing metadata attributes use HL7 data types for value representation. Some of the metadata attributes may be transformed from data elements of the corresponding DICOM SOP Instance. In this section, transformations of DICOM VR (Value Representation) to the HL7 data types used in Document Sharing metadata are described.

12020 Note that term HL7 Data Type in the following transformations refers to their specified usage in Document Sharing metadata as defined in [ITI TF-3: 4.2.3.1.7](#) “Metadata Attribute Data types”.

##### 4.68.4.1.2.3.3.1 CX – Extended Composite ID

Table 4.68.4.1.2.3-2 describes the transformation of data element of DICOM VR to CX data type as specified in [ITI TF-3: 4.2.3.1.7](#) “Metadata Attribute Data Types”.

**Table 4.68.4.1.2.3-2: CX Data type mapping**

<b>CX Data Component</b>	<b>Component Name</b>	<b>DICOM VR</b>	<b>Comment</b>
1	ID Number	LO	This attribute represents the value of Patient ID issued by an Assigning Authority as indicated in component 3. In DICOM, it is data element (0010,0020) when used with sourcePatientId.
4.2	Assigning Authority – Universal ID	UT	This attribute represents the universal or unique identifier for the Patient ID Assigning Authority. In DICOM it is data element of the Issuer of Patient ID Qualifiers Sequence (0010,0024) >Universal Entity ID (0040,0032) when used with sourcePatientId. If this attribute is not present or the Assigning Authority – Universal ID Type is not ISO, then the XDS-I Imaging Document Source shall use its local configuration to populate this subcomponent, to indicate the Patient ID Domain, from which the Patient ID value in component 1 has been issued. This component shall be an ISO OID
4.3	Assigning Authority – Universal ID Type	CS	This component represents the standard defining the format of the Universal Entity ID. In DICOM it is data element of the Issuer of Patient ID Qualifiers Sequence (0010,0024) >Universal Entity ID Type (0040,0033). If this attribute is not present or the Assigning Authority – Universal ID Type is not ISO, then the XDS-I Imaging Document Source shall use its local configuration to populate this subcomponent, to indicate the Patient ID Domain, from which the Patient ID value in component 1 has been issued. This component shall be “ISO”

12025

HL7 CX data components not listed in the table are not used in Document Sharing metadata and shall be left empty.

#### **4.68.4.1.2.3.3.2 DTM – Date / Time**

HL7 DTM Data Type can be represented in the following regular expression:

12030           YYYY[MM[DD[HH[MM[SS]]]]]

This can be transformed from DICOM elements of VR DA (format: YYYYMMDD) and TM (format: HHMMSS.fraction).

#### **4.68.4.1.2.3.3.3 XCN – Extended Composite ID Number and Name for Person**

12035           Table 4.68.4.1.2.3-3 describes the transformation of DICOM VR of PN to XCN data type as specified for Document Sharing metadata:

**Table 4.68.4.1.2.3-3: XCN Data type mapping**

XCN Data Component	Component Name	DICOM Data Element	Comment
1	ID Number		The XDS-I Imaging Document Source shall use its local configuration or personnel directory service to populate this component.
2	Family Name	1st Component of PN	An example of transcoding a data element of VR PN into XCN, is when (0008,1070) Operator's Name is used for authorPerson and (0010,0010) is used for Patient Name
3	Given Name	2nd Component of PN	
4	Second or Further Given Names or Initials thereof	3rd Component of PN	
5	Suffix	5th Component of PN	
6	Prefix	4th Component of PN	
7	Degree		This attribute component is not included in DICOM.

HL7 XCN data components not listed in the table are not used in Document Sharing metadata and shall be left empty.

#### 4.68.4.1.2.3.3.4 XON – Extended Composite Name and Identification Number for Organization

12040

Table 4.68.4.1.2.3-4 describes the transformation of DICOM Data Elements to XON data type as specified for Document Sharing metadata:

**Table 4.68.4.1.2.3-4: XON Data type mapping**

XON Data Component	Component Name	DICOM VR	Comment
1	Organization Name	LO	Institution Name (0008,0080) or Institution Code Sequence (0008,0082) >Code Meaning (0008,0104)  If not populated, the XDS-I Imaging Document Source may use its local configuration to populate this component.
6.2	Assigning Authority Universal Id	SH	Institution Code Sequence (0008,0082) >Coding Scheme Designator (0008,0102) This component shall be an ISO OID. If not populated, the Imaging Document Source may use its local configuration to populate this component.
6.3	Assigning Authority Universal Id Type		Shall have the value "ISO" if XON.6.2 has a value
10	Organization Identifier	SH	Institution Code Sequence (0008,0082) >Code Value (0008,0104) The XDS-I Imaging Document Source may use its local configuration to populate this component.

12045 HL7 XON data components not listed in the table are not used in Document Sharing metadata and shall be left empty.

**4.68.4.1.2.3.3.5 CXi – Extended Composite ID of a Reference Object for Accession Number**

12050 Table 4.68.4.1.2.3-5 describes the transformation of data element of DICOM VR to CXi data type as specified in [ITI TF-3: Table 4.2.3.1.7-2](#) “Data Types”.

**Table 4.68.4.1.2.3-5: CXi Data type mapping**

CXi Data Component	Component Name	DICOM VR	Comment
1	ID Number	LO	Accession Number (0008,0050). For a grouped acquisition study, this field will be empty in the top level DataSet, but may be obtained from within Request Attributes Sequence (0040,0275)
4.2	Assigning Authority – Universal ID	UT	Issuer of Accession Number Sequence (0008,0051) >Universal Entity ID (0040,0032). If this attribute is not present or the Assigning Authority – Universal ID Type is not ISO, then the XDS-I Imaging Document Source shall use its local configuration to populate this subcomponent, to indicate the Assigning Authority, from which the Accession Number value in component 1 has been issued. This component shall be an ISO OID.
4.3	Assigning Authority – Universal ID Type	CS	Issuer of Accession Number Sequence (0008,0051) >Universal Entity ID Type (0040,0033). If this attribute is not present or the Assigning Authority – Universal ID Type is not ISO, then the XDS-I Imaging Document Source must use its local configuration to populate this subcomponent, to indicate the Assigning Authority, from which the Accession Number value in component 1 has been issued This component shall be “ISO”
5	Identifier Type Code	CS	Shall be “urn:ihe:iti:xds:2013:accession”

**4.68.4.1.2.3.4 Document Sharing Metadata Values represented as HL7 v2.5 Data Types**

12055 Document Sharing metadata that is represented as an HL7 v2.5 data type will require transformation from its corresponding HL7 CDA R2 header component. Table 4.68.4.1.2.3-6 guides this transformation and indirectly imposes requirements on the configuration of and/or user interaction with implementations supporting this transaction. Additionally, this table further restricts the HL7 CDA R2 specification. IDs in metadata that correspond to IDs in the CDA header (as II types) are required to have both a root and an extension attribute.

12060

**Table 4.68.4.1.2.3-6: HL7 v2.5 and CDA Data type mapping**

XDS/ XDS-I.b Metadata			HL7 CDA Header	
HL7 v2.5 Data Type	Subcomponent index	Subcomponent name	HL7 CDA R2 Data element	HL7 CDA R2 Sub-element or attribute
CX (see Note 1)			II	
	1	Id number	II	@extension
	4.2	AssigningAuthority. uid	II	@root
CXi (see Note 1)			II	
	1	Id number	II	@extension
	4.2	AssigningAuthority. uid	II	@root
DTM	1 (only)	Date/Time	TS or IVL_TS	@value (NOTE: format is compatible with DTM)
XCN			II and PN	
	1	Id number	II	@extension
	2.1	FamilyName.surnName	PN	Family
	3	Given Name	PN	Given
	4	Second (middle) Name	PN	Given
	5	Suffix	PN	Suffix
	6	Prefix	PN	Prefix
	9.2	AssigningAuthority. uid	II	@root
XON			II and ON	
	1	Organization Name		
	6.1	AssigningAuthority. namespace	II	@assigningAuthorityName
	6.2 (see Note 2)	AssigningAuthority. uid	II	@root
	6.3 (see Note 3)	Assigning Authority Universal Id Type	II	
	10	Organization Identifier	II	@extension

Note 1: See [ITI TF-3: Table 4.2.3.1.7-2](#) for restrictions on the formatting of the CX and CXi datatype.

Note 2: This field is required if XON.10 is valued and not an OID.

Note 3: This field is required if XON.10 is valued and not an OID and shall have the value "ISO".

#### 4.68.4.1.2.3.5 CDA Wrapper – CDA Wrapped Text Report Option

12065 This section outlines the content of the HL7 CDA R2 wrapper for the text content. We note here that requirements specified below are to ensure the presence of a minimum amount of wrapper data in order to enhance description and facilitate sharing of the document. It should be noted that the "nullFlavor" value expresses missing values in the CDA, e.g., it may be appropriate if such information cannot be derived from DICOM objects.

12070 Implementers of the “CDA Wrapped Text Report” Profile Option can and should make use of additional annotation within the CDA header to provide richer context. The examples in the following sections contain the minimal amount of wrapper data, as specified, and in many cases do make use of additional CDA header elements for enriched context.

12075 To the extent possible, the specification for the CDA wrapper for the report text has been made consistent with the CDA metadata specified in the ITI XDS Scanned Documents (XDS-SD) Profile (see [ITI TF-3: 5.2.2](#) and [5.2.3](#)) and has been replicated here for the readers’ convenience.

12080 Elements and attributes that apply to the XDS-SD use case(s) but not to the use case of sharing an electronically transmitted radiology report have been omitted, where allowed by the CDA R2 specification. Descriptions for how to populate certain elements and attributes consistent with the “sharing a text-based radiology report” use case have been included.

##### 4.68.4.1.2.3.5.1 Wrapper Format – HL7 CDA R2

The CDA metadata wrapper for plain text reports is the same as defined in the ITI XDS-SD Profile (see the metadata specification table in [ITI TF-3: 5.2.3](#)) with the exceptions described below and in the following subsections:

- 12085
- The ClinicalDocument/dataEnterer element, as it is defined in XDS-SD, does not apply to the report sharing use case and thus may be omitted.

##### 4.68.4.1.2.3.5.1.1 ClinicalDocument Child-less Elements

12090 The requirements for the ClinicalDocument Child-less elements for CDA-wrapped plain text reports is the same as defined in the ITI XDS-SD Profile (see [ITI TF-3: 5.2.3.1](#)), with the following exceptions/ clarifications:

- The ClinicalDocument/templateId element shall be 1.3.6.1.4.1.19376.1.2.21
- The ClinicalDocument/code element shall be set with the following attribute values:
  - code=“11528-7”
  - codeSystem=“2.16.840.1.113883.6.1”
  - 12095 ○ codeSystemName=“LOINC”
  - displayName=“Radiology Report”/>
- The ClinicalDocument/effectiveTime shall denote the time at which the CDA text document was recorded. At a minimum, the time shall be precise to the day and shall include the time zone offset from GMT.

12100 Example:

```
<ClinicalDocument xmlns="urn:hl7-org:v3">
  <typeId extension="POCD_HD000040" root="2.16.840.1.113883.1.3"/>
  <templateId root="1.3.6.1.4.1.19376.1.2.21">
  <id root="1.3.6.4.1.4.1.2835.2.7777"/>
  <code code="11528-7" codeSystem="2.16.840.1.113883.6.1"
    codeSystemName="LOINC" displayName="Radiology Report"/>
  <title>Chest X-Ray</title>
  <effectiveTime value="20050329224411+0500"/>
  <confidentialityCode code="N" codeSystem="2.16.840.1.113883.5.25"/>
  <languageCode code="en-US"/>
```

#### **4.68.4.1.2.3.5.1.2 ClinicalDocument/recordTarget**

12105 The requirements and example for the ClinicalDocument/recordTarget element for CDA-wrapped plain text reports is the same as defined in the ITI Cross-Enterprise Sharing of Scanned Documents (XDS-SD) Profile (see [ITI TF-3: 5.2.3.2](#)).

#### **4.68.4.1.2.3.5.1.3 ClinicalDocument/author (original)**

The requirements and example for the ClinicalDocument/author element (that represents the original author of the report) for CDA-wrapped plain text reports is the same as defined in the ITI XDS-SD Profile (see [ITI TF-3: 5.2.3.3](#)).

#### **12110 4.68.4.1.2.3.5.1.4 ClinicalDocument/author (reporting system)**

The requirements for the ClinicalDocument/author element (that represents the reporting system and software used to produce the report content) for CDA-wrapped plain text reports is the same as defined in the ITI XDS-SD Profile (see [ITI TF-3: 5.2.3.4](#)), with the following exceptions/clarifications:

- 12115
- When reading the XDS-SD specification, references to scanned, scanning, scanned content etc. refer to reporting, report content etc. in this context.
  - When reading the XDS-SD specification concerning the ClinicalDocument/author/assignedAuthor/assignedAuthoringDevice/code element references to CDA-wrapped PDF can be ignored since they do not apply to the radiology report sharing use case.
- 12120



Example:

```
<author>
  <time value="20050329224411+0500"/>
  <assignedAuthor>
    <templateId root="1.3.6.1.4.1.19376.1.2.20.2"/>
    <id root="1.3.6.4.1.4.1.2835.2.1234"/>
    <assignedAuthoringDevice>
      <code code="WSD" displayName="Workstation" codeSystem="
1.2.840.10008.2.16.4" />
      <manufacturerModelName>SOME REPORTING NAME AND MODEL
      </manufacturerModelName>
      <softwareName> REPORTING SOFTWARE NAME v0.0</softwareName>
    </assignedAuthoringDevice>
    <representedOrganization>
      <id root="1.3.6.4.1.4.1.2835.2"/>
      <name>SOME REPORTING Facility</name>
      <addr>
        <streetAddressLine>21 North Ave</streetAddressLine>
        <city>Burlington</city>
        <state>MA</state>
        <postalCode>01803</postalCode>
        <country>USA</country>
      </addr>
    </representedOrganization>
  </assignedAuthor>
</author>
```

#### **4.68.4.1.2.3.5.1.5 ClinicalDocument/custodian**

12125 The requirements and example for the ClinicalDocument/custodian element for CDA-wrapped plain text reports are the same as defined in the ITI XDS-SD Profile (see [ITI TF-3: 5.2.3.6](#)). Its context is left up to the reporting facility to define in accordance with local policies and to reflect the entity responsible for the report content. In most cases this will be the reporting facility.

#### **4.68.4.1.2.3.5.1.6 ClinicalDocument/legalAuthenticator**

12130 The requirements and example for the ClinicalDocument/legalAuthenticator element for CDA-wrapped plain text reports are the same as defined in the ITI XDS-SD Profile (see [ITI TF-3: 5.2.3.7](#)) and its context is left up to the reporting facility to define in accordance with local policies.

#### **4.68.4.1.2.3.5.1.7 ClinicalDocument/documentationOf**

12135 The requirements and example for the ClinicalDocument/documentationOf element for CDA-wrapped plain text reports are the same as defined in the ITI XDS-SD Profile (see [ITI TF-3: 5.2.3.8](#)).

#### 4.68.4.1.2.3.5.1.8 ClinicalDocument/component/nonXMLBody

12140 This ClinicalDocument/component/nonXMLBody element shall be present and used to wrap the text content. The requirements for the nonXMLBody are the same as defined in the ITI XDS-SD Profile (see [ITI TF-3: 5.2.3.9](#)), with the following exceptions/ clarifications:

- When reading the XDS-SD specification, references to scanned, scanning, scanned content etc. refer to reporting, report content etc. in this context.
- 12145 • When reading the XDS-SD specification concerning the ClinicalDocument/component/nonXMLBody element, references to CDA-wrapped PDF can be ignored since they do not apply to the radiology report sharing use case.
- 12150 • The XDS-SD specification requires Base 64 encoding for the value of the ClinicalDocument/component/nonXMLBody/text element, even if the unencoded text consists of characters that can be encoded legally within XML (i.e., ClinicalDocument/component/nonXMLBody/text@representation is required to be "B64" rather than "TXT"); currently, this XDS-SD requirement is not overridden, though it contrasts with the use of unencoded text in the CDA Imaging Report with Structured Headings Option, in which text occurs in various structured elements (e.g., component/TextObservation/text), rather than in a nonXMLBody element.

Example (report text content is in the same language as the wrapper):

```

<component>
  <nonXMLBody>
    <text mediaType="text/plain" representation="B64">
UmFkaW9sb2d5IFJlcG9ydCBmb3IgaSmFuZSBEB2UKQ29uY2xlc2l1vbjogTm9ybWFsLgo=
    </text>
  </nonXMLBody>
</component>
</ClinicalDocument>

```

12155

#### 4.68.4.1.2.4 Use of Document Sharing Submission Set

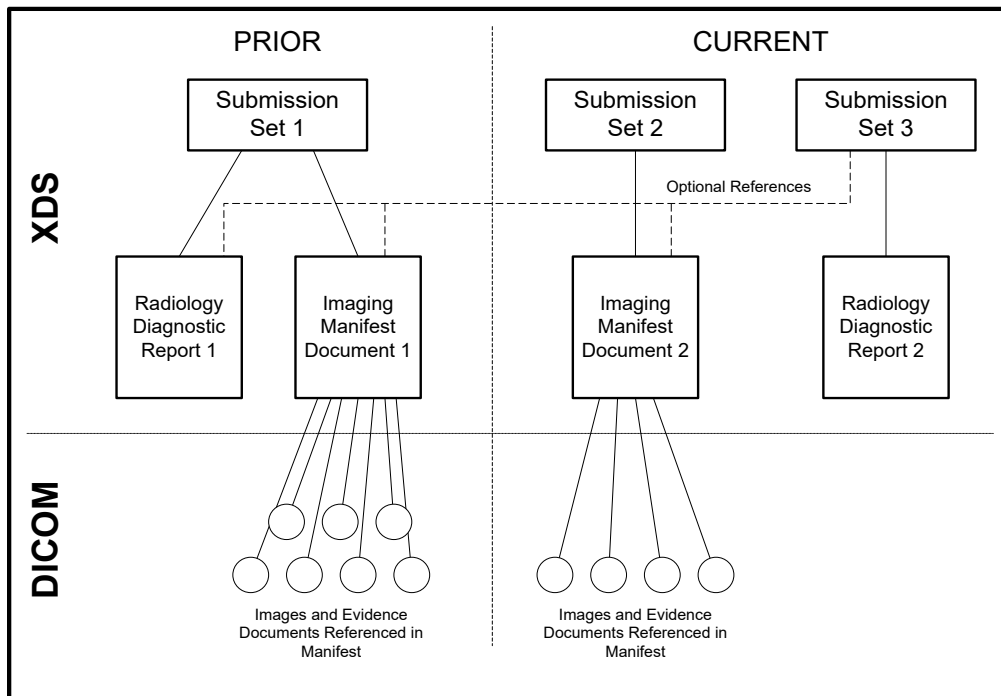
##### 4.68.4.1.2.4.1 Linking Report to Set of DICOM Instances

Figure 4.68.4.1.2.4-1 shows examples of three Submission Sets:

- 12160 • Submission Set 1 includes a report and a manifest that are stored in the XDS Document Repository. The manifest references DICOM instances that are archived in the Image Manager/Image Archive. The DocumentEntry.referenceIdList metadata attributes for the manifest and the report includes the same fully qualified Accession Number associated with the originating Requested Procedure for the prior.
- 12165 • Submission Set 2 includes one single manifest. The referenceIdList metadata attribute for the manifest includes the fully qualified Accession Number associated with the originating Requested Procedure for the current study.

12170

- Submission Set 3 includes a single report. The referenceIdList metadata attribute for the report includes the fully qualified Accession Number associated with the originating Requested Procedure for the current study, since it was generated by interpreting the images referenced by the manifest in Submission Set 2. Submission Set 3 references the manifest from Submission Set 2, and the report and manifest from Submission Set 1 since the earlier report, the images referenced by the earlier manifest, and images referenced by the current manifest were used for the interpretation.



12175

**Figure 4.68.4.1.2.4-1: Imaging Information Sharing Submission Set**

If the submitted reports and image manifests are for the same Requested Procedure, then the metadata for the report and for the image manifest may include the same fully qualified Accession Number in the referenceIdList. This will enable the unambiguous association of reports to the set of DICOM instances related to the Requested Procedure.

12180

**4.68.4.1.2.4.2 Linking Report to prior report**

A Submission Set containing a report can reference the manifest DocumentEntry for a set of images published in a prior submission if the prior images were used in creating the interpretation. Likewise, the new Submission Set can reference a report DocumentEntry from a previous submission. The Accession Number(s) of the prior images and reports will be different from the Accession Number(s) for the current images and reports.

12185

#### 4.68.4.1.3 Expected Actions

The Document Repository will receive this message and will process it according to the requirements specified in [ITI TF-2: 3.41.4.1.3](#).

#### 12190 4.68.4.2 Provide and Register Imaging Document Set – MTOM/XOP Response message

The XDS Document Repository sends a Provide and Register Imaging Document Set – MTOM/XOP Response message when the processing of a Provide and Register Imaging Document Set – MTOM/XOP Request message is complete. The specification of the trigger events, message semantics and expected actions are the same as those specified in [ITI TF-2: 3.41.4.2](#).

The conditions of failure and possible error messages are given in the ebRS standard. The XDS-I Imaging Document Source shall handle all error messages detailed for the Provide and Register Document Set-b [ITI-41] transaction in [ITI TF-3: Table 4.2.4.1-2](#) “Error Codes”.

### 4.69 Retrieve Imaging Document Set [RAD-69]

#### 12200 4.69.1 Scope

This transaction is used to retrieve DICOM instances that are referenced within an XDS-I.b DICOM manifest.

#### 4.69.2 Actor Roles

**Actor:** Imaging Document Consumer

12205 **Role:** requests a set of DICOM instances from an Imaging Document Source or from a remote community through an Initiating Imaging Gateway.

**Actor:** Responding Imaging Gateway

**Role:** requests a set of DICOM instances from Imaging Document Source(s) in its local community.

12210 **Actor:** Imaging Document Source

**Role:** returns requested DICOM instances.

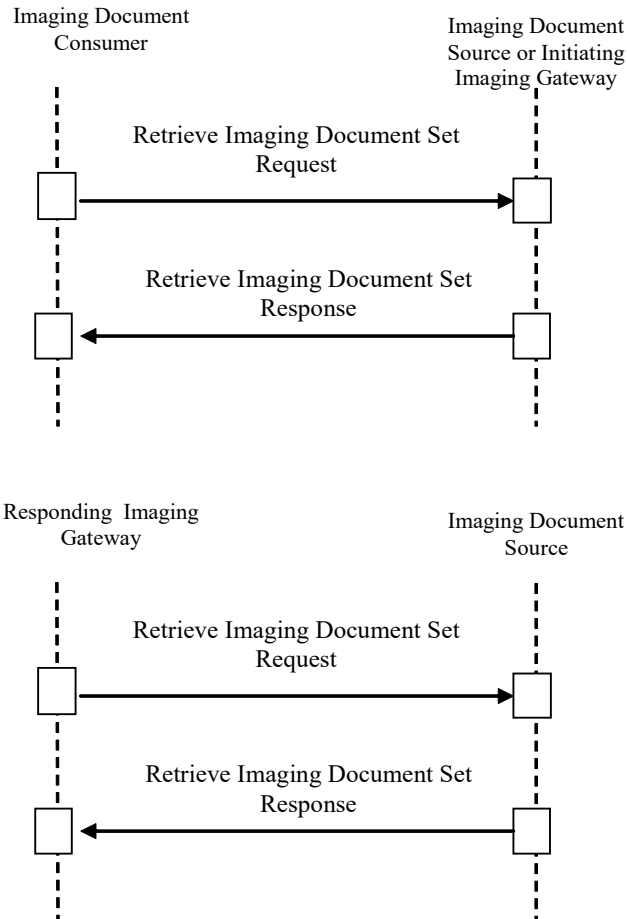
**Actor:** Initiating Imaging Gateway

**Role:** routes a request for DICOM instances to local Imaging Document Source(s) or a remote Responding Imaging Gateway.

#### 12215 4.69.3 Referenced Standards

For a list of the standards inherited from the underlying Retrieve Document Set [ITI-43] transaction, see [ITI TF-2: 3.43.3](#).

#### 4.69.4 Messages



12220

**Figure 4.69.4-1: Interaction Diagrams**

#### 4.69.4.1 Retrieve Imaging Document Set Request message

This message is an extension of the Retrieve Document Set transaction as defined in [ITI TF-2: 3.43](#).

12225

#### 4.69.4.1.1 Trigger Events

An Imaging Document Consumer wishes to retrieve a set of DICOM instances that are referenced within one or more DICOM Manifests; see Section 4.68.4.1.2.1 “Sharing a Set of DICOM instances”.

12230

An Initiating Imaging Gateway receives a Retrieve Imaging Document Set [RAD-69] request, and forwards it to one or more Imaging Document Source(s) in its community.

A Responding Imaging Gateway receives a Cross Gateway Retrieve Imaging Document Set [RAD-75] request and initiates a Retrieve Imaging Document Set request to the Imaging Document Source(s) in its community.

#### 4.69.4.1.2 Message Semantics

12235 The Retrieve Imaging Document Set messages is a SOAP 12 message in MTOM/XOP format; see Section 4.69.5 “Protocol Requirements”.

The Retrieve Imaging Document Set Request shall carry the following information:

- 12240 • A required repositoryUniqueId that identifies the Imaging Document Source from which the DICOM instance is to be retrieved. This value shall either be “computed” based on the Retrieve AE Title (0008,0054) attribute(s) present in the DICOM manifest or be populated from the Retrieve Location UID (0040,E011) attribute(s) that is present in the DICOM manifest. For a description of how this “computation” can be achieved, see RAD TF-2x: Appendix G.3.
- 12245 • A required list of one or more documentUniqueIds. These values correspond to the SOP Instance UIDs referenced within the DICOM manifest.
- A required list of one or more DICOM transfer syntax UIDs that the Imaging Document Consumer is capable of processing.
- A required Study Instance UID value that identifies the study containing the DICOM instances to be retrieved. The Study Instance UID is extracted from the DICOM manifest.
- 12250 • A required Series Instance UID value that identifies the series containing the DICOM images/ objects to be retrieved. The Series Instance UID is extracted from the DICOM manifest.
- A homeCommunityId that identifies the community holding the DICOM instances, required if:
  - 12255 ○ the Retrieve Imaging Document Set request is from an XCA-I Imaging Document Consumer to an XCA-I Initiating Imaging Gateway, or
  - the Retrieve Imaging Document Set request is from an XCA-I Responding Imaging Gateway to an Imaging Document Source in its community.

12260 The repositoryUniqueId and homeCommunityId associated with the requested DICOM instances can be different, allowing a single request to identify multiple Imaging Document Sources.

#### 4.69.4.1.3 Expected Actions

An Imaging Document Source shall generate a Retrieve Imaging Document Set Response message; see Section 4.69.4.2.

The Initiating Imaging Gateway:

- 12265 • shall initiate a [RAD-75] transaction to the Responding Imaging Gateway corresponding to the homeCommunityId value in the [RAD-69] request

- shall generate a Retrieve Imaging Document Set Response message; see Section 4.69.4.2

#### **4.69.4.2 Retrieve Imaging Document Set Response message**

##### **4.69.4.2.1 Trigger Events**

12270 This message is triggered by receipt of a Retrieve Imaging Document Set Request Message.

##### **4.69.4.2.2 Message Semantics**

The semantics of the Retrieve Imaging Document Set Response Message are identical to those inherited from the [ITI-43] transaction and are specified in [ITI TF-2: 3.43.4.2.2](#).

##### **4.69.4.2.3 Expected Actions**

12275 The Imaging Document Source or Initiating Imaging Gateway shall return the requested DICOM instances and a status code or an error code. The status codes, conditions of failure, and possible error messages are given in the ebRS standard and detailed in [ITI TF-3: Table 4.2.4.2-4](#) “[ITI-43] Retrieve Document Set and [ITI-39] Cross Gateway Retrieve Responses”.

12280 Note: A Responding Imaging Gateway may have suppressed failures resulting in the Initiating Imaging Gateway reporting a success.

The Imaging Document Source shall encode the pixel data using one of the DICOM transfer syntaxes included in the Retrieve Imaging Document Set Request Message. If the Imaging Document Source cannot encode the pixel data using any of the requested transfer syntaxes then an error status shall be returned.

12285 If the request contains a transfer syntax of 1.2.840.10008.1.2.4.94 (DICOM JPIP Referenced Transfer Syntax) or 1.2.840.10008.1.2.4.95 (DICOM JPIP Referenced Deflate Transfer Syntax), and the Imaging Document Source supports the requested transfer syntax, the following behavior is expected:

- 12290 • If the DICOM Image Object(s) already have the same JPIP transfer syntax as the one indicated in the request, the Retrieve Imaging Document Set Response shall include the DICOM Image Objects unchanged.
- 12295 • If the DICOM Image Object(s) have a transfer syntax that differs from that of the request, the Retrieve Imaging Document Set Response shall include the DICOM image with the transfer syntax changed to the requested transfer syntax. In addition, the pixel data Attribute (7Fe0,0010) tag will have been removed and replaced with a Pixel Data Provider URL (0028,7FE0) tag. The URL represents the JPIP request and will include the specific target information.
- 12300 • Upon receipt of this Retrieve Imaging Document Set Response, the Imaging Document Consumer may request the pixel data from the pixel data provider using the supplied URL. Additional parameters required by the application may be appended to the URL when accessing the pixel data provider.

- For example, a JPIP request for a 200 by 200 pixel rendition of the entire image can be constructed from the Pixel Data Provider URL as follows:
  - Pixel Data Provider URL (0028,7FE0) =  
12305       https://server.xxx/jpipserver.cgi?target=imgxyz.jp2,
  - URL Generated by the application =  
              https://server.xxx/jpipserver.cgi?target=imgxyz.jp2&fsiz=200,200

12310 In XCA-I, the Initiating Imaging Gateway can act as a JPIP proxy and accept the JPIP request from the Imaging Document Consumer and make the corresponding request to the Imaging Document Source. If a direct route is available from the Imaging Document Consumer to the Imaging Document Source, the Imaging Document Consumer is allowed to make a direct JPIP request to the Imaging Document Source, assuming security considerations are observed.

#### 4.69.4.3 Asynchronous Web Services Exchange Method

12315 An Image Document Consumer that supports the Asynchronous Web Services Option shall use the Asynchronous Web Services Exchange method if the Initiating Imaging Gateway also supports the Asynchronous Web Services Option.

The Initiating Imaging Gateway that supports the Asynchronous Web Services Option, shall respond to an Image Document Consumer using the use the Asynchronous Web Services Exchange method.

12320 A Responding Imaging Gateway shall use the Asynchronous Web Services Exchange method if the Image Document Source supports the Asynchronous Web Services Option.

The Image Document Source that supports the Asynchronous Web Services Option, shall respond to an Image Document Consumer using the Asynchronous Web Services Exchange method.

12325 The Image Document Consumer or the Responding Imaging Gateway supporting this method shall use the non-anonymous response EPR in the WS-Addressing replyTo header.

12330 The Initiating Imaging Gateway, Responding Imaging Gateway, the Image Document Source and the Image Document Consumer shall support the Asynchronous Web Services Methods in the [ITI TF-2: Appendix V](#): Web Services for IHE Transactions, which also includes additional considerations for implementers.

#### 4.69.5 Protocol Requirements

Implementers of this transaction shall comply with all requirements described in [ITI TF-2: Appendix V](#): Web Services for IHE Transactions.

12335 The Retrieve Imaging Document Set transaction shall use SOAP12 and MTOM with XOP encoding (labeled MTOM/XOP in this specification). See [ITI TF-2: Appendix V.8](#) for details.

The Imaging Document Source or Initiating Imaging Gateway shall:

- Accept the Retrieve Imaging Document Set Request message in MTOM/XOP format.



- Generate the Retrieve Imaging Document Set Response message in MTOM/XOP format

The Imaging Document Consumer shall:

- 12340
- Generate the Retrieve Imaging Document Set Request message in MTOM/XOP format.
  - Accept the Retrieve Imaging Document Set Response message in MTOM/XOP format.

### WSDL Namespace Definitions

iherad	urn:ihe:rad:xdsi-b:2009
ihe	urn:ihe:iti:xds-b:2007
rs	urn:oasis:names:tc:ebxml-regrep:xsd:rs:3.0
lcm	urn:oasis:names:tc:ebxml-regrep:xsd:lcm:3.0
query	urn:oasis:names:tc:ebxml-regrep:xsd:query:3.0

These are the requirements for the Retrieve Imaging Document Set transaction presented in the order in which they would appear in the WSDL definition:

- 12345
- The following types shall be imported (xsd:import) in the /definitions/types section:
    - namespace="urn:ihe:rad:xdsi-b:2009", schema="XDSI.b\_ImagingDocumentSource.xsd"
    - The baseline XDS.b schema (namespace="urn:ihe:iti:xds-b:2007", schema="XDS.b\_DocumentRepository.xsd")
- 12350
- The /definitions/message/part/@element attribute of the Retrieve Imaging Document Set Request message shall be defined as "iherad:RetrieveImagingDocumentSetRequest"
  - The /definitions/message/part/@element attribute of the Retrieve Imaging Document Set Response message shall be defined as "ihe:RetrieveDocumentSetResponse"
- 12355
- The /definitions/portType/operation/input/@wsaw:Action attribute for the Retrieve Imaging Document Set Request message shall be defined as "urn:ihe:rad:2009:RetrieveImagingDocumentSet"
  - The /definitions/portType/operation/output/@wsaw:Action attribute for the Retrieve Imaging Document Set Response message shall be defined as "urn:ihe:iti:2007:RetrieveDocumentSetResponse"

12360 These are the requirements that affect the wire format of the SOAP message. The other WSDL properties are only used within the WSDL definition and do not affect interoperability. Full sample request and response messages are in Section 4.69.5.1 Sample SOAP Messages.

12365 For informative WSDL for the Imaging Document Source and Responding Imaging Gateway see an example on the IHE Google Drive under [IHE Documents > TF Implementation Material > Rad.](#)

The <iherad:RetrieveImagingDocumentSetRequest/> element for use with the Retrieve Imaging Document Set Request Message is defined as:

- 12370 • One or more <iherad:StudyRequest/> elements each of which includes a “studyInstanceUID” attribute identifying the study associated with the DICOM images/ objects being retrieved. Each <iherad:StudyRequest/> element shall contain:
  - One or more <iherad:SeriesRequest/> elements each of which includes a “seriesInstanceUID” attribute identifying the series associated with the DICOM images/ objects being retrieved. Each <iherad:SeriesRequest/> element shall contain:
    - 12375 ▪ One or more <ihe:DocumentRequest/> elements, each one representing an individual document that the Imaging Document Consumer or Responding Imaging Gateway wants to retrieve from the Imaging Document Source. Each <ihe:DocumentRequest/> element contains:
      - 12380 • A required <ihe:RepositoryUniqueId/> element that identifies the Imaging Document Source from which the document is to be retrieved. This value corresponds to XDSDocumentEntry.repositoryUniqueId.
      - A required <ihe:DocumentUniqueId/> element that identifies the document within the Imaging Document Source. This value corresponds to the SOP Instance UID referenced within the DICOM manifest.
      - 12385 • A conditionally required <ihe:HomeCommunityId/> element that corresponds to the home attribute of the Identifiable class in eBRIM. The element shall be populated if the request is to an Initiating Imaging Gateway. Otherwise, it may be absent.
  - A required <iherad:TransferSyntaxUIDList/> element which contains a list of one or more <ihe:TransferSyntaxUID> elements. Each of the <iherad:TransferSyntaxUID> elements represent one of the transfer syntax encodings that the Imaging Document Consumer is capable of processing.

This allows the Imaging Document Consumer to specify one or more documents to retrieve from the Imaging Document Source or Initiating Imaging Gateway.

- 12395 The <ihe:RetrieveDocumentResponse/> element for use with the Retrieve Imaging Document Set Response Message is defined as:

- A required /ihe:RetrieveDocumentSetResponse/rs:RegistryResponse element
- A conditionally required sequence, if a matching document exists with <ihe:DocumentResponse/> elements containing:
  - 12400 ○ A conditionally required <ihe:HomeCommunityId/> element. The value of this element shall be the same as the value of the /RetrieveImagingDocumentSetRequest/StudyRequest/SeriesRequest/DocumentRequest/HomeCommunityId element in the Retrieve Document Set Request Message. If the <ihe:HomeCommunityId/> element is not present in the Retrieve Document Set Request Message, this value shall not be present.

- 12405      ○ A required `<ihe:RepositoryUniqueId/>` that identifies the Imaging Document Source from which the document is to be retrieved. The value of this element shall be the same as the value of the `/RetrieveImagingDocumentSetRequest/StudyRequest/SeriesRequest/DocumentRequest/RepositoryUniqueId` element in the original Retrieve Imaging Document Set Request Message. This value corresponds to RetrieveLocation UID in the DICOM manifest.
- 12410
- 12415      ○ A required `<ihe:DocumentUniqueId/>` that identifies the document within the Imaging Document Source. The value of this element shall be the same as the value of the `/RetrieveImagingDocumentSetRequest/StudyRequest/SeriesRequest/DocumentRequest/DocumentUniqueId` element in the original Retrieve Imaging Document Set Request Message. This value corresponds to the SOP Instance UID referenced within the DICOM manifest.
- 12420      ○ A required `<ihe:Document/>` element that contains the retrieved document as an XOP Infoset.
- A required `<ihe:mimeType/>` element that indicates the MIME type of the retrieved document

The `/RetrieveDocumentSetResponse/rs:RegistryResponse/@status` attributes provides the overall status of the request: It shall contain one of the following values:

- 12425      `urn:oasis:names:tc:ebxml-regrep:ResponseStatusType:Success`  
             `urn:ihe:iti:2007:ResponseStatusType:PartialSuccess`  
             `urn:oasis:names:tc:ebxml-regrep:ResponseStatusType:Failure`

See [ITI TF-3: Table 4.2.4.2-4](#) “[ITI-43] Retrieve Document Set and [ITI-39] Cross Gateway Retrieve Responses” for the interpretation of these values.

- 12430      For each document requested in a `/RetrieveImagingDocumentSetRequest/StudyRequest/SeriesRequest/DocumentRequest` element:
- If a warning is reported when retrieving the document, then a `/RetrieveDocumentSetResponse/rs:RegistryResponse/rs:RegistryErrorList/rs:RegistryError` element shall be returned with:
    - 12435      ○ `@severity` is `urn:oasis:names:tc:ebxml-regrep:ErrorSeverityType:Warning`
    - `@errorCode` is specified
    - `@codeContext` contains the warning message
    - `@location` contains the `DocumentUniqueId` of the document requested
  - The document shall be returned in an instance of `/RetrieveDocumentSetResponse/DocumentResponse/Document` as an XOP Infoset. The returned document and warning are correlated via the `DocumentUniqueId`.
- 12440

- If an error is reported when retrieving a document, then a /RetrieveDocumentSetResponse/rs:RegistryResponse/rs:RegistryErrorList/rs:RegistryError element shall be returned with:
  - 12445 ○ @severity is urn:oasis:names:tc:ebxml-regrep:ErrorSeverityType:Error
  - @errorCode is specified
  - @codeContext contains the error message
  - @location contains the DocumentUniqueId of the document requested
- No corresponding RetrieveDocumentSetResponse/DocumentResponse element shall be returned
  - 12450
  - If the document is successfully retrieved (without warning) then no /RetrieveDocumentSetResponse/rs:RegistryResponse/rs:RegistryErrorList/rs:RegistryError element shall be present and a /RetrieveDocumentSetResponse/DocumentResponse/Document element shall be returned containing the document as an XOP Infoset.
  - 12455

The /RetrieveDocumentSetResponse/rs:RegistryResponse/rs:ResponseSlotList element is not used in this transaction.

The /RetrieveDocumentSetResponse/rs:RegistryResponse/@requestId attribute is not used in this transaction.

- 12460 A full XML Schema Document for the XDS.b and XDS-I.b types is available online at: the IHE Google Drive under [IHE Documents > TF\\_Implementation\\_Material > Rad](#) (for XDS-I.b) and the IHE Google Drive under [IHE Documents > TF\\_Implementation\\_Material > ITI](#) (for XDS.b).

#### 4.69.5.1 Sample SOAP Messages

- 12465 The samples in the following two sections show a typical SOAP request and its relative SOAP response. The sample messages also show the WS-Addressing headers <Action/>, <MessageID/>, <ReplyTo/>...; these WS-Addressing headers are populated according to the [ITI TF-2: Appendix V: Web Services for IHE Transactions](#). The body of the SOAP message is omitted for brevity; in a real scenario the empty element will be populated with the appropriate metadata.

- 12470 Samples presented in this section are also available in the IHE Google Drive under [IHE Documents > TF\\_Implementation\\_Material > Rad](#).

##### 4.69.5.1.1 Sample Retrieve Imaging Document Set SOAP Request

###### 4.69.5.1.1.1 Synchronous Web Services Exchange

- 12475

```
<?xml version="1.0" encoding="UTF-8"?>
<s:Envelope
  xmlns:s="http://www.w3.org/2003/05/soap-envelope"
  xmlns:a="http://www.w3.org/2005/08/addressing">
  <s:Header>
```

```

12480     <a:Action s:mustUnderstand="1">urn:ihe:rad:2009:RetrieveImagingDocumentSet </a:Action>
12485     <a:MessageID>urn:uuid:0fbfdced-6c01-4d09-a110-2201afedaa02</a:MessageID>
12485     <a:ReplyTo s:mustUnderstand="1">
12485       <a:Address>http://www.w3.org/2005/08/addressing/anonymous</a:Address>
12485     </a:ReplyTo>
12485     <a:To >http://localhost:2647/XdsService/IHEXDSIDocSource.svc</a:To>
12490   </s:Header>
12490   <s:Body>
12490     <iherad:RetrieveImagingDocumentSetRequest xmlns:iherad="urn:ihe:rad:xdsi-b:2009"
12490       xmlns:ihe="urn:ihe:iti:xds-b:2007">
12490       <iherad:StudyRequest studyInstanceUID="1.3.6.1.4...101">
12495         <iherad:SeriesRequest seriesInstanceUID="1.3.6.1.4...201">
12495           <ihe:DocumentRequest>
12495             <ihe:RepositoryUniqueId>1.3.6.1.4...1000</ihe:RepositoryUniqueId>
12495             <ihe:DocumentUniqueId>1.3.6.1.4...2300</ihe:DocumentUniqueId>
12500           </ihe:DocumentRequest>
12500           <ihe:DocumentRequest>
12500             <ihe:RepositoryUniqueId>1.3.6.1.4...1000</ihe:RepositoryUniqueId>
12500             <ihe:DocumentUniqueId>1.3.6.1.4...2301</ihe:DocumentUniqueId>
12500           </ihe:DocumentRequest>
12500         </iherad:SeriesRequest>
12500       </iherad:StudyRequest>
12500       <iherad:TransferSyntaxUIDList>
12505         <iherad:TransferSyntaxUID> 1.2.840.10008.1.2.1</iherad:TransferSyntaxUID>
12505         <iherad:TransferSyntaxUID> 1.2.840.10008.1.2.4.57</iherad:TransferSyntaxUID>
12505         <iherad:TransferSyntaxUID> 1.2.840.10008.1.2.4.70</iherad:TransferSyntaxUID>
12510       </iherad:TransferSyntaxUIDList>
12510     </iherad:RetrieveImagingDocumentSetRequest>
12510   </s:Body>
12510 </s:Envelope>

```

#### 4.69.5.1.1.2 Asynchronous Web Services Exchange

```

12515 <?xml version="1.0" encoding="UTF-8"?>
12515 <s:Envelope xmlns:s="http://www.w3.org/2003/05/soap-envelope"
12515   xmlns:a="http://www.w3.org/2005/08/addressing">
12520   <s:Header>
12520     <a:Action s:mustUnderstand="1">urn:ihe:rad:2009:RetrieveImagingDocumentSet</a:Action>
12520     <a:MessageID>urn:uuid:0fbfdced-6c01-4d09-a110-2201afedaa02</a:MessageID>
12520     <a:ReplyTo s:mustUnderstand="1">
12520       <a:Address>http://192.168.2.4:9080/XcaService/ImagingDocumentConsumer.svc</a:Address>
12525     </a:ReplyTo>
12525     <a:To >http://localhost:2647/XdsService/IHEXDSIDocSource.svc</a:To>
12525   </s:Header>
12525   <s:Body>
12530     <iherad:RetrieveImagingDocumentSetRequest xmlns:iherad="urn:ihe:rad:xdsi-b:2009"
12530       xmlns:ihe="urn:ihe:iti:xds-b:2007">
12530       <iherad:StudyRequest studyInstanceUID="1.3.6.1.4...101">
12530         <iherad:SeriesRequest seriesInstanceUID="1.3.6.1.4...201">
12535           <ihe:DocumentRequest>
12535             <ihe:RepositoryUniqueId>1.3.6.1.4...1000</ihe:RepositoryUniqueId>
12535             <ihe:DocumentUniqueId>1.3.6.1.4...2300</ihe:DocumentUniqueId>
12540           </ihe:DocumentRequest>
12540           <ihe:DocumentRequest>
12540             <ihe:RepositoryUniqueId>1.3.6.1.4...1000</ihe:RepositoryUniqueId>
12540             <ihe:DocumentUniqueId>1.3.6.1.4...2301</ihe:DocumentUniqueId>
12545           </ihe:DocumentRequest>
12545         </iherad:SeriesRequest>
12545       </iherad:StudyRequest>
12545       <iherad:TransferSyntaxUIDList>
12545         <iherad:TransferSyntaxUID>1.2.840.10008.1.2.1</iherad:TransferSyntaxUID>
12545         <iherad:TransferSyntaxUID>1.2.840.10008.1.2.4.57</iherad:TransferSyntaxUID>
12545         <iherad:TransferSyntaxUID>1.2.840.10008.1.2.4.70</iherad:TransferSyntaxUID>
12545       </iherad:TransferSyntaxUIDList>
12545     </iherad:RetrieveImagingDocumentSetRequest>

```

```

</s:Body>
</s:Envelope>

```

#### 4.69.5.1.2 Sample Retrieve Document Set SOAP Response

##### 4.69.5.1.2.1 Synchronous Web Services Exchange

12550

```
<?xml version="1.0" encoding="UTF-8"?>
```

12555

```

<s:Envelope
  xmlns:s="http://www.w3.org/2003/05/soap-envelope"
  xmlns:a="http://www.w3.org/2005/08/addressing">
  <s:Header>
    <a:Action s:mustUnderstand="1">urn:ihe:iti:2007:RetrieveDocumentSetResponse</a:Action>
    <a:RelatesTo>urn:uuid:0fbfdced-6c01-4d09-a110-2201afedaa02</a:RelatesTo>
  </s:Header>
  <s:Body>

```

12560

```

    <ihe:RetrieveDocumentSetResponse xmlns:ihe="urn:ihe:iti:xds-b:2007"
      xmlns:rs="urn:oasis:names:tc:ebxml-regrep:xsd:rs:3.0">
      <rs:RegistryResponse status="urn:oasis:names:tc:ebxml-regrep:ResponseStatusType:Success"/>
      <ihe:DocumentResponse>

```

12565

```

        <ihe:RepositoryUniqueId>1.3.6.1.4...1000</ihe:RepositoryUniqueId>
        <ihe:DocumentUniqueId>1.3.6.1.4...2300</ihe:DocumentUniqueId>
        <ihe:mimeType>application/dicom</ihe:mimeType>
        <ihe:Document>UjBsR09EbGhjZ0dTQUxNQUFBUUNBRU1tQ1p0dGUXhEUzhi</ihe:Document>
      </ihe:DocumentResponse>

```

12570

```

      <ihe:DocumentResponse>
        <ihe:RepositoryUniqueId>1.3.6.1.4...1000</ihe:RepositoryUniqueId>
        <ihe:DocumentUniqueId>1.3.6.1.4...2301</ihe:DocumentUniqueId>
        <ihe:mimeType>application/dicom</ihe:mimeType>
        <ihe:Document>UjBsR09EbGhjZ0dTQUxNQUFBUUNBRU1tQ1p0dU1GUCx4hu</ihe:Document>
      </ihe:DocumentResponse>

```

12575

```

    </ihe:RetrieveDocumentSetResponse>
  </s:Body>
</s:Envelope>

```

##### 4.69.5.1.2.2 Asynchronous Web Services Exchange

12580

```
<?xml version="1.0" encoding="UTF-8"?>
```

12585

```

<s:Envelope
  xmlns:s="http://www.w3.org/2003/05/soap-envelope"
  xmlns:a="http://www.w3.org/2005/08/addressing">
  <s:Header>
    <a:Action s:mustUnderstand="1">urn:ihe:iti:2007:RetrieveDocumentSetResponse</a:Action>
    <a:MessageID>urn:uuid:D6C21225-8E7B-454E-9750-821622C099DB</a:MessageID>
    <a:RelatesTo>urn:uuid:0fbfdced-6c01-4d09-a110-2201afedaa02</a:RelatesTo>
    <a:To
  s:mustUnderstand="1">http://localhost:2647/XdsService/DocumentConsumerReceiver.svc</a:To>
  </s:Header>
  <s:Body>

```

12590

```

    <ihe:RetrieveDocumentSetResponse xmlns:ihe="urn:ihe:iti:xds-b:2007"
      xmlns:rs="urn:oasis:names:tc:ebxml-regrep:xsd:rs:3.0">
      <rs:RegistryResponse status="urn:oasis:names:tc:ebxml-regrep:ResponseStatusType:Success"/>
      <ihe:DocumentResponse>

```

12595

```

        <ihe:RepositoryUniqueId>1.3.6.1.4...1000</ihe:RepositoryUniqueId>
        <ihe:DocumentUniqueId>1.3.6.1.4...2300</ihe:DocumentUniqueId>
        <ihe:mimeType>application/dicom</ihe:mimeType>
        <ihe:Document>UjBsR09EbGhjZ0dTQUxNQUFBUUNBRU1tQ1p0dGUXhEUzhi</ihe:Document>
      </ihe:DocumentResponse>

```

12600

```

      <ihe:DocumentResponse>
        <ihe:RepositoryUniqueId>1.3.6.1.4...1000</ihe:RepositoryUniqueId>
        <ihe:DocumentUniqueId>1.3.6.1.4...2301</ihe:DocumentUniqueId>
        <ihe:mimeType>application/dicom</ihe:mimeType>
        <ihe:Document>UjBsR09EbGhjZ0dTQUxNQUFBUUNBRU1tQ1p0dU1GUCx4hu</ihe:Document>
      </ihe:DocumentResponse>

```

12605

```

    </ihe:RetrieveDocumentSetResponse>
  </s:Body>
</s:Envelope>

```

</s:Body>  
</s:Envelope>

#### **4.70 Image Manager Instances Stored [RAD-70]**

12610 This transaction is currently in the [Multiple Image Manager/Archive \(MIMA\)](#) Trial Implementation Supplement.

#### **4.71 Image Manager Storage Commitment [RAD-71]**

This transaction is currently in the [Multiple Image Manager/Archive \(MIMA\)](#) Trial Implementation Supplement.

#### **4.72 Image Manager Instances Query [RAD-72]**

12615 This transaction is currently in the [Multiple Image Manager/Archive \(MIMA\)](#) Trial Implementation Supplement.

#### **4.73 Image Manager Instances Retrieval [RAD-73]**

12620 This transaction is currently in the [Multiple Image Manager/Archive \(MIMA\)](#) Trial Implementation Supplement.

#### **4.74 Replacement Instances Stored [RAD-74]**

##### **4.74.1 Scope**

12625 In the Replacement Instances Stored transaction, the Change Requester sends to the Image Manager/Archive new instances (images, presentation states, key image notes, etc.) that represent versions of existing instances that have been corrected in some way (e.g., corrected demographics, view information, or updated annotations).

Acquisition of additional SOP Instances, such as if correction of a Modality Worklist Selection requires additional SOP Instances to be acquired, is out of scope of this transaction, as this is covered by the Scheduled Workflow Profile.

##### **4.74.2 Actor Roles**

**Actor:** Change Requester

**Role:** Transmit updated instances to Image Manager/Archive.

**Actor:** Image Manager/Archive

**Role:** Accept updated instances from Change Requester.

##### **4.74.3 Referenced Standard**

12635 DICOM [PS3.4 Annex B](#): Storage Service Class.

#### 4.74.4 Messages

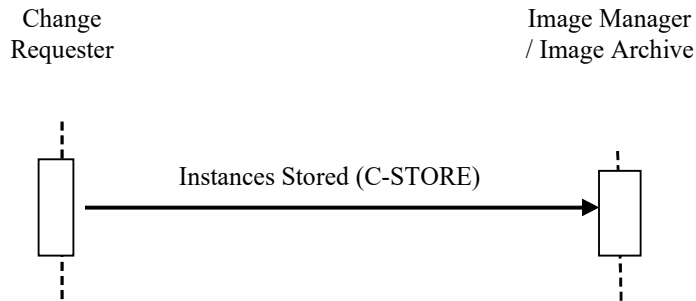


Figure 4.74.4-1: Interaction Diagram

12640 **4.74.4.1 Instances Stored**

##### 4.74.4.1.1 Trigger Events

The Change Requester has created new replacement instances and needs to send them to the Image Manager/Archive.

##### 4.74.4.1.2 Message Semantics

12645 The Change Requester uses the DICOM C-STORE message to transfer the new instances. The Change Requester is the DICOM Storage SCU and the Image Manager/Archive is the DICOM Storage SCP.

A replacement instance created by the Change Requester shall:

- Have the same SOP Class as the replaced instance
  - Belong to a new series
  - Set the header information according to the correct modality worklist entry if correction is the result of new modality worklist selection (see Section 4.74.4.1.2.1)
  - Update the Critical Attributes as described in Table 4.74.4.1.2-1
- 12650

**Table 4.74.4.1.2-1: Critical Attributes for Replacement Instances**

DICOM Attribute	DICOM Tag	Type	Description
Study Instance UID	(0020,000D)	R	Use Study Instance UID of the target study [IHE-1]
Series Instance UID	(0020,000E)	R	Generate new UID [IHE-2]
SOP Instance UID	(0008,0018)	R	Generate new UID [IHE-3]
Contributing Equipment Sequence	(0018,A001)	RC	Identification of the equipment that creates the replacement instances Required if the Change Requester is not the same as the original creator of the replaced instances.



DICOM Attribute	DICOM Tag	Type	Description
> Purpose of Referenced Code Sequence	(0040,A170)	R	Describes the purpose for which the related equipment is being referenced. Use an appropriate code from Table 4.74.4.1.2-2
> Manufacturer	(0008,0070)	R	Manufacturer of the Change Requester
> Institution Name	(0008,0080)	R+	Institution where the Change Requester locates
> Station Name	(0008,1010)	R+	AE Title of the Change Requester
> Contribution DateTime	(0018,A002)	R+	The creation date and time of the replacement instances

12655 IHE-1: The new instances shall be associated with the study that they are targeted for. Therefore, if the new instance replaces an existing instance within the same study, then the Study Instance UID shall remain the same. On the other hand, if the new instance is created due to correction of the modality worklist entry, then the Study Instance UID shall be the Study Instance UID associated with the correct modality worklist entry.

12660 IHE-2: New Series Instance UID means that the newly created instance will not reuse any existing Series Instance UID. According to DICOM, an existing series can only be expanded with new objects if the new objects are created by the same equipment while the procedure step is still in progress. This is not the case for IOCM. As a result, a new series is required for the replacement instances.

IHE-3: New SOP Instance UID means that the instance is a new instance, not the same existing instance with updated header information. See Section 4.74.4.1.2.1 for details about replacement of SOP Instance UID.

12665 **Table 4.74.4.1.2-2: Codes for Contributing Equipment**

Code Value	Code Scheme Designator	Code Meaning
DCM	109103	Modifying Equipment

A Change Requester grouped with an Acquisition Modality shall also support the semantics defined in Modality Images Stored [RAD-8] and Modality Presentation State Stored [RAD-9].

A Change Requester grouped with an Evidence Creator shall also support the semantics defined in the Creator Images Stored [RAD-18] and Creator Presentation State Stored [RAD-19].

12670 A Change Requester grouped with an Image Manager/Archive that supports the Scheduled Workflow Multiple Identity Resolution Option, shall also support the semantics defined in Image Manager Instances Stored [RAD-70].

#### 4.74.4.1.2.1 Correction of Scheduled Procedure Information

12675 Correction of scheduled procedure information in the corrected instances will be based on information from the modality worklist entry when the Change Requester is an Acquisition Modality. When a Change Requester is an Image Manager/Archive, it can get the same information from the Procedure Scheduled [RAD-4] transaction. The following text will refer only to the modality worklist case. The use of [RAD-4] information should be understood. Note that when using Table 4.74.4.1.2.1-1 and Tables defined in RAD TF-2x: Appendix A.1, the Modality Worklist column refers to the correct Modality Worklist item, and the Image/Standalone IOD and MPPS IOD columns are for the replacement SOP Instances and their corresponding MPPS.

12680

During correction of scheduled procedure information, the Change Requester shall create new instances from the originally acquired instances which replace these original instances.

12685 Two alternative scenarios can follow, depending upon whether or not the acquired images are relevant to the actual scheduled procedure for the correct patient. Regardless, of which scenario occurs, if additional images need to be acquired for the actual scheduled procedure for the correct patient then this shall be done according to Scheduled Workflow.

12690 If it is determined that the originally acquired images are relevant to the actual scheduled procedure for the correct patient, or if a new scheduled procedure has been created on the DSS/OF for these images, then the patient and procedure attribute values can be taken from this scheduled information. The required mapping of attributes shall be as defined in RAD TF-2x: Appendix A.1, unless the mapping rules are overridden by the attribute mapping defined in in Table 4.74.4.1.2.1-1.

12695 **Table 4.74.4.1.2.1-1: Critical Attributes Mapping Exception**

DICOM attribute	Modality Worklist	Filling values for: ↓	
	(return attribute values)	Image/ Standalone IOD	MPPS IOD
<b>Performed Protocol Code Sequence</b> (0040,0260)	n.a.	Copy from the Original Instance or Original MPPS. The Performed Procedure Step for a corrected SOP Instance will still be that of the originally selected Modality Worklist item (and thus may not correspond to the correct one).	Copy from the Original Instance or Original MPPS. The Performed Procedure Step for a corrected SOP Instance will still be that of the originally selected Modality Worklist item (and thus may not correspond to the correct one).
<b>Performed Procedure Step ID</b> (0040,0253)	n.a.	Copy from the Original Instance or Original MPPS.	
<b>Performed Procedure Step Start Date</b> (0040,0244)	n.a.	Copy from the Original Instance or Original MPPS.	Copy from the Original Instance or Original MPPS.
<b>Performed Procedure Step Start Time</b> (0040,0245)	n.a.	Copy from the Original Instance or Original MPPS.	Copy from the Original Instance or Original MPPS.
<b>Performed Procedure Step Description</b> (0040,0254)	n.a.	Copy from the Original Instance or Original MPPS.	Copy from the Original Instance or Original MPPS.
<b>Protocol Name</b> (0018,1030)	n.a.	Copy from the Original Instance or Original MPPS.	<b>Performed Series Sequence</b> (0040,0340) Copy from the Original Instance or Original MPPS.

Alternatively, if the originally acquired images are not relevant to the actual scheduled procedure for the correct patient, and no new scheduled procedure has been created on the DSS/OF for these images, then the images could be manually corrected as for an unscheduled exam.

#### 4.74.4.1.2.2 Maintenance of Instance Referential Integrity

- 12700 Since SOP Instance UIDs are sometimes used as references in other related instances (e.g., Referenced Images Sequence in GSPS objects), the Change Requester shall ensure the consistency of SOP Instance references for all instances that it is aware of (e.g., possesses) and for SOP Classes for which it claims support in this respect in its DICOM Conformance Statement, irrespective of the source of the instances, and irrespective of whether or not the
- 12705 Change Requester is grouped with an Acquisition Modality, Evidence Creator or Image Manager/Archive. For example, if the Change Requester replaces the original object Image1 (SOP Instance UID 1.2.3) by replacement object Image2 (SOP Instance UID 1.2.3.1), then the Change Requester shall also correct existing GSPS object GSPS1 that has a reference to Image1 by replacing it with a new GSPS object GSPS2 that has the corrected reference to Image2.
- 12710 A Change Requester may not have sufficient understanding of the structure of the underlying references in the IOD to maintain referential integrity. At minimum, a Change Requester shall be capable of correcting SOP Instance UID references within Images, Presentation States, Key Image Notes and Structured Reports. The Change Requester is not required to maintain the referential integrity of references within Private Attributes.
- 12715 A Change Requester shall not replace SOP Instance UID references in the Rejection Note itself and shall not replace the SOP Instance UIDs of the instances that are being rejected.
- As an example, if the Change Requester maintains a map of rejected SOP Instance UIDs to replacement UIDs, if any, the Change Requester may replace all references in all instances to rejected UIDs with replacement UIDs to maintain referential integrity without needing to
- 12720 inherently understand the entire structure of the IOD for a SOP Class and irrespective of whether the instance is known at the time of the change request being received or subsequently.
- The receiving Image Manager/Archive is not required to correct the content of other instances it has stored in order to maintain the referential integrity within a study based on receipt of a Rejection Note or replacement instances, though it is not prohibited from attempting to do so. If
- 12725 the Image Manager/Archive receives instances for the same study from sources other than those grouped with the Change Requester, then it is possible that the references to some instances may be incorrect (e.g., When GSPS instances are not rejected in the Rejection Note but received from an Evidence Creator not grouped with the Change Requester, such GSPS instances may reference rejected image instances and the Image Manager Archive has no means of determining
- 12730 what the UIDs of the replacement instances are, if any).
- Note: A receiving Image Manager/Archive should be wary of removing an instance that references rejected instances, since the other content of the referring instance may still be useful. E.g., the referring instance might be a report with measurements that need to be retained, even though it contains references to rejected images. It may be appropriate to raise an exception and
- 12735 require human intervention in such cases.

#### 4.74.4.1.3 Expected Actions

The Image Manager/Archive shall store the received DICOM objects such that they can be later retrieved (see Retrieve Images [RAD-16]) in a fashion meeting the requirements defined for a DICOM Level 2 Storage SCP (Refer to DICOM [PS3.4 Section B.4.1](#)).

### 12740 4.75 Cross Gateway Retrieve Imaging Document Set [RAD-75]

#### 4.75.1 Scope

This transaction is used to retrieve DICOM instances from a remote community.

#### 4.75.2 Actor Roles

**Actor:** Initiating Imaging Gateway

12745 **Role:** requests DICOM instances from a remote community.

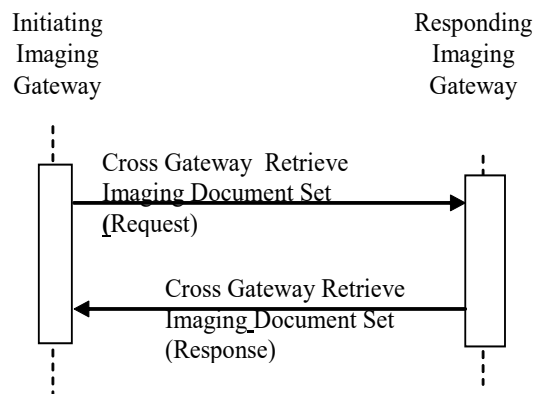
**Actor:** Responding Imaging Gateway

**Role:** returns the requested DICOM instances.

#### 4.75.3 Referenced Standard

12750 For a list of the standards inherited from the underlying Retrieve Document Set [ITI-43] transaction; see [ITI TF-2: 3.43.3](#).

#### 4.75.4 Messages



**Figure 4.75.4-1: Interaction Diagram**

#### 4.75.4.1 Cross Gateway Retrieve Imaging Document Set

12755 The Cross Gateway Retrieve Imaging Document Set uses the same syntax and standards as the Retrieve Imaging Document Set transaction specified in [RAD-69]. See Section 4.69.

#### 4.75.4.1.1 Trigger Events

12760 This message is initiated by the Initiating Imaging Gateway to retrieve Imaging Document Set(s) from another community represented by a Responding Imaging Gateway. The triggers for the Initiating Imaging Gateway include:

- a Retrieve Imaging Document Set [RAD-69] request initiated by an Imaging Document Consumer within the Initiating Imaging Gateway's community.
- Prefetch logic as a result of a retrieval of a DICOM manifest

#### 4.75.4.1.2 Message Semantics

12765 The message semantics for Cross Gateway Retrieve Imaging Document Set are the same as Retrieve Imaging Document Set [RAD-69] Request Message. See Section 4.69.4.1.2.

#### 4.75.4.1.3 Expected Actions

12770 The Responding Imaging Gateway shall determine the Imaging Document Source(s) which hold the DICOM instances requested and initiate a [RAD-69] transaction to those Imaging Document Sources.

If more than one Imaging Document Source is contacted, the Responding Imaging Gateway shall consolidate the results from the multiple sources into one response to the Initiating Imaging Gateway. If both successes and failures are received, the Responding Imaging Gateway may choose to use PartialSuccess status to reflect both failure and success. The Responding Imaging Gateway may alternatively choose to suppress the failures and report only successes.

12775 Every RegistryError element returned in the response shall have the location attribute set to the homeCommunityId of the Responding Imaging Gateway.

The Responding Imaging Gateway shall return consolidated responses according to message semantics for the Retrieve Imaging Document Set Response message in Section 4.69.4.2.2.

#### 12780 4.75.4.2 Asynchronous Web Service Method

An Initiating Imaging Gateway that supports the Asynchronous Web Services Option shall use the Asynchronous Web Services Exchange method.

The Responding Imaging Gateway shall respond to an Initiating Imaging Gateway using the Asynchronous Web Service Method.

12785 The Initiating Imaging Gateway supporting this method shall use the non-anonymous response EPR in the WS-Addressing replyTo header.

The Initiating and Responding Imaging Gateways shall support the Asynchronous Web Services Methods in the [ITI TF-2: Appendix V.5](#): Web Services for IHE Transactions, which also includes additional considerations for implementers.

12790 **4.75.5 Protocol Requirements**

The Cross Gateway Retrieve Imaging Document Set request and response protocol requirements are identical to the Retrieve Imaging Document Set Transaction except as noted below.

**Table 4.75.5-1: WSDL Namespace Definitions**

Soap	<a href="http://schemas.xmlsoap.org/wsdl/soap/">http://schemas.xmlsoap.org/wsdl/soap/</a>
soap12	<a href="http://schemas.xmlsoap.org/wsdl/soap12/">http://schemas.xmlsoap.org/wsdl/soap12/</a>
Wsaw	<a href="http://www.w3.org/2006/05/addressing/wsdl/">http://www.w3.org/2006/05/addressing/wsdl/</a>
Xsd	<a href="http://www.w3.org/2001/XMLSchema">http://www.w3.org/2001/XMLSchema</a>
Iherad	urn:ihe:rad:xdsi-b:2009
Ihe	urn:ihe:iti:xds-b:2007
Rs	urn:oasis:names:tc:ebxml-regrep:xsd:rs:3.0
Lcm	urn:oasis:names:tc:ebxml-regrep:xsd:lcm:3.0
Query	urn:oasis:names:tc:ebxml-regrep:xsd:query:3.0

12795 **Responding Imaging Gateway:** These are the requirements for the Cross Gateway Retrieve Imaging Document Set transaction presented in the order in which they would appear in the Responding Imaging Gateway WSDL definition:

- The following types shall be imported (xsd:import) in the /definitions/types section:
  - namespace="urn:ihe:rad:xdsi-b:2009",

12800 schema="XDSI.b\_ImagingDocumentSource.xsd"  
 The baseline XDS.b schema (namespace="urn:ihe:iti:xds-b:2007",  
 schema="XDS.b\_DocumentRepository.xsd")

- The /definitions/message/part/@element attribute of the Cross Gateway Retrieve Imaging Document Set Request message shall be defined as  
 12805 "iherad:RetrieveImagingDocumentSetRequest"

- The /definitions/message/part/@element attribute of the Cross Gateway Retrieve Imaging Document Set Response message shall be defined as  
 "urn:ihe:iti:2007:RetrieveDocumentSetResponse"

Attributes shall be set as described below Table 4.75.5-2.

12810 To support Asynchronous Web Services Exchange on the Imaging Document Consumer or the Responding Imaging Gateway, the Imaging Document Source or the Initiating Imaging Gateway shall support the use of a non-anonymous response EPR in the WS-Addressing replyTo header.

**Table 4.75.5-2: Requirements for portType and Binding attributes**

Attribute	Web Service Exchange
/definitions/portType/operation@name	RespondingGateway_CrossGatewayRetrieveImagingDocumentSet

Attribute	Web Service Exchange
/definitions/portType/operation/input/@wsaw:Action	urn:ihe:rad:2011:CrossGatewayRetrieveImagingDocumentSet
/definitions/portType/operation/output/@wsaw:Action	urn:ihe:rad:2011:CrossGatewayRetrieveImagingDocumentSetResponse
/definitions/binding/operation/soap12:operation/@soapAction	urn:ihe:rad:2011:CrossGatewayRetrieveImagingDocumentSet

12815 These are the requirements that affect the wire format of the SOAP message. The other WSDL properties are only used within the WSDL definition and do not affect interoperability. Full sample request and response messages are in Section 4.75.5.1 Sample SOAP Messages.

For informative WSDL for the Responding Gateway see [ITI TF-2: Appendix W](#).

12820 The <iherad:RetrieveImagingDocumentSetRequest/> element is defined in Section 4.69.5. When used within the Cross Gateway Retrieve Imaging Document Set the <ihe:HomeCommunityId/> element is required.

A full XML Schema Document, the WSDL and sample messages for the XCA-I types, are available in the IHE Google Drive under [IHE Documents > TF Implementation Material > Rad](#).

#### 4.75.5.1 Sample SOAP Messages

12825 The samples in the following two sections show a typical SOAP request and its relative SOAP response. The sample messages also show the WS-Addressing headers <Action/>, <MessageID/>, <ReplyTo/>...; these WS-Addressing headers are populated according to the W3C WS-Addressing standard. The body of the SOAP message is omitted for brevity; in a real scenario the empty element will be populated with the appropriate metadata.

12830 Samples presented in this section are also available in the IHE Google Drive under [IHE Documents > TF Implementation Material > Rad](#).

#### 4.75.5.1.1 Sample Cross Gateway Retrieve Imaging Document Set SOAP Request

##### 4.75.5.1.1.1 Synchronous Web Services Exchange

```

12835 <?xml version="1.0" encoding="UTF-8"?>
      <s:Envelope
        xmlns:s="http://www.w3.org/2003/05/soap-envelope"
        xmlns:a="http://www.w3.org/2005/08/addressing">
12840   <s:Header>
        <a:Action
          s:mustUnderstand="1">urn:ihe:rad:2011:CrossGatewayRetrieveImagingDocumentSet</a:Action>
        <a:MessageID>urn:uuid:0fbfdced-6c01-4d09-a110-2201afedaa02</a:MessageID>
        <a:ReplyTo>
          <a:Address>http://www.w3.org/2005/08/addressing/anonymous</a:Address>
12845 </a:ReplyTo>
        <a:To s:mustUnderstand="1" >http://localhost:2647/XcaService/IHEXCAIGateway.svc</a:To>
      </s:Header>
      <s:Body>
12850   <iherad:RetrieveImagingDocumentSetRequest xmlns:iherad="urn:ihe:rad:xdsi-b:2009"
        xmlns:ihe="urn:ihe:iti:xds-b:2007">

```

```

12855 <iherad:StudyRequest studyInstanceUID="1.3.6.1.4...101">
      <iherad:SeriesRequest seriesInstanceUID="1.3.6.1.4...201">
        <ihe:DocumentRequest>
          <ihe:HomeCommunityId>urn:oid:1.2.3.4</ihe:HomeCommunityId>
12860         <ihe:RepositoryUniqueId>1.3.6.1.4...1000</ihe:RepositoryUniqueId>
          <ihe:DocumentUniqueId>1.3.6.1.4...2300</ihe:DocumentUniqueId>
        </ihe:DocumentRequest>
        <ihe:DocumentRequest>
          <ihe:HomeCommunityId>urn:oid:1.2.3.4</ihe:HomeCommunityId>
12865         <ihe:RepositoryUniqueId>1.3.6.1.4...1000</ihe:RepositoryUniqueId>
          <ihe:DocumentUniqueId>1.3.6.1.4...2301</ihe:DocumentUniqueId>
        </ihe:DocumentRequest>
      </iherad:SeriesRequest>
    </iherad:StudyRequest>
12870 <iherad:TransferSyntaxUIDList>
      <iherad:TransferSyntaxUID> 1.2.840.10008.1.2.1</iherad:TransferSyntaxUID>
      <iherad:TransferSyntaxUID> 1.2.840.10008.1.2.4.57</iherad:TransferSyntaxUID>
      <iherad:TransferSyntaxUID> 1.2.840.10008.1.2.4.70</iherad:TransferSyntaxUID>
    </iherad:TransferSyntaxUIDList>
  </iherad:RetrieveImagingDocumentSetRequest>
</s:Body>
</s:Envelope>

```

#### 4.75.5.1.1.2 Asynchronous Web Services Exchange

```

12875 <?xml version="1.0" encoding="UTF-8"?>
<s:Envelope
  xmlns:s="http://www.w3.org/2003/05/soap-envelope"
  xmlns:a="http://www.w3.org/2005/08/addressing">
12880   <s:Header>
     <a:Action s:mustUnderstand="1">urn:ihe:rad:2011:CrossGatewayRetrieveImagingDocumentSet
  </a:Action>
     <a:MessageID>urn:uuid:0fbfdced-6c01-4d09-a110-2201afedaa02</a:MessageID>
     <a:ReplyTo>
12885       http://192.168.2.4:9080/XcaiService/InitiatingImagingGatewayReceiver.svc
     </a:ReplyTo>
     <a:To s:mustUnderstand="1">http://localhost:2647/XcaiService/IHEXCAIGateway.svc</a:To>
   </s:Header>
  <s:Body>
12890   <iherad:RetrieveImagingDocumentSetRequest xmlns:iherad="urn:ihe:rad:xdsi-b:2009"
     xmlns:ihe="urn:ihe:iti:xds-b:2007">
     <iherad:StudyRequest studyInstanceUID="1.3.6.1.4...101">
       <iherad:SeriesRequest seriesInstanceUID="1.3.6.1.4...201">
         <ihe:DocumentRequest>
12895         <ihe:HomeCommunityId>urn:oid:1.2.3.4</ihe:HomeCommunityId>
           <ihe:RepositoryUniqueId>1.3.6.1.4...1000</ihe:RepositoryUniqueId>
           <ihe:DocumentUniqueId>1.3.6.1.4...2300</ihe:DocumentUniqueId>
         </ihe:DocumentRequest>
         <ihe:DocumentRequest>
12900         <ihe:HomeCommunityId>urn:oid:1.2.3.4</ihe:HomeCommunityId>
           <ihe:RepositoryUniqueId>1.3.6.1.4...1000</ihe:RepositoryUniqueId>
           <ihe:DocumentUniqueId>1.3.6.1.4...2301</ihe:DocumentUniqueId>
         </ihe:DocumentRequest>
       </iherad:SeriesRequest>
     </iherad:StudyRequest>
12905   <iherad:TransferSyntaxUIDList>
     <iherad:TransferSyntaxUID> 1.2.840.10008.1.2.1</iherad:TransferSyntaxUID>
     <iherad:TransferSyntaxUID> 1.2.840.10008.1.2.4.57</iherad:TransferSyntaxUID>
     <iherad:TransferSyntaxUID> 1.2.840.10008.1.2.4.70</iherad:TransferSyntaxUID>
   </iherad:TransferSyntaxUIDList>
12910   </iherad:RetrieveImagingDocumentSetRequest>
</s:Body>
</s:Envelope>

```



### 4.75.5.1.2 Sample Cross Gateway Retrieve Imaging Document Set SOAP Response

12915

#### 4.75.5.1.2.1 Synchronous Web Services Exchange

12920

```

<?xml version="1.0" encoding="UTF-8"?>
<s:Envelope xmlns:s="http://www.w3.org/2003/05/soap-envelope"
  xmlns:a="http://www.w3.org/2005/08/addressing">
  <s:Header>
    <a:Action
s:mustUnderstand="1">urn:ihe:rad:2011:CrossGatewayRetrieveImagingDocumentSetResponse</a:Action>
    <a:RelatesTo>urn:uuid:0fbfdced-6c01-4d09-a110-2201afedaa02</a:RelatesTo>
  </s:Header>
  <s:Body>
    <ihe:RetrieveDocumentSetResponse xmlns:ihe="urn:ihe:iti:xds-b:2007"
      xmlns:rs="urn:oasis:names:tc:ebxml-regrep:xsd:rs:3.0">
      <rs:RegistryResponse status="urn:oasis:names:tc:ebxml-regrep:ResponseStatusType:Success"/>
      <ihe:DocumentResponse>
        <ihe:HomeCommunityId>urn:oid:1.2.3.4</ihe:HomeCommunityId>
        <ihe:RepositoryUniqueId>1.3.6.1.4...1000</ihe:RepositoryUniqueId>
        <ihe:DocumentUniqueId>1.3.6.1.4...2300</ihe:DocumentUniqueId>
        <ihe:mimeType>application/dicom</ihe:mimeType>
        <ihe:Document>UjBsR09EbGhjZ0dTQUxNQUFBUNBRU1tQ1p0dGUXhEUzhi</ihe:Document>
      </ihe:DocumentResponse>
      <ihe:DocumentResponse>
        <ihe:HomeCommunityId>urn:oid:1.2.3.4</ihe:HomeCommunityId>
        <ihe:RepositoryUniqueId>1.3.6.1.4...1000</ihe:RepositoryUniqueId>
        <ihe:DocumentUniqueId>1.3.6.1.4...2301</ihe:DocumentUniqueId>
        <ihe:mimeType>application/dicom</ihe:mimeType>
        <ihe:Document>UjBsR09EbGhjZ0dTQUxNQUFBUNBRU1tQ1p0dU1GUCx4hu</ihe:Document>
      </ihe:DocumentResponse>
    </ihe:RetrieveDocumentSetResponse>
  </s:Body>
</s:Envelope>

```

12925

12930

12935

12940

12945

#### 4.75.5.1.2.2 Asynchronous Web Services Exchange

12950

```

<?xml version="1.0" encoding="UTF-8"?>
<s:Envelope
  xmlns:s="http://www.w3.org/2003/05/soap-envelope"
  xmlns:a="http://www.w3.org/2005/08/addressing">
  <s:Header>
    <a:Action
s:mustUnderstand="1">urn:ihe:rad:2011:CrossGatewayRetrieveImagingDocumentSetResponse</a:Action>
    <a:MessageID>urn:uuid:D6C21225-8E7B-454E-9750-821622C099DB</a:MessageID>
    <a:RelatesTo>urn:uuid:0fbfdced-6c01-4d09-a110-2201afedaa02</a:RelatesTo>
    <a:To s:mustUnderstand="1">
12960 http://192.168.2.4:9080/XcaiService/InitiatingImagingGatewayReceiver.svc </a:To>
  </s:Header>
  <s:Body>
    <ihe:RetrieveDocumentSetResponse xmlns:ihe="urn:ihe:iti:xds-b:2007"
      xmlns:rs="urn:oasis:names:tc:ebxml-regrep:xsd:rs:3.0">
      <rs:RegistryResponse status="urn:oasis:names:tc:ebxml-regrep:ResponseStatusType:Success"/>
      <ihe:DocumentResponse>
        <ihe:HomeCommunityId>urn:oid:1.2.3.4</ihe:HomeCommunityId>
        <ihe:RepositoryUniqueId>1.3.6.1.4...1000</ihe:RepositoryUniqueId>
        <ihe:DocumentUniqueId>1.3.6.1.4...2300</ihe:DocumentUniqueId>
        <ihe:mimeType>application/dicom</ihe:mimeType>
        <ihe:Document>UjBsR09EbGhjZ0dTQUxNQUFBUNBRU1tQ1p0dGUXhEUzhi</ihe:Document>
      </ihe:DocumentResponse>
      <ihe:DocumentResponse>
        <ihe:HomeCommunityId>urn:oid:1.2.3.4</ihe:HomeCommunityId>
        <ihe:RepositoryUniqueId>1.3.6.1.4...1000</ihe:RepositoryUniqueId>

```

12955

12960

12965

12970

12975

12980 

```
<ihe:DocumentUniqueId>1.3.6.1.4...2301</ihe:DocumentUniqueId>
<ihe:mimeType>application/dicom</ihe:mimeType>
<ihe:Document>UjBsR09EbGhjZ0dTQUxNQUFBUNBRU1tQ1p0dU1GUCx4hu</ihe:Document>
</ihe:DocumentResponse>
</ihe:RetrieveDocumentSetResponse>
</s:Body>
</s:Envelope>
```

#### 4.76 Query for Studies [RAD-76]

12985 This transaction is currently in the [Import Reconciliation Workflow \(IRWF.b\)](#) Trial Implementation Supplement.

#### 4.77 Query for Patient ID [RAD-77]

This transaction is currently in the [Import Reconciliation Workflow \(IRWF.b\)](#) Trial Implementation Supplement.

#### 4.78 Request Filling of Order [RAD-78]

12990 This transaction is currently in the [Import Reconciliation Workflow \(IRWF.b\)](#) Trial Implementation Supplement.

#### 4.79 Import Instructions Request [RAD-79]

This transaction is currently in the [Import Reconciliation Workflow \(IRWF.b\)](#) Trial Implementation Supplement.

#### 12995 4.80 [RAD-80] – [RAD-102]

These transactions are currently in the [Post-Acquisition Workflow \(PAWF\)](#) Trial Implementation Supplement

#### 4.103 Retrieve Imaging Report Template [RAD-103]

##### 4.103.1 Scope

13000 This transaction is used to retrieve a template from a Report Template Manager in the proper format.

##### 4.103.2 Actor Roles

**Table 4.103.2-1: Actor Roles**

<b>Role:</b>	<b>Requester:</b> Requests a template or templates from the Responder
<b>Actor(s):</b>	The following actor may play the role of Requester: <ul style="list-style-type: none"> <li>• Report Creator</li> </ul>
<b>Role:</b>	<b>Responder:</b> Provides a template or templates in response to the request

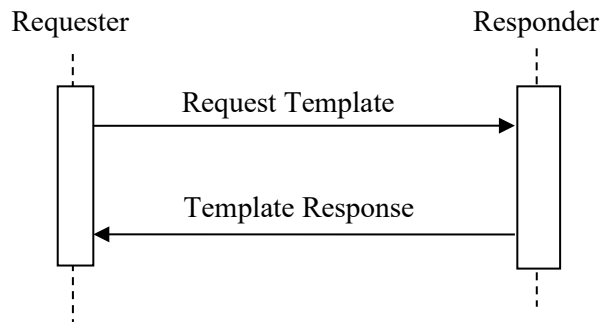
<b>Actor(s):</b>	The following actor may play the role of Responder: <ul style="list-style-type: none"> <li>• Report Template Manager</li> </ul>
------------------	---------------------------------------------------------------------------------------------------------------------------------

13005 Transaction text specifies behavior for each role. The behavior of specific actors may also be specified when it goes beyond that of the general role.

#### 4.103.3 Referenced Standards

- IETF RFC2616 HyperText Transfer Protocol HTTP/1.1
- Extensible Markup Language (XML) 1.0 (Second Edition). W3C Recommendation 6 October 2000. <http://www.w3.org/TR/REC-xml>.
- Dublin Core Metadata Element Set, standardized as ISO Standard 15836: 2009 and ANSI/NISO Standard Z39.85-2012. <http://dublincore.org/documents/dces/>

#### 4.103.4 Messages



13015 **Figure 4.103.4-1: Interaction Diagram**

##### 4.103.4.1 Request Template Message

The Requester sends a message to the Responder indicating the templates it would like to receive.

13020 A Responder shall support handling such messages from more than one Requester. A Requester may choose to support making requests to more than one Responder.

##### 4.103.4.1.1 Trigger Events

- A Requester needs to collect templates for later use in anticipation of reporting in the future.
- The user of a Requester, such as a Report Creator, invokes a template.
- A Requester needs to retrieve a template that has been referenced by another template.

#### 4.103.4.1.2 Message Semantics

The message is an HTTP GET request.

The HTTP request shall include the following parameters to identify the template to be returned. All parameter names and values are case-sensitive.

13030

**Table 4.103.4.1.2-1: HTTP Path Parameters**

Parameter Name	REQ	Description	Values
templateUID	R	Identifies template's UID as known to both actors, expressed by the dterms.identifier element shown in RAD TF-3: Table 8.1.1-1.	This value shall be a properly defined Object identifier (OID) as specified in ITI TF-2x: Appendix B.

The only binding required for both the Requester and Responder is the binding to the HTTP-GET. In this binding the sample message will be formatted as follows:

http://<location>/IHETemplateService/<templateUID>

13035

The <location> part of the URL shall contain the host name, an optional port address, and may be followed by an optional path. The remainder of the URL, including IHETemplateService and the following request parameters shall not be changed. See the discussion about location in [ITI TF-2: 3.11.4.1.2 Message Semantics](#).

13040

If necessary, the Requester may perform the request to the web service utilizing HTTPS protocol. The Responder shall respond using HTTPS if requested.

The Responder may return HTTP redirect responses to a request. The Requester can expect to receive an error response, or the data requested, or a request to look elsewhere for the data. The Requester shall follow redirects, but if a loop is detected, it may report an error.

#### 4.103.4.1.3 Expected Actions

13045

The Responder shall parse the request and create a response containing the templates meeting the parameters of the request in the proper format. If multiple requests are received, each is handled in sequence.

The Responder shall provide a response message header containing the appropriate status code indicating success, warning, or failure as shown in Table 4.103.4.1.3-1.

13050

**Table 4.103.4.1.3-1: HTTP Responses**

Service Status	HTTP1.1 Status Codes	Description
Failure (see Note 2)	503 – Busy	This indicates that the Responder was unable to provide the template because it was out of resources.

Service Status	HTTP1.1 Status Codes	Description
	404 – Not Found	This indicates that the Responder was unable to provide the template because it did not exist on the responder at the time of the request.
	401 — Unauthorized	This indicates that the Responder refused to provide a template because authentication credentials were not provided or not sufficient.
	400 – Bad Request	This indicates that the Responder was unable to provide the template because the template UID is missing or corrupt.
Success	200 – OK	This indicates that the request was successful and the Responder will provide the template.

Note 1: Other HTTP response codes may be returned by the Responder, indicating conditions outside of the scope of this transaction.

Note 2: It is recommended that the Responder complement the returned error code with a human readable description of the error condition.

13055 If an error condition cannot be automatically recovered, at a minimum, the error should be displayed to the user by the Requester.

The Requester may wish to request any templates that are embedded in the response (see RAD TF-3: 8.1.4) immediately, rather than retrieve embedded templates on demand later when the Responder may not be available.

13060 **4.103.4.2 Template Response Message**

The Responder transmits the requested templates to the Requester.

**4.103.4.2.1 Trigger Events**

The Template Response message is created in response to a Responder receiving a Request Template message.

13065 **4.103.4.2.2 Message Semantics**

The message is a document in a HTTP GET response.

**4.103.4.2.3 Expected Actions**

The Responder shall format the document according to content definition in RAD TF-3: 8.1, and return it in the HTTP response. The document shall be processed according to the features, configuration, and business logic of the Requester. Possibilities include making the template accessible to the user.

13070

#### 4.103.5 Security Considerations

13075 Although the content of templates is not typically protected information, for consistency with other transactions on the client, which likely will involve protected information, it is reasonable to expect support for HTTPS.

##### 4.103.5.1 Security Audit Considerations

None

#### 4.104 Store Imaging Report Template [RAD-104]

##### 4.104.1 Scope

13080 This transaction is used to store templates in the proper format on another system.

##### 4.104.2 Actor Roles

**Table 4.104.2-1: Actor Roles**

<b>Role:</b>	<b>Sender:</b> Sends and requests storage of templates
<b>Actor(s):</b>	The following actors may play the role of Sender: <ul style="list-style-type: none"> <li>• Report Template Creator</li> <li>• Report Template Manager</li> </ul>
<b>Role:</b>	<b>Receiver:</b> Receives and stores templates
<b>Actor(s):</b>	The following actor may play the role of Receiver: <ul style="list-style-type: none"> <li>• Report Template Manager</li> </ul>

13085 Transaction text specifies behavior for each role. The behavior of specific actors may also be specified when it goes beyond that of the general role.

##### 4.104.3 Referenced Standards

- IETF RFC2616 HyperText Transfer Protocol HTTP/1.1
- Extensible Markup Language (XML) 1.0 (Second Edition). W3C Recommendation 6 October 2000. <http://www.w3.org/TR/REC-xml>.
- 13090 • Dublin Core Metadata Element Set, standardized as ISO Standard 15836: 2009 and ANSI/NISO Standard Z39.85-2012. <http://dublincore.org/documents/dces/>

#### 4.104.4 Messages

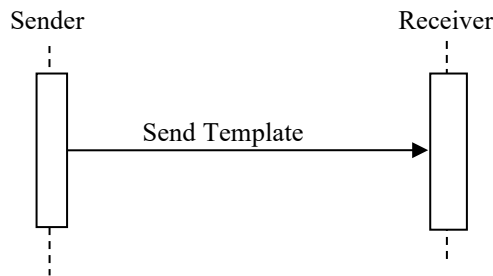


Figure 4.104.4-1: Interaction

#### 13095 4.104.4.1 Send Template Message

The Sender provides the template to a Receiver.

A Receiver shall support handling such messages from more than one Sender. A Sender may choose to support storing templates to more than one Receiver.

##### 4.104.4.1.1 Trigger Events

- 13100 1. A Report Template Manager (acting as a Sender) needs to transmit a template to another Report Template Manager (acting as a Receiver) for storage.
- 2. A Report Template Creator (acting as a Sender) needs to store a template that it has created or updated.

##### 4.104.4.1.2 Message Semantics

13105 The message is an HTTP PUT request. The Sender shall format the document according to content definition in RAD TF-3: 8.1.

The HTTP request shall include the following parameters to identify the template to be stored. All parameter names and values are case-sensitive.

Table 4.104.4.1.2-1: HTTP Path Parameters

Parameter Name	REQ	Description	Values
templateUID	R	Identifies template's UID as known to both actors.	<p>This value shall be a properly defined Object identifier (OID) as specified in <a href="#">ITI TF-2: Appendix B</a>.</p> <p>The value of <b>templateUID</b> shall match the value of the <b>dcterms.identifier</b> attribute in the report template's metadata. See RAD TF-3: Table 8.1.1-1.</p> <p>If the Sender has changed the <b>body</b> element of an existing report template, it shall create a new <b>templateUID</b> for the template.</p>

Parameter Name	REQ	Description	Values
			<p>If the Sender updates elements in the <b>head</b> element of a report template, it is permitted to retain the value of <b>templateUID</b>.</p> <p>Note 1: Replacement of templates is intended to allow the Sender to update metadata (for example changing the status from ACTIVE to RETIRED) but is not intended to permit modification of the template content itself. If the content of the <b>body</b> element of the template was modified, the Sender will have assigned a new value for <b>dcterms.identifier</b>.</p>

13110

The only binding required for both the Sender and Receiver is the binding to the HTTP-PUT. In this binding the sample message will be formatted as follows:

http://<location>/IHETemplateService/<templateUID>

13115

The <location> part of the URL shall contain the host name, an optional port address, and may be followed by an optional path. The remainder of the URL, including IHETemplateService and the following request parameters shall not be changed.

If necessary, the Sender may perform the request to the web service utilizing HTTPS protocol. In this case, the Receiver shall respond using HTTPS.

13120

The Receiver may return HTTP redirect responses to a request. The Sender can expect to receive an error response, or the data requested, or a request to look elsewhere for the data. The Sender shall follow redirects, but if a loop is detected, it may report an error.

#### 4.104.4.1.3 Expected Actions

The Receiver shall accept the request to store the template. If multiple requests are received, each is handled in sequence.

13125

The Receiver shall store all metadata in the **head** element along with the complete contents of the report template contained in the **body** element. See RAD TF-3: 8.1.

- If the **dcterms.identifier** of the template does not already exist on the Receiver, the Receiver shall store the complete contents of the new template.

13130

If the **dcterms.identifier** of the template already exists on the Receiver, the Receiver shall replace the existing template with the received template, including any updated values for the metadata attributes.

The Receiver shall provide a response message header containing the appropriate status code indicating success, warning, or failure as shown in Table 4.104.4.1.3-1.



**Table 4.104.4.1.3-1: HTTP Responses**

Service Status	HTTP1.1 Status Codes	Description
Failure (see Note 2)	503 – Busy	This indicates that the Responder was unable to store the template because it was out of resources.
	422 – Unprocessable Entity	This indicates that the Responder was unable to store the template because the template does not conform to RAD TF-3: 8.1.
	401 – Unauthorized	This indicates that the Responder refused to store the template because authentication credentials were not provided or not sufficient.
	400 – Bad Request	This indicates that the Responder was unable to store the template because the template UID is missing or corrupt or did not match the value of the <code>dcterms.identifier</code> attribute in the report template’s metadata. See RAD TF-3: Table 8.1.1-1.
Success	200 – OK	This indicates that the request was successful and the Responder has stored the template.

13135 Note 1: Other HTTP response codes may be returned by the Receiver, indicating conditions outside of the scope of this transaction.

Note 2: It is recommended that the Receiver complement returned error code with a human readable description of the error condition.

13140 If an error condition cannot be automatically recovered, at a minimum, the error should be displayed to the user by the Sender.

#### 4.104.5 Security Considerations

Although the content of templates is not typically protected information, for consistency with other transactions on the client, which likely will involve protected information, it is reasonable to expect support for HTTPS.

##### 13145 4.104.5.1 Security Audit Considerations

None

### 4.105 Query Imaging Report Template [RAD-105]

#### 4.105.1 Scope

13150 This transaction is used to query templates from a Report Template Manager in the proper format.

#### 4.105.2 Actor Roles

**Table 4.105.2-1: Actor Roles**

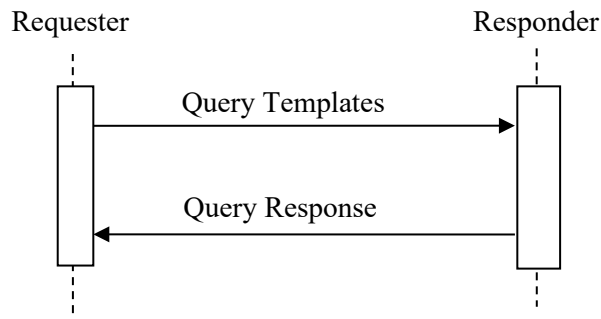
<b>Role:</b>	<b>Requester:</b> Requests a filtered list of templates from the Responder
<b>Actor(s):</b>	The following actor may play the role of Requester: <ul style="list-style-type: none"> <li>• Report Creator</li> </ul>
<b>Role:</b>	<b>Responder:</b> Provides a list of templates in response to the request
<b>Actor(s):</b>	The following actor may play the role of Responder: <ul style="list-style-type: none"> <li>• Report Template Manager</li> </ul>

13155 Transaction text specifies behavior for each role. The behavior of specific actors may also be specified when it goes beyond that of the general role.

#### 4.105.3 Referenced Standards

- IETF RFC2616 HyperText Transfer Protocol HTTP/1.1
- Extensible Markup Language (XML) 1.0 (Second Edition). W3C Recommendation 6 October 2000. <http://www.w3.org/TR/REC-xml>.
- 13160 • Dublin Core Metadata Element Set, standardized as ISO Standard 15836: 2009 and ANSI/NISO Standard Z39.85-2012. <http://dublincore.org/documents/dces/>

#### 4.105.4 Messages



**Figure 4.105.4-1: Interaction Diagram**

#### 13165 4.105.4.1 Query Templates Message

The Requester sends a message to the Responder indicating the list of templates it would like to receive.

A Responder shall support handling such messages from more than one Requester. A Requester may choose to support making requests to more than one Responder.

#### 13170 4.105.4.1.1 Trigger Events

1. A Requester needs to find templates for later use in anticipation of selecting an appropriate template for reporting in the future.
5. The user of a Requester, such as a Report Creator, invokes a template query.

#### 4.105.4.1.2 Message Semantics

13175 The message is an HTTP GET request.

To filter the template matches to be returned, the HTTP request shall include one or more of the following parameters. All parameter names and values are case-sensitive.

All parameters shall be supported by the Responder, and are optional for the Requester.

**Table 4.105.4.1.2-1: HTTP Query Parameters**

Parameter Name	REQ	Description	Values
title	O	Wildcard query of the <code>dcterms.title</code> tag.	This value shall be a string.
Identifier	O	Exact query of the <code>dcterms.identifier</code> tag.	This value shall be a properly defined Object identifier (OID) as specified in <a href="#">ITI TF-2: Appendix B</a> .
creator	O	Wildcard query of the <code>dcterms.creator</code> tag.	This value shall be a string.
Publisher	O	Wildcard query of the <code>dcterms.publisher</code> tag.	This value shall be a string.
License	O	Wildcard query of the <code>dcterms.license</code> tag.	This value shall be a string.
Lower_date	O	Query the date of the template for values on or after the specified lower date. See Note 1.	This value shall be encoded in the XML primitive date format. Multiple instances of this parameter are not permitted.
Upper_date	O	Query the date of the template for values on or before the specified upper date. See Note 1.	This value shall be encoded in the XML primitive date format. Multiple instances of this parameter are not permitted.
Language	O	Wildcard query of the <code>dcterms.language</code> tag.	This value shall be an ISO 639 two-letter language code.
Top_level_flag	O	Exact query of the <code>top-level-flag</code> tag.	This value shall be an <code>xsd:Boolean</code> .
Status	O	Exact query of the <code>status</code> tag.	This value shall be one of: DRAFT, ACTIVE, or RETIRED

Parameter Name	REQ	Description	Values
code_value	O	Exact query of the entry/coding_schemes/coding_scheme designator tag and entry/term/code value tag.	This value shall be a string containing the coding scheme from which the code value was drawn, and the code value itself separated by a colon. See Note 2.
Code_meaning	O	Wildcard query of the entry/term/code meaning tag.	This value shall be a string.
Limit	O	Limits the results returned to a maximum number. If omitted, all matching results shall be returned.	This value shall be an integer.
Offset	O	Skips the first number of matching results. If omitted, no results will be skipped.	This value shall be an integer.
Sort	O	Returns the results in alphabetical order of a specified field. If omitted, results are ordered by title.	This value shall be a string, being one of the query parameters aside from limit, offset, or sort.

13180 Note 1: **Lower\_date** and **upper\_date** are used to constrain the date of the template. For example, a **lower\_date** of 2010-01-01 and an **upper\_date** of 2010-12-31 will return all templates with a date in the year 2010. The query is inclusive of the date specified. If the value passed is not in XML primitive date format, an HTTP 400 error will be returned.

13185 Note 2: When searching for code value, the coding system must also be specified. This is done by concatenating the **coding\_scheme\_designator**, a colon, and the **code\_value**. For example, when searching in RadLex (2.16.840.1.113883.6.256) for Computed Tomography (RID10321), the **code\_value** to be queried for would be “2.16.840.1.113883.6.256:RID10321”.

The only binding required, for both the Requester and Responder, is the binding to the HTTP-GET. In this binding the Requester shall format the Query Templates message as follows:

13190 `http://<location>/IHETemplateService/?[parameter1_name]=[parameter1 value]&[parameter2_name]=[parameter2 value]`

13195 The `<location>` part of the URL shall contain the host name of the Responder, an optional port address, and may be followed by an optional path. The remainder of the URL, including `IHETemplateService` and the following request parameters shall not be changed. See the discussion about location in [ITI TF-2: 3.11.4.1.2 Message Semantics](#).

If no search parameters are provided, all **ACTIVE** templates match.

13200 For the parameters specified as wildcard search, a template matches if the text string in the parameter value appears in the corresponding attribute of the template. Wildcard matching is insensitive to case. For example, searching the title for “abdomen” would match templates with “CT Abdomen”.

13205 Specifying multiple, different parameters indicates an AND relation, meaning that both parameter values must be present for the template to match. For example, requesting that the title contains “CT” and the publisher contains “Hospital” would return only templates that met both of those criteria. However, specifying the same parameter multiple times indicates an OR relation, where only one of the parameter values must be present in the template. For example,

requesting that the title contains “CT” or the title contains “US” would return templates that match either of those criteria.

The Requester may perform the request to the web service utilizing HTTPS protocol. The Responder shall respond using HTTPS if requested.

- 13210 The Responder may return HTTP redirect responses to a request. The Requester can expect to receive an error response, or the data requested, or a request to look elsewhere for the data. The Requester shall follow redirects, but if a loop is detected, it may report an error.

#### 4.105.4.1.3 Expected Actions

- 13215 The Responder shall parse the request and create a response containing the template headers matching the parameters of the request as specified in Section 4.105.4.2.2.

The Responder shall handle multiple requests.

The Responder shall return the appropriate status code indicating success, warning, or failure as shown in Table 4.105.4.1.3-1.

**Table 4.105.4.1.3-1: HTTP Responses**

Service Status	HTTP1.1 Status Codes	Description
Failure (see Note 2)	503 – Busy	This indicates that the Responder was unable to perform the query because it was out of resources.
	401 — Unauthorized	This indicates that the Responder refused to return results because authentication credentials were not provided or not sufficient.
	400 – Bad Request	This indicates that the Responder was unable to provide the template list because one or more of the parameters are corrupt.
Success	200 – OK	This indicates that the request was successful and the Responder will list matching templates.

- 13220 Note 1: Other HTTP response codes may be returned by the Responder, indicating conditions outside of the scope of this transaction.

Note 2: It is recommended that the Responder complement the returned error code with a human readable description of the error condition.

#### 4.105.4.2 Template Response Message

- 13225 The Responder transmits the requested template headers to the Requester.

##### 4.105.4.2.1 Trigger Events

The Template Response message is created in response to a Responder receiving a Query Templates message.

#### 4.105.4.2.2 Message Semantics

13230 The Template Response message is an HTTP GET response.

The Template Response Message is expressed in XML.

A Responder shall format the response as described below. The Template Response message:

1. Shall begin with exactly one [1..1] XML declaration: `<?xml version="1.0" encoding="UTF-8"?>` declaring the character set used.

13235 2. Shall contain exactly one [1..1] `templates` element.

- a. The `templates` element may contain [0..\*] `template` elements, one for each matching report template.

- i. The `template` element shall contain an `href` attribute to indicate a URL to retrieve the template.

13240 

- ii. The `template` element shall contain exactly one [1..1] `title` element containing the name of the template.

- iii. The `template` element shall contain exactly one [1..1] `meta` element declaring the character set used: `<meta charset="UTF-8">`.

13245 

- iv. The `template` element may contain style information formatted according to HTML5 standards, using the `style` element for internal CSS style elements and the `link` element for CSS files.

- v. The `template` element shall contain one or more [1..\*] `meta` elements encoding Dublin Core metadata attributes for the template, as shown in Table 4.104.4.2.2-1.

13250 

1. The `name` property of the `meta` element will be used to specify the template attribute.

2. For Dublin Core template attributes, the “`dcterms`” namespace shall be used.

13255 

3. The `content` property of the `meta` element will be used to specify the value of the template attribute.

- vi. The `template` element shall contain exactly one [1..1] `script` element containing the entire contents of the `script` element for the template.

- vii. The `template` element shall comply with all other HTML5 constraints.

**Note:** The intent of each template node is to contain the contents of the head node of the actual template.

13260

```

13265 <?xml version="1.0" encoding="UTF-8"?>
13270 <templates>
13275   <template href="http://<location>/IHETemplateService/1.2.3.4.5">
13280     <title content="CT Brain">
13285     <meta charset="UTF-8">
13290     <meta name="dcterms.title" content="CT Brain" />
13295     <meta name="dcterms.identifier" content="1.2.3.4.5" />
13300     <meta name="dcterms.type" content="IMAGE_REPORT_TEMPLATE" />
13305     <meta name="dcterms.language" content="en" />
13310     <meta name="dcterms.publisher" content="Radiological Society of North
13315     America (RSNA)" />
13320     <meta name="dcterms.rights" content="May be used freely, subject to
13325     license agreement" />
13330     <meta name="dcterms.license"
13335     content="http://www.radreport.org/license.pdf" />
13340     <meta name="dcterms.date" content="2012-03-28" />
13345     <meta name="dcterms.creator" content="Flanders AE, et al." />
13350     <meta name="dcterms.contributor" content="Bozkurt S [coder]" />
13355     <meta name="dcterms.contributor" content="Kahn CE Jr [editor]" />
13360     <meta name="dcterms.contributor" content="American Society of
13365     Neuroradiology (ASNR)" />
13370     <script>
13375       <template_attributes>
13380         <top-level-flag>true</top-level-flag>
13385         <status>ACTIVE</status>
13390         <coding_schemes>
13395           <coding_scheme name="RADLEX"
13400           designator="2.16.840.1.113883.6.256" />
13405         </coding_schemes>
13410         <term type="modality">
13415           <code meaning="computed tomography" value="RID10321"
13420           scheme="RADLEX" />
13425         </term>
13430         <term type="body part">
13435           <code meaning="brain" value="RID6434" scheme="RADLEX" />
13440         </term>
13445       </template_attributes>
13450     </script>
13455   </template>
13460   <!--Additional template elements may appear here-->
13465 </templates>

```

**Figure 4.105.4.2.2-1: Example of the Template Response message**

#### 13305 **4.105.4.2.3 Expected Actions**

The Requester shall process the returned responses in a manner that is specific to its application. IHE does not mandate application-specific behavior but this may include, for example, rendering for the user the metadata received in the response and enabling the user to subsequently retrieve one of the templates using [RAD-103].

13310 If more sophisticated queries are required – more than what is provided for in Section 4.105.4.1.2, it is expected that the Responder will be capable of processing a large set of template responses and performing further filtering internally.

If the Requester receives an HTTP response code other than 200-OK, and cannot automatically recover, at a minimum, the Requester should display the error to the user.

13315 **4.105.5 Security Considerations**

Although the content of templates is not typically protected information, for consistency with other transactions on the client, which likely will involve protected information, it is reasonable to expect support for HTTPS.

**4.105.5.1 Security Audit Considerations**

13320 None.

**4.106 Invoke Image Display [RAD-106]**

This transaction is currently in the [Invoke Image Display \(IID\)](#) Trial Implementation Supplement.

**4.107 WADO-RS Retrieve [RAD-107]**

13325 **4.107.1 Scope**

The WADO-RS Retrieve [RAD-107] transaction accesses DICOM SOP Instances via an HTTP interface.

**4.107.2 Actor Roles**

13330 The Roles in this transaction are defined in the following table and may be played by the actors shown here:

**Table 4.107.2-1: Actor Roles**

<b>Role:</b>	<b>Requester:</b> Submit retrieve DICOM object requests
<b>Actor(s):</b>	The following actors may play the role of Requester: Imaging Document Consumer
<b>Role:</b>	<b>Responder:</b> Returns the requested DICOM object
<b>Actor(s):</b>	The following actors may play the role of Responder: Imaging Document Source



Transaction text specifies behavior for each Role. The behavior of specific actors may also be specified when it goes beyond that of the general role.

13335 **4.107.3 Referenced Standards**

RFC1738 Uniform Resource Locators (URL), <http://www.ietf.org/rfc/rfc1738.txt>

RFC2616 HyperText Transfer Protocol HTTP/1.1, <http://www.ietf.org/rfc/rfc2616.txt>

RFC7540 Hypertext Transfer Protocol Version 2 (HTTP/2), <https://tools.ietf.org/html/rfc7540>

13340 RFC4627 The application/json Media Type for JavaScript Object Notation (JSON),  
<http://www.ietf.org/rfc/rfc4627.txt>

Extensible Markup Language (XML) 1.0 (Second Edition). W3C Recommendation 6 October 2000, <http://www.w3.org/TR/REC-xml>

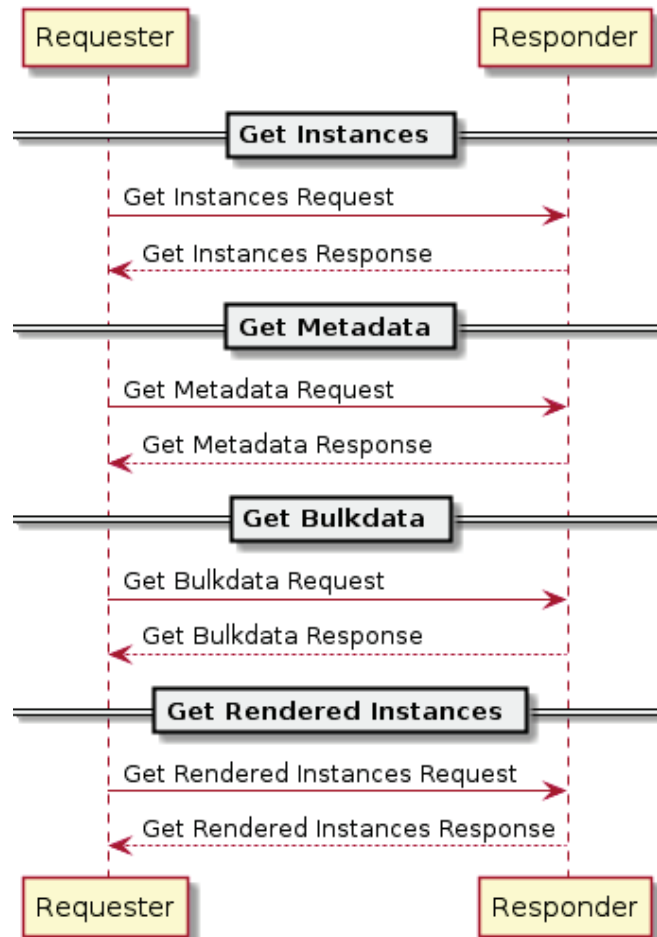
DICOM [PS3.18 Section 10.4](#): Web Services – Retrieve Transaction of the DICOM Studies Service

13345 DICOM [PS3.18 Annex F](#): DICOM JSON Model

DICOM [PS3.19 Annex A.1](#): Native DICOM Model

DICOM [PS3.19 Annex B](#): Interfaces Definition (WSDL and Schema)

#### 4.107.4 Messages



13350

**Figure 4.107.4-1: Interaction Diagram**

This transaction defines four request/response message pairs:

- Get Instances (Section 4.107.4.1 and 4.107.4.2)
- Get Metadata (Section 4.107.4.3 and 4.107.4.4)
- Get Bulkdata (Section 4.107.4.5 and 4.107.4.6)
- Get Rendered Instances (Section 4.107.4.7 and 4.107.4.8)

13355

A Requester shall support at least one of these request/response pairs; a Responder shall support all four pairs, as defined in DICOM.

##### 4.107.4.1 Get Instances Request Message

The Requester retrieves one or more DICOM instances from the Responder.

13360 **4.107.4.1.1 Trigger Events**

The Requester wishes to retrieve DICOM instances.

**4.107.4.1.2 Message Semantics**

The Get Instances Request message is a Retrieve transaction of the DICOM Studies Service. See DICOM [PS3.18 Section 10.4](#).

13365 The Requester is the User Agent, and the Responder is the Origin Server.

The message shall correspond to one of the Resources in Table 4.107.4.1.2-1.

**Table 4.107.4.1.2-1: Retrieve Transaction Instance Resources**

Resource	Reference
Study Instances	DICOM <a href="#">PS3.18 Section 10.4.1.1.1</a>
Series Instances	
Instance	
Frame Pixel Data	DICOM <a href="#">PS3.18 Section 10.4.1.1.6</a>

**4.107.4.1.2.1 Example of a Get Instances Request message**

13370 The following is an example of an HTTP Request URI for retrieving a composite DICOM object. This example uses an Accept header to request the DICOM SOP Instance returned in the Native DICOM binary format.

```
https://www.hospital.com/studies/2.999.1.59.40211.12345678.678910/series/2.999.1.59.40211.789001276.14556172.67789/instances/2.999.1.59.40211.2678810.87991027.899772.2
Accept: multipart/related; type=application/dicom
```

13375

**4.107.4.1.3 Expected Actions**

The Responder shall parse the request, prepare representation(s) of the Resource in the Selected Media Type (see DICOM [PS3.18 Section 10.4.2](#)), and return a response as described in Section 4.107.4.2.

13380 **4.107.4.1.3.1 XDS-I Backend Option**

The Responder shall use the grouped XDS-I Imaging Document Consumer to retrieve the requested imaging objects.

**4.107.4.2 Get Instances Response Message**

The Responder reports the outcome of the Get Instances Request Message.

13385 **4.107.4.2.1 Trigger Events**

The Responder completes processing of the Get Instances Request Message.

#### 4.107.4.2.2 Message Semantics

The message is a Response to a Retrieve Transaction as specified in DICOM [PS3.18 Section 10.4.3](#).

- 13390 The Requester is the User Agent, and the Responder is the Origin Server.  
The Responder shall provide a response as described in Table 4.107.4.2.2-1.

**Table 4.107.4.2.2-1: Response Message Semantics**

Resource	Reference
Study Instances	DICOM <a href="#">PS3.18 Section 10.4.3.3.1</a>
Series Instances	
Instance	
Frame Pixel Data	DICOM <a href="#">PS3.18 Section 10.4.3.3.6</a>

The Responder shall provide a response message header containing the appropriate status code indicating success, warning, or failure as described in DICOM [PS3.18 Section 10.4.3.1](#).

#### 13395 4.107.4.2.3 Expected Actions

The Requester shall accept the response.

The Requester shall follow redirects (responses with values of 301, 302, 303 or 307. See <https://tools.ietf.org/html/rfc7231#section-6.4> for details) unless a loop or security policy violation is detected.

#### 13400 4.107.4.3 Get Metadata Request Message

The Requester retrieves metadata regarding one or more DICOM instances from the Responder.

##### 4.107.4.3.1 Trigger Events

The Requester wishes to retrieve metadata of DICOM instances.

##### 4.107.4.3.2 Message Semantics

- 13405 The Get Metadata Request message is a Retrieve transaction of the DICOM Studies Service. See DICOM [PS3.18 Section 10.4](#).

The Requester is the User Agent, and the Responder is the Origin Server.

The message shall correspond to one of the Metadata Resources in Table 4.107.4.3.2-1.

**Table 4.107.4.3.2-1: Retrieve Transaction Metadata Resources**

Resource	Reference
Study Metadata	DICOM <a href="#">PS3.18 Section 10.4.1.1.2</a>
Series Metadata	
Instance Metadata	

13410 **4.107.4.3.2.1 Example of a Get Metadata Request message**

The following is an example of an HTTP Request URI for retrieving metadata for a study. This example uses an Accept header to request the metadata be returned in the Native DICOM Model in XML.

13415

```
https://www.hospital.com/studies/2.999.1.2.250.1.59.40211.12345678.6789
10/metadata
Accept: multipart/related; type=application/dicom+xml
```

**4.107.4.3.3 Expected Actions**

13420

The Responder shall parse the request, prepare representation of the Metadata Resource in the Selected Media Type (see DICOM [PS3.18 Section 10.4.2](#)), and return response described in Section 4.107.4.4.

**4.107.4.3.3.1 XDS-I Backend Option**

The Responder shall use the grouped XDS-I Imaging Document Consumer to retrieve the requested instance metadata.

**4.107.4.4 Get Metadata Response Message**

13425

The Responder reports the outcome of the Get Metadata Request Message.

**4.107.4.4.1 Trigger Events**

The Responder completes processing of the Get Metadata Request Message.

**4.107.4.4.2 Message Semantics**

13430

The message is a Response to a Retrieve Transaction as specified in DICOM [PS3.18 Section 10.4.3](#).

The Requester is the User Agent, and the Responder is the Origin Server.

The Responder shall provide a response as described in Table 4.107.4.4.2-1.

**Table 4.107.4.4.2-1: Response Message Semantics**

Resource	Reference
Study Metadata	DICOM <a href="#">PS3.18 Section 10.4.3.3.2</a> ,
Series Metadata	
Instance Metadata	

13435

The Responder shall provide a response message header containing the appropriate status code indicating success, warning, or failure as described in DICOM [PS3.18 Section 10.4.3.1](#).

**4.107.4.4.3 Expected Actions**

The Requester shall accept the response.

13440 The Requester shall follow redirects (responses with values of 301, 302, 303 or 307. See <https://tools.ietf.org/html/rfc7231#section-6.4> for details) unless a loop or security policy violation is detected.

#### 4.107.4.5 Get Bulkdata Request Message

The Requester retrieves bulk data from the Responder.

##### 4.107.4.5.1 Trigger Events

The Requester wishes to retrieve bulk data extracted from DICOM instances, using a URI.

13445 Note: The Requester must already know the URI to initiate this message.

##### 4.107.4.5.2 Message Semantics

The Get Bulkdata Request message is a Retrieve transaction of the DICOM Studies Service. See DICOM [PS3.18 Section 10.4](#).

The Requester is the User Agent, and the Responder is the Origin Server.

13450 The message shall correspond to the Bulkdata Resource in Table 4.107.4.5.2-1.

**Table 4.107.4.5.2-1: Retrieve Transaction Bulkdata Resources**

Resource	Reference
Bulkdata	DICOM <a href="#">PS3.18 Section 10.4.1.1.5</a>

##### 4.107.4.5.2.1 Example of a Get Bulkdata Request message

The following is an example of HTTP Request URI for retrieving all bulkdata for the resource.

13455 This example uses an Accept header to request uncompressed bulkdata.

```
https://www.hospital.com/stuff/hfslkhgkjhgkdjhdh
Accept: multipart/related; type=application/octet-stream
```

##### 4.107.4.5.3 Expected Actions

13460 The Responder shall parse the request, prepare representation of the Metadata Resource in the Selected Media Type (see DICOM [PS3.18 Section 10.4.2](#)), and return response as described in Section 4.107.4.6.

##### 4.107.4.5.3.1 XDS-I Backend Option

The Responder shall use the grouped XDS-I.b Imaging Document Consumer to retrieve the requested bulk data.

#### 4.107.4.6 Get Bulkdata Response Message

13465 The Responder reports the outcome of the Get Bulkdata Request Message.

#### 4.107.4.6.1 Trigger Events

The Responder completes processing of the Get Bulkdata Request Message.

#### 4.107.4.6.2 Message Semantics

13470 The message is a Response to a Retrieve Transaction as specified in DICOM [PS3.18 Section 10.4.3](#).

The Requester is the User Agent, and the Responder is the Origin Server.

The Responder shall include a multipart/related media type with one or more parts containing DICOM instance bulkdata according to Table 4.107.4.6.2-1.

13475

**Table 4.107.4.6.2-1: Response Message Semantics**

Resource	Reference
Bulkdata	DICOM <a href="#">PS3.18 Section 10.4.3.3.5</a> .

The Responder shall provide a response message header containing the appropriate status code indicating success, warning, or failure as described in DICOM [PS3.18 Section 10.4.3.1](#).

#### 4.107.4.6.3 Expected Actions

The Requester shall accept the response.

13480 The Requester shall follow redirects (responses with values of 301, 302, 303 or 307. See <https://tools.ietf.org/html/rfc7231#section-6.4> for details) unless a loop or security policy violation is detected.

#### 4.107.4.7 Get Rendered Instances Request Message

13485 The Requester retrieves one or more representations of a DICOM Resource, rendered as appropriate images or other representations, from the Responder.

##### 4.107.4.7.1 Trigger Events

The Requester wishes to retrieve rendered instances.

##### 4.107.4.7.2 Message Semantics

13490 The Get Rendered Instances Request message is a Retrieve transaction of the DICOM Studies Service. See DICOM [PS3.18 Section 10.4](#).

The Requester is the User Agent, and the Responder is the Origin Server.

The message shall correspond to one of the Rendered Resources in Table 4.107.4.7.2-1.

**Table 4.107.4.7.2-1: Retrieve Transaction Rendered Resources**

Resource	Reference
Rendered Series	DICOM <a href="#">PS3.18 Section 10.4.1.1.3</a>

Resource	Reference
Rendered Instance	
Rendered Frames	

Note: Although DICOM also includes a Rendered Study Resource, it is not required for this transaction.

13495 **4.107.4.7.2.1 Example of a Get Rendered Instances Request message**

The following is an example of an HTTP Request URI for retrieving a rendered composite DICOM object. This example uses an Accept header to request the DICOM SOP Instance returned in the jpeg format.

```
https://www.hospital.com/studies/2.999.1.59.40211.12345678.678910/series/2.999.1.59.40211.789001276.14556172.67789/instances/2.999.1.59.40211.2678810.87991027.899772.2/rendered
Accept: multipart/related; type=image/jpeg
```

**4.107.4.7.3 Expected Actions**

13500 The Responder shall parse the request, prepare representation(s) of the Rendered Resource in the Selected Media Type (see DICOM [PS3.18 Section 10.4.2](#)), and return a response as described in Section 4.107.4.8.

**4.107.4.7.3.1 XDS-I Backend Option**

13505 The Responder shall use the grouped XDS-I Imaging Document Consumer to retrieve the requested imaging objects and transcode to the requested rendered format.

**4.107.4.8 Get Rendered Instances Response Message**

The Responder reports the outcome of the Get Rendered Instances Request Message.

**4.107.4.8.1 Trigger Events**

The Responder completes processing of the Get Rendered Instances Request Message.

13510 **4.107.4.8.2 Message Semantics**

The message is a Response to a Retrieve Transaction as specified in DICOM [PS3.18 Section 10.4.3](#).

The Requester is the User Agent, and the Responder is the Origin Server.

13515 The Responder shall provide a response as described in Table 4.107.4.8.2-1 for Rendered Resources.

**Table 4.107.4.8.2-1: Response Message Semantics**

Resource	Reference
Rendered Series	DICOM <a href="#">PS3.18 Section 10.4.3.3.3</a>
Rendered Instance	



Resource	Reference
Rendered Frames	

The Responder shall provide a response message header containing the appropriate status code indicating success, warning, or failure as described in DICOM [PS3.18 Section 10.4.3.1](#).

#### 4.107.4.8.3 Expected Actions

13520 The Requester shall accept the response.

The Requester shall follow redirects (responses with values of 301, 302, 303 or 307. See <https://tools.ietf.org/html/rfc7231#section-6.4> for details) unless a loop or security policy violation is detected.

#### 4.107.5 Security Considerations

13525 Additional security considerations that may apply are discussed in RAD TF-1: 42.5 - WIA Security Considerations.

##### 4.107.5.1 Security Audit Considerations

13530 The [Radiology Audit Trail Option](#) in the ITI Audit Trail and Node Authentication (ATNA) Profile ([ITI TF-1: 9](#)) defines audit requirements for IHE Radiology transactions. See RAD TF-3:5.1.

### 4.108 Store Instances over the Web [RAD-108]

#### 4.108.1 Scope

This transaction is used by the Sender to send well-formed DICOM composite objects in either DICOM binary format, or in metadata and bulk data format to the Receiver for storage.

13535 The instances may be images, video, DICOM evidence documents (such as Key Image Notes, or Presentation States) or binary DICOM objects. Typically, the instances will have been newly created by the Sender. The instances may be sent as part of an existing DICOM Study, or part of a new Study.

#### 4.108.2 Actor Roles

13540 The Roles in this transaction are defined in the following table and may be played by the actors shown here:

**Table 4.108.2-1: Actor Roles**

<b>Role:</b>	<b>Sender:</b> Creates and sends well-formed DICOM composite objects
<b>Actor(s):</b>	The following actors may play the role of Sender: Image Capturer Lightweight Modality

<b>Role:</b>	<b>Receiver:</b> Receives objects from the Sender
<b>Actor(s):</b>	The following actors may play the role of Receiver: Image Manager

Transaction text specifies behavior for each Role. The behavior of specific actors may also be specified when it goes beyond that of the general Role.

13545 **4.108.3 Referenced Standards**

DICOM [PS3.3](#): Information Object Definitions

DICOM [PS3.4](#): Service Class Specifications

DICOM [PS3.5 Section B.2](#): UUID Derived UID

DICOM [PS3.18 Section 10.5](#): Web Services - Store Transaction of the DICOM Studies Service

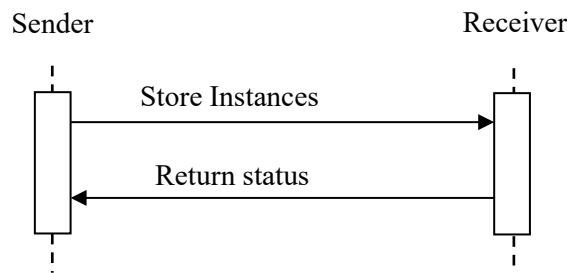
13550 DICOM [PS3.18 Annex F](#): DICOM JSON Model

DICOM [PS3.19 Section A.1](#): Native DICOM Model

DICOM [PS3.19 Annex B](#): Interfaces Definition (WSDL and Schema)

ISO/IEC 14496-14:2003: MPEG-4 Part 14

**4.108.4 Messages**



13555

**Figure 4.108.4-1: Interaction Diagram**

**4.108.4.1 Store Instances Message**

The Sender creates one or more instances and sends these instances to the Receiver for storage.

There may be one or more Senders storing instances to the same Receiver at any given time.

13560 **4.108.4.1.1 Trigger Events**

User or application initiates transfer of the acquired or created instances to the Receiver.

#### 4.108.4.1.2 Message Semantics

The Store Instances message is a Store transaction of the DICOM Studies Service. See [DICOM PS3.18 Section 10.5](#).

13565 The Sender is the User Agent. The Receiver is the Origin Server.

The message shall correspond to the DICOM Resource in Table 4.108.4.1.2-1.

**Table 4.108.4.1.2-1: Store Transaction DICOM Resources**

Resource	Reference
Study	DICOM <a href="#">PS3.18 Section 10.5.1.1.1</a>
Studies	

The Sender shall encode the instances per DICOM PS3.18 Section 10.5.1.4, using either:

- the binary DICOM method
- 13570 • Metadata and Bulkdata representations of SOP instances.

The Sender shall encode the Metadata and Bulkdata request as either:

- Array of DICOM JSON Model Object
- XML request messages as defined in the Native DICOM Model, with one message part per XML object

13575 Note: STOW-RS specifies Native DICOM Model as a baseline and JSON Model Object is optional. The Sender may support either one.

If the Sender needs to create new unique identifiers (e.g., for Study Instance UID, Series Instance UID or SOP Instance UID), it shall do so using UUID Derived UID mechanism specified in DICOM [PS3.5 Section B.2](#).

13580 Details about when it is appropriate to trigger the creation of a new Study/Series/SOP Instance are described in Section 4.8.4.1.1.1 “Study UIDs and Series UIDs”.

##### 4.108.4.1.2.1 Capture Device Attribute Requirements

13585 A Sender that is a Capture Device (i.e., digital camera) shall populate patient demographics according to Table 4.108.4.1.2-1 in order to provide the appropriate patient context for the created DICOM Instances. Additional patient demographics can be populated by the Sender according to DICOM [PS3.3 Section C.7.1.1](#).

Note: The means by which the Sender obtains the existing study values to populate these attributes is not specified here but might include using another transaction, extracting them from the integrated viewer, or via the user interface provided by the Sender.

13590 **Table 4.108.4.1.2-1: Critical Patient Demographics Attributes**

DICOM Attribute	Opt.	Existing Study Case (RAD TF-1: 38.4.2.2)
Patient’s Name (0010,0010)	R	Equal to existing study

DICOM Attribute	Opt.	Existing Study Case (RAD TF-1: 38.4.2.2)
Patient ID (0010,0020)	R	Equal to existing study
Issuer of Patient ID (0010,0021)	R	Equal to existing study
Patient's Birth Date (0010,0030)	R	Equal to existing study
Patient's Sex (0010,0040)	R	Equal to existing study

13595 When sending Metadata, the Sender shall populate Type 1 study attributes and also Type 2 study attributes for which the value is known for the SOP class being stored. If a reliable source of metadata attributes is available, values from that source shall be used, e.g., the study attributes may be populated by either extracting the study attributes from the integrated viewer, or via the user interface provided by the Sender. Otherwise, the Sender shall populate study attributes according to Table 4.108.4.1.2-2. The Sender populates additional study attributes according to DICOM [PS3.3 Section C.7.2.1](#) and [C.7.3.1](#).

**Table 4.108.4.1.2-2: Critical Study Attributes**

DICOM Attribute	Opt.	Existing Study Case (RAD TF-1: 38.4.2.2)
Study Instance UID (0020,000D)	R	Equal to existing study
Accession Number (0008,0050)	R	Equal to existing study
Issuer of Accession Number Sequence (0008,0051)	R	Equal to existing study
Series Date (0008,0021)	R	Acquisition date
Series Time (0008,0031)	R	Acquisition time
Series Description (0008,103E)	R	Possibly pre-configured or user input
Performed Procedure Step ID (0040,0253)	O	Internally generated
Performed Procedure Step Start Date (0040,0244)	O	Acquisition date
Performed Procedure Step Start Time (0040,0245)	O	Acquisition time
Performed Procedure Step Description (0040,0254)	O	Possibly pre-configured, user input, or from existing study
Request Attribute Sequence (0040,0275)	R	
> Reason for Requested Procedure (0040,1002)	R	Possibly pre-configured, user input, or from existing study
> Reason for Requested Procedure Code Sequence (0040,100A)	O	Possibly pre-configured, user input, or from existing study

#### 13600 4.108.4.1.2.2 Lightweight Modality Attribute Requirements

A Sender that is a Lightweight Modality in the Encounter-Based Imaging Workflow (EBIW) Profile shall populate metadata attributes as shown in Table 4.131.4.1.2-1.

#### 4.108.4.1.2.3 Single-frame Image

13605 The Sender shall encode compressed single-frame image pixel data elements in one message part per instance.

The Sender shall include all required attributes in the Native DICOM Model or the DICOM JSON Model Object for the appropriate DICOM SOP Class.

13610 Table 4.108.4.1.2.3-1 identifies recommended SOP Classes for commonly captured single-frame image types. DICOM defines more specific SOP Classes that may be used if applicable (see DICOM [PS3.3](#)).

**Table 4.108.4.1.2.3-1: Recommended SOP Classes for Single-frame Images**

Captured Image Type	SOP Class Name	SOP Class UID	IOD Specification defined in DICOM PS3.3
Photographs	VL Photographic Image Storage	1.2.840.10008.5.1.4.1.1.77.1.4	VL Photographic Image IOD
Screenshots	Secondary Capture Image Storage	1.2.840.10008.5.1.4.1.1.7	Secondary Capture Image IOD

According to DICOM [PS3.18 Section 10.5.1.4](#), the Image Pixel Description Macro attributes may be omitted. This exception is driven by the inability of certain mobile SDK or mobile clients (e.g., zero footprint browser client) to obtain the image pixel information.

13615

**Table 4.108.4.1.2.3-2: Image Pixel Description Macro Attributes**

Attribute Name	Tag
Samples per Pixel	(0028,0002)
Photometric Interpretation	(0028,0004)
Rows	(0028,0010)
Columns	(0028,0011)
Bits Allocated	(0028,0100)
Bits Stored	(0028,0101)
High Bit	(0028,0102)
Pixel Representation	(0028,0103)

##### 4.108.4.1.2.3.1 JPEG Storage Option

A Sender that supports the JPEG Storage Option shall be capable of sending images that are created using JPEG compression.

13620 If the Sender knows the Transfer Syntax of the JPEG image, the Sender shall encode the compressed pixel data using single-frame Media Types described in DICOM [PS3.18 Section 8.7.3.1](#).

If the Sender does not know the Transfer Syntax of the JPEG image, the Sender shall use a media type of `image/jpeg`.

13625 **4.108.4.1.2.3.2 PNG Storage Option**

A Sender that claims the PNG Storage Option shall be capable of creating images using lossless PNG compression with 8-bit per channel.

The Sender shall use a media type of `image/png`.

**4.108.4.1.2.4 Multi-frame Video**

13630 The Sender shall encode compressed multi-frame video pixel data elements in one message part per instance.

The Sender shall include all required attributes in the Native DICOM Model or DICOM JSON Model Object for the appropriate DICOM SOP Class.

13635 Table 4.108.4.1.2.4-1 identifies recommended SOP Classes for commonly captured multi-frame video types. DICOM defines more specific SOP Classes that may be used if applicable (see DICOM [PS3.3](#)).

**Table 4.108.4.1.2.4-1: Recommended SOP Classes for Multi-frame Videos**

Captured Video Type	SOP Class Name	SOP Class UID	IOD Specification defined in DICOM PS3.3
Video Photographs	Video Photographic Image Storage	1.2.840.10008.5.1.4.1.1.77.1.4.1	Video Photographic Image IOD

13640 According to DICOM [PS3.18 Section 10.5.1.4](#), the Image Pixel Description Macro attributes may be omitted; see Table 4.108.4.1.2.3-2. This exception is driven by the inability of certain mobile SDK or mobile clients (e.g., zero footprint browser client) to obtain the image pixel information.

**4.108.4.1.2.4.1 MPEG4 Storage Option**

13645 A Sender that supports the MPEG4 Storage Option shall be capable of sending videos that are encoded using AVC/H.264.

If the Sender knows the Transfer Syntax of the created video, the Sender shall encode the compressed video stream using a Media Type described in [DICOM PS3.18 Section 8.7.3.1](#).

If the Sender does not know the Transfer Syntax of the created video and the created video is using an MPEG4 container, then the Sender shall use a media type of `video/mp4`.

13650 The Sender shall support at least the `video/mp4` media type. When using the `video/mp4` media type, the MPEG-4 video stream shall be encoded using the AVC/H.264 encoding scheme and stored in the MP4 container format (ISO/IEC 14496-14:2003).

**4.108.4.1.2.5 Evidence Document Storage Option**

13655 The Sender shall encode the complete evidence document metadata in the first part of the multipart request.

The Sender shall include all required attributes in the Native DICOM Model or the DICOM JSON Model Object for the appropriate DICOM SOP Class that is used for the evidence document.

13660 Table 4.108.4.1.2.5-1 identifies recommended SOP Classes for commonly created evidence documents. DICOM defines more specific SOP Classes that may be used if applicable (see [DICOM PS3.3](#)).

**Table 4.108.4.1.2.5-1: Recommended SOP Classes for Evidence Document**

Captured Evidence Document Type	SOP Class Name	SOP Class UID	IOD Specification defined in DICOM PS3.3
Presentation State	Grayscale Softcopy Presentation State Storage	1.2.840.10008.5.1.4.1.1.11.1	Grayscale Softcopy Presentation State IOD
	Color Softcopy Presentation State Storage	1.2.840.10008.5.1.4.1.1.11.2	Color Softcopy Presentation State IOD
	Pseudo-Color Softcopy Presentation State Storage	1.2.840.10008.5.1.4.1.1.11.3	Pseudo-color Softcopy Presentation State IOD
Structured Report	Basic Text SR	1.2.840.10008.5.1.4.1.1.88.11	Basic Text SR IOD
	Enhanced SR	1.2.840.10008.5.1.4.1.1.88.22	Enhanced SR IOD
	Comprehensive SR	1.2.840.10008.5.1.4.1.1.88.33	Comprehensive SR IOD
	Comprehensive 3D SR	1.2.840.10008.5.1.4.1.1.88.34	Comprehensive 3D SR IOD
Key Object Selection	Key Object Selection Document	1.2.840.10008.5.1.4.1.1.88.59	Key Object Selection Document IOD
Encapsulated Document	Encapsulated PDF Storage	1.2.840.10008.5.1.4.1.1.104.1	Encapsulated PDF IOD
	Encapsulated CDA Storage	1.2.840.10008.5.1.4.1.1.104.2	Encapsulated CDA IOD

13665 The Sender shall include each encapsulated document in its own separate message part in the DICOM Request Message Body with the following HTTP headers:

- Encapsulated PDF document
  - Content-Type: application/pdf
  - Content-Location: {BulkDataURI}
- Encapsulated CDA document
  - Content-Type: text/xml
  - Content-Location: {BulkDataURI}
- Other encapsulated document

- Content-Type: application/octet-stream
- Content-Location: {BulkDataURI}

13675 The expected endpoint for DICOM Encapsulated PDF / CDA documents is a DICOM server.

Note: For transmission of plain PDF or CDA documents that are not intended to be DICOM encapsulated and stored to a DICOM server, the ITI [Mobile Access to Health Documents](#) (MHD) Profile provides a more appropriate mechanism for uploading electronic health records.

#### 4.108.4.1.2.6 DICOM Instance Storage Option

13680 The Sender shall encode each DICOM instance as a separate message part.

The Sender shall send the DICOM instances using DICOM binary format.

#### 4.108.4.1.3 Expected Actions

The Receiver shall accept and process the message payload.

13685 The Receiver shall accept Metadata and Bulkdata encoded in either the Native DICOM Model or DICOM JSON Model Object.

The Receiver shall at least support the SOP Classes defined in Tables 4.108.4.1.2.3-1, 4.108.4.1.2.4-1 and 4.108.4.1.2.5-1.

13690 If the message contents are not binary DICOM instances, the Receiver shall convert the DICOM Metadata and Bulkdata into DICOM binary instances according to the SOP Class UID specified in the metadata.

If the received object includes empty Image Pixel Macro Attributes (see Table 4.108.4.1.2-1), the Receiver shall populate them according to the Image Pixel Attribute Descriptions specified in DICOM [PS3.3 Section C.7.6.3.1](#).

13695 The Receiver shall store the DICOM binary instances (either received or converted) such that they can be later queried or retrieved in a fashion meeting the requirements defined for a DICOM Level 2 Storage SCP (refer to DICOM [PS3.4 Section B.4.1](#)).

If the received object includes the Transfer Syntax in the media type parameter, then the Receiver shall use the same Transfer Syntax when converting the Metadata and Bulkdata into DICOM binary instances.

13700 If the media type of the received object is `image/jpeg`, then the Receiver shall use the Transfer Syntax 1.2.840.10008.1.2.4.50 when converting the Metadata and Bulkdata into DICOM binary instances.

13705 If the media type of the received object is `video/mpeg2` or `video/mp4`, then the Receiver shall use the appropriate Transfer Syntax for the received object as defined in DICOM [PS3.18](#), Table 8.7.3-5.



#### 4.108.4.1.3.1 PNG Storage Option

A Receiver that supports the PNG Storage Option shall convert the encoded lossless PNG image into DICOM binary format with an appropriate standard uncompressed or lossless (reversible) compressed Transfer Syntax.

13710

**Table 4.108.4.1.3.1-1: Eligible Transfer Syntaxes for PNG Storage**

Media Type	Eligible Transfer Syntax	Description
image/png	1.2.840.10008.1.2	Implicit VR Little Endian: Default Transfer Syntax for DICOM
	1.2.840.10008.1.2.1	Explicit VR Little Endian
	1.2.840.10008.1.2.1.99	Deflated Explicit VR Little Endian
	1.2.840.10008.1.2.4.57	JPEG Lossless, Non-Hierarchical (Process 14)
	1.2.840.10008.1.2.4.70	JPEG Lossless, Non-Hierarchical, First-Order Prediction (Process 14 [Selection Value 1]): Default Transfer Syntax for Lossless JPEG Image Compression
	1.2.840.10008.1.2.4.80	JPEG-LS Lossless Image Compression
	1.2.840.10008.1.2.4.90	JPEG 2000 Image Compression (Lossless Only)
	1.2.840.10008.1.2.4.92	JPEG 2000 Part 2 Multi-component Image Compression (Lossless Only)
	1.2.840.10008.1.2.5	RLE Lossless

#### 4.108.4.2 Return Status Message

The Receiver reports the outcome of the Store Instances Message.

##### 4.108.4.2.1 Trigger Events

The Receiver receives a Store Instances Message.

13715

##### 4.108.4.2.2 Message Semantics

The Receiver shall return a response to the Sender according to DICOM [PS3.18 Section 10.5.3](#).

The Sender is the User Agent. The Receiver is the Origin Server.

Note: The Receiver may return a response before all processing is complete for the received object; for example, performing required image conversion asynchronously after sending the response. Sender implementers should be aware that such post-response processing may fail.

13720

Note: The Receiver will honor the HTTP Accept header field for encoding of the response message. However, if the Sender accepts both XML and JSON, then the Receiver can choose either format for the response message.

##### 4.108.4.2.3 Expected Actions

The Sender has no expected actions.

13725 **4.108.5 Security Considerations**

**4.108.5.1 Security Audit Considerations**

The [Radiology Audit Trail Option](#) in the IHE ITI [Audit Trail and Node Authentication](#) (ATNA) Profile ([ITI TF-1:9](#)) defines audit requirements for IHE Radiology transactions. See RAD TF-3: 5.1.1.

13730 **4.108.5.2 Transport Security**

In order to avoid unauthorized interception of private health information, the communication over HTTP may be secured by using HTTPS.

**4.109 Open Event Channel [RAD-109]**

13735 This transaction is currently in the [AI Workflow for Imaging \(AIW-I\)](#) Trial Implementation Supplement.

**4.110 Store Radiopharmaceutical Activity Information [RAD-110]**

**4.110.1 Scope**

13740 This section describes DICOM Storage requests of Structured Report objects containing DICOM Radiopharmaceutical Radiation Dose SR object (RRDSR) objects which detail radiopharmaceutical administration events. A Radiopharmaceutical Activity Supplier sends DICOM RRDSR objects to an Image Manager/Archive for storage so they can be later used for monitoring or analysis of patient radiation exposure.

**4.110.2 Actor Roles**

**Actor:** Radiopharmaceutical Activity Supplier

13745 **Role:** Generate DICOM RRDSR objects describing irradiation events performed by the Radiopharmaceutical Activity Supplier and store them to one or more receiving actors.

**Actor:** Image Manager/Archive.

**Role:** Accept and store DICOM RRDSR objects received from the Radiopharmaceutical Activity Supplier.

13750 **Actor:** Dose Information Consumer

**Role:** Accept and process DICOM RRDSR objects received from the Radiopharmaceutical Activity Supplier.

**Actor:** Dose Information Reporter

13755 **Role:** Accept and process DICOM RRDSR objects received from the Radiopharmaceutical Activity Supplier.

### 4.110.3 Referenced Standard

DICOM [PS 3.3 Section A.35.14](#): Radiopharmaceutical Dose SR IOD

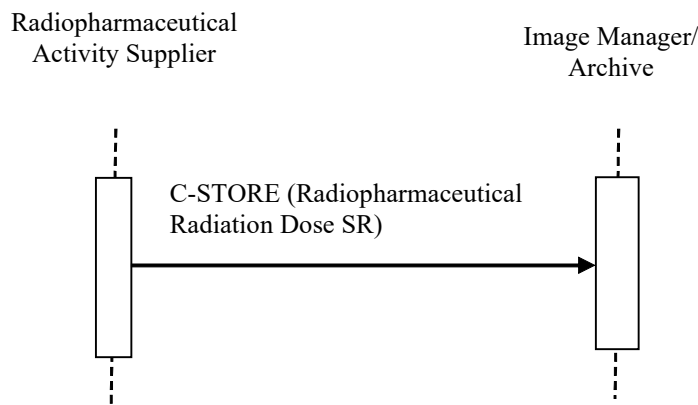
DICOM [PS 3.4 Annex B](#): Storage Service Class

DICOM [PS 3.4 Section B.5.1.5](#): Structured Reporting Storage SOP Classes

13760 DICOM [PS 3.16](#): Radiopharmaceutical Dose SR IOD Templates

DICOM [PS 3.17 Annex OOO](#): Radiopharmaceutical Radiation Dose Structured Report (Informative)

### 4.110.4 Messages



13765 Note: In the above diagram, the Dose Information Consumer and the Dose Information Reporter may also receive the C-STORE message.

**Figure 4.110.4-1: Interaction Diagram**

### 4.110.4.1 Store Radiopharmaceutical Dose Information

13770 The Radiopharmaceutical Activity Supplier shall implement the Radiopharmaceutical Radiation Dose SR Storage SOP Class in the role of SCU. The Image Manager/Archive, Dose Information Reporter and Dose Information Consumer shall implement the Dose Storage SOP Class in the role of SCP.

**Table 4.110.4.1-1: Radiopharmaceutical Dose Storage SOP Classes**

SOP Class UID	SOP Class Name
1.2.840.10008.5.1.4.1.1.88.68	Radiopharmaceutical Radiation Dose SR

#### 4.110.4.1.1 Trigger Events

13775 A radiopharmaceutical administration is one radioactive pharmaceutical administered to a patient.

A Radiopharmaceutical Activity Supplier shall record the relevant details for each radiopharmaceutical administration event. These details will be included in Radiopharmaceutical Radiation Dose Structured Reports as described below.

13780 The Radiopharmaceutical Activity Supplier shall compose an appropriate DICOM RRDSR Object containing the radiopharmaceutical administration event and send the DICOM RRDSR object to the configured destinations.

When two or more radiopharmaceuticals are administered, each constitutes a separate administration event, and corresponds to a separate RRDSR.

13785 **4.110.4.1.2 Message Semantics**

The Radiopharmaceutical Activity Supplier Actor shall use the DICOM C-STORE message to send DICOM RRDSR objects encoded as DICOM SR objects. These objects serve as a record of irradiation performed by the device.

13790 The Radiopharmaceutical Activity Supplier shall be capable of sending the Dose object to multiple destinations. The primary storage destination is generally an Image Manager/Archive. However, Dose Information Reporters or Dose Information Consumers may also appear as configured destinations when they need to receive timely DICOM RRDSR objects without having to repeatedly poll the Image Manager/Archive.

13795 The Radiopharmaceutical Activity Supplier is responsible for delivery of DICOM RRDSR objects to the destination in spite of intermittent connections (e.g., due to mobile modalities, network trouble, or the destination being down).

Radiopharmaceutical Activity Suppliers which report on radiopharmaceutical administration events shall be capable of producing an SR compliant with TID 10021.

13800 The Radiopharmaceutical Administration Event UID in the template allows receiving systems to recognize duplicate events.

The Synchronization Module shall be included in the RRDSR.

Table 4.110.4.1.2-1 describes how some attributes in the RRDSR shall be populated by the Radiopharmaceutical Activity Supplier:

**Table 4.110.4.1.2-1: Radiopharmaceutical Administration Dose Context Attributes**

Attribute Name	Tag	Requirement
Series Description	(0008,103E)	Shall have a value in the appropriate language for local use that means the equivalent of “Radiation Dose Information”, or similar.
Referenced Performed Procedure Step Sequence	(0008,1111)	Shall be empty.

Attribute Name	Tag	Requirement
Performed Procedure Code Sequence	(0040,A372)	Shall be copied from the Requested Procedure Code Sequence in the Modality Worklist, unless the procedure is changed, in which case this shall be empty.
Referenced Request Sequence (0040,A370) >Requested Procedure Description	(0032,1060)	Shall be copied from the relevant acquisition Modality Worklist entry
Admitting Diagnoses Description	(0008,1080)	Shall be copied from the relevant acquisition Modality Worklist entry. This can facilitate checking compliance to indication-based dose policies.
Admitting Diagnoses Code Sequence	(0008,1084)	
Referenced Request Sequence (0040,A370) >Reason for the Requested Procedure	(0040,1002)	
Referenced Request Sequence (0040,A370) >Reason for Requested Procedure Code Sequence	(0040,100A)	
Patient's Weight	(0010,1030)	Shall be populated with a value that is not zero. May be copied from the relevant acquisition Modality Worklist entry, if present, only if it is not provided by the Radiopharmaceutical Activity Supplier (e.g., via operator entry). The intent is to use the most recent date, though the date of the weight measurement is not provided by the Worklist entry.
Patient's Size	(0010,1020)	I.e., height. Shall be populated with a value that is not zero. May be copied from the relevant acquisition Modality Worklist entry, if present, only if it is not provided by the Radiopharmaceutical Activity Supplier (e.g., via operator entry).
Patient's Age	(0010,1010)	Shall be present. May be filled from any valid source (e.g., computed from Patient's Birthdate and Study Date, copied from the relevant acquisition Modality Worklist entry, if present, only if it is not provided by the Radiopharmaceutical Activity Supplier (e.g., via operator entry).
Patient's Sex	(0010,0040)	Shall be present. May be copied from the relevant acquisition Modality Worklist entry, if present, only if it is not provided by the Radiopharmaceutical Activity Supplier via operator entry.

13805

#### 4.110.4.1.2.1 Cross-referencing DICOM RRDSR Objects and Image Objects

See RAD TF-2: 4.8.4.1.2.10, which requires Acquisition Modalities to record the Radiopharmaceutical Administration Event UID (0008,3012) in related image instances.

13810

The Radiopharmaceutical Radiation Dose Template (TID 10021) does not include references to images since the instances sent to the Image Manager/Archive are typically generated some time after the irradiation is complete.

Note that it is possible for a study to have DICOM RRDSR objects but no image objects. For example, a radioactive iodine uptake test, or thyroid uptake test, involves administration of radioactive iodine but does not include an imaging step (i.e., no acquisition modality).

13815 **4.110.4.1.3 Expected Actions**

The Image Manager/Archive shall support Level 2 (Full) storage, which means all DICOM Type 1, 2 and 3 attributes (public and private) are stored. It shall accept the DICOM RRDSR objects, store them, and make them available for query/retrieval.

13820 The Dose Information Reporter and Dose Information Consumer shall accept the DICOM RRDSR objects. The DICOM RRDSR objects shall be processed according to the features, configuration, and business logic of the Dose Information Reporter or Dose Information Consumer product. Possibilities include display, processing, analysis, printing, export, etc. At a minimum, the Dose Information Reporter shall provide the capability to the review and do summary analysis of the dose data.

13825 Dose Information Reporter Actors shall be capable of processing DICOM [TID 10021](#).

13830 When multiple DICOM RRDSR objects are received, the same Radiopharmaceutical Administration Event (as identified by its Radiopharmaceutical Administration Event UID) may be referenced in multiple DICOM RRDSR objects. It is the responsibility of the recipient to recognize such duplicate Radiopharmaceutical Administration Events when processing or generating reports based on the retrieved data.

### **4.111 [RAD-111] – [RAD-120]**

These transactions are currently in the [Cross-Enterprise Reading Workflow Definition \(XRR-WD\)](#) Trial Implementation Supplement

### **4.121 Store Protocol [RAD-121]**

13835 This transaction is currently in the [Managing Acquisition Protocols \(MAP\)](#) Trial Implementation Supplement.

### **4.122 Query Protocol [RAD-122]**

This transaction is currently in the [Managing Acquisition Protocols \(MAP\)](#) Trial Implementation Supplement.

13840 **4.123 Retrieve Protocol [RAD-123]**

This transaction is currently in the [Managing Acquisition Protocols \(MAP\)](#) Trial Implementation Supplement.

### **4.124 Transfer Multiple Events [RAD-124]**

13845 This transaction is currently in the [Standardized Operational Log of Events \(SOLE\)](#) Trial Implementation Supplement.

#### 4.125 Store Protocol Approval [RAD-125]

This transaction is currently in the [Managing Acquisition Protocols \(MAP\)](#) Trial Implementation Supplement.

#### 4.126 Query Protocol Approval [RAD-126]

13850 This transaction is currently in the [Managing Acquisition Protocols \(MAP\)](#) Trial Implementation Supplement.

#### 4.127 Retrieve Protocol Approval [RAD-127]

This transaction is currently in the [Managing Acquisition Protocols \(MAP\)](#) Trial Implementation Supplement.

#### 13855 4.128 Send Imaging Result [RAD-128]

This transaction is currently in the [Results Distribution \(RD\)](#) Trial Implementation Supplement.

#### 4.129 QIDO-RS Query [RAD-129]

##### 4.129.1 Scope

13860 The QIDO-RS Query transaction searches for DICOM study, series, or instances via an HTTP interface.

##### 4.129.2 Actor Roles

The Roles for this transaction are defined in the following table and may be played by the actors shown here:

**Table 4.129.2-1: Actor Roles**

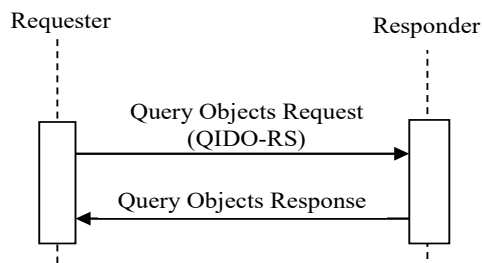
<b>Role:</b>	<b>Requester:</b> Queries for study metadata
<b>Actor(s):</b>	The following actors may play the role of Requester: Imaging Document Consumer
<b>Role:</b>	<b>Responder:</b> Returns metadata for matching query results
<b>Actor(s):</b>	The following actors may play the role of Responder: Imaging Document Responder

13865 Transaction text specifies behavior for each Role. The behavior of specific actors may also be specified when it goes beyond that of the general Role.

### 4.129.3 Referenced Standards

- RFC1738 Uniform Resource Locators (URL), <http://www.ietf.org/rfc/rfc1738.txt>
- RFC2616 Hypertext Transfer Protocol HTTP/1.1, <http://www.ietf.org/rfc/rfc2616.txt>
- 13870 RFC7540 Hypertext Transfer Protocol Version 2 (HTTP/2), <https://tools.ietf.org/html/rfc7540>
- RFC4627 The application/json Media Type for JavaScript Object Notation (JSON), <http://www.ietf.org/rfc/rfc4627.txt>
- Extensible Markup Language (XML) 1.0 (Second Edition). W3C Recommendation 6 October 2000, <http://www.w3.org/TR/REC-xml>
- 13875 DICOM [PS3.4 Annex C](#): Query/Retrieve Service Class
- DICOM [PS3.18 Section 10.6](#): Web Services - Search Transaction of the DICOM Studies Service

### 4.129.4 Messages



13880 **Figure 4.129.4-1: Interaction Diagram**

#### 4.129.4.1 Query Objects Request Message

The Requester queries the Responder for studies, series or instances based on some query keys. The Requester shall support making requests to more than one Responder. The Responder shall support handling request from more than one Requester.

##### 13885 4.129.4.1.1 Trigger Events

A user or an automated function on the Requester needs to access information about studies, series or instances matching various metadata parameters.

##### 4.129.4.1.2 Message Semantics

13890 The Query Objects Request message is a Search transaction of the DICOM Studies Service. See DICOM [PS3.18 Section 10.6](#).

The Requester is the User Agent. The Responder is the Origin Server.



The Requester shall issue the Query Objects Request using the QIDO-RS Query endpoint provided by the Responder.

13895 Note: A Responder that supports that XDS-I Backend Option will have two endpoints, one for QIDO-RS and one for the XDS-I Backend Option. The Requester will determine which endpoint to use for a given query request.

The message shall correspond to one of the Target Resources listed in Table 4.129.4.1.2-1. The only binding required for both the Requester and Responder is HTTP-GET.

The Requester shall support at least one Target Resource; a Responder shall support all Target Resources in Table 4.129.4.1.2-1.

13900

**Table 4.129.4.1.2-1: Search Transaction Target Resources**

Resource	URI Template	Expected Response
All Studies	http://<location>/studies {?search*}	All studies that satisfy the query parameters
Study's Series	http://<location>/studies/ {study}/series {?search*}	All series that satisfy the query parameters
All Series	http://<location>/series {?search*}	
Study's Series' Instances	http://<location>/studies/ {study}/series/ {series}/instances {?search*}	All instances that satisfy the query parameters
Study's Instances	http://<location>/studies/ {study}/ instances {?search*}	
All Instances	http://<location>/instances {?search*}	

Note: Support of the fuzzy semantic matching parameter by the Responder as defined in DICOM [PS3.18 Section 8.3.4.2](#) is optional.

The parameters of the message are defined in Table 4.129.4.1.2-2.

**Table 4.129.4.1.2-2: Search Query Parameters**

Parameter	Description	Notes
<location>	The host name, an optional port address, and may be followed by an optional path	See the discussion about location in <a href="#">ITI TF-2: 3.11.4.1.2 Message Semantics</a> .
{study}	Study Instance UID of the study from which series or instances are to be returned.	
{series}	Series Instance UID of the series from which instances are to be returned.	
{?search*}	A set of attribute/value pairs for matching keys, or a set of 'includefield' attributes for return keys, or 'all' for all available attributes. This parameter may include 'limit' and 'offset' attributes to paginate a search response.	See DICOM <a href="#">PS3.18 Section 8.3.4</a> for syntax details.

13905 The message shall include the header parameters defined in Table 4.129.4.1.2-3 to indicate the media type of the response.

**Table 4.129.4.1.2-3: Search transaction Header Parameters**

Header Name	REQ	Description
Accept	R	The representation scheme being requested from the RESTful service. Refer to DICOM <a href="#">PS3.18 Section 8.3.3.1</a> .

The Requester uses one or more matching keys as search criteria to obtain the list of matching entries in the Responder using a selected Resource (Table 4.129.4.1.2-1).

- 13910 The Requester shall support all keys required for the SCU as defined in RAD TF-2: Table 4.14-1, and the keys in Table 4.14-3.

Note: For XDS-I Backend Option related requirements on accession number, see Table 4.129.4.1.3.1-1.

The Requester may implement one or more of the following sets of matching or return keys for the Query SCU:

13915

**Table 4.129.4.1.2-4: Additional SCU Query Keys**

Query Key Specifications	Type of Objects
RAD TF-2: Table 4.15-1	Presentation State Objects
RAD TF-2: Table 4.26-1	DICOM Structured Report Objects
RAD TF-2: Table 4.30-1	Key Image Notes

#### 4.129.4.1.2.1 XDS-I Backend Option

The Requester shall issue the Query Objects Request message (Section 4.129.4.1) using the endpoint designated by the Responder for the XDS-I Backend Option.

- 13920 If the Requester does not specify Patient ID (0010,0020) and Issuer of Patient ID (0010,0021) as query matching keys, the Responder will be unable to perform a Registry Stored Query [ITI-18] that returns any matches.

For Requesting Service Code Sequence (0032,1034) as a matching key, the Requester may use values from DICOM [PS3.16 Context Group CID 7030](#) “Institutional Departments, Units and Services”.

#### 13925 4.129.4.1.2.2 Example of a Search transaction

The following is an example HTTP Request URI for querying DICOM instance level attributes for all instances in the study with Study Instance UID 2.999.1.59.40211.12345678.678910:

```
https://www.hospital.com/studies/2.999.1.59.40211.12345678.678910/instances
```

- 13930 This example does not specify an Accept header. Therefore, the results will be encoded in the DICOM JSON format by default.

#### 4.129.4.1.3 Expected Actions

The Responder shall parse the request, perform the search indicated using the matching rules in DICOM [PS3.18 Section 8.3.4](#), and return a response.

13935 It is the responsibility of the Responder to ensure that it includes the current patient and procedure information in the query results.

For requests sent to the QIDO-RS endpoint, the response shall be a Query Objects Response message (Section 4.129.4.2).

13940 The Responder shall support all query matching and return keys required for the SCP as defined in the sections referenced in Table 4.129.4.1.3-1:

**Table 4.129.4.1.3-1: SCP Query Matching and Return Keys**

Query Key Specifications	Type of Objects
RAD TF-2: Table 4.14-1	Image Objects
RAD TF-2: Table 4.15-1	Presentation State Objects
RAD TF-2: Table 4.26-1	DICOM Structured Report Objects
RAD TF-2: Table 4.30-1	Key Image Notes
RAD TF-2: Table 4.14-3	Query Matching and Return Keys for Enterprise Identity

#### 4.129.4.1.3.1 XDS-I Backend Option

A Responder that claims the XDS-I Backend Option shall also support the following requirements for requests sent to the XDS-I Backend Option endpoint.

13945 The Responder shall support the Registry Stored Query [ITI-18] transaction as an XDS Document Consumer using the FindDocuments query in [ITI TF-2: 3.18.4.1.2.3.7.1](#) and FindDocumentsByReferenceId query in [ITI TF-2: 3.18.4.1.2.3.7.14](#). The Responder may support other stored queries defined in [ITI-18].

A Responder executes the following general steps:

- 13950
- Receives the Query Objects Request message (Section 4.129.4.1)
  - Maps the query parameters into Registry Stored Query [ITI-18] request parameters
  - Receives the Registry Stored Query response
  - Maps the Registry Stored Query response into a Query Objects Response message (Section 4.129.4.2)

13955 The Responder shall populate Registry Stored Query Parameters as defined in Table 4.129.4.1.3.1-1.

The following attributes have no direct correspondences in the Registry Stored Query but are required to be supported by Responder as matching keys. These attributes may be available in the XDS-I manifest or the instances referenced by the manifest.

- 13960
- Patient’s Name (0010,0010)
  - Referring Physician’s Name (0008,0090)
  - Study ID (0020,0010)

**Table 4.129.4.1.3.1-1: Populating Registry Stored Query Parameters**

Registry Stored Query Parameter	QIDO-RS Matching Keys	Details
<b>Required Parameters for FindDocuments and FindDocumentsByReferenceId Stored Queries</b>		
\$XDSDocumentEntryPatientId	Patient ID (0010,0020) and Issuer of Patient ID (0010,0021)	This Patient ID and Issuer of Patient ID shall correspond to the XDS Affinity Domain Patient ID. Otherwise, the Responder shall return no matches.
\$XDSDocumentEntryStatus	N/A	\$XDSDocumentEntryStatus will usually have the value of “urn:oasis:names:tc:ebxml-regrep:StatusType:Approved” in order to return the active version of the manifest.
\$XDSDocumentEntryFormatCode	N/A	The Responder shall use “1.2.840.10008.5.1.4.1.1.88.59” (DICOM KOS SOP Class UID) as the Format Code Value and “1.2.840.10008.2.6.1” (DICOM UID Registry UID Value) as the Format Coding Scheme OID. The target of all QIDO-RS Queries that are mapping to Registry Stored Query [ITI-18] in an XDS-I environment are studies represented as XDS-I Manifest documents.
<b>Parameters for FindDocumentsByReferenceId Stored Query Only (Note 1)</b>		
\$XDSDocumentEntryReferenceIdList	Accession Number (0008,0050) and Issuer of Accession Number Sequence (0008,0051)	<p>If Accession Number is defined as a matching key in the QIDO-RS query, then the Responder shall use the FindDocumentsByReferenceId query.</p> <p>If the Requester specifies Accession Number but does not include Issuer of Accession Number Sequence in the QIDO-RS query as a matching key, then the Responder shall return no matches.</p>
\$XDSDocumentEntryReferenceIdList	Study Instance UID (0020,000D)	Study Instance UID is available in the XDS-I Manifest if not available in the ReferencedIdList.

Registry Stored Query Parameter	QIDO-RS Matching Keys	Details
<b>Optional Parameters Available for Both Stored Queries</b>		
<p>\$XDSDocumentEntryServiceStartTimeFrom</p> <p>\$XDSDocumentEntryServiceStopTimeTo</p>	<p>Study Date (0008,0020) and Study Time (0008,0030)</p>	<p>Study Date and Study Time are specified as two single value matching keys. The Responder shall map both values to \$XDSDocumentEntryServiceStartTimeFrom. See <a href="#">ITI TF-2: 3.18.4.1.2.3.3</a>.</p> <p>If only Study Date is specified as a matching key, then Responder shall set the time to be the midnight (00:00:00) when creating the UTC time.</p> <p>QIDO-RS supports range matching for Study Date and Study Time, while Registry Stored Query [ITI-18] defines two separate query parameters for time range. Therefore, the Responder shall extract the beginning of the range matching constraint (if specified) as \$XDSDocumentEntryServiceStartTimeFrom, and the end of the range matching constraint (if specified) as \$XDSDocumentEntryServiceStopTimeTo.</p> <p>Note: The Search transaction uses Combined Datetime matching semantics. See DICOM <a href="#">PS3.18 Section 8.3.4.1.1</a>.</p>
<p>\$XDSDocumentEntryEventCodeList</p>	<p>Modalities in Study (0008,0061)</p>	<p>Only a single modality can be specified as a matching key. Unlike Registry Stored Query [ITI-18], the QIDO-RS Query [RAD-129] does not support query semantics with multiple values.</p> <p>The Responder shall return records that match any one of the modalities found in the eventCodeList.</p> <p>The original Requester may want to find studies with a specific combination of modalities. Since the Requester can only ask the Responder for a single modality, the Requester will need to use one of the modalities as a matching key, and then locally filter the results by looking for the second modality in Modalities in Study (0008,0061). Alternatively, one may send multiple queries, one per modality, and compare the results.</p> <p>If both Modalities in Study and Anatomic Regions in Study Code Sequence are specified as matching keys, then the Responder shall combine them using the logical AND semantics (see <a href="#">ITI TF-2: 3.18.4.1.2.3.5</a>).</p>

Registry Stored Query Parameter	QIDO-RS Matching Keys	Details
\$XDSDocumentEntryEventCodeList	Anatomic Regions in Study Code Sequence (0008,0063)	If both Modalities in Study and Anatomic Regions in Study Code Sequence are specified as matching keys, then the Responder shall combine them using the logical AND semantics (see <a href="#">ITI TF-2: 3.18.4.1.2.3.5</a> ).
\$XDSDocumentEntryTypeCode	Procedure Code Sequence (0008,1032)	
\$XDSDocumentEntryPracticeSettingCode	Requesting Service Code Sequence (0032,1034)	<p>\$XDSDocumentEntryPracticeSettingCode communicates the clinical specialty where the act that resulted in the document was performed (e.g., Family Practice, Laboratory, Radiology). The list of acceptable values is constrained by the organization managing the XDS Document Registry (i.e., the XDS Affinity Domain).</p> <p>There is no direct correspondence in DICOM. The Responder may be able to use Requesting Service Code Sequence to map to the appropriate practice setting code defined by the affinity domain.</p> <p>See Section 4.129.4.1.2.1 for Requester behavior.</p>
<b>Other Optional Stored Query Parameters With No Mapping</b>		
\$XDSDocumentEntryConfidentialityCode	N/A	The Responder may include values for this parameter based on local policy requirements.
\$XDSDocumentEntryClassCode	N/A	The Responder may use an appropriate value for imaging study defined by the affinity domain.
\$XDSDocumentEntryHealthcareFacilityTypeCode	N/A	The Responder may use an appropriate value to limit the imaging study returned as defined by the Affinity Domain.
\$XDSDocumentEntryType	N/A	<p>The Responder may use an appropriate value to limit the imaging study returned as defined by the Affinity Domain.</p> <p>If no value is specified, then only Stable Document Entries will be returned. See <a href="#">ITI TF-2: 3.18.4.1.2.3.6.2</a> for details.</p>
\$XDSDocumentEntryAuthorPerson	N/A	No mapping is provided for these parameters because the Requester cannot provide meaningful input from a QIDO-RS query. The Responder is not required to support these parameters.
\$XDSDocumentEntryCreationTimeFrom	N/A	
\$XDSDocumentEntryCreationTimeTo	N/A	
\$XDSDocumentEntryServiceStartTimeTo	N/A	
\$XDSDocumentEntryServiceStopTimeFrom	N/A	

Note 1: Only an XDS Document Registry that supports the Reference Id Option is able to respond to FindDocumentsByReferencedId queries.

13965

The Responder shall obtain the necessary information to populate the Query Objects Response message.

When populating QIDO-RS Return Keys using Document Sharing metadata, the Responder shall follow the requirements in RAD TF-2: 4.68.4.1.2.3.2 and 4.68.4.1.2.3.3.

13970

Note: If it is necessary to obtain additional information to populate the QIDO-RS response, the Responder may consider using a combination of the metadata provided by the Registry Stored Query, retrieved XDS-I manifest, retrieving instances referenced by the manifest from the Imaging Document Source, or some other source (e.g., PDQ to resolve Patient's Name to Affinity Domain Patient ID), etc.

#### **4.129.4.2 Query Objects Response Message**

13975

The Responder returns the information about matching DICOM studies, series or instances.

##### **4.129.4.2.1 Trigger Events**

The Responder completes processing of the Query Objects Request message.

##### **4.129.4.2.2 Message Semantics**

The message is a response to a Search transaction as specified in DICOM [PS3.18 Section 10.6.3](#).

13980

The Requester is the User Agent, and the Responder is the Origin Server.

The Responder shall support the return keys as specified in Table 4.129.4.1.3-1.

##### **4.129.4.2.3 Expected Actions**

The Requester shall accept the response.

13985

The Requester shall follow redirects (responses with values of 301, 302, 303 or 307. See <https://tools.ietf.org/html/rfc7231#section-6.4> for details) unless a loop or security policy violation is detected.

#### **4.129.5 Security Considerations**

Additional security considerations that may apply are discussed in RAD TF-1: 42.5 - WIA Security Considerations.

13990

##### **4.129.5.1 Security Audit Considerations**

The [Radiology Audit Trail Option](#) in the IHE ITI Audit Trail and Node Authentication Profile ([ITI TF-1: 9](#)) defines audit requirements for IHE Radiology transactions. See RAD TF-3: 5.1.

#### **4.130 Get Encounter Imaging Context [RAD-130]**

13995

This transaction is currently in the [Encounter-Based Imaging Workflow \(EBIW\)](#) Trial Implementation Supplement.

#### **4.131 Store Encounter Images [RAD-131]**

This transaction is currently in the [Encounter-Based Imaging Workflow \(EBIW\)](#) Trial Implementation Supplement.

#### **4.132 Notify of Imaging Results [RAD-132]**

14000 This transaction is currently in the [Encounter-Based Imaging Workflow \(EBIW\)](#) Trial Implementation Supplement.

#### **4.133 Query for Patient Studies [RAD-133]**

This transaction is currently in [Import and Display of External Priors \(IDEP\)](#) Trial Implementation Supplement.

#### **4.134 Study Root Query for Patient ID [RAD-134]**

This transaction is currently in [Import and Display of External Priors \(IDEP\)](#) Trial Implementation Supplement.

#### **4.135 Send Import Notification [RAD-135]**

14010 This transaction is currently in [Import and Display of External Priors \(IDEP\)](#) Trial Implementation Supplement.

#### **4.136 Display Analysis Results [RAD-136]**

This transaction is currently in the [AI Results \(AIR\)](#) Trial Implementation Supplement.

#### **4.137 Query Analysis Results [RAD-137]**

This transaction is currently in the [AI Results \(AIR\)](#) Trial Implementation Supplement.

#### **4.138 Store Contrast Information [RAD-138]**

14015 This transaction is currently in the [Contrast Administration Management \(CAM\)](#) Trial Implementation Supplement.

#### **4.139 Query Contrast Information [RAD-139]**

14020 This transaction is currently in the [Contrast Administration Management \(CAM\)](#) Trial Implementation Supplement.

#### **4.140 Retrieve Contrast Information [RAD-140]**

This transaction is currently in the [Contrast Administration Management \(CAM\)](#) Trial Implementation Supplement.

#### **4.141 Store Multimedia Report [RAD-141]**

14025 This transaction is currently in the [Interactive Multimedia Report \(IMR\)](#) Trial Implementation Supplement.



#### **4.142 Display Multimedia Report [RAD-142]**

This transaction is currently in the [Interactive Multimedia Report \(IMR\)](#) Trial Implementation Supplement.

14030 **4.143 Find Multimedia Report [RAD-143]**

This transaction is currently in the [Interactive Multimedia Report \(IMR\)](#) Trial Implementation Supplement.

#### **4.144 Retrieve Rendered Multimedia Report [RAD-144]**

14035 This transaction is currently in the [Interactive Multimedia Report \(IMR\)](#) Trial Implementation Supplement.

#### **4.145 Send Procedural Observation [RAD-145]**

This transaction is currently in the [Prioritization of Worklists for Reporting \(POWR\)](#) Trial Implementation Supplement.